

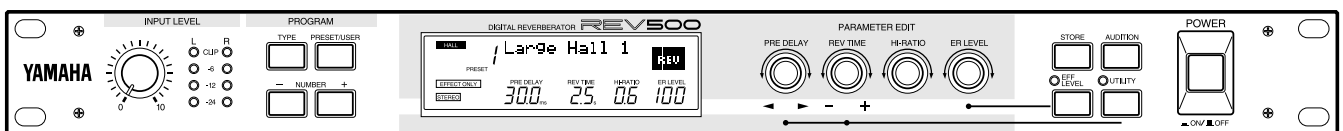

DIGITAL REVERBERATOR

REV500

Operation Manual
Manuel d'instructions
Bedienungsanleitung
Manual de Operación



FCC INFORMATION (U.S.A.)

1. IMPORTANT NOTICE: DO NOT MODIFY THIS UNIT!

This product, when installed as indicated in the instructions contained in this manual, meets FCC requirements. Modifications not expressly approved by Yamaha may void your authority, granted by the FCC, to use the product.

2. IMPORTANT: When connecting this product to accessories and/or another product use only high quality shielded cables. Cable/s supplied with this product MUST be used. Follow all installation instructions. Failure to follow instructions could void your FCC authorization to use this product in the USA.

3. NOTE: This product has been tested and found to comply with the requirements listed in FCC Regulations, Part 15 for Class "B" digital devices. Compliance with these requirements provides a reasonable level of assurance that your use of this product in a residential environment will not result in harmful interference with other electronic devices. This equipment generates/uses radio frequencies and, if not installed and used according to the instructions found in the users manual, may cause interference harmful to the operation of other electronic devices. Compliance with FCC regulations does not guarantee that interference will not occur in all installations. If this product is found to be the source of interference, which can be determined by turning the unit "OFF" and "ON", please try to eliminate the problem by using one of the following measures:

Relocate either this product or the device that is being affected by the interference.

Utilize power outlets that are on different branch (circuit breaker or fuse) circuits or install AC line filter/s.

In the case of radio or TV interference, relocate/reorient the antenna. If the antenna lead-in is 300 ohm ribbon lead, change the lead-in to coaxial type cable.

If these corrective measures do not produce satisfactory results, please contact the local retailer authorized to distribute this type of product. If you can not locate the appropriate retailer, please contact Yamaha Corporation of America, Electronic Service Division, 6600 Orangethorpe Ave, Buena Park, CA 90620

* This applies only to products distributed by YAMAHA CORPORATION OF AMERICA.

IMPORTANT NOTICE FOR THE UNITED KINGDOM

Connecting the Plug and Cord

WARNING: THIS APPARATUS MUST BE EARTHED

IMPORTANT: The wires in this mains lead are coloured in accordance with the following code:

GREEN-AND-YELLOW : EARTH

BLUE : NEUTRAL

BROWN : LIVE

As the colours of the wires in the mains lead of this apparatus may not correspond with the coloured markings identifying the terminals in your plug, proceed as follows:

The wire which is coloured GREEN-AND-YELLOW must be connected to the terminal in the plug which is marked by the letter E or by the safety earth symbol \perp or coloured GREEN-AND-YELLOW.

The wire which is coloured BLUE must be connected to the terminal which is marked with the letter N or coloured BLACK.

The wire which is coloured BROWN must be connected to the terminal which is marked with the letter L or coloured RED.

* This applies only to products distributed by YAMAHA KEMBLE MUSIC (U.K.) LTD.

ADVARSEL!

Lithiumbatteri–Eksplodingsfare ved fejlagtig håndtering. Udskiftning må kun ske med batteri af samme fabrikat og type. Levér det brugte batteri tilbage til leverandoren.

VARNING

Explosionsfara vid felaktigt batteribyte. Använd samma batterityp eller en ekvivalent typ som rekommenderas av apparattillverkaren. Kassera använt batteri enligt fabrikantens instruktion.

VAROITUS

Paristo voi räjähtää, jos se on virheellisesti asennettu. Vaihda paristo ainoastaan laitevalmistajan suosittelemaan tyyppiin. Hävitä käytetty paristo valmistajan ohjeiden mukaisesti.

NEDERLAND

- Dit apparaat bevat een lithium batterij voor geheugen back-up.
- Raadpleeg uw leverancier over de verwijdering van de batterij op het moment dat u het apparaat aan het einde van de levensduur afdankt of de volgende Yamaha Service Afdeling:

Yamaha Music Nederland Service Afdeling
Kanaalweg 18-G, 3526 KL UTRECHT
Tel. 030-2828425

- Gooi de batterij niet weg, maar lever hem in als KCA.

THE NETHERLANDS

- This apparatus contains a lithium battery for memory back-up.
- For the removal of the battery at the moment of the disposal at the end of the service life please consult your retailer or Yamaha Service Center as follows:

Yamaha Music Nederland Service Center
Address: Kanaalweg 18-G, 3526 KL UTRECHT
Tel: 030-2828425

- Do not throw away the battery. Instead, hand it in as small chemical waste.

Precautions

WARNING

Installation

- Connect this unit's power cord only to an AC outlet of the type stated in this Owner's Manual or as marked on the unit. Failure to do so is a fire and electrical shock hazard.
- Do not allow water to enter this unit or allow the unit to become wet. Fire or electrical shock may result.
- Do not place a container with liquid or small metal objects on top of this unit. Liquid or metal objects inside this unit are a fire and electrical shock hazard.
- Do not place heavy objects, including this unit, on top of the power cord. A damaged power cord is a fire and electrical shock hazard. In particular, be careful not to place heavy objects on a power cord covered by a carpet.

Operation

- Do not scratch, bend, twist, pull, or heat the power cord. A damaged power cord is a fire and electrical shock hazard.
- Do not remove the unit's cover. You could receive an electrical shock. If you think internal inspection, maintenance, or repair is necessary, contact your dealer.
- Do not modify the unit. Doing so is a fire and electrical shock hazard.
- If lightning begins to occur, turn off the power switch of the unit as soon as possible, and unplug the power cable plug from the electrical outlet.
- If there is a possibility of lightning, do not touch the power cable plug if it is still connected. Doing so may be an electrical shock hazard.

In case an abnormality occurs during operation

- If the power cord is damaged (i.e., cut or a bare wire is exposed), ask your dealer for a replacement. Using the unit with a damaged power cord is a fire and electrical shock hazard.
- Should this unit be dropped or the cabinet be damaged, turn the power switch off, remove the power plug from the AC outlet, and contact your dealer. If you continue using the unit without heeding this instruction, fire or electrical shock may result.
- If you notice any abnormality, such as smoke, odor, or noise, or if a foreign object or liquid gets inside the unit, turn it off immediately. Remove the power cord from the AC outlet. Consult your dealer for repair. Using the unit in this condition is a fire and electrical shock hazard.

CAUTION

Installation

- Keep this unit away from the following locations:
 - Locations exposed to oil splashes or steam, such as near cooking stoves, humidifiers, etc.
 - Unstable surfaces, such as a wobbly table or slope.

- Locations exposed to excessive heat, such as inside a car with all the windows closed, or places that receive direct sunlight.
- Locations subject to excessive humidity or dust accumulation.

- Hold the power cord plug when disconnecting it from an AC outlet. Never pull the cord. A damaged power cord is a potential fire and electrical shock hazard.
- Do not touch the power plug with wet hands. Doing so is a potential electrical shock hazard.

Operation

- Turn off all musical instruments, audio equipment, and speakers when connecting to this unit. Use the correct connecting cables and connect as specified.
- If you know you will not use this unit for a long period of time, such as when going on vacation, remove the power plug from the AC outlet. Leaving it connected is a potential fire hazard.

Maintenance

- To prevent electrical shock when cleaning the unit, remove the power plug from the AC outlet.
- The inside of the unit should be cleaned periodically. Dust accumulation inside the unit may cause malfunction and is a potential fire hazard. Consult your dealer for information about cleaning.

PRECAUTIONS FOR OPERATION - FOR CORRECT OPERATION -

Interference with other electronic devices

- The digital circuits of this unit may induce a slight noise into nearby radios and TVs. If noise occurs, relocate the affected equipment.

Backup battery

- The REV500 has a long-life lithium battery that maintains the contents of the user memory even when the REV500 is off. Under normal use, the battery should last several years. However, Yamaha strongly recommends that you have the battery replaced by a qualified Yamaha service center **every five years**, to prevent the accidental loss of valuable data.
- Should the battery's voltage fall below a certain level, the message "LOW BATTERY" will appear in the LCD when you turn the REV500 on. If this happens, it means that contents of your REV500's user memory have been lost. Have the backup battery replaced immediately.
- Prompt and regular replacement of the back-up battery is necessary to prevent the loss of important data. In addition, if possible, you should use the MIDI bulk dump function (see page 17) regularly to store backup copies of your REV500's data in a MIDI sequencer other MIDI device. This will allow you to recover your data should the back-up battery run down sooner than you think.

Introduction

Congratulations on your purchase of a Yamaha REV500 Digital Reverberator! The REV500 is a high-quality, inexpensive, and easy-to-use digital reverberator, suitable for home recording or smaller sound reinforcement applications.

A true stereo processor with two inputs and two outputs, the REV500 offers high-quality stereo reverb, either alone or in combination with a variety of other effects. The 20-bit A/D and D/A converters feature a 44.1 kHz sampling rate, for superb sound quality and wide frequency response. The REV500 comes complete with 100 preset programs that take excellent advantage of this high-performance hardware, plus room for 100 more programs that you can edit for yourself.

The REV500 is also flexible and simple to use. It lets you use either 1/4" phone or XLR connectors for both input and output, and gives you the option of +4 dB input and output levels. Four rotary controls allow quick and easy editing of the basic program parameters. And MIDI IN and OUT terminals allow remote program selection, remote data storage, and realtime control of program parameters using MIDI messages.

To get the most out of your REV500 Digital Reverberator, please read this manual thoroughly and keep it on hand for future reference.

Contents

Controls	1	System Functions	14
Front Panel	1	Selecting an Input Mode	14
Rear Panel	2	Selecting an Output Mode	14
Installation and Connections	2	Setting the Footswitch Function	14
Using the REV500	3	Adjusting the Audition Function	15
Selecting Programs	3	Changing the Initial Title Display	15
Testing Programs	3	Initializing the REV500's User Memory	15
Automatic Demonstration	3	Using MIDI Functions	16
REV500 Preset Program List	4	Selecting a MIDI Channel	16
Editing Programs	8	Using the MIDI OUT Function	16
Editing Basic Parameters	8	Editing the MIDI Program Change Map	16
Changing the Effect Level	9	Storing Data with MIDI Bulk Dumps	17
Realtime Parameter Control	9	Appendix	18
Editing Internal Parameters	9	Guide to Utility Mode Functions	18
Changing a Program's Title	9	Specifications	19
Internal Parameter List	10	Dimensions	20
Saving Edited Programs	13	MIDI Data Format	Add-1
		MIDI Implementation Chart	Add-3
		Program Data Sheet	Add-4

Controls

Front Panel

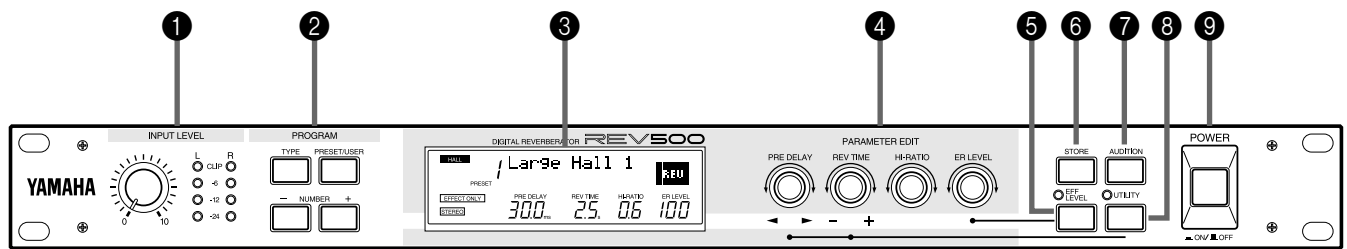

1 INPUT LEVEL control and meter

The INPUT LEVEL control sets the input level for both the right and left input channels. It is accompanied by a stereo LED meter that shows the levels of the signals received by the REV500 after A/D conversion. Lighting of the red CLIP LEDs thus indicates clipping of the digital signal. You should adjust the control so that the CLIP LEDs do not light.

2 PROGRAM keys

These keys let you choose the program that the REV500 will use to process the input sound.

The TYPE key selects the type of effect program to be used: HALL, ROOM, PLATE, or SPECIAL. The current program type selection is displayed in the upper left corner of the LCD.

The PRESET/USER key selects between the PRESET and USER program memory areas. The currently selected memory area is displayed under the program number in the LCD. It is possible to change the parameters of a preset program, but the edited program must be stored as a user program.

The NUMBER keys are used to select different programs within the chosen program type and memory area. The number and title of the currently selected program are displayed in the top row of the LCD.

3 LCD

This LCD normally displays information about the currently selected program. It also displays graphic information about basic parameters being edited, as well as a variety of other messages related to the REV500's utility functions.

4 PARAMETER EDIT controls

These controls let you edit the basic parameters of the selected program.

The PRE DELAY control sets the amount of time that will elapse before the onset of early reflections. It also functions as a **cursor** control, which you can turn to select the parameter or character to be modified when using the REV500's utility functions.

The REV TIME control sets the amount of time needed for the reverberation to decay. It also functions as a **data entry** control, which you can turn to change the values of selected items when using the REV500's utility functions.

The HI-RATIO control sets the reverb time for the high-frequency components of the reverb, as a proportion of the overall reverb time set using the REV TIME control.

The ER LEVEL control sets the level of the early reflection component of the reverb. It is also used, in combination with the EFF LEVEL key, to adjust the overall effect output level.

5 EFF LEVEL key and LED

This key lets you use the ER LEVEL control to set the overall effect output level. When the LED above this key is lit, the ER LEVEL control will adjust the effect level instead of the early reflection level.

6 STORE key

This key is used to store modified programs, and to execute MIDI bulk dumps.

7 AUDITION key

This key causes the REV500's internal tone generator to play a sound, allowing you to check the effect of the currently selected program. A utility function (see page 15) allows you to select one of two sounds for this key to play, and to set the REV500 to play this sound once or repeatedly when the AUDITION key is pressed.

8 UTILITY key and LED

This key lets you access the REV500's utility functions, which include MIDI settings and system-related functions. The LED above this key will light when a utility function is being used. See page 18 for a summary of the functions that can be accessed using this key.

9 POWER switch

This switch turns the REV500 on and off.

Rear Panel

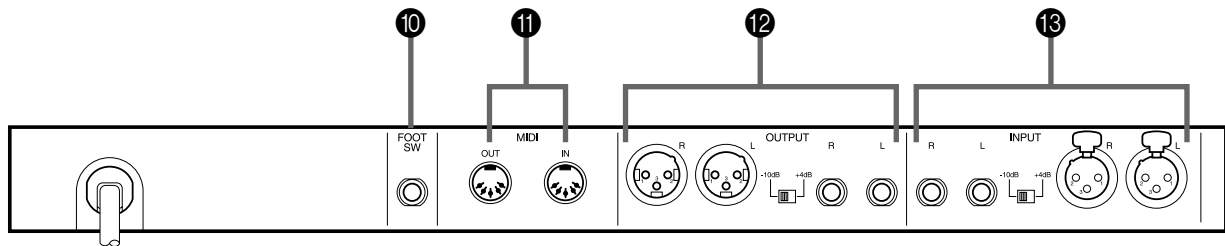

10 FOOT SW connector

This 1/4" phone jack allows you to connect a Yamaha FC5 footswitch, for hands-free remote control of your REV500. You can use the FC5 footswitch either to mute the REV500's effect output, or to advance the current program selection.

11 MIDI terminals

The REV500 sends and receives MIDI data via these connectors.

12 OUTPUT connectors and output level switch

These are balanced output jacks that output the analog return signal from the REV500 to your mixer, multitrack recorder, or other audio equipment. A pair of XLR connectors and a pair of 1/4" phone jacks are provided. If you desire monophonic output, insert the plug in the left (L) connector only. The output level switch selects either -10 dB or +4 dB as the nominal output level.

13 INPUT connectors and input level switch

These are balanced input jacks that receive the analog signal from your mixer, multitrack recorder, or other audio equipment. A pair of XLR connectors and a pair of 1/4" phone jacks are provided. If the sound source to be processed is monophonic, insert the plug in the left (L) connector only. Also, be sure to set the REV500 to use mono input (refer to page 14). The input level switch selects either -10 dB or +4 dB as the nominal input level.

Do not connect jacks to both the XLR and 1/4" phone INPUT connectors, as doing so may adversely affect the performance of the REV500.

Installation and Connections

Before attempting to use your REV500, make sure that you have carefully read and understood the precautions inside the front cover of this manual.

Mount the REV500 in a rack, or place it in a location where it is safe and stable. Make sure that the POWER switch is **off** before making any connections. Plug in the power cord, and connect the REV500's input and output connectors to your mixer, multitrack recorder, or other audio equipment using appropriate cables.

Press the POWER switch to turn the REV500 on.

Using the REV500

Selecting Programs

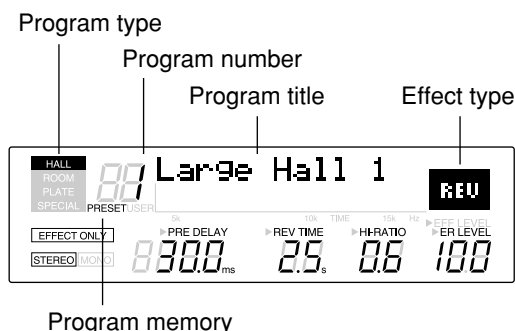

You can use the PROGRAM keys to select a desired program, as described below. (Note that the following steps do not have to be performed in the order listed.)

1. Select a program type.

Use the PROGRAM TYPE key to select a program type. The REV500 has four program types: HALL, ROOM, PLATE, and SPECIAL. Each program type contains 25 programs, as described in the REV500 Preset Program List on pages 4 through 7.

The current program type selection is displayed in the upper left corner of the LCD.

2. Select a program memory.

Press the PRESET/USER key to switch between the preset and user program memory areas. When you first use the REV500, you will find that both memory areas contain the same selection of programs. The contents of the USER memory will gradually change as you edit programs and store the results, as explained in the following chapter.

The currently selected memory area is displayed under the program number in the LCD.

3. Select a program number.

Use the PROGRAM NUMBER keys to choose one of the programs in the program type and memory area you have selected. You can press these keys once to increase or decrease the current program number selection by one, or hold them down to scan through the programs.

The number and title of the current program are displayed in the top row of the LCD.

The effect type of the current program is also displayed in the upper right corner of the LCD. (Refer to pages 10 through 13 for details regarding effect types.)

Testing Programs

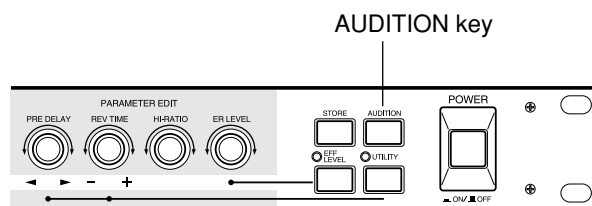

You can use the REV500's handy audition function to check the effect produced by a program when it's inconvenient to run your actual sound source through the REV500. Just press the AUDITION key in the upper right corner of the front panel. The REV500's internal tone generator will produce a tone that lets you hear how the program you've selected affects the output sound.

You can select one of two sample tones—either a snare drum or a rim shot—using the DEMO TONE TRIG utility function described on page 15. This function also lets you determine whether pressing the AUDITION key will cause the tone to sound once or repeatedly.

If you set the audition function to play repeatedly, you can stop it by pressing the AUDITION key a second time.

Automatic Demonstration

The REV500 has a demonstration mode that lets you hear samples of some typical effect settings. To select demonstration mode, hold down the UTILITY key and press AUDITION.

Important: If you select the demonstration mode while editing a program, the program will be reset and any changes you have made will be lost. Be sure to save important program data before selecting the demonstration mode. (Refer to page 13 for instructions on how to store a program.)

REV500 Preset Program List

HALL

No.	Title	Effect Type*	Description
1	Large Hall 1	REVERB	Standard hall-type reverbs that simulate large halls with good acoustics. May be used with any instrument. “Large Hall 1” is bright; “Large Hall 2” is slightly darker.
2	Large Hall 2		
3	Empty Hall	REVERB	A reverb that simulates the feel of a large hall with no audience.
4	Big Slap Hall	REVERB	A bright reverb with breadth, thanks to slightly emphasized early reflections.
5	Arena	REVERB	A reverb with the low-range characteristics of an arena-sized concert space.
6	New Hall	REVERB	A bright reverb with a punch.
7	Wonder Hall	REVERB	A light, bright hall reverb. Good with percussion.
8	Dark Hall	REVERB	A rather dark hall reverb. Recommended for use with songs in minor keys.
9	Church 1	REVERB	Reverbs that simulate the acoustics of high-vaulted cathedrals. “Church 1” is dark; “Church 2” is brighter, with more reflections.
10	Church 2		
11	Medium Hall 1	REVERB	Standard medium-sized hall reverbs. “Medium Hall 1” is bright, with many reflections; “Medium Hall 2” is dark and dense.
12	Medium Hall 2		
13	Concert Hall	REVERB	A hall-type reverb with natural-sounding acoustics.
14	Small Hall 1	REVERB	Reverbs that simulate acoustically ideal small halls. “Small Hall 1” is bright and live-sounding; “Small Hall 2” is somewhat darker.
15	Small Hall 2		
16	Gothic Hall	REV+CHO	A hall reverb with a growling chorus attack. Good for vocals and solo instruments.
17	Ballade Voc 1	REVERB	Longish hall reverbs for use with slow vocals. “Ballad Voc 1” is bright and dense; “Ballad Voc 2” is dark and slightly less dense.
18	Ballade Voc 2		
19	Rev for Pads	REV→FLG	A long reverb with flanged high ranges, for a spacy sound. Good with pad-type synths.
20	Ensemble Rev	REV→FLG	A short reverb with a warm flanger sound. Good for strings and organs.
21	Chorus Reverb	REV→CHO	A hall reverb with chorus added for extra thickness. Good with pianos and pad-type synths.
22	Slapped Echo	ECHO→REV	A reverb that captures the feel of an analog delay or tape echo. Good with vocals or solos.
23	Flutter Hall	REV→GATE	A gated hall reverb with a long pre-delay.
24	Kick Gate	REV→GATE	A gated hall reverb, intended for use with bass drums.
25	Snare Gate	REV→GATE	A gated hall reverb, intended for use with snare drums.

* Refer to pages 10 through 13 for details regarding effect types.

ROOM

No.	Title	Effect Type*	Description
1	Large Room 1	REVERB	A reverb that simulates a large room with hard walls, for a slightly quirky thick sound.
2	Large Room 2	REVERB	A large room reverb, slightly drier than “Large Room 1.”
3	Live Gate Room	REVERB	A room reverb with a very live nonlinear sound. Good with drums and guitars.
4	Live Room 1	REVERB	Reverbs that simulate the sound of a room with live acoustics. Use “Live Room 1” to simulate greater distance from the sound source, or “Live Room 2” for front-row seats.
5	Live Room 2		
6	Bath Room	REVERB	A simulation of the reverb in a tile-walled bathroom.
7	Medium Room	REVERB	A live-sounding reverb with the feel of a medium-sized recording studio.
8	Garage	REV→GATE	A reverb that simulates the sound of a garage performance.
9	Ring Studio	REVERB	The nonlinear reverb sound of a small studio with emphatic high-range acoustics.
10	Empty Store	REVERB	A reverb simulating a room with nothing in it.
11	Add to Dry Mix	REVERB	A room reverb that can add live sound to a dry two-channel mix source.
12	Heavy Bottom	REVERB	A room reverb with an emphasized low range, for a powerful sound.
13	Bright Room 1	REVERB	A bright room reverb with extra early reflections.
14	Bright Room 2	REVERB	A room reverb that sounds smaller, but more dense, than “Bright Room 1.”
15	Small Room	REVERB	A standard small room simulation.
16	Tiny Gate Room	REVERB	A somewhat dead nonlinear small room simulation.
17	Wood Room	REVERB	A small room simulation, dark and dead.
18	Compact Room	REV→DFILT	A very small room, simulated with short reverb and a dynamic filter.
19	Soft Space	REV+CHO	A short reverb with chorus. Adds a soft ambiance to drums, solos, and vocals.
20	Room Ambience	REVERB	Slightly coarse echo room simulations. Good for vocals and solo instruments.
21	Echo Vocal		
22	Tunnel 1	REVERB	Reverbs that simulate the acoustics inside a long tunnel. “Tunnel 2” is darker than “Tunnel 1.”
23	Tunnel 2		
24	Opera	REVERB	Reverbs that simulate large rooms with marble walls. “Opera” is bright, whereas “Cathedral” is dark.
25	Cathedral		

* Refer to pages 10 through 13 for details regarding effect types.

PLATE

No.	Title	Effect Type*	Description
1	Basic Plate	REVERB	A simulation of a metal plate echo effect.
2	Beauty Plate	REVERB	A bright, highly dense plate reverb.
3	LA Plate	REVERB	The bright, transparent plate sound that is popular on the West Coast.
4	Delayed Spring	REVERB	A spring reverb simulation with a longish pre-delay.
5	Fat Plate	REVERB	A rather coarse reverb with extra low-range energy. Good with vocals and solos.
6	Light Plate	REVERB	A bright, light plate sound.
7	Thin Plate	REVERB	The plate echo that would be created by an extremely thin metal plate.
8	Rev with Tail	REVERB	Complex reverb with a sub-reverb tail (when INPUT SELECT is set to L-MONO).
9	Short Plate	REVERB	A short, somewhat dark plate reverb.
10	Perc. Plate 1	REVERB	A short, bright plate reverb for percussion. Adjust the pre-delay to match the tempo.
11	Perc. Plate 2	REVERB	A short, light-sounding reverb. Perfect for cymbals.
12	Long Plate 1	REVERB	Three longish plate reverbs, each of which features different high-range characteristics.
13	Long Plate 2		
14	Long Plate 3		
15	Vocal Plate 1	REVERB	A plate reverb for use with vocals. Designed for ballads and other slow songs.
16	Vocal Plate 2	REVERB	A slightly darker-sounding reverb than “Vocal Plate 1.”
17	Vocalse	REV+CHO	A slightly chorused reverb. Good with guitars and keyboards.
18	Live Plate	ECHO→REV	An echo/reverb combination for vocals and solo instruments during live performances.
19	Industrial Rev	REVERB	A short plate reverb with a chopped low range. Good with analog rhythm machines, etc.
20	Strings Space	REVERB	Plate reverbs with very long reverb times. “String Space” is bright with a broad bandwidth, whereas “Cave” is dark with heavy low-range components. Good for pad synths.
21	Cave		
22	Super Long	REVERB	A plate reverb with a very long tail (when INPUT SELECT is set to L-MONO).
23	Mod Plate	REV→SYM	A reverb with symphonic effect. Good for guitars and keyboards.
24	Water Reverb	REV→FLG	A slightly flanged long reverb. Beautiful used with guitar arpeggios, etc.
25	Gate Plate	REV→GATE	A plate reverb with a gate envelope. Good with snare drums and such.

* Refer to pages 10 through 13 for details regarding effect types.

SPECIAL

No.	Title	Effect Type*	Description
1	Flange Room	REV→FLG	A short reverb combined with a flanger. Good with organs, strings, etc.
2	Reverb Chorus	REV+CHO	Short reverbs combined with chorus. The longer pre-delay of “Chorus Circles” emphasizes the sense of separation between the reverb and chorus effects.
3	Chorus Circles		
4	Rez Sweep Hall	REV→RESO	A flanger-like effect with a resonance point that varies with the input level.
5	Shadow Reverb	REV→RESO	A reverb with the resonance point set at E.
6	Sweep Reverb	REV→FLG	Four variations on the reverb/flanger theme. The flanger effect becomes more pronounced as the program number increases.
7	Rev Flange 1		
8	Rev Flange 2		
9	Heavy Flange		
10	Pan Reverb	REV→TRM	Five combinations of reverb and tremolo. The tremolo becomes faster as the program number increases. “Shake Shake” and “Sample & Hold” use square wave modulation for a pronounced tremolo effect. Adjust the tremolo speed to suit the song.
11	Rev Tremolo		
12	Skinny Plate		
13	Shake Shake		
14	Sample & Hold		
15	Pan Feedback	ECHO→REV	An echo with more feedback further away from stereo center. (Use with INPUT SELECT set to STEREO.)
16	Long Echo	ECHO→REV	An effect that combines a repeat delay with a short reverb.
17	Dyna Filter 1	REV→DFIL	Effects that change the sound depending on the input level; turns acoustic drums into synth drums. “Dyna Filter 1” has a long decay; “Dyna Filter 2” has a short decay. “Dyna Filter 3” uses the resonator, for a different effect.
18	Dyna Filter 2		
19	Dyna Filter 3	REV→RESO	
20	Backward	REV→CHO	An attempt at a reverse gate effect. Good with drums and guitars.
21	Industry	REVERB	A special effect that uses the maximum pre-delay and early reflection settings.
22	Natural Gate	REV→GATE	Four gated reverb variations. Change the hold time and gate level as needed for the best effect.
23	Drum Fizz Gate		
24	Techno Gate		
25	Gate for Loop		

* Refer to pages 10 through 13 for details regarding effect types.

Editing Programs

Editing Basic Parameters

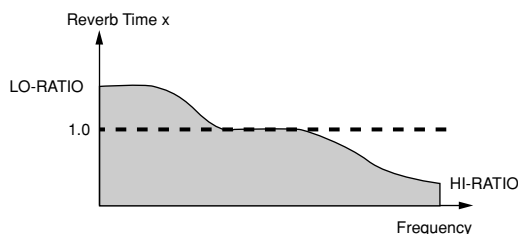
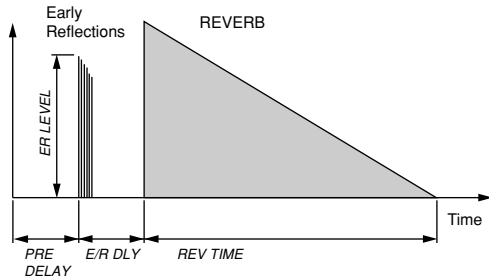
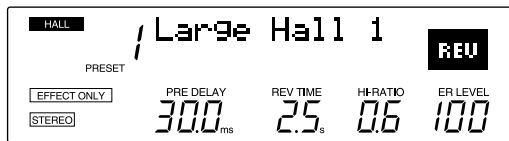

The four PARAMETER EDIT controls on the REV500's front panel let you adjust the basic program parameters quickly and easily. When you rotate one of these controls, the program information in the LCD (shown above) will be replaced by a graphic display indicating how the changes you've made have affected the parameter in question. (The display will return to normal a few moments after you stop turning the control.)

Please note that you must save any changes you make before you select another program or turn off the REV500; if you fail to do so, your edited program will be lost. Refer to page 13 for instructions on how to store a program.

PRE DELAY

This control sets the length of the initial delay that will pass before the reverb effect (including early reflections) begins. You can set a delay from 0.0 ms to 200.0 ms (or 299.9 ms if the ECHO→REV effect type is selected).

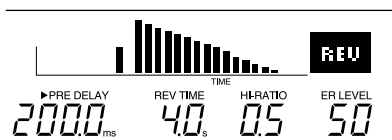
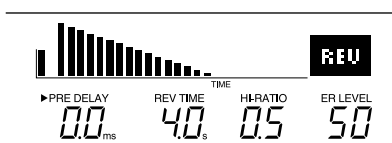

REV TIME

This control sets the length of the main reverberation. Possible reverb time values range from 0.3 to 99 seconds.

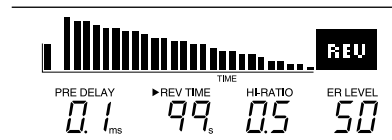
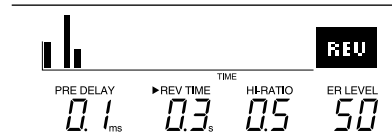

HI-RATIO

This control sets the reverb time for the high-frequency component of the reverb effect as a proportion of the overall reverb length (REV TIME parameter). Possible values are 0.1 to 1.0.

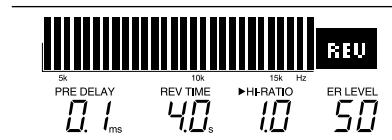
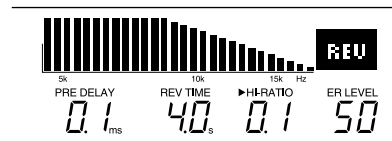

ER LEVEL

This control sets the level of the early reflections (i.e., the initial reflections that precede the main reverberation). You can set early reflection levels ranging from 0 to 100.

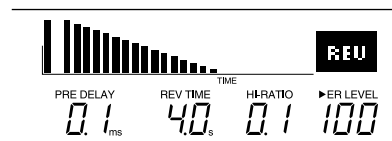
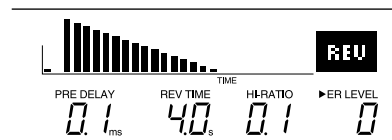

Changing the Effect Level

You can also use the ER LEVEL control to adjust the effect level, that is, the level of the total effect output. To do so, press the EFF LEVEL key before turning the ER LEVEL control. The LED above this key will light, and (as with the other basic parameters) the program information in the LCD will be replaced by a graphic display. You can set a level from 0 to 100.

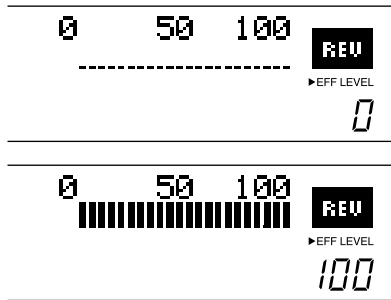

Realtime Parameter Control

The REV500 also lets you dynamically change the aforementioned basic parameters in realtime, using MIDI Control Change messages. The controller numbers for these parameters are shown in the table below.

MIDI Controller Numbers

Parameter	Ctrl. No.
PRE DELAY	12
REV TIME	13
HI-RATIO	14
ER LEVEL	15
EFF LEVEL	16

Editing Internal Parameters

In addition to the basic parameters described previously, the REV500's programs have a variety of internal parameters that can also be edited.

To edit a program's internal parameters, press the UTILITY key. If necessary, press the UTILITY key again until the INT. PARAMETER display appears:

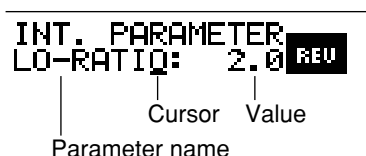

Use the PRE DELAY control to move the cursor from the parameter name to the parameter value and vice-versa. Use the REV TIME control to select the parameter you wish to edit, and to adjust the value assigned to the parameter you select.

Please note that the parameters available for editing will vary with the effect type of the program you have selected. You can identify the effect type of a program by checking the upper right corner of the LCD.

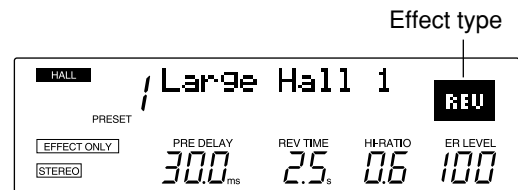

Refer to the next section for a list of the internal parameters for each effect type.

When you are done editing internal parameters, press one of the PROGRAM keys to exit the utility mode. Remember that (as with other program parameters) you must save the program you have just edited before selecting another program or turning the REV500 off, or your changes will be lost. Refer to page 13 for instructions on how to store a program.

Changing a Program's Title

You can assign a program you have edited a new title, for easy recognition.

To edit a program's title, begin by pressing the UTILITY key. The LED above this key will light, and one of the REV500's utility function displays will appear in the LCD. If necessary, press the UTILITY key again until the TITLE EDIT display appears:



Use the PRE DELAY control to select a character you wish to change, and the REV TIME control to change that character. Repeat this process until the title appears as you wish it to read.

When you are done editing the title, press one of the PROGRAM keys to exit the utility mode. Remember that (as with other program parameters) you must save the program you have just edited before selecting another program or turning the REV500 off, or your new title will be lost. Refer to page 13 for instructions on how to store a program.

Internal Parameter List

This section contains lists of the internal parameters for each effect type, together with a block diagram illustrating how the effect works. Since it is also possible to control internal parameters in realtime using MIDI Control Change messages, the corresponding controller numbers are also included in the lists.

COMMON

The internal parameters in the following table are common to all effect types.

Parameter	Ctrl. No.	Range	Description
LO-RATIO	17	0.1 — 2.4	Low frequency reverb time, proportional to REV TIME
DIFFUS	18	0 — 10	Spread of reverb sound
HPF	19	THRU, 20 — 1.0k [Hz]	Cutoff frequency of high pass filter
LPF	20	THRU, 500 — 20k [Hz]	Cutoff frequency of low pass filter

REVERB **REV**

The parameters in the following table are available for simple reverb effects.

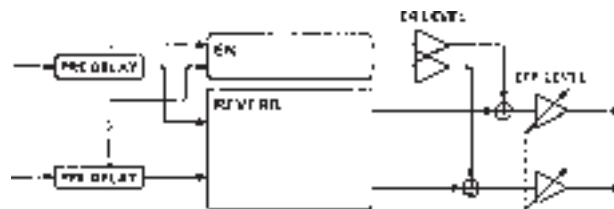

Parameter	Ctrl. No.	Range	Description
DENSITY	21	0 — 100 [%]	Density of reverberation
LIVENESS	22	0 — 10	Early reflection decay characteristics (0 = dead, 10 = live)
E/R DLY	23	0.0 — 100.0 [ms]	Delay from start of early reflections to start of reverb

REVERB → GATE **REV-GATE**

In this effect type, the output from the reverb is fed into a gate.

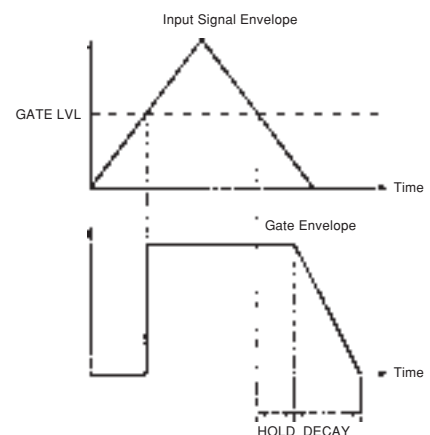
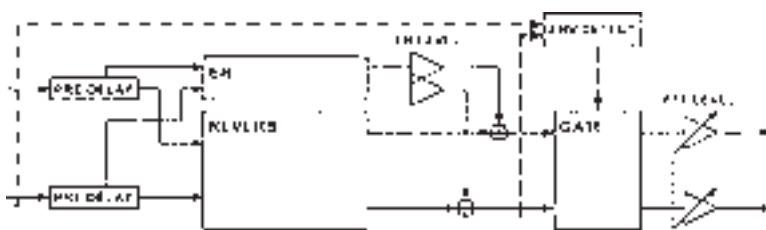

Parameter	Ctrl. No.	Range	Description
GATE LVL	24	-60 — 0 [dB]	Gate threshold level
HOLD	25	1 — 5759 [ms]	Time from hold time that the gate remains open
DECAY	26	1 — 24000 [ms]	Time needed for gate to close completely
DETECT	27	PRE, POST	Point at which threshold level is detected

REVERB → RESONATOR

**REV-
RESO**

In this effect type, the output from the reverb is fed into a resonator.

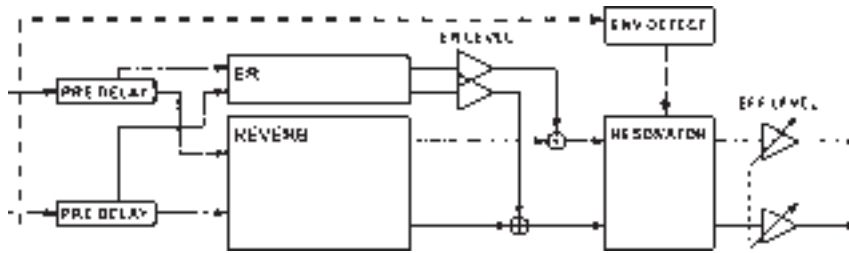

Parameter	Ctrl. No.	Range	Description
SENS	28	1 – 10	Sensitivity of the resonator input signal
RESO	29	0 – 100 [%]	Resonator feedback level
DECAY	30	6 – 24000 [ms]	Speed of resonance point return to lowest frequency
MIX	31	0 – 100 [%]	Balance of reverb direct output and resonator output

REVERB → DYNAMIC FILTER

**REV-
DFILT**

In this effect type, the output from the reverb is fed into a dynamic filter.

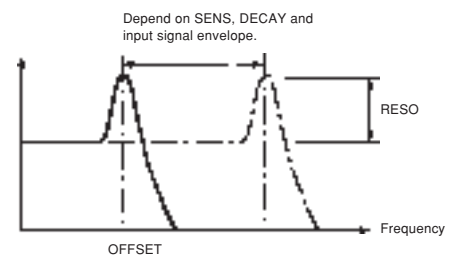
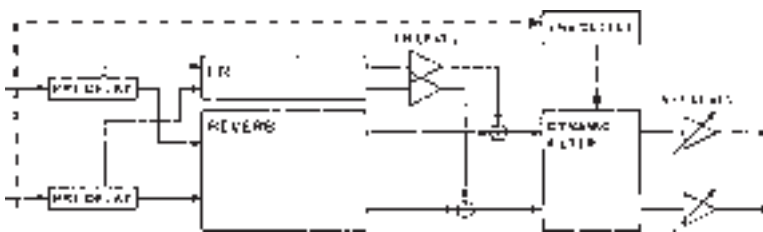

Parameter	Ctrl. No.	Range	Description
SENS	70	0 – 10	Low frequency reverb time, proportional to REV TIME
OFFSET	71	0 – 64	Offset from the minimum of the cutoff frequency
RESO	72	0 – 20	Degree of filter resonance
DECAY	73	6 – 24000 [ms]	Speed of cutoff level return to minimum

REVERB + CHORUS



This effect type, the source sound is processed separately by both the reverb and a chorus effect. The results of this parallel processing are then mixed for output.

Note that in this effect type, the LPF and HPF (see COMMON parameters, above) are applied immediately before the PRE DELAY. Hence, these filters do not affect the sound processed by the chorus effect.

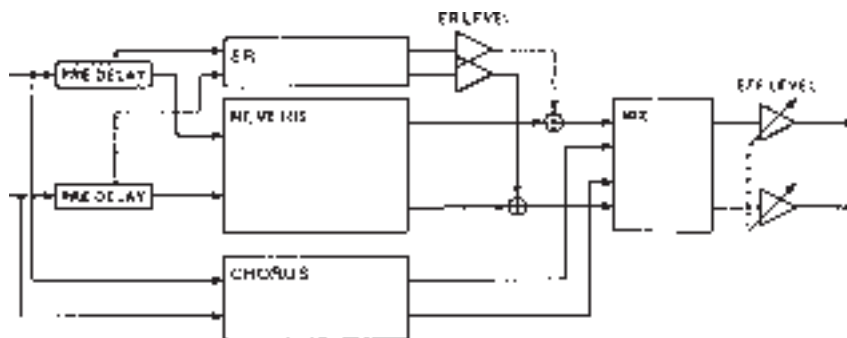

Parameter	Ctrl. No.	Range	Description
SPEED	74	0.05 — 10.00 [Hz]	Modulation frequency
DEPTH	75	0 — 100 [%]	Modulation depth
MIX	77	0 — 100 [%]	Cutoff frequency of low pass filter

REVERB → CHORUS, FLANGER or SYMPHONIC



In these effect types, the output from the reverb is fed into a chorus, flanger, or symphonic effect.

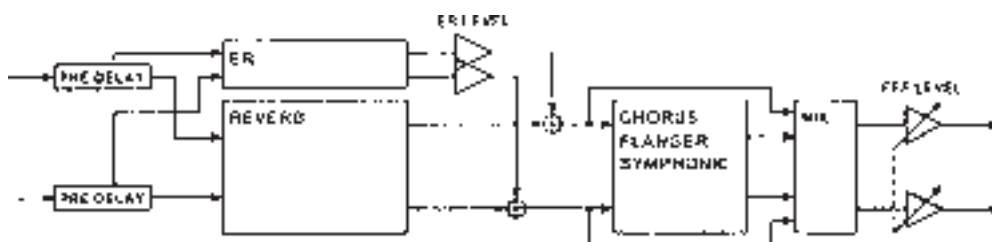

Parameter	Ctrl. No.	Range	Description
SPEED	74	0.05 — 10.00 [Hz]	Modulation frequency
DEPTH	75	0 — 100 [%]	Modulation depth
FB LVL	76	0 — 100 [%]	Feedback level (REVERB → FLANGER effects only)
MIX	77	0 — 100 [%]	Cutoff frequency of low pass filter

REVERB → TREMOLO

In this effect type, the output from the reverb is fed into a tremolo effect.

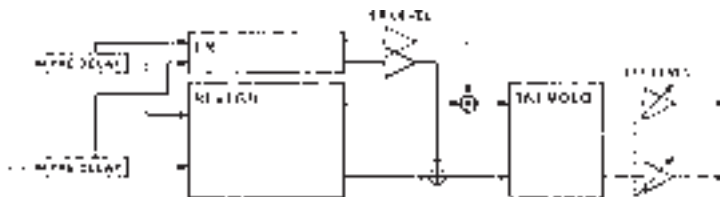

Parameter	Ctrl. No.	Range	Description
SPEED	78	0.05 — 10.0 [Hz]	Modulation frequency
DEPTH	79	0 — 100 [%]	Modulation depth
PHASE	80	0 — 354.4 [°]	Phase difference between right and left channels
WAVE	81	SINE, TRI, SQR	Waveform used by low frequency oscillator

ECHO → REVERB

In this effect type, the output of the reverb's PRE DELAY block is fed back into the reverb input to produce an echo effect.

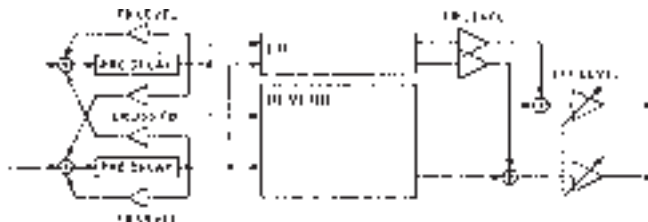

Parameter	Ctrl. No.	Range	Description
FB LVL	82	-100 — +100 [%]	Level of feedback to own channel
CROSS FB	83	-100 — +100 [%]	Level of feedback to opposite channel

Saving Edited Programs

You must save the programs you have edited before selecting a different program or turning off the REV500, or the changes you make will be lost.

To save a program, press the STORE key. The program number in the LCD will begin to flash, and the REV500 will ask you if it's okay to store the program. (If you are editing a preset program, the memory area indicator under the program number will automatically change to USER.)

If you want to save your program under a different program number, use the PROGRAM NUMBER keys to change the program number. (You cannot change the program type, however.) Press STORE a second time when you are sure you're ready to save the program, and the REV500 will comply.

If you decide you'd rather not store the program after all, simply press the PROGRAM TYPE key or the PRESET/USER key, and the display will return to normal.

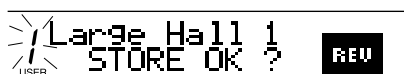

System Functions

Selecting an Input Mode

If you will be using the REV500 to process monophonic input (from the left input connector), you must use the INPUT SELECT function to inform it of this fact.

To change the input mode, first press the UTILITY key. If necessary, press the UTILITY key again until the INPUT SELECT display appears:

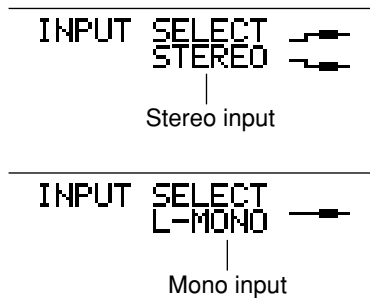

Use the REV TIME control to switch between the STEREO and L-MONO input settings. When you have made your setting, press one of the PROGRAM keys to exit the utility mode.

Selecting an Output Mode

You can set the REV500 to output the processed effect signal only, or a mixture of the both direct output and the processed signal. (If you elect to add the direct signal, the balance between the direct and effect output signals will be determined by the EFF LEVEL setting.)

To change the output mode, first press the UTILITY key. If necessary, press the UTILITY key again until the OUTPUT MODE display appears:

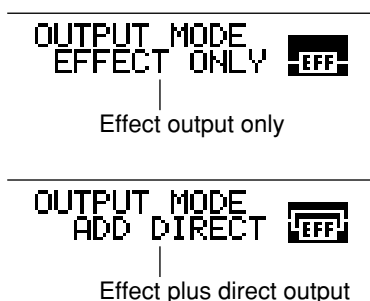

Use the REV TIME control to switch between the EFFECT ONLY and ADD DIRECT output mode settings. When you have made your setting, press one of the PROGRAM keys to exit the utility mode.

Setting the Footswitch Function

You can use an FC5 footswitch with your REV500, for hands-free control of one of two functions frequently required during live performances. You can use the footswitch either to mute the REV500's effect output, or to advance the current program selection.

You can select which of these two roles the footswitch will perform using a utility function. To access this function, press the UTILITY key. The LED above this key will light, and one of the REV500's utility function displays will appear in the LCD. If necessary, press the UTILITY key again until the FOOT SWITCH display appears:

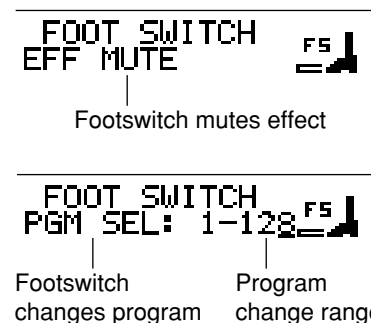

Use the REV TIME control to switch between the EFF MUTE and PGM SEL functions. If you select the former, the REV500's effect output will be suppressed when you depress the footswitch. Depress the footswitch again to release the effect mute.

If you select the latter function, depressing the footswitch will cause the current program selection to advance in the order specified by the MIDI program change map (see page 16). This function also lets you adjust the range of MIDI program change numbers that the footswitch can select. Use the PRE DELAY control to move the cursor from PGM SEL to the range setting, then use the REV TIME control to adjust the upper value of this setting (which may be anywhere from 1 to 128). The footswitch will advance the current program selection until it reaches the program change number you have set. Depressing the footswitch again will return the program change number to 1.

When you have made your settings, press one of the PROGRAM keys to exit the utility mode.

Adjusting the Audition Function

The REV500 lets you customize the audition function to suit your needs. You can select one of two tones: either a snare drum or a rim shot. You can also specify whether pressing the AUDITION key will play the selected tone once, or start it playing repeatedly. You can also turn the function off, to prevent the REV500 from producing unwanted sounds if this key is pressed accidentally.

To adjust the audition function, first press the UTILITY key. If necessary, press the UTILITY key again until the DEMO TONE TRIG display appears:

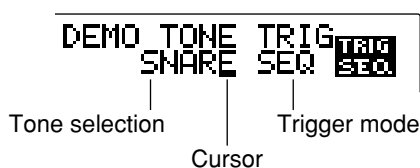

Use the PRE DELAY control to move the cursor from the tone selection parameter to the trigger mode parameter, and vice-versa. Use the REV TIME control to select the desired tone (SNARE or RIM), or the desired trigger mode (OFF, ONCE, or SEQ).

When you are satisfied with your settings, press one of the PROGRAM keys to exit the utility mode.

Changing the Initial Title Display

This utility function lets you personalize your REV500 by entering a short message that will be displayed briefly when you turn on the power. This message can consist of two lines of up to 14 characters each.

To edit this initial title display, begin by pressing the UTILITY key. If necessary, press the UTILITY key again until the INI TITLE 1/2 display appears:

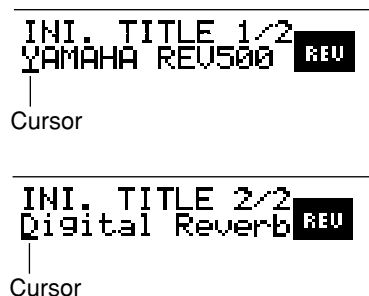

This display is used to edit the first line of the initial title. Use the PRE DELAY control to select a character you wish to change, and the REV TIME control to change that character. Repeat this process until the line appears as you wish it to read.

When you are satisfied with this line of your startup message, press the UTILITY key a second time to display the INI TITLE 2/2 display. Repeat the process to edit the second line.

When you are done editing the initial title, press one of the PROGRAM keys to exit the utility mode.

Initializing the REV500's User Memory

At some point you may wish to clear the edited programs out of your REV500's user memory and restore it to factory condition. The method for doing this is as follows:

Hold the STORE key down as you turn the POWER switch on. The REV500 will instruct you to press the STORE key a second time to initialize its memory. Press the STORE key to go ahead with the initialization, or any other key if you decide you don't want to.

Please be aware that this procedure will initialize any system settings and MIDI settings (such as the MIDI program change map) as well as the contents of the user memory area.

Using MIDI Functions

Selecting a MIDI Channel

You can change the MIDI channel that the REV500 uses to transmit and receive data. First, press the UTILITY key. If necessary, press the UTILITY key again until the MIDI CHANNEL display appears:

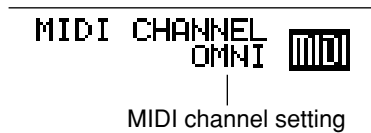

Use the REV TIME control to select the desired MIDI channel. You can set the REV500 to use any of channels 1 through 16, or select OMNI for all channels. You can also select OFF to disable MIDI communication.

When you have made your setting, press one of the PROGRAM keys to exit the utility mode.

Using the MIDI OUT Function

This function determines whether MIDI channel messages received at the MIDI IN terminal will be echoed through to the MIDI OUT terminal. You should turn this function on when you want to connect two or more REV500s in a “daisy chain” so they can be controlled by a single master device such as a sequencer or keyboard.

Begin by pressing the UTILITY key. If necessary, press the UTILITY key again until the MIDI OUT display appears:

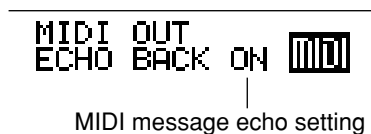

Use the REV TIME control to select between the ECHO BACK ON and ECHO BACK OFF settings. If you choose ECHO BACK ON, the MIDI channel messages received at the MIDI IN terminal will be echoed through to the MIDI OUT terminal. (Other messages received at the MIDI IN terminal will not be echoed.)

When you have made your setting, press one of the PROGRAM keys to exit the utility mode.

Editing the MIDI Program Change Map

The REV500 has a MIDI program change map that assigns REV500 programs to MIDI program change numbers. This feature facilitates remote selection of REV500 programs (which are stored in eight banks numbered 1 through 25) using MIDI Program Change messages (which can specify program numbers from 1 through 128).

To edit the MIDI program change map, first press the UTILITY key. If necessary, press the UTILITY key again until the MIDI PGM TABLE display appears:

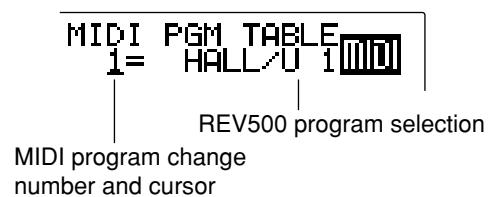

Use the PRE DELAY control to move the cursor to the MIDI program change number, and the REV TIME control select a program change number whose program assignment you want to change. Then move the cursor back to the REV500 program selection, and use the REV control again to select the program that you want the REV500 to use when it receives the selected program change number.

Repeat this process to change as many MIDI program change assignments as you like. When you are done editing the program change map, press one of the PROGRAM keys to exit the utility mode.

If you are using a Yamaha FC5 footswitch with the REV500’s footswitch utility function set to PGM INC/DEC, depressing the footswitch will select REV500 programs sequentially in the order specified by this MIDI program change map.

Storing Data with MIDI Bulk Dumps

The REV500 is capable of transmitting its data as bulk dumps, for storage in a sequencer or other MIDI device. To use this function, first make sure that the REV500 is properly connected to the device that is to receive the data, and that the MIDI channels of the two devices match.

Next, press **UTILITY**. If necessary, press the **UTILITY** key again until the **MIDI BULK DUMP** display appears:

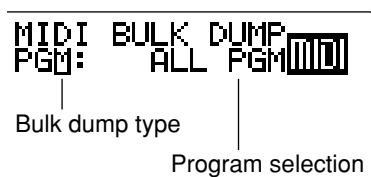

Use the **REV TIME** control to select the type of bulk dump to be transmitted. The REV500 is capable of sending four types of bulk data:

MIDI Bulk Dumps

Dump Type	Data transmitted
ALL	All data (system setup data, all user programs, and program table data)
SYSTEM	All system setup data
PGM	Data for all programs, or data for a single specified program
PGM TABLE	MIDI program table data

If you select **PGM** as the bulk dump type, you must select the program to be dumped. Use the **PRE DELAY** control to move the cursor to the program selection, and the **REV TIME** control to change the setting. If you select **ALL PGM**, the REV500 will send the data for all user programs as a single dump. You may also select a single user program and store it externally using an individual data dump.

When you are satisfied with your selection, press the **STORE** key. The REV500 will execute the data dump.

When you are finished transmitting data, press one of the **PROGRAM** keys to exit the utility mode.

Appendix

Guide to Utility Mode Functions

The following table briefly describes the functions that can be accessed using the UTILITY key. Each function is listed in order of appearance. The number to the right of the function's description indicates the page of this manual where you will find instructions on use of the function.

Utility Mode Functions

Function	Type	Description	Page
INT. PARAMETER	Program edit	Used to edit the internal parameters of the currently selected program.	9
TITLE EDIT	Program edit	Allows editing of the title of the currently selected program.	9
INPUT SELECT	System setting	Sets the REV500 to use either mono or stereo input	14
OUTPUT MODE	System setting	Switches between effect output only and effect output plus direct source output	14
FOOT SWITCH	System setting	Selects the REV500 function that can be controlled by a connected footswitch	14
MIDI CHANNEL	System setting (MIDI)	Sets the MIDI channel that the REV500 will use to receive and send MIDI data	16
MIDI THRU	System setting (MIDI)	Sets whether the MIDI OUT terminal will act as a MIDI OUT or merged MIDI THRU	16
MIDI PGM TABLE	System setting (MIDI)	Assigns REV500 programs to MIDI Program Change numbers	16
MIDI BULK DUMP	MIDI utility	Transmits REV500 program or system setting data to another MIDI device	17
DEMO TONE TRIG	System setting	Sets the tone and trigger mode for the REV500's audition function.	15
INI TITLE 1/2	System setting	Allows editing of the first line of the initial title message displayed at startup	15
INI TITLE 2/2	System setting	Allows editing of the second line of the initial title message displayed at startup	15

Specifications

ELECTRICAL CHARACTERISTICS

Frequency Reponse	20 Hz to 20 kHz (+1.0 dB, -2.0 dB)
Dynamic Range	96 dB typical
Distortion	Less than 0.03% (1 kHz, max level)

INPUT

Number of Channels	2 (phone or XLR jack)
Nominal Level	+4 or -10 dB (selected by rear panel switch)
Impedance	20 k

OUTPUT

Number of Channels	2 (phone or XLR jack)
Nominal Level	+4 or -10 dB (selected by rear panel switch)
Impedance	150

AD/DA CONVERSION

AD Conversion	20 bit (64X oversampling)
DA Conversion	20 bit (8X oversampling)
Sampling Frequency	44.1 kHz

PROGRAM MEMORY

Memory areas	PRESET (read-only), USER (read/write)
Memory configuration	Four program types (HALL, ROOM, PLATE, SPECIAL) with 25 programs per type.

FRONT PANEL

Switches	PROGRAM TYPE, PRESET/USER, PROGRAM NUMBER -, PROGRAM NUMBER +, EFF LEVEL, STORE, AUDITION, UTILITY, POWER
Rotary Controls	INPUT LEVEL, PRE DELAY, REV TIME, HI-RATIO, ER LEVEL
Display	Stereo input level LED (-24, -12, -6, CLIP), LCD, EFF LEVEL LED, UTILITY LED

REAR PANEL

Connectors	INPUT L/R (1/4" phone), INPUT L/R (XLR), FOOT SW (1/4" phone), OUTPUT L/R (1/4" phone), OUTPUT L/R (XLR), MIDI IN, MIDI OUT
Switches	Input level selector, output level selector

POWER REQUIREMENTS

USA and Canada	120V AC, 60 Hz
General	230V AC, 50 Hz

POWER CONSUMPTION

15W

PHYSICAL

Dimensions (W x H x D)	480 mm x 45 mm x 227.9 mm
Weight	3.5 kg

OPTION

Footswitch FC5

Dimensions

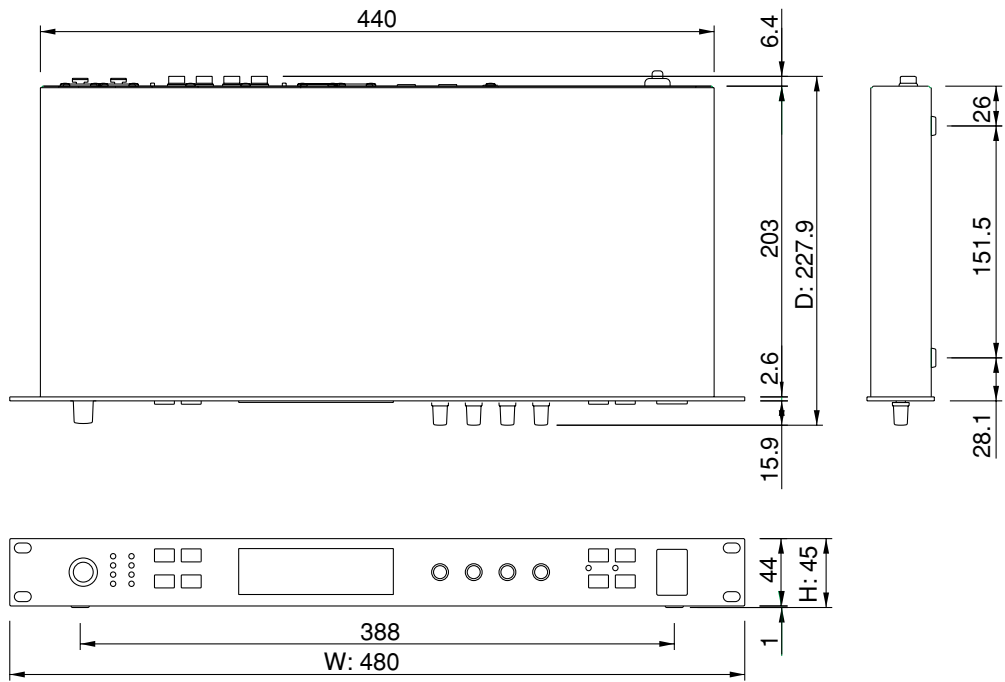

Unit: mm

For European Model

Purchaser/User Information specified in EN55103-1 and EN55103-2.

Inrush Current: <1A

Conformed Environment: E1, E2, E3 and E4

MIDI data format

1. Transmitted data

1-1. System information

#1 Program bulk data

```

status      1111 0000(F0H) System exclusive
ID No.     0100 0011(43H) YAMAHA
sub status  0000 nnnn(0nH) n = 0 - 15
format no. 0111 1110(7EH)
byte count 0000 0000(00H)
byte count 0100 1000(48H)
           0100 1100(4CH) "L"
           0100 1101(4DH) "M"
           0010 0000(20H) Space
           0010 0000(20H) Space
           0011 1000(38H) "8"
           0100 0001(41H) "A"
           0011 1001(39H) "9"
           0011 1001(39H) "9"
data name  0100 1101(4DH) "M"
program no. 0mmm mmmm m = 1 - 100
data      0000 dddd Memory bulk
           (62 bytes)
           :
           :
           0000 dddd
check sum 0eee eeee
EOX       1111 0111(F7H) End of exclusive
    
```

#2 Program Change Table bulk data

```

status      1111 0000(F0H) System exclusive
ID No.     0100 0011(43H) YAMAHA
sub status  0000 nnnn(0nH) n = 0 - 15
format no. 0111 1110(7EH)
byte count 0000 0010(02H)
byte count 0000 1010(0AH)
           0100 1100(4CH) "L"
           0100 1101(4DH) "M"
           0010 0000(20H) Space
           0010 0000(20H) Space
           0011 1000(38H) "8"
           0100 0001(41H) "A"
           0011 1001(39H) "9"
           0011 1001(39H) "9"
data name  0101 0100(54H) "T"
bank no.   0000 0001(01H)
data      0000 dddd Program change
           data (256 bytes)
           :
           :
           0000 dddd
check sum 0eee eeee
EOX       1111 0111(F7H) End of exclusive
    
```

#3 System Setup bulk data

```

status      1111 0000(F0H) System exclusive
ID No.     0100 0011(43H) YAMAHA
sub status  0000 nnnn(0nH) n = 0 - 15
format no. 0111 1110(7EH)
byte count 0000 0000(00H)
byte count 0100 1100(4CH)
           0100 1100(4CH) "L"
           0100 1101(4DH) "M"
           0010 0000(20H) Space
           0010 0000(20H) Space
           0011 1000(38H) "8"
           0100 0001(41H) "A"
           0011 1001(39H) "9"
           0011 1001(39H) "9"
data name  0101 0011(53H) "S"
           0010 0000(20H) Space
data      0000 dddd System setup
           memory (66 bytes)
           :
           :
           0000 dddd
check sum 0eee eeee
EOX       1111 0111(F7H) End of exclusive
    
```

#4 Parameter Change data

```

status      1111 0000(F0H) System exclusive
ID No.     0100 0011(43H) YAMAHA
sub status  0001 nnnn(1nH) n = 0 - 15
format no. 0001 1110(1EH)
device code 0000 0110(06H) REV500
parameter no. 0000 pppp *1)
           0000 pppp
data      0000 dddd parameter data (4
           bytes)
           0000 dddd
           0000 dddd
           0000 dddd
EOX       1111 0111(F7H) End of exclusive
    
```

#5 Current buffer bulk data

```

status      1111 0000(F0H) System exclusive
ID No.     0100 0011(43H) YAMAHA
sub status  0000 nnnn(0nH) n = 0 - 15
format no. 0111 1110(7EH)
byte count 0000 0000(00H)
byte count 0100 1000(48H)
           0100 1100(4CH) "L"
           0100 1101(4DH) "M"
           0010 0000(20H) Space
           0010 0000(20H) Space
           0011 1000(38H) "8"
           0100 0001(41H) "A"
           0011 1001(39H) "9"
           0011 1001(39H) "9"
data name  0100 1101(4DH) "M"
program no. 0000 0000(00H)
data      0000 dddd Memory bulk
           (62 bytes)
           :
           :
           0000 dddd
check sum 0eee eeee
EOX       1111 0111(F7H) End of exclusive
    
```

2. Receive data

2-1. Channel information

#1 Program Change

```

status      1100 nnnn(CnH) n = 0 - 15
program no. 0ppp pppp p = 0 - 127
    
```

#2 Control Change

```

status      1011 nnnn(BnH) n = 0 - 15
controller no. 0ccc cccc *2)
control value 0vvv vvvv v = 0 - 127
    
```

2-2. System information

#1 Program bulk dump request

```

status      1111 0000(F0H) System exclusive
ID No.     0100 0011(43H) YAMAHA
sub status  0010 nnnn(2nH) n = 0 - 15
format no. 0111 1110(7EH)
           0100 1100(4CH) "L"
           0100 1101(4DH) "M"
           0010 0000(20H) Space
           0010 0000(20H) Space
           0011 1000(38H) "8"
           0100 0001(41H) "A"
           0011 1001(39H) "9"
           0011 1001(39H) "9"
data name  0100 1101(4DH) "M"
program no. 0mmm mmmm m = 1 - 100
EOX       1111 0111(F7H) End of exclusive
    
```

#2 Program Change Table bulk dump request

status 1111 0000(F0H) System exclusive
 ID No. 0100 0011(43H) YAMAHA
 sub status 0010 nnnn(2nH) n = 0 - 15
 format no. 0111 1110(7EH)
 0100 1100(4CH) "L"
 0100 1101(4DH) "M"
 0010 0000(20H) Space
 0010 0000(20H) Space
 0011 1000(38H) "8"
 0100 0001(41H) "A"
 0011 1001(39H) "9"
 0011 1001(39H) "9"
 data name 0101 0100(54H) "T"
 bank no. 0000 0001(01H)
 EOX 1111 0111(F7H) End of exclusive

#3 System Setup bulk dump request

status 1111 0000(F0H) System exclusive
 ID No. 0100 0011(43H) YAMAHA
 sub status 0010 nnnn(2nH) n = 0 - 15
 format no. 0111 1110(7EH)
 0100 1100(4CH) "L"
 0100 1101(4DH) "M"
 0010 0000(20H) Space
 0010 0000(20H) Space
 0011 1000(38H) "8"
 0100 0001(41H) "A"
 0011 1001(39H) "9"
 0011 1001(39H) "9"
 data name 0101 0011(53H) "S"
 0010 0000(20H) Space
 EOX 1111 0111(F7H) End of exclusive

#4 Parameter Value Request

status 1111 0000(F0H) System exclusive
 ID No. 0100 0011(43H) YAMAHA
 sub status 0011 nnnn(3nH) n = 0 - 15
 format no. 0001 1110(1EH)
 device code 0000 0110(06H) REV500
 parameter no. 0000 pppp *1)
 0000 pppp
 EOX 1111 0111(F7H) End of exclusive

#5 Current buffer bulk dump request

status 1111 0000(F0H) System exclusive
 ID No. 0100 0011(43H) YAMAHA
 sub status 0010 nnnn(2nH) n = 0 - 15
 format no. 0111 1110(7EH)
 0100 1100(4CH) "L"
 0100 1101(4DH) "M"
 0010 0000(20H) Space
 0010 0000(20H) Space
 0011 1000(38H) "8"
 0100 0001(41H) "A"
 0011 1001(39H) "9"
 0011 1001(39H) "9"
 data name 0100 1101(4DH) "M"
 program no. 0000 0000(00H)
 EOX 1111 0111(F7H) End of exclusive

#6 Program bulk dump

The transmitted data is identical to "Program bulk data."

#7 Program Change Table bulk data

The transmitted data is identical to "Program Change Table bulk data."

#8 System Setup bulk data

The transmitted data is identical to "System Setup bulk data."

#9 Parameter Change data

The transmitted data is identical to "Parameter Change data."

*1) Ask Yamaha service representative

*2) Correspondence of controller numbers to parameters

EFFECT	PARAMETER	Ctrl. No.
ALL	PRE DELAY	12
	REV TIME	13
	HI-RATIO	14
	ER LEVEL	15
	EFF LEVEL	16
	LO-RATIO	17
	DIFFUS	18
	HPF	19
	LPF	20
REV	DENSITY	21
	LIVENESS	22
	E/R DLY	23
REV→GATE	GATE LVL	24
	HOLD	25
	DECAY	26
	DETECT	27
REV→RESO	SENS	28
	RESO	29
	DECAY	30
	MIX	31
REV→DFILT	SENS	70
	OFFSET	71
	RESO	72
	DECAY	73
REV+CHO	SPEED	74
	REV→CHO	75
	REV→FLG	76
	REV→SYM	77
REV→TRM	SPEED	78
	DEPTH	79
	PHASE	80
	WAVE	81
	ECHO→REV	82
	CROSS FB	83

* REV→FLG only

Function...		Transmitted	Recognized	Remarks
Basic Channel	Default Changed	x x	1-16, off 1-16, off	Memorized
Mode	Default Messages Altered	x x *****	OMNI off/ OMNI off x x	Memorized
Note Number	: True voice	x *****	x x	
Velocity	Note ON Note OFF	x x	x x	
After Touch	Key's Ch's	x x	x x	
Pitch Bender		x	x	
Control Change	12 -31 70 - 83	x x	o o	*1
Prog Change	: True #	x *****	o	*2
System Exclusive		o	o	Bulk Dump
System Common	: Song Pos : Song Sel : Tune	x x x	x x x	
System Real Time	: Clock : Commands	x x	x x	
Aux Messages	: Local ON/OFF : All Notes OFF : Active Sense : Reset	x x x x	x x x x	
Notes: *1 = Depend on effect type. *2 = For program 1 - 128, REV500 program is selected.				

Additions

Mode 1: OMNI ON, POLY
 Mode 3: OMNI OFF, POLY

Mode 2: OMNI ON, MONO
 Mode 4: OMNI OFF, MONO

o : Yes
 x : No



REVOO

Program Data Sheet

Program Type:

No.	Program Name	Effect Type	PRE DELAY	REV TIME	HI-RATIO	ER LEVEL	EFF LEVEL	LO-RATIO	DIFFUS	HPF	LPF	Internal Parameters peculiar to Effect Type
1												
2												
3												
4												
5												
6												
7												
8												
9												
10												
11												
12												
13												
14												
15												
16												
17												
18												
19												
20												
21												
22												
23												
24												
25												