

• YAMAHA R-2000

Natural Sound Stereo Receiver

"X" Power Amplifier Circuit

Unique Yamaha Station Locked Synthesizer Tuning System

Remarkable Spatial Expander Control

7 FM / 7 AM Station Preset Tuning, Auto Phono

Precise Digital Frequency Readout, Auto DX, FM Muting

Continuously Variable Loudness Control, Signal Quality Indicator



OWNER'S MANUAL

Thank you for purchasing the YAMAHA R-2000 AM / FM stereo receiver.

CONTENTS

CAUTION: READ THIS BEFORE OPERATING YOUR R-2000	1/2
CONNECTION DIAGRAM/REAR PANELS	3/4
CONNECTIONS	5/6
FRONT PANEL PARTS AND FUNCTIONS	7/8/9/10
LISTENING TO A PROGRAM SOURCE	10/11
TROUBLESHOOTING	12
SPECIFICATIONS	13/14
BLOCK DIAGRAM	15

IMPORTANT

Please record the serial number of your unit in the space below.

Model: R-2000

Serial No.:

The serial number is located on the rear of the cabinet. Retain this Owner's Manual in a safe place for future reference.

WARNING

To prevent fire or shock hazard, do not expose this appliance to rain or moisture.

CAUTION (PREPARED IN ACCORDANCE WITH UL REGULATION 1270)

1 Read Instructions—All the safety and operating instructions should be read before the appliance is operated.

2 Retain Instructions—The safety and operating instructions should be retained for future reference.

3 Heed Warnings—All warnings on the appliance and in the operating instructions should be adhered to.

4 Follow Instructions—All operating and other instructions should be followed.

5 Water and Moisture—The appliance should not be used near water—for example, near a bathtub, washbowl, kitchen sink, laundry tub, in a wet basement, or near a swimming pool, etc.

6 Carts and Stands—The appliance should be used only with a cart or stand that is recommended by the manufacturer.

7 Wall or Ceiling Mounting—The appliance should be mounted to a wall or ceiling only as recommended by the manufacturer.

8 Ventilation—The appliance should be situated so that its location or position does not interfere with its proper ventilation. For example, the appliance should not be situated on a bed, sofa, rug, or similar surface that may block the ventilation openings; or, placed in a built-in installation, such as a bookcase or cabinet that may impede the flow of air through the ventilation openings.

9 Heat—The appliance should be situated away from heat sources such as radiators, heat registers, stoves, or other appliances (including other audio components) that produce heat.

10 Power Sources—The appliance should be connected to a power supply only of the type described in the operating instructions or as marked on the appliance.

11 Grounding or Polarization—Precautions should be taken so that the grounding or polarization means of the appliance is not impeded.

12 Power-Cord Protection—Power-supply cords should be routed so that they are not likely to be walked on or pinched by items placed upon or against them, paying particular attention to cords at plug, convenience receptacles, and the point where they exit from the appliance.

13 Cleaning—The appliance should be cleaned only as recommended by the manufacturer.

14 Nonuse Periods—The power cord of the appliance should be unplugged from the outlet when left unused for a long period of time.

15 Object and Liquid Entry—Care should be taken so that objects do not fall into and liquids not spilled into the inside of the appliance.

16 Damage Requiring Service—The appliance should be serviced by qualified service personnel when:
A. The power-supply cord or the plug has been damaged; or
B. Objects have fallen, or liquid has been spilled into the appliance; or
C. The appliance has been exposed to rain; or
D. The appliance does not appear to operate normally or exhibits a marked change in performance; or
E. The appliance has been dropped, or the cabinet damaged.

17 Servicing—The user should not attempt to service the appliance beyond those means described in the operating instructions. All other servicing should be referred to qualified service personnel.

18 Power Lines—An outdoor antenna should be located away from power lines.

19 Outdoor antenna grounding—If an outside antenna is connected to the receiver, be sure the antenna system is grounded so as to provide some protection against voltage surges and built up static charges. Section 810 of the National Electrical Code, ANSI/NFPA No. 70—1978, provides information with respect to proper grounding of the mast and supporting structure, grounding of the lead-in wire to an antenna discharge unit, size of grounding conductors, location of antenna-discharge unit, connection to grounding electrodes, and requirements for the grounding electrode.

R-2000

READ THIS BEFORE OPERATING YOUR R-2000

Example of Antenna Grounding as per National Electrical Code Instructions

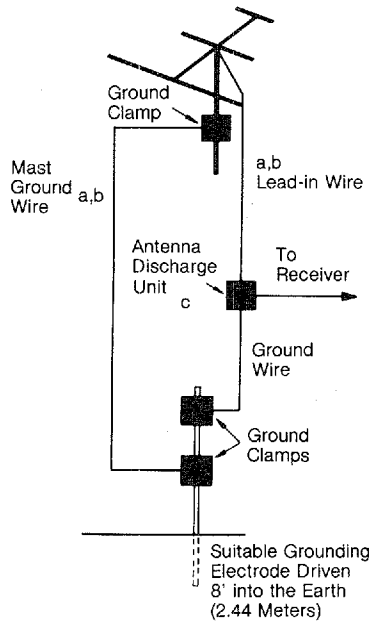

a
Use No. 10 AWG copper or No. 8 AWG aluminum or No. 17 AWG copper-clad steel or bronze wire or larger as ground wires for both mast and lead-in.

b
Secure lead-in wire from antenna to antenna discharge unit and mast ground wire to house with stand-off insulators, spaced from 4 feet (1.22 meters) to 6 feet (1.83 meters) apart.

c
Mount antenna discharge unit as closely as possible to where lead-in enters house.

1 The R-2000 is a sophisticated stereo receiver. To ensure proper operation for the best possible performance, please read this manual carefully.

2 Choose the installation location of your R-2000 carefully. Avoid placing it in direct sunlight or close to a source of heat. Also avoid locations subject to vibration and excessive dust, heat, cold or moisture. Keep it away from such sources of hum as transformers or motors.

3 Do not open the cabinet as this might result in damage to the set or electrical shock. If a foreign object should get into the set, contact your dealer.

4 Do not place records or other objects on top of the receiver so that the ventilation holes are blocked. This will cause the internal temperature to rise and may result in a failure.

5 When removing the power plug from the wall outlet, always pull directly on the plug; never yank the cord.

6 To prevent lightning damage, pull out the power cord and remove the antenna cable in case of an electrical storm.

7 Do not use force when using the switches and knobs.

8 When moving the set be sure to first pull out the power plug and remove cords connecting to other equipment.

9 Always set the volume control to "∞" while lowering the tonearm to play a record, then turn the volume up after the stylus is seated in the record groove.

10 Do not attempt to clean the R-2000 with chemical solvents as this might damage the finish. Use a clean, dry cloth.

11 Be sure to read the "troubleshooting" section for advice on common operating errors before concluding that your R-2000 is faulty.

12 Keep this manual in a safe place for future reference.

13 Do not connect audio equipment to the AC outlets on the rear panel if that equipment requires more power than the outlets are rated to provide.

R-2000

CONNECTION DIAGRAM/REAR PANEL

Be sure to connect the left (L) and right (R) channels consistently from component to component.

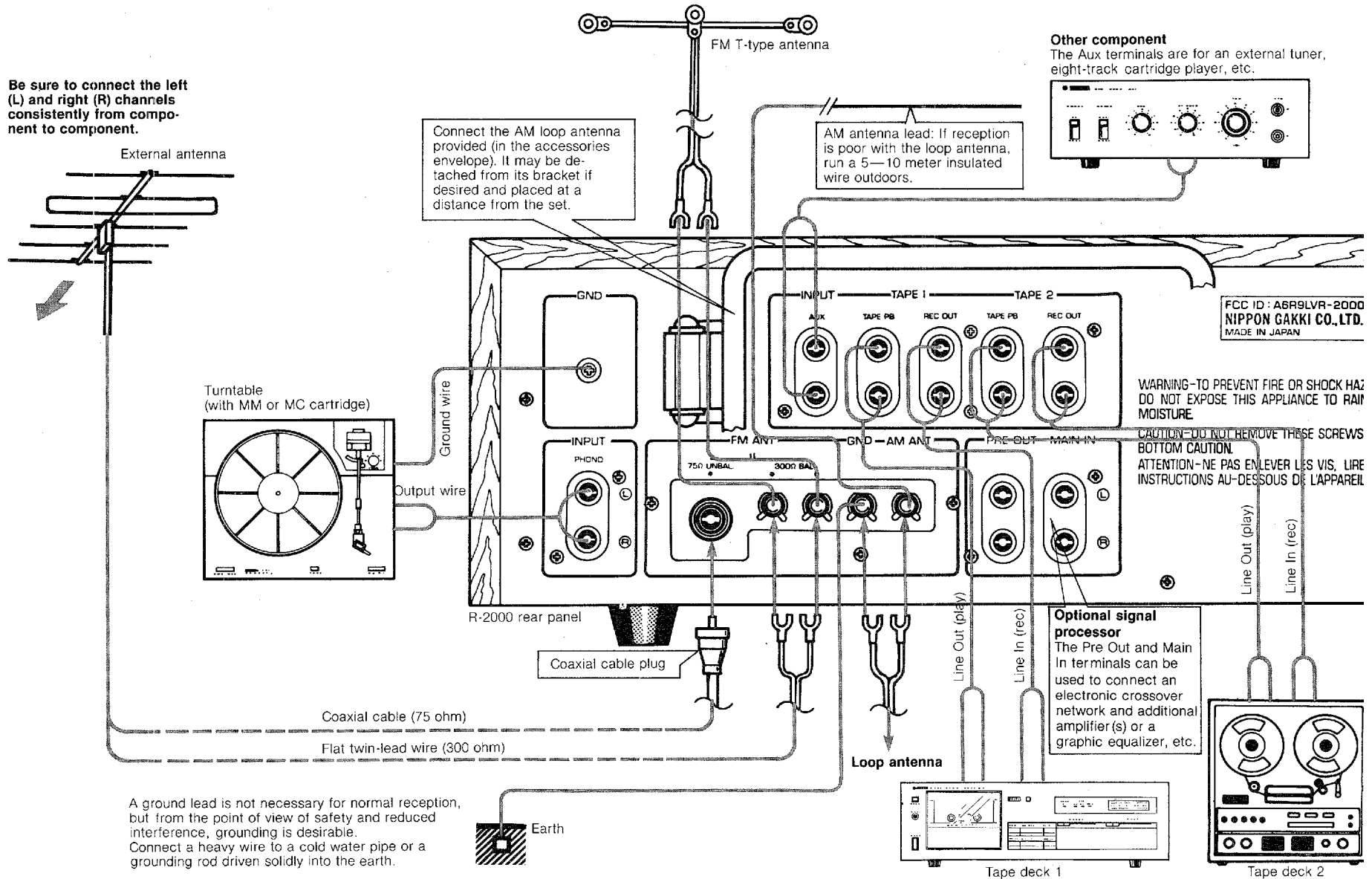

A ground lead is not necessary for normal reception, but from the point of view of safety and reduced interference, grounding is desirable. Connect a heavy wire to a cold water pipe or a grounding rod driven solidly into the earth.

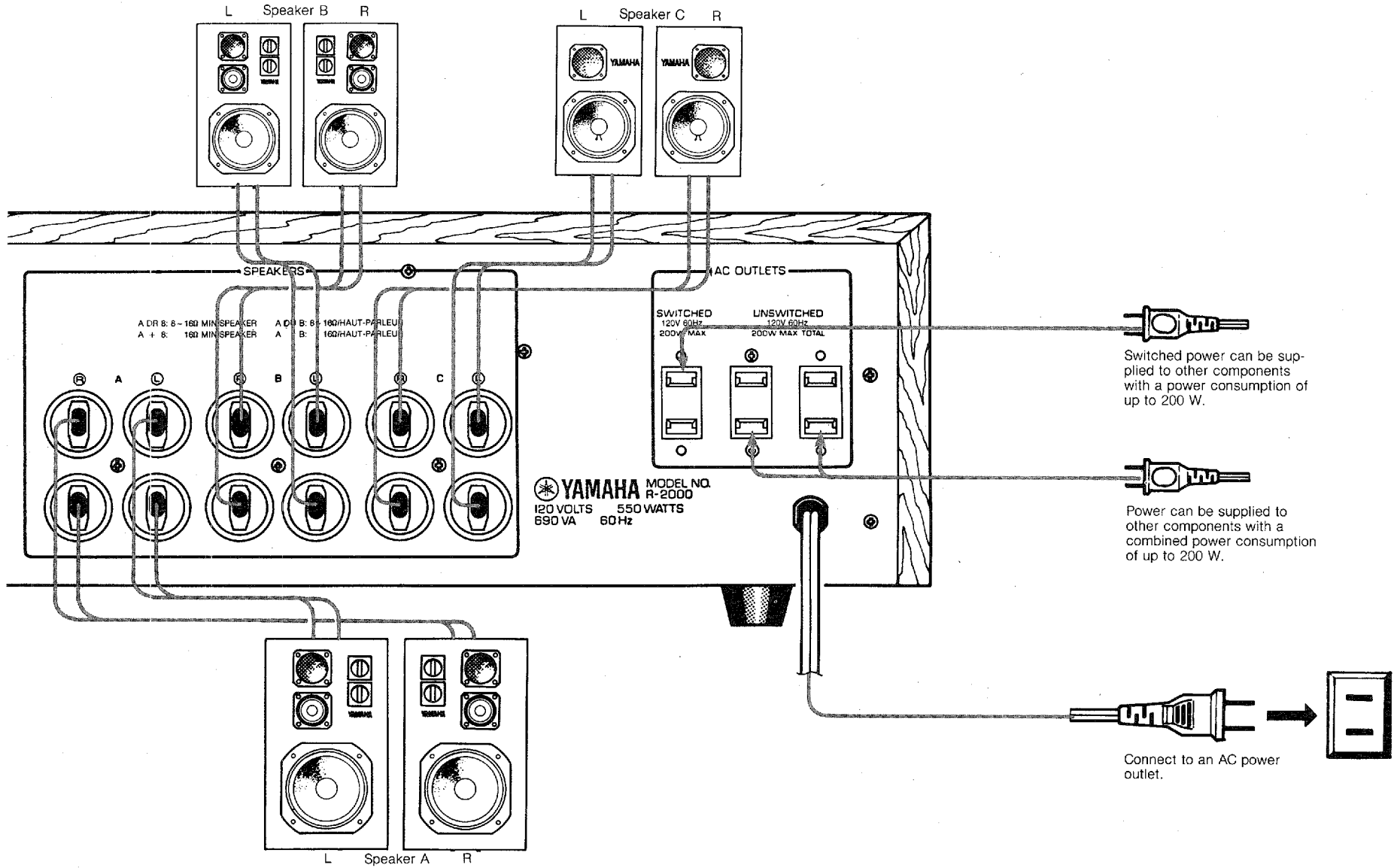

CONNECTING THE SPEAKERS

The matching impedance of this amplifier is 8 ohms. One, two or three pairs of speakers may be connected. If only one pair is connected the recommended speaker impedance may be anywhere between 4 and 16 ohms. If two pairs are connected, however, it is advisable to use speakers with at least an 8 ohm impedance for optimum performance.

Connecting two pairs of 4 ohm speakers is not recommended.

Connect the cords going to the left speakers to the L terminals and the right speaker cords to the R terminals, making sure that the "+" and "-" markings are observed. If the "+" and "-" wires are reversed at either speaker, the sound will be unnatural and will lack bass. Speaker cords should be cut as short as possible; do not coil up excess wire on the floor. Also, do not bundle with cords from other system components.

Turn the speaker terminal to the left, insert the exposed wire of the speaker cord into the hole and then turn to the right. The cord will be locked into position. If these connections are faulty, no sound will be heard from the speakers.

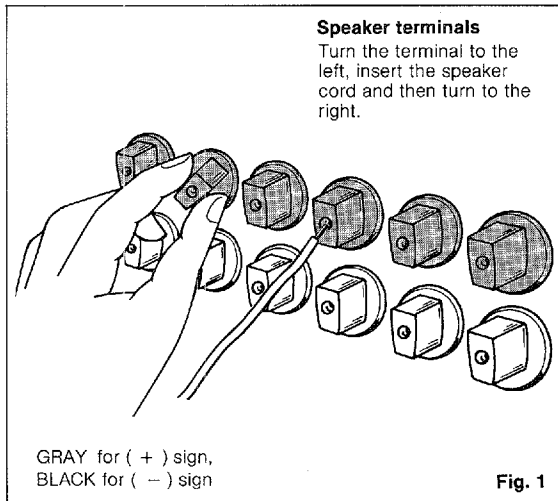

CONNECTING A TURNTABLE

Connect the output cords of the turntable to the receiver's Phono Jacks, and connect the ground wire to the Gnd terminal. Normally, connecting the ground wire produces minimum hum, but in some cases better results are obtained with the ground wire disconnected. The cartridge and the turntable's output cords should be positioned well away from such sources of hum as power cords or power transformers of other system components.

CONNECTING A TAPE DECK

Two tape decks can be connected to this receiver as it has two sets of jacks (Tape 1 and Tape 2). Connect the Tape PB jacks to the tape deck's Line Out jacks, and the Rec Out jacks to the tape deck's Line In jacks.

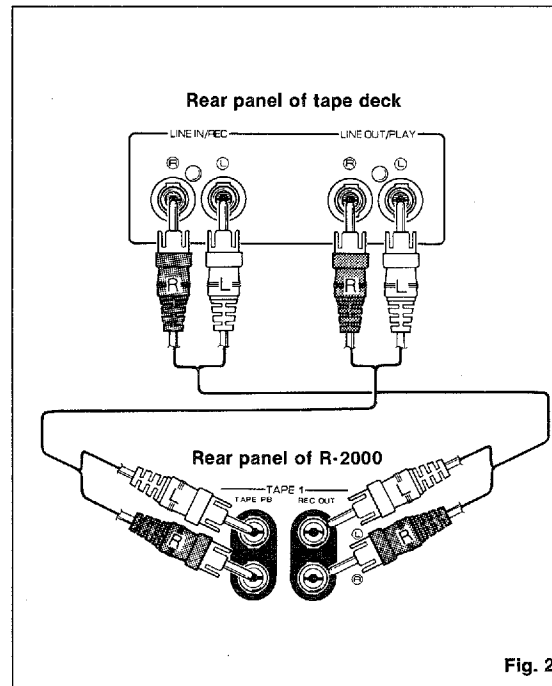

CONNECTING THE AM ANTENNA

In many cases it will be possible to get excellent AM reception with the provided AM loop antenna. Attach the antenna leads to the Gnd and AM Ant terminals and rotate the antenna in its bracket for best reception. The loop antenna may also be removed and hung on the wall. If necessary, an outdoor antenna may be used for improved AM reception. Connect a 5—10 meter length of insulated wire to the AM Ant terminal and run it outdoors.

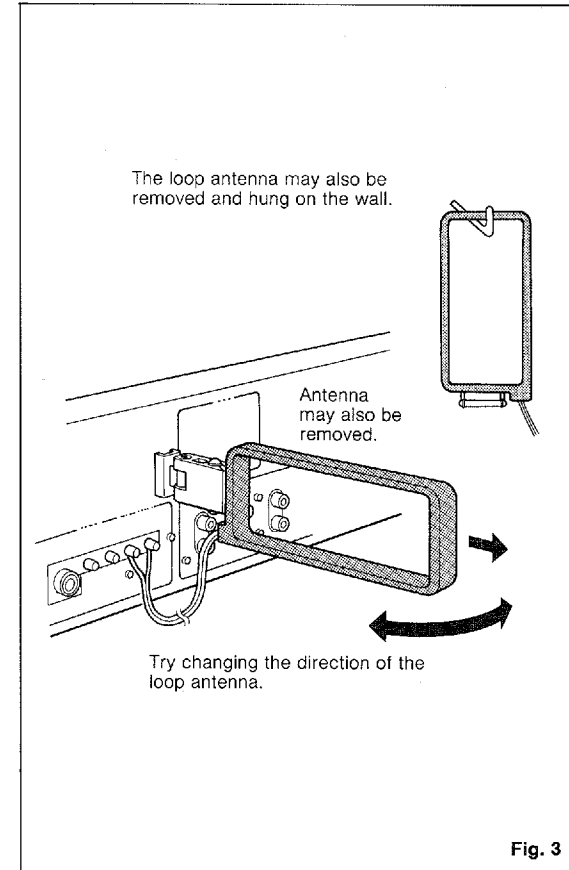

CONNECTING THE FM ANTENNA

Choose an FM antenna that is appropriate to the local reception conditions. Consider the distance from the broadcast station and possible interfering objects such as surrounding tall buildings. In cases where there is a strong signal from a local station, a portable T-type antenna is usually adequate. Connect the feeder wire to the 300 ohm terminal, stretch the wire out tight, and turn to obtain optimum reception. Attach to a suitable support such as a wall.

In all but the best reception conditions, an outdoor FM antenna is necessary for best results. Either 300 ohm flat twin-lead wire or 75 ohm coaxial cable may be used. In locations where electrical interference is a problem, coaxial cable is preferable. Refer to fig. 4 for instructions on installing the coaxial plug.

PRE OUT/MAIN IN TERMINALS

For extra system flexibility, the preamp and main amp sections of the R-2000 are not connected permanently together as with most receivers. With the Pre-Main Coupler switch in the On (■) position, the outputs of the preamp are connected to the inputs of the main amp for normal receiver operation, but in the Off (—) position, the preamp and the main amp are disconnected and operate completely independently. In this case the Pre Out and Main In jacks can be used to access the outputs of the preamp and the inputs of the main amp, respectively. One application for this is to connect a signal processing system such as an equalizer between the preamp and the main amp. Connect the Pre Out terminals to the inputs of the equalizer and the outputs of the equalizer to the main in terminals. With the Pre-Main Coupler switch in the Off position the signal will be equalized before passing to the main amplifier, but in the On position the equalizer will be defeated.

AC OUTLETS

Provided for connecting other audio equipment. The left outlet, with a maximum power capacity of 200 W, is switched on and off by the receiver's power switch; the center and right outlets supply continuous unswitched power up to a combined maximum of 200 W.

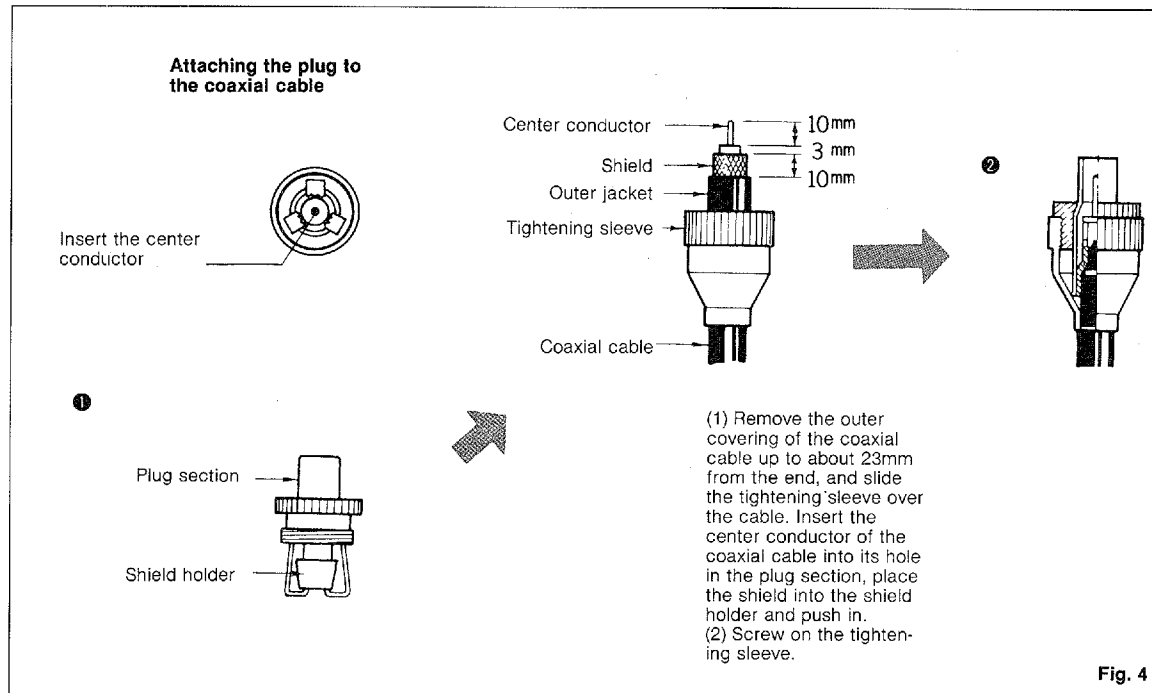

R-2000

FRONT PANEL PARTS AND FUNCTIONS.

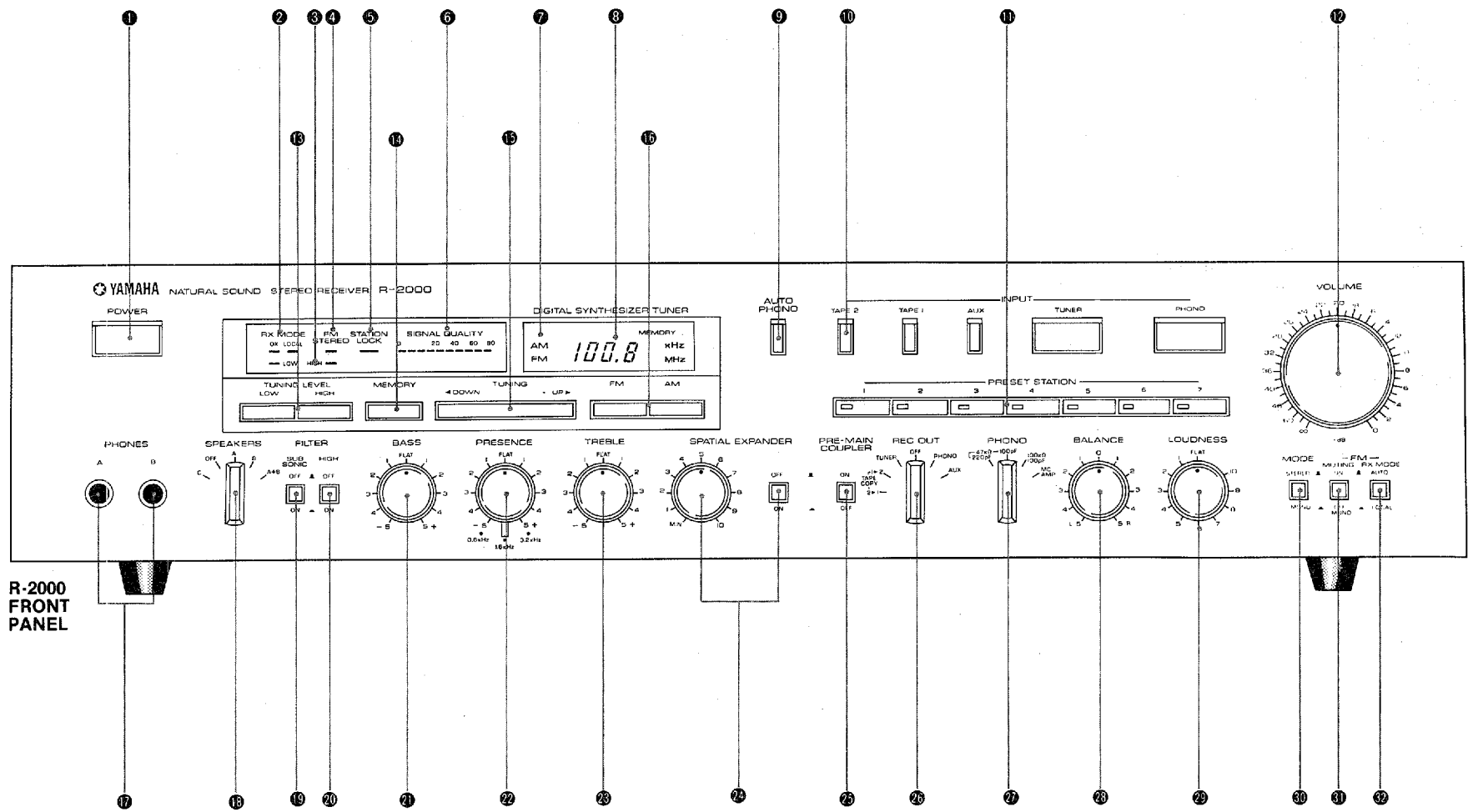

R-2000
FRONT
PANEL

FRONT PANEL PARTS AND FUNCTIONS

① POWER SWITCH

This is a "push-on, push-off" type power switch. When power is turned on the red bar above the switch and the digital frequency display will light.

② RX MODE DX

When the received FM station is weak or being interfered with, this indicator lights to show that the R-2000 is in DX mode.

LOCAL

When the received FM station is sufficiently strong, this indicator lights to denote local mode. Neither of these indicators function when AM is being received.

③ TUNING LEVEL INDICATOR

Indicates High or Low Tuning Level mode. See ⑩.

④ FM STEREO

When an FM stereo broadcast is being received this indicator automatically lights.

⑤ STATION LOCK

This indicator lights to show that the SLL synthesizer circuit has locked accurately onto your station for perfect reception. Audio output is automatically blocked on FM until this indicator comes on.

⑥ SIGNAL QUALITY INDICATOR

This indicator shows the strength of the received station. *In the case of FM reception, a slight flickering indicates the presence of multipath interference. This can be eliminated by using a directional FM antenna and adjusting its height and direction until the display is stable.

⑦ AM/FM INDICATOR

Lights to show AM or FM.

⑧ DIGITAL FREQUENCY READOUT

This displays the frequency of the received station.

⑨ AUTO PHONO SWITCH

Selects Auto Phono mode. In this mode, the R-2000 automatically monitors the turntable input signal and selects the turntable as the input source when a record is put on, overriding the source that was selected with the Input Selector buttons. This means that if you are listening to an FM station, for example, you can play a record without having to touch the receiver at all. The R-2000 will automatically select the turntable and reselect the tuner when the record has finished playing.

* When a low-output phono cartridge is used, playing a low-signal-level portion of a disc recording may under some circumstances cause the Auto Phono circuit to switch from phono input to the alternately selected program source. This condition may be avoided if necessary by manually selecting phono input with the "Phono" Input Selector button.

⑩ INPUT SELECTOR BUTTONS

Selects the program source to be listened to.

⑪ PRESET STATION BUTTONS

7 FM and 7 AM stations can be memorized. When a preset tuning button is pushed, the corresponding station will be immediately tuned in.

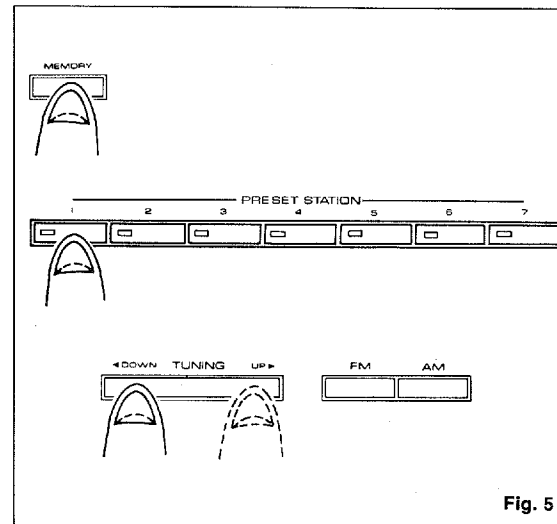

Fig. 5

⑫ VOLUME CONTROL

Used to adjust overall sound volume.

⑬ TUNING LEVEL BUTTONS

Selects High or Low Tuning Level mode. In Low mode, pushing the Tuning button will cause the receiver to scan the band and stop at the next station, regardless of the station's strength. In High mode, the receiver will stop only at strong stations capable of providing quality reception. This makes tuning easier when the band is crowded with stations. Low is automatically selected when power is turned on.

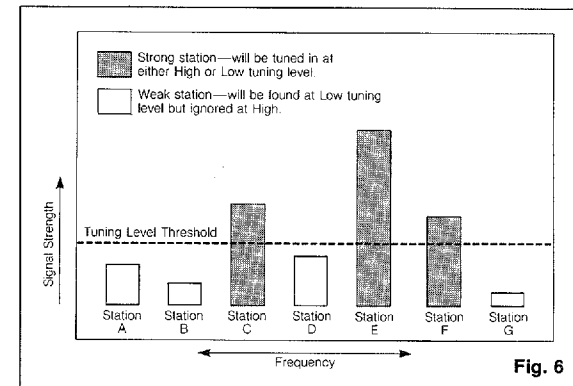

Fig. 6

⑭ MEMORY

This button is used to preset station frequencies into the programmable memory. Please refer to the Preset Tuning section.

⑮ TUNING

This button is used to automatically scan the FM and AM band for stations. Pushing the Up side of the button causes the R-2000 to scan to progressively higher frequencies until a station is found and then to lock the station in. Pushing the Down side of the button causes it to scan in the other direction. If the end of the band is reached without finding a station, the auto-search circuit instantly shifts to the opposite end of the band and the search continues in the same direction.

⑮ BAND SELECT BUTTONS

These switches select either FM or AM broadcasts. The AM/FM Indicator () next to the digital display shows the selected band.

⑯ PHONES JACKS

Used for plugging in headphones. When you want to listen to headphones only, the Speaker switch should both be set to the Off position.

⑰ SPEAKER SWITCH

With this switch, you can select speaker set A, set B, set C, or both sets A and B.

⑱ SUBSONIC FILTER SWITCH

This switch lets you cut out ultra-low-frequency signals without affecting the quality of audible sounds. Caused by turntable rumble or warped records, etc., these subsonic interference signals can sap vital power from the amplifier or even harm speakers if not attenuated.

⑳ HIGH FILTER SWITCH

This switch is used to remove high-frequency tape hiss or record surface noise, etc.

㉑ BASS CONTROL

11-position detent control lets you adjust bass response. Set to the center Flat position for normal response.

㉒ PRESENCE CONTROL

Selectable center frequencies of 0.8 kHz, 1.6 kHz and 3.2 kHz are provided. Variable response at these frequency ranges permits you to suppress an overobtrusive instrument part, for example, or bring out a vocal part.



㉓ TREBLE CONTROL

11-position detent control lets you adjust treble response. Set to the center Flat position for normal response.

㉔ SPATIAL EXPANDER CONTROL

Crossfeeds signals from the left and right channels to produce an expanded "wide stereo" effect. Continuously variable from Min (minimum) to 10 (maximum). A separate defeat switch is provided. Please refer to page 10.

㉕ PRE-MAIN COUPLER

In the On () position, connects the outputs of the preamp to the inputs of the main amp for normal receiver operation. In the Off () position, selects independent preamp and main amp operation to allow a variety of special system setups. Please refer to page 6.

㉖ REC OUT SELECTOR

Used for recording, this switch sends the signal from the selected source to the Rec Out jacks (regardless of the position of the Input Selector switch). Set the input selector to the same source if you wish to monitor the source as you record, or to any other source to listen to that source while recording. If your tape deck has three-head monitoring capability, you can monitor the signal just recorded on the tape by setting the Input Selector switch to Tape. Tapes may be dubbed from deck 1 to deck 2 by setting deck 1 to Play, deck 2 to Record, and the R-2000's Rec Out switch to 1▶2. Dubbing from deck 2 to deck 1 may be accomplished in a similar manner in the 2▶1 position.

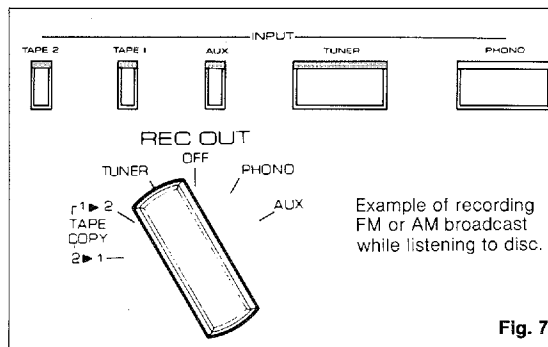

Fig. 7

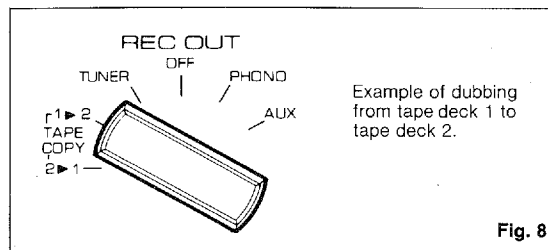

Fig. 8

㉗ PHONO SELECTOR

Should be set to match the type of cartridge used. Either an MM or an MC cartridge can be used, and three load-impedance settings are provided on MM (47 k-ohms/220 pf, 47 k-ohms/100 pf, and 100 k-ohms/100 pf).

㉘ BALANCE CONTROL

This control lets you adjust the relative volume of the left and right speakers, enabling you to compensate for unbalance caused by the installation locations of the speakers and furniture arrangement.

㉙ LOUDNESS CONTROL

Compensates for our ears' reduced sensitivity to the extreme low and high frequencies at low volumes. Set it to the Flat position with the Volume control set to your loudest listening level. Rotate it to the left to reduce the volume while retaining the natural balance of the low and high frequencies.

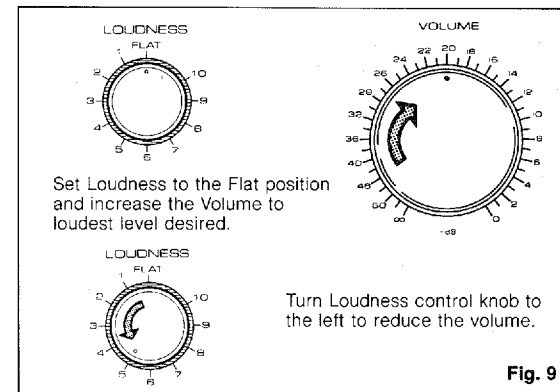

Fig. 9

R-2000

LISTENING TO A PROGRAM SOURCE

⑩ MODE SWITCH

Allows switching between stereo and mono operation. Normally the switch should be set for stereo.

⑪ FM MUTING SWITCH

Turning this switch on (■) activates the muting circuit and silences the noise that would otherwise be heard between FM stations.

When the received station is very weak, it too will be silenced. Therefore, when you want to listen to a very weak station, the switch should be set to the Off/Mono position (—). The receiver automatically forces all stations to be received in mono in the Off/Mono position because the advantage in S/N ratio of mono over stereo allows quieter reception of weak stations.

⑫ RX MODE SWITCH

The RX Mode (reception mode) switch lets you adjust the R-2000's IF stages for best results on either strong or very weak stations.

In the Auto DX position the received signal strength is monitored continuously, and if it falls below a certain level a high-gain, high selectivity circuit is switched in which provides the best possible reception of weak, noisy stations. On stronger signals this circuit is automatically deactivated, for improved distortion and stereo separation.

In the Local position the R-2000 is set up to provide best possible results with strong, local stations. Accurate music reproduction with low distortion and good stereo separation will be achieved.

ALLEN WRENCH

An allen wrench is provided for use in removing or replacing the Rec Out and Phono Selector knobs.

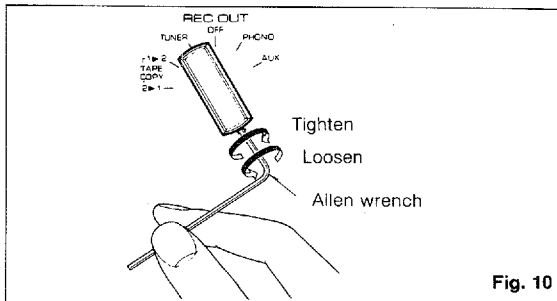

SPATIAL EXPANDER

Yamaha's advanced technology makes listening to a dynamic stereo music program even more exciting. At your command, the stereo sound field is expanded beyond the physical locations of your speakers, filling your room with incredibly realistic sound. Be sure to choose a listening position equidistant from the two speakers to enjoy the optimum expanded stereo effect. The Spatial Expander control is continuously variable from Min (minimum) to 10 (maximum), and it should be set for the most pleasing results depending on the particular program source. The best effect is produced by music sources with excellent separation, and for these high-quality sources a setting of 5~7 is best.

*The signal output at the Rec Out terminals is unaffected by the Spatial Expander.

*No effect is produced with monophonic sources or mono mode.

*There is almost no effect when headphones are used.

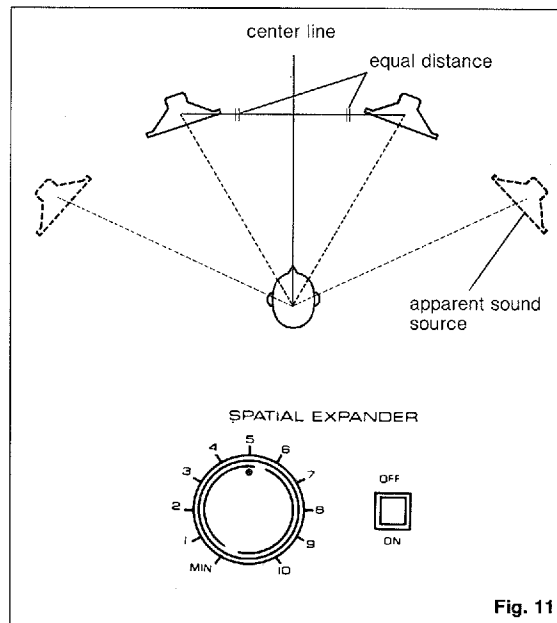

LISTENING TO FM BROADCASTS

1. Press the Tuner button.
2. Press the FM button.
3. Next, set the RX Mode switch to Auto (■), the FM Muting switch to On (■) and the Mode switch to Stereo (■).
4. Press either the Up or the Down side of the Tuning button. The receiver will automatically scan the FM band in the selected direction. When a station is found, the scan will stop and the station will be locked in automatically. Use the Tuning button repeatedly to tune in your desired station.
 - * The Tuning Level buttons may be used if desired to speed up tuning of strong stations by ignoring all weak stations. See Tuning Level Buttons (⑬) in the Front Panel section.
5. When the station has been tuned in, the Station Lock light will come on, indicating that the station has been perfectly locked in. When the station is in stereo the FM Stereo indicator will light, while for mono stations the indicator will remain off.
 - * When listening to a weak, distant station or when there is interference from another station, setting the FM Muting switch to the Off/Mono (—) position will cause the station to be received in mono and considerably reduce noise.
6. Adjust the volume level and listen to the station.

LISTENING TO AM BROADCASTS

1. Press the Tuner button.
 2. Press the AM button.
 3. Press either the Up or the Down side of the Tuning button. The receiver will automatically scan the AM band in the selected direction. When a station is found, the scan will stop and the station will be locked in automatically.
Use the Tuning button repeatedly to tune in your desired station.
- * The Tuning Level buttons may be used if desired to speed up tuning of strong stations by ignoring all weak stations. See Tuning Level Buttons (Ⓢ) in the Front Panel section.
4. When the station has been tuned in, the Station Lock light will come on, indicating that the station has been perfectly locked in.
- * On rather weak AM stations the Station Lock indicator may remain off.
5. Adjust the volume level and listen to the station.

LISTENING TO RECORDS

1. Set the Input selector to Phono.
 2. Set the Phono switch to MM or MC to match your cartridge.
 3. Place a record on the turntable and start it playing.
 4. Adjust the volume level and listen to the record.
- * When lowering the stylus to the record or raising the stylus from the record, turn the volume control all the way to "∞".

RECORDING TAPES

1. Set the Rec Out selector to the source to be recorded.
 2. Start the music from the selected source.
 3. Set the recording level, etc. of the tape deck, and begin recording.
 4. If your tape deck has three heads, setting the R-2000's Input selector to the Tape 1 or Tape 2 position as appropriate will allow you to monitor the recorded material.
 5. While recording the source selected with the Rec Out selector, any other source may be selected with the Input selector and listened to via the speakers.
- * Adjusting the tone controls (Bass, Presence, Treble) or the volume control during recording has no effect on the material being recorded.
- * The Tape Copy 1 ▶ 2 and the Tape Copy 2 ▶ 1 positions of the Rec Out selector are for tape dubbing. Please see Rec Out Selector (Ⓢ) in the Front Panel section.

PLAYING BACK TAPES

1. Set the Input selector to Tape 1 or Tape 2 as appropriate.
2. Set the tape deck to Play.
3. Adjust the volume level and listen to the tape.

PRESET TUNING

In addition to its auto-search tuning feature, the R-2000 has a convenient programmable preset tuning system which allows you to tune in your favorite stations with the touch of a button.

To preset a station into the memory, first tune the station in. Check to see that the Station Lock indicator lights up. While pressing the Memory button, press one of the numbered preset tuning buttons. The tuner will then memorize the station's frequency. Any time the appropriate numbered button is pressed, the station will be automatically tuned in. After you have preset a station, it is a good idea to manually change to another frequency and then push the newly memorized station's button again to see that it is tuned in correctly. Up to 7 AM and 7 FM stations can be preset—a total of 14. In other words, each numbered button selects one of two stations—one FM and one AM—depending on which band has been selected.

To tune in a previously memorized station, first make sure that AM or FM has been selected as appropriate. Then press the numbered button corresponding to the desired station. The station will be automatically tuned in and its frequency will be displayed on the digital readout. The preset tuning button will light to indicate automatic station selection.

There may be cases where static electricity or electrical noise from fluorescent lamps or television sets prevents successful preset tuning. Set the receiver away from such sources of interference. When the button pressed has been preset to a very weak station or there is no broadcast station at the memorized frequency, the frequency may deviate slightly from the memorized frequency.

MEMORY BACKUP POWER SUPPLY

In order to remember the frequencies of preset stations even when the unit is switched off or when the power fails, the receiver contains a rechargeable battery power supply unit.

The battery is automatically charged when the receiver is turned on, and if the receiver is used for a minimum of two hours/week the power unit can supply the memory through power-off periods of about two months. If the unit is not used for an extended period of time, it may be necessary to repeat the preset procedure.



R-2000

TROUBLESHOOTING

Before assuming that your receiver is faulty, check the following troubleshooting list which details the corrective action you can take yourself without having to call a service engineer. If you have any doubts or questions, get in touch with your nearest Yamaha dealer.

	FAULT	CAUSE	CURE
AUDIO	Power is not applied even though the Power switch is turned on.	The power cord is not plugged in.	Plug in the power cord.
	There is no sound with any position of the input selector.	The Speakers switches are not set correctly.	Set them correctly.
		The input cords are not connected securely.	Plug them in securely.
	There is no sound from one speaker.	The speaker connections are not secure.	Secure the connections.
		The Balance control is set all the way to the left or right.	Adjust the balance control correctly.
	There is a lack of bass and no ambience.	The + and - cords have been reversed at the amp or the speakers.	Connect the speaker wires in the correct phase (+ and -).
	There is a humming sound when playing records.	The input cords are not connected securely.	Plug the input cords in securely.
The turntable's ground wire is not connected.		Connect the ground wire.	
There is a howling sound when playing records at high volume.	The turntable and the speakers are too close together or the turntable is not mounted on a firm surface.	Change the location of the turntable or the speakers.	
Unable to record.	The Rec Out selector is set to Off.	Set the Rec Out selector to the source to be recorded.	
FM	Crackling sounds from time to time (especially in weak signal areas).	Ignition noise from vehicles.	The FM antenna should be put up as high as possible, away from the road, and a coaxial cable used.
		Noise from thermostats and other electrical equipment.	Attach a noise suppressor to the equipment causing the noise.
	The FM stereo reception is noisy.	Because of the characteristics of FM stereo broadcasts, this is limited to cases where the transmitter is far away or the antenna input is poor.	Check the antenna connections.
			Try using a multiple element FM antenna.
			Set the FM Muting switch to the Off/Mono position.
	The FM Stereo indicator flickers on and off and reception is noisy.	Insufficient antenna input.	Use an antenna appropriate for the reception conditions in your area.
		Not tuned correctly.	Tune again.
	There is distortion and clear reception cannot be obtained even with a good FM antenna.	There is multipath interference.	Adjust antenna placement to eliminate multipath interference.
	The Signal Quality Indicator lights up but there is no sound.	The muting circuit has turned off the sound because the received station is very weak.	Set the FM Muting switch to the Off/Mono position to disable muting.
No stereo effect even with a stereo broadcast.	The Mode switch is set to Mono or the FM Muting switch is set to Off/Mono.	Set these switches properly.	
A desired station can not be tuned in with Auto Tuning.	The station is too weak.	Use a high-quality directional FM antenna.	
Previously preset stations can no longer be tuned in.	The tuner was unplugged for more than two days.	Repeat the preset procedure.	
AM	Insufficient sensitivity.	Weak signal or loose antenna connections.	Tighten the AM loop antenna connections and rotate it for best reception.
			Use an outdoor antenna.
	There are continuous crackling and hissing noises.	These noises result from lightning, fluorescent lamps, motors, thermostats and other electrical equipment.	Use an outdoor antenna and a ground wire. This will help somewhat but it is difficult to eliminate all noise.
There are buzzing and whining noises.	Another station is interfering with the received station.	This is impossible to remedy.	
	A television set is being used nearby.	Move the television a distance away.	

R-2000

SPECIFICATIONS

AUDIO SECTION	
Minimum RMS Output Power per Channel	
8 ohms, 20 to 20,000 Hz,	
0.015% THD	150 W (21.8 dBW)
8 ohms, 1 kHz,	
0.01% THD	165 W (22.2 dBW)
8 ohms, 20 to 20,000 Hz,	0.005% THD,
Main In	150 W (21.8 dBW)
Dynamic Headroom	
(8 ohms)	3 dB
Total Harmonic Distortion	
(20 to 20,000 Hz)	
Phono MM to Rec Out	
(3 V output)	0.005%
Phono MC to Rec Out	
(3 V output)	0.01%
Aux/Tape to Pre Out	
(2 V output)	0.005%
Aux/Tape to Sp Out	
(8 ohms, 1 W)	0.005%
Main In to Sp Out	
(8 ohms, 1 W)	0.005%
IM Distortion Ratio	
Aux/Tape to Sp Out	
(8 ohms, 75 W)	0.01%
Power Bandwidth	
(8 ohms, 75 W,	
0.02% THD)	5 to 40,000 Hz
Damping Factor	
(8 ohms, 1 kHz)	Better than 60
Frequency Response	
(Aux/Tape to	
Sp Out, 8 ohms)	5 to 50,000 Hz
	-1 dB
(Main In, DC to	
100,000 Hz)	-1 dB
RIAA Deviation	
Phono MM	
(20 to 20,000 Hz)	±0.2 dB
Phono MC	
(30 to 20,000 Hz)	±0.3 dB

Input Sensitivity/Impedance	
Phono MM	2.5 mV/47 k-ohms,
	100 pF or 220 pF
	2.5 mV/100 k-ohms,
	100 pF
Phono MC	100 μ V/100 ohms
Aux/Tape	120 mV/47 k-ohms
Main In	1 V/47 k-ohms
Input Sensitivity (New IHF)	
Phono MM	0.2 mV
Phono MC	8.2 μ V
Aux/Tape	9.8 mV
Maximum Input Level (0.01% THD)	
Phono MM	
(20 to 20,000 Hz)	250 mV
Phono MM (1 kHz)	280 mV
Phono MC (1 kHz)	11 mV
Output Level/Impedance	
Rec Out (Phono)	120 mV/470 ohms
Pre Out	1 V/430 ohms
Headphone Output	780 mW
	(0.015% THD)
Signal-to-Noise Ratio (IHF A Network)	
Phono MM (5 mV,	
Input Shorted)	90 dB
Phono MC (500 μ V,	
Input Shorted)	84 dB
Aux/Tape	
(Input Shorted)	100 dB
Main In	
(Input Shorted)	120 dB
Signal-to-Noise Ratio (New IHF)	
Phono MM	80 dB
Phono MC	77 dB
Aux/Tape	87 dB
Main In	100 dB
Residual Noise	
(IHF A Network)	50 μ V

Channel Separation	
(1 kHz, vol -30 dB, 5.1 k-ohms)	
Aux/Tape to	
Other Channel	-64 dB
Phono MM to	
Other Channel	-64 dB
Tone Control Characteristics	
Bass (boost/cut)	±11 dB at 80 Hz
Treble (boost/cut)	±12 dB at 10 kHz
Center Frequencies	
Bass	80 Hz
Treble	10 kHz
Presence Control Range	
	±8 dB (Center Frequency)
Center Frequency	0.8/1.6/3.2 kHz
Filter Characteristics	
Low (Subsonic)	15 Hz, -12 dB/oct
High	8 kHz, -6 dB/oct
Continuous Loudness Control	
(Level-Related Equalization)	
Max. Attenuation	-20 dB at 1 kHz
Rec. Output Level/Impedance (Fixed)	
FM (100% mod.	
1 kHz)	500 mV/1.8 k-ohms
AM (30% mod.	
1 kHz)	150 mV/1.8 k-ohms
FM SECTION	
Tuning Range	87.6 to 108 MHz
50 dB Quieting Sensitivity	
Mono (DX)	2.8 μ V (14.2 dBf)
Stereo	
(DX, Auto Blend)	25 μ V (33.2 dBf)
Usable Sensitivity	
IHF Mono (1 kHz 100% mod.)	
(300 ohms)	2.0 μ V (11.3 dBf)
(75 ohms)	1.0 μ V (11.3 dBf)
(1 kHz, 30% mod.)	
300 ohms	1.6 μ V (9.3 dBf)
75 ohms	0.8 μ V (9.3 dBf)
Image Response Ratio	
(98 MHz)	70 dB

IF Response Ratio	
(98 MHz)	100 dB
Spurious Response Ratio	
(98 MHz)	100 dB
AM Suppression Ratio	
(IHF)	65 dB
Capture Ratio (IHF)	
	Local 1.2 dB, DX 2.5 dB
Alternate Channel Selectivity	
(IHF)	Local 30 dB, DX 82 dB
Selectivity	
(Two Signals)	DX 68 dB
Signal-to-Noise Ratio	
Mono	85 dB
Stereo	81 dB
Distortion	
Mono 100 Hz	Local 0.06%, DX 0.1%
1 kHz	Local 0.06%, DX 0.3%
6 kHz	Local 0.08%, DX 0.7%
Stereo 100 Hz	Local 0.07%, DX 0.1%
1 kHz	Local 0.07%, DX 0.5%
6 kHz	Local 0.09%, DX 0.8%
Intermodulation Distortion (IHF)	
Mono	Local 0.07%, DX 0.5%
Stereo	Local 0.08%, DX 1.0%
Stereo Separation (Local)	
50 Hz	50 dB
1 kHz	50 dB
10 kHz	45 dB
Frequency Response	
50 Hz to 10 kHz	±0.3 dB
30 Hz to 15 kHz	±0.3/0.5 dB

Subcarrier Product	
Ratio	65 dB
Muting Threshold	
(DX)	2.8 μ V (14.2 dBf)
Auto-DX Threshold	32 μ V (35.3 dBf)
Tuning Level Threshold	56 μ V (40.2 dBf)
AM SECTION	
Tuning Range	525 to 1,605 kHz
Usable Sensitivity	
(Loop Antenna)	200 μ V (46 dB μ m)
Selectivity	30 dB
Signal-to-Noise	
Ratio	50 dB
Image Response	
Ratio	40 dB
Spurious Response	
Ratio	50 dB
Distortion (1 kHz)	0.3%
Tuning Level Threshold	3 mV (70 dB μ m)
GENERAL	
Semiconductors	
U.S., Canada and General	75 Transistors, 33 ICs, 7 FETs, 70 Diodes, 22 LEDs
Northern Europe, British and Australia	78 Transistors, 33 ICs, 7 FETs, 77 Diodes, 22 LEDs
Power Supply	
U.S. and Canada	120 V, 60 Hz
General	110—120 V/ 220—240 V, 50/60 Hz
Northern Europe	220 V, 50 Hz
Britain and Australia	240 V, 50 Hz
Power Consumption	
U.S. and Canada	550 W
Northern Europe, Britain and Australia	920 W
General	330 W

Dimensions	
(W x H x D)	540 x 122 x 385.6 mm (21-1/4" x 4-3/4" x 15-1/4")
Weight	
U.S. and Canada	13.3 kg (29 lbs. 5 oz.)
Northern Europe	13 kg (28 lbs. 10 oz.)
British, Australia and General	13.1 kg (28 lbs. 14 oz.)

Specifications subject to change without notice.

BLOCK DIAGRAM

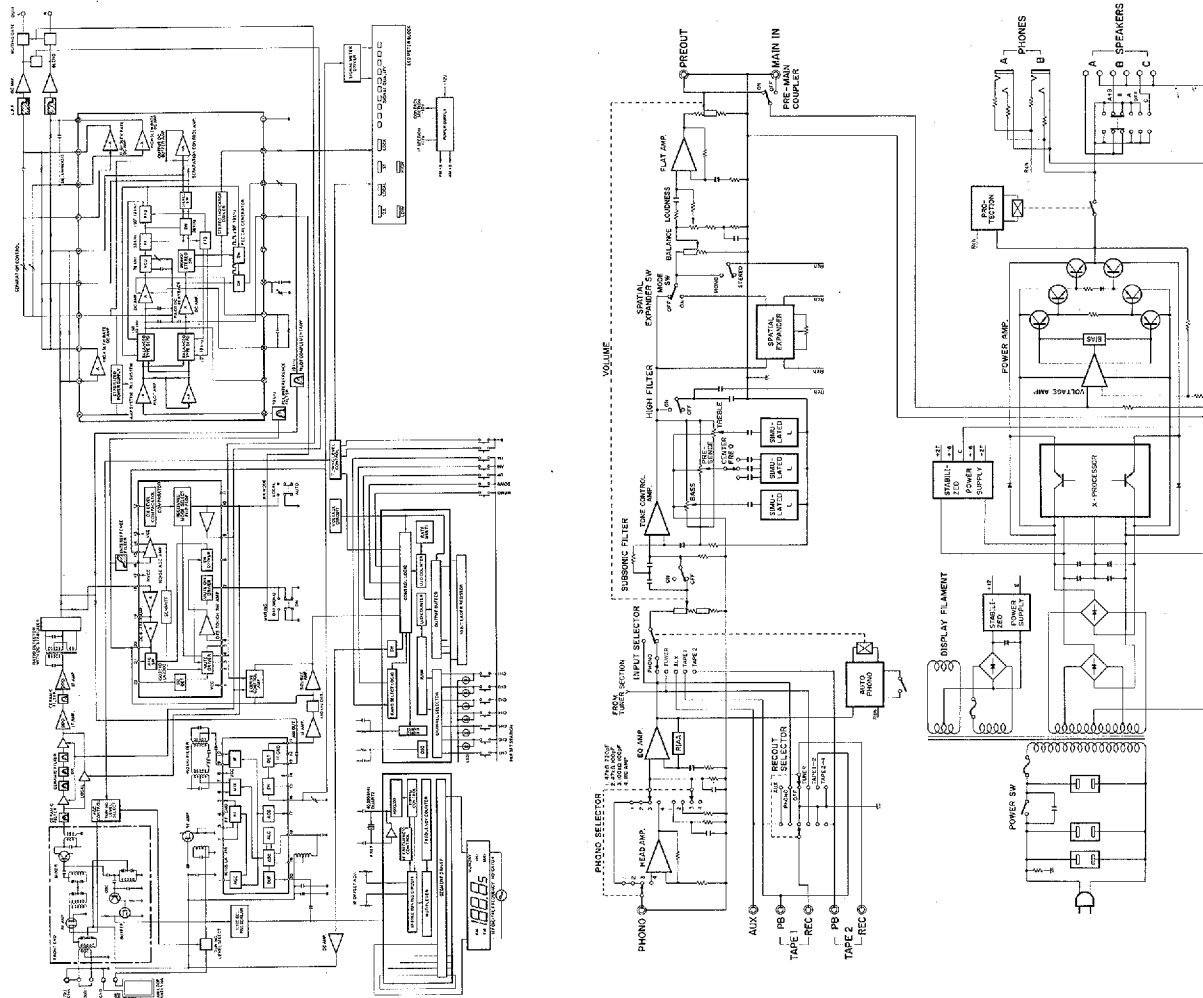

SINCE 1887



YAMAHA

NIPPON GAKKI CO., LTD. HAMAMATSU, JAPAN

Printed in Japan 812