

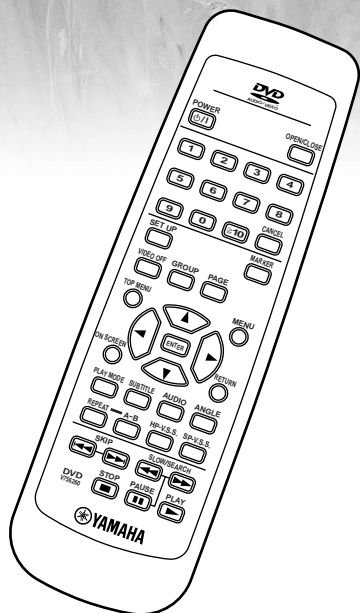

GB

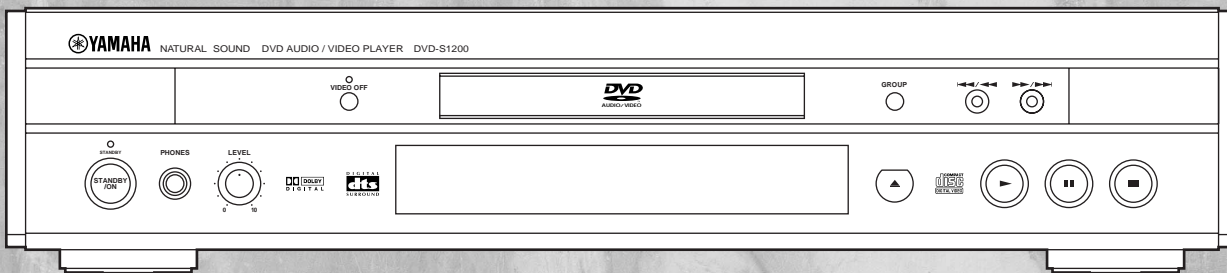

DVD AUDIO/VIDEO PLAYER

DVD-S1200

Owner's manual

Before connecting, operating or adjusting this product, please read these instructions completely.
Please keep this manual for future reference.



Dear customer

Thank you for purchasing this product.
For optimum performance and safety, please read these instructions carefully.

Operations in these instructions are described mainly with the remote control, but you can do the operations on the main unit if the controls are the same.

Accessories

Please check and identify the supplied accessories.

Remote control 1



Batteries 2
for remote control

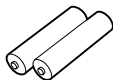

AC mains lead 1

For the United Kingdom

For others

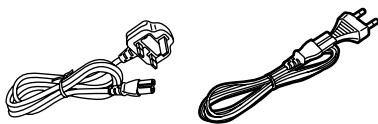

Audio/video cable 1

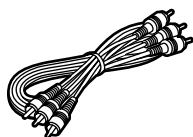

Note

The included AC mains lead is for use with this unit only. Be sure to use the included AC power supply cord with this unit.

CAUTION!

THIS PRODUCT UTILIZES A LASER.
USE OF CONTROLS OR ADJUSTMENTS OR PERFORMANCE OF PROCEDURES OTHER THAN THOSE SPECIFIED HEREIN MAY RESULT IN HAZARDOUS RADIATION EXPOSURE.
DO NOT OPEN COVERS AND DO NOT REPAIR YOURSELF. REFER SERVICING TO QUALIFIED PERSONNEL.

DANGER	- VISIBLE AND INVISIBLE LASER RADIATION WHEN OPEN. AVOID DIRECT EXPOSURE TO BEAM. (FDA 21 CFR)
CAUTION	- VISIBLE AND INVISIBLE LASER RADIATION WHEN OPEN. AVOID EXPOSURE TO BEAM. (IEC60825-1)
ATTENTION	- RAYONNEMENT LASER VISIBLE ET INVISIBLE EN CAS D'OUVERTURE. EXPOSITION DANGEREUSE AU FAISCEAU.
ADVARSEL	- SYNLIG OG USYNLIG LASERSTRÅLING VED ÅBNING. UNDGA UDSÆTTELSE FOR STRÅLING.
VARO!	- AVATTAESSA OLET ALTIINA NÄKYVÄÄ JA NÄKYMÄTÖN LASERSÄTEILYLLÄ. ÄLÄ KATSO SÄTEESEEN.
VARNING	- SYNLIG OCH OSYNLIG LASERSTRÅLNING NÄR DENNA DEL ÄR ÖPPNAD. BETRÄKTA EJ STRÅLEN.
ADVARSEL	- SYNLIG OG USYNLIG LASERSTRÅLING NÄR DEKSEL ÅPNES. UNNGÅ EKSPONERING FOR STRÅLEN.
VORSICHT	- SICHTBARE UND UNSICHTBARE LASERSTRAHLUNG, WENN ABDECKUNG GEÖFFNET. NICHT DEM STRAHL AUSSETZEN.
注意	- 打开时有可见及不可见激光辐射。避免激光束照射。
注意	- ここを開くと可視及び不可視のレーザー光が出ます。ビームを直接見たり、触れたりしないでください。 RQLS0233

(Inside of unit)

CLASS 1 LASER PRODUCT
LASER KLASSE 1 PRODUKT
LUOKAN 1 LASERLAITE
KLASS 1 LASER APPART

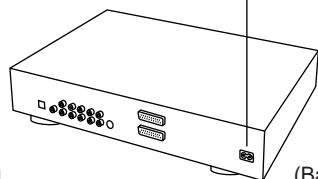

(Back of unit)

Table of contents

Getting started

Accessories	2
Caution for AC Mains Lead	3
Safety precautions	4
The remote control	4
Disc information	5
Connection	6
Connecting an AV amplifier with a built-in decoder	7
Connection to digital audio equipment without a decoder	7
Connecting an AV amplifier with 5.1-channel audio input terminals	8
Analog connection to a 2-channel amplifier or system component	8
Connections using the S video terminal	9
Connecting to a television and a video cassette recorder with 21-pin SCART terminal	9
Recording to MDs or cassette tapes	9
Control reference guide	10

Basic operations

Basic play	11
Resume function	12
Starting play from a selected title or track	12
Skipping chapters or tracks	13
Frame-by-frame viewing	13
Fast forward and rewind-SEARCH	13
Slow-motion play	13
Selecting still pictures-Page Skip	14
Selecting groups to play	14
To enjoy even higher quality sound-VIDEO OFF	14

Advanced operations

Marking places to play again-MARKER	15
Changing soundtracks, subtitle languages and angles	15
Changing the play sequence	16
Program play	16
All group play/Random play	17
Repeat play	18
Repeat play	18
A-B repeat play	18
Increasing your enjoyment of movies and music	19
Enjoying virtual surround effects with 2 speakers or headphones (VIRTUAL SURROUND (V.S.S.))	19
Using headphones	19
Using GUI screens	20
Common procedures	20
Screen for disc information	21
Shuttle screen	21
Screen for unit information	22
Changing settings	23
Common procedures	23
Summary of settings	24
Television settings	26
Speaker setting	27
Digital output	28
Entering a password	28

Reference

Glossary	29
Disc handling	29
Troubleshooting guide	30
Maintenance	31
Specifications	Back cover

(For United Kingdom)

(U.K. model only)

For your safety, please read the following text carefully.

This appliance is supplied with a moulded three pin mains plug for your safety and convenience.

A 5-ampere fuse is fitted in this plug.

Should the fuse need to be replaced please ensure that the replacement fuse has a rating of 5-ampere and that it is approved by ASTA or BSI to BS1362.

Check for the ASTA mark  or the BSI mark  on the body of the fuse.

If the plug contains a removable fuse cover you must ensure that it is refitted when the fuse is replaced.

If you lose the fuse cover the plug must not be used until a replacement cover is obtained.

A replacement fuse cover can be purchased from your local dealer.

CAUTION!

IF THE FITTED MOULDED PLUG IS UNSUITABLE FOR THE SOCKET OUTLET IN YOUR HOME THEN THE FUSE SHOULD BE REMOVED AND THE PLUG CUT OFF AND DISPOSED OF SAFELY.

THERE IS A DANGER OF SEVERE ELECTRICAL SHOCK IF THE CUT OFF PLUG IS INSERTED INTO ANY 13-AMPERE SOCKET.

If a new plug is to be fitted please observe the wiring code as stated below.

If in any doubt please consult a qualified electrician.

IMPORTANT

The wires in this mains lead are coloured in accordance with the following code:

Blue: Neutral, Brown: Live.

As these colours may not correspond with the coloured markings identifying the terminals in your plug, proceed as follows:

The wire which is coloured Blue must be connected to the terminal which is marked with the letter N or coloured Black or Blue.

The wire which is coloured Brown must be connected to the terminal which is marked with the letter L or coloured Brown or Red.

WARNING: DO NOT CONNECT EITHER WIRE TO THE EARTH TERMINAL WHICH IS MARKED WITH THE LETTER E, BY THE EARTH SYMBOL  OR COLOURED GREEN OR GREEN/YELLOW.

THIS PLUG IS NOT WATERPROOF—KEEP DRY.

Before use

Remove the connector cover.

How to replace the fuse

The location of the fuse differ according to the type of AC mains plug (figures A and B). Confirm the AC mains plug fitted and follow the instructions below. Illustrations may differ from actual AC mains plug.

1. Open the fuse cover with a screwdriver.

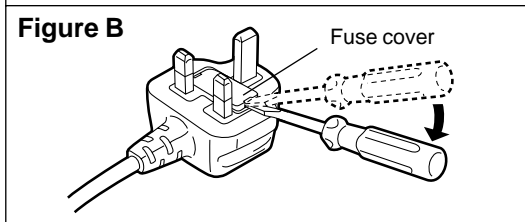
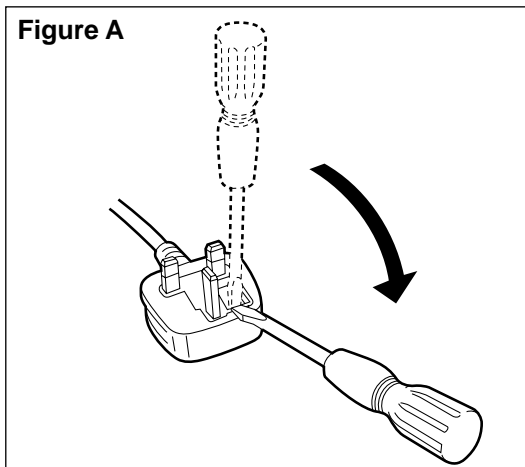

2. Replace the fuse and close or attach the fuse cover.

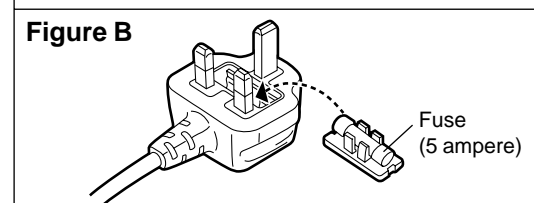
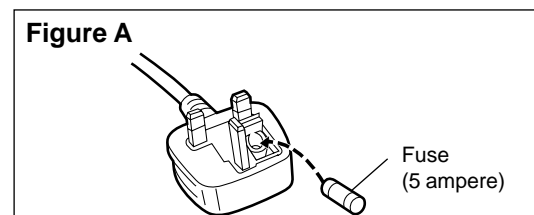

Safety precautions

Placement

Set the unit up on an even surface away from direct sunlight, high temperatures, high humidity, and excessive vibration. These conditions can damage the cabinet and other components, thereby shortening the unit's service life.

Do not place heavy items on the unit.

Voltage

Do not use high voltage power sources. This can overload the unit and cause a fire.

Do not use a DC power source. Check the source carefully when setting the unit up on a ship or other place where DC is used.

AC mains lead protection

Ensure the AC mains lead is connected correctly and not damaged. Poor connection and lead damage can cause fire or electric shock. Do not pull, bend, or place heavy items on the lead.

Grasp the plug firmly when unplugging the lead. Pulling the AC mains lead can cause electric shock.

Do not handle the plug with wet hands. This can cause electric shock.

Foreign matter

Do not let metal objects fall inside the unit. This can cause electric shock or malfunction.

Do not let liquids get into the unit. This can cause electric shock or malfunction. If this occurs, immediately disconnect the unit from the power supply and contact your dealer.

Do not spray insecticides onto or into the unit. They contain flammable gases which can ignite if sprayed into the unit.

Service

Do not attempt to repair this unit by yourself. If sound is interrupted, indicators fail to light, smoke appears, or any other problem that is not covered in these instructions occurs, disconnect the AC mains lead and contact your dealer or an authorized service center. Electric shock or damage to the unit can occur if the unit is repaired, disassembled or reconstructed by unqualified persons.

Extend operating life by disconnecting the unit from the power source if it is not to be used for a long time.

Do not place the unit on amplifiers or equipment that may become hot.

The heat can damage the unit.

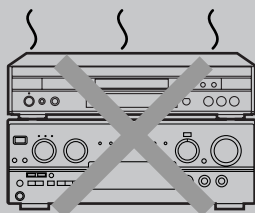

WARNING:

TO REDUCE THE RISK OF FIRE, ELECTRIC SHOCK OR PRODUCT DAMAGE, DO NOT EXPOSE THIS APPLIANCE TO RAIN, SPLASHING, DRIPPING OR MOISTURE.

The remote control

Batteries

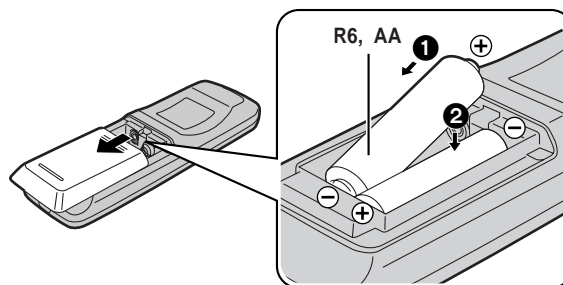

- Insert so the poles (+ and -) match those in the remote control.
- Do not use rechargeable type batteries.

Do not;

- mix old and new batteries.
 - use different types at the same time.
 - heat or expose to flame.
 - take apart or short circuit.
 - attempt to recharge alkaline or manganese batteries.
 - use batteries if the covering has been peeled off.
- Mishandling of batteries can cause electrolyte leakage which can damage items the fluid contacts and may cause a fire. If electrolyte leaks from the batteries, consult your dealer. Wash thoroughly with water if electrolyte comes in contact with any part of your body.

Remove if the remote control is not going to be used for a long period of time. Store in a cool, dark place.

Replace if the unit does not respond to the remote control even when held close to the front panel.

Use

Remote control signal sensor

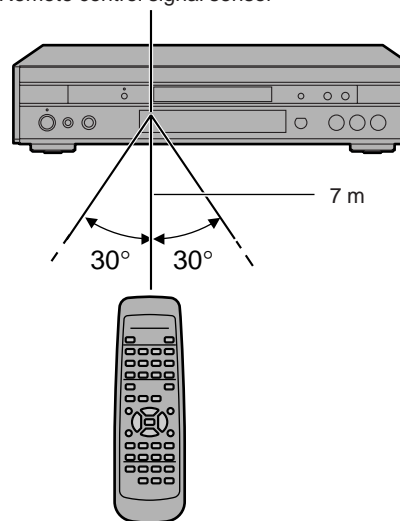

Aim at the sensor, avoiding obstacles, at a maximum range of 7 m directly in front of the unit.

- Keep the transmission window and the unit's sensor free from dust.
- Operation can be affected by strong light sources, such as direct sunlight, and the glass doors on cabinets.

Do not;

- put heavy objects on the remote control.
- take the remote control apart.
- spill liquids onto the remote control.

A



■ Discs that can be played **A**

Disc type	Logo	Region number	Video system	Indication used in instructions
DVD-Audio*	(a)	–	PAL/NTSC	DVD-A
DVD-Video*	(b)	See below	PAL/NTSC	DVD-V
Video CD*	(c)	–	PAL/NTSC	VCD
Audio CD	(d)	–	–	CD

*See the table below for details on how video appears when playing DVD-Video, Video CD and DVD-Audio. You can still enjoy the audio on DVD-Audio irrespective of any differences in video systems.

Some DVD-R and DVD-RW can be played.

■ Region Management Information (DVD-Video only) **B**

Region numbers are allocated to DVD players and software according to where they are sold.

The region number of this unit is “2”.

DVD-Video can be played on this unit if their region number is the same or includes the same number, or if the DVD is marked “ALL”. Confirm the region number for this unit before choosing discs. The number for this unit is indicated on the rear panel of the unit.

■ Discs that cannot be played

DVD-ROM, DVD-R/DVD-RAM, CD-ROM, VSD, CDV, CD-G, +RW, DVD-RW, CVD, SVCD, SACD, Divx Video Discs and Photo CD.

■ DVDs that can be played **C**

This unit has a Dolby Digital decoder and a DTS decoder so you can play DVDs with these marks.

■ Type of disc for the type of connected TV

DVDs and Video CDs are recorded using either PAL or NTSC. Refer to this table when selecting discs.

TV type	Disc	TV Monitor
Multi-system TV	PAL	✓
	NTSC	✓*1
NTSC TV	PAL	×
	NTSC	×
PAL TV	PAL	✓
	NTSC	✓*2

*1 If you select “NTSC” in “NTSC Disc Output” (➡ page 24), the picture may be clearer.

*2 The factory preset for “NTSC Disc Output” is “PAL60”, so no changes to the settings are necessary. (If your television is not equipped to handle PAL 525/60 signals the picture will not be shown correctly.)

Note

When a disc which does not comply with Video CD standard is played, the bottom part of the picture may disappear.

■ Playing DVDs and Video CDs

The producer of the material can control how these discs are played. This means that you may not be able to control play of a disc with some operations described in these operating instructions. Read the disc's instructions carefully.

B

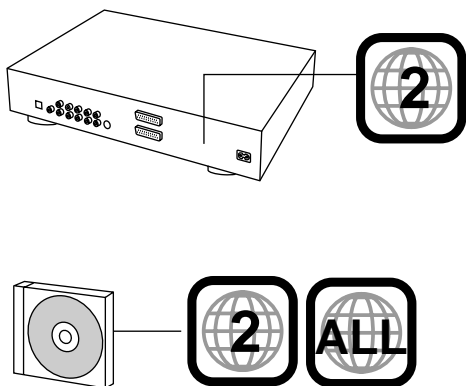

C



As this unit has built-in Dolby Digital and DTS decoders (⇒ page 29), you can enjoy discs recorded with these systems by connecting this unit to the 6-channel input terminals on an AV amplifier (connection **B** below). However, to enjoy the special sound effects available with AV amplifiers that can make you feel like you were in a cinema or hall, connect this unit digitally to the AV amplifier (connection **A** below).

Use analog connection **B to enjoy the high quality audio (sampling frequencies of 192 kHz and 96 kHz) and multi-channel audio found on DVD-Audio. If the disc is copyright-protected, the audio can only be output through the digital output terminal if it is converted to 48 kHz.**

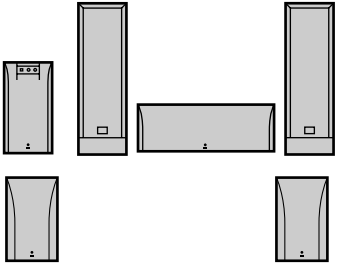
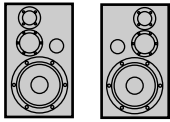
What you want to do	How to do it	Reference page	Settings	Reference page
To enjoy 5.1-channel surround sound 	Digital connection Connect to an amplifier with a built-in decoder or a separate decoder-amplifier combination.	7 A	Digital Audio Output Select "On".	24
	Analog connection Connect to an amplifier with 5.1-channel audio input terminals.	8 B	PCM Down Conversion Dolby Digital DTS Digital Surround MPEG Settings depend on your decoding equipment.	28
To enjoy stereo 	Digital connection Connect to an amplifier with a digital input terminal.	7 C	Digital Audio Output Select "On".	24
	Analog connection Connect to an amplifier or system component with analog input terminals.	8 D	PCM Down Conversion Select "Yes". Dolby Digital/DTS Digital Surround/MPEG Select "PCM".	28

Other uses

Recording to MDs or cassette tapes (⇒ page 9).

Note

- The equipment connections described are examples.
- Peripheral equipment and optional cables sold separately unless otherwise indicated.
- Before connection, turn off all equipment and read the appropriate operating instructions.

Manufactured under license from Dolby Laboratories. "Dolby", "Pro Logic" and the double-D symbol are trademarks of Dolby Laboratories.

Manufactured under license from Digital Theater Systems, Inc. US Pat. No.5,451,942, 5,956,674, 5,974,380, 5,978,762 and other world-wide patents issued and pending. "DTS" and "DTS Digital Surround" are registered trademarks of Digital Theater Systems, Inc. © 1996, 2000 Digital Theater Systems, Inc. All rights reserved.

A Connecting an AV amplifier with a built-in decoder

Before connection

- Do not connect the AC mains lead until all other connections are complete.
- Refer to the amplifier's operating instructions.

Audio/video cable (included)

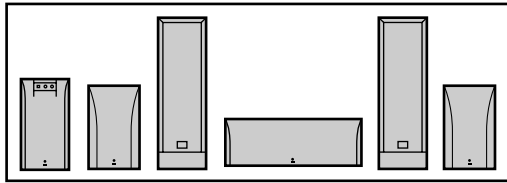
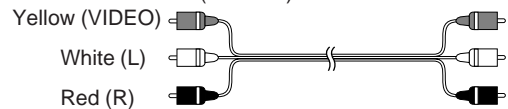

Speakers

- You can enjoy surround sound by connecting from three to six speakers.
Example: Six speakers
- If you do not connect a subwoofer, it is advisable to connect main speakers (L/R) capable of producing bass of less than 100 Hz.

Do not connect the unit's video output through a video cassette recorder

The video from this unit may not be played correctly due to copy-guards if you connect a video cassette recorder between the unit and your television.

Note when connecting the optical digital audio cable

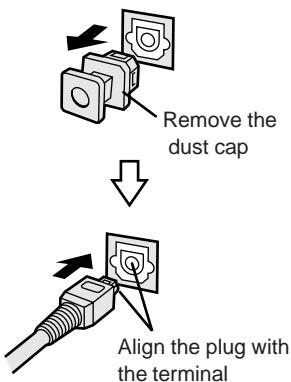

Note

Keep the dust cap and reattach when not using the terminal.

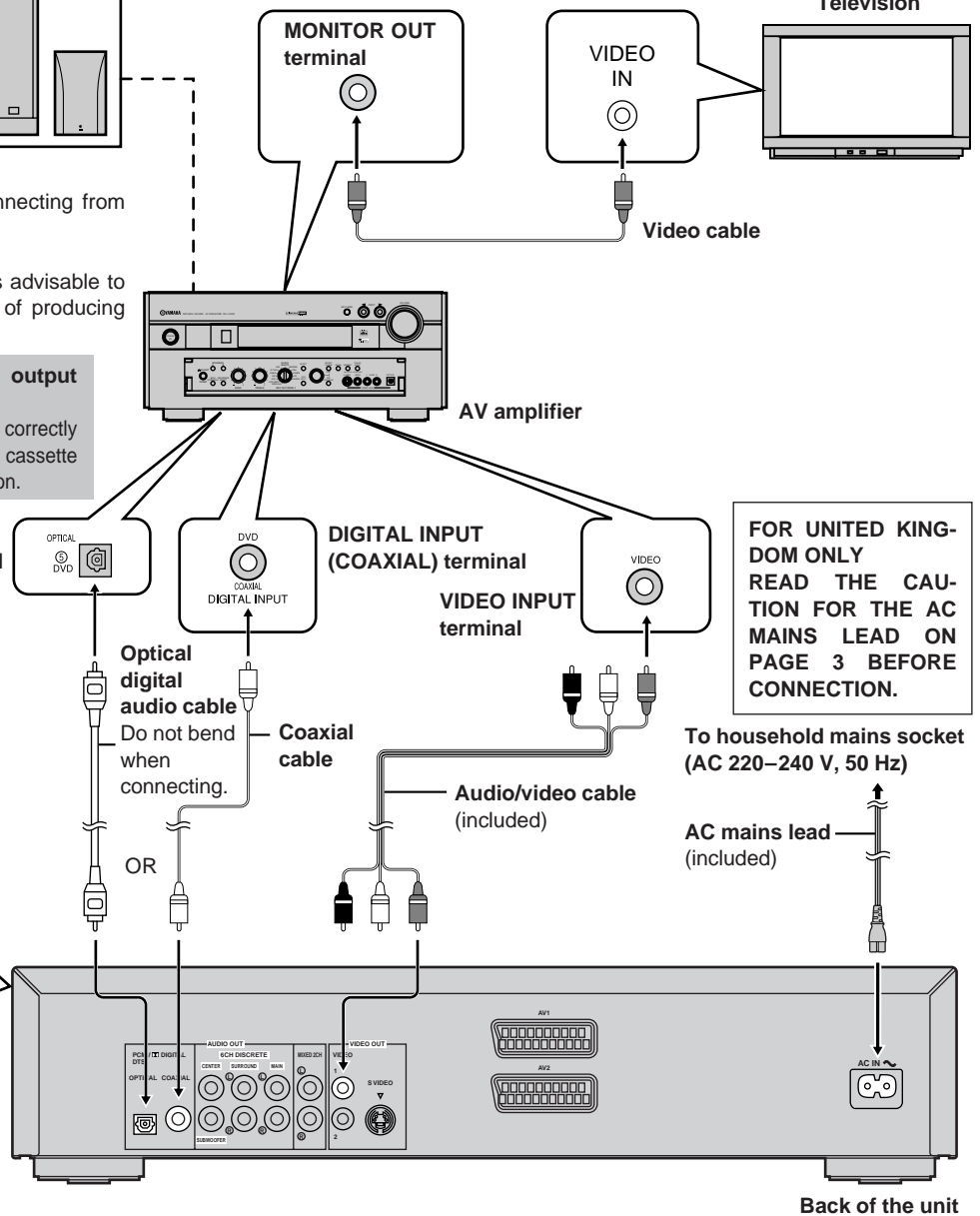

FOR UNITED KINGDOM ONLY
READ THE CAUTION FOR THE AC MAINS LEAD ON PAGE 3 BEFORE CONNECTION.

To household mains socket (AC 220-240 V, 50 Hz)

AC mains lead (included)

Back of the unit

Change PCM Down Conversion, Dolby Digital, DTS Digital Surround, and MPEG to suit the equipment (→ pages 24 and 28).

Note

You cannot use DTS Digital Surround decoders not suited to DVD-Video.

C Connection to digital audio equipment without a decoder

You can still enjoy audio using the connections described above. Make the following settings (→ pages 24 and 28).

Digital Audio Output

Select "On"

PCM Down Conversion

Select "Yes".

Dolby Digital/DTS Digital Surround/MPEG

Select "PCM".

B Connecting an AV amplifier with 5.1-channel audio input terminals

Be sure to switch the amplifier to **ANALOG** input.

- Speaker connections (⇒ page 7)
- Television connections (⇒ pages 7 and 9)

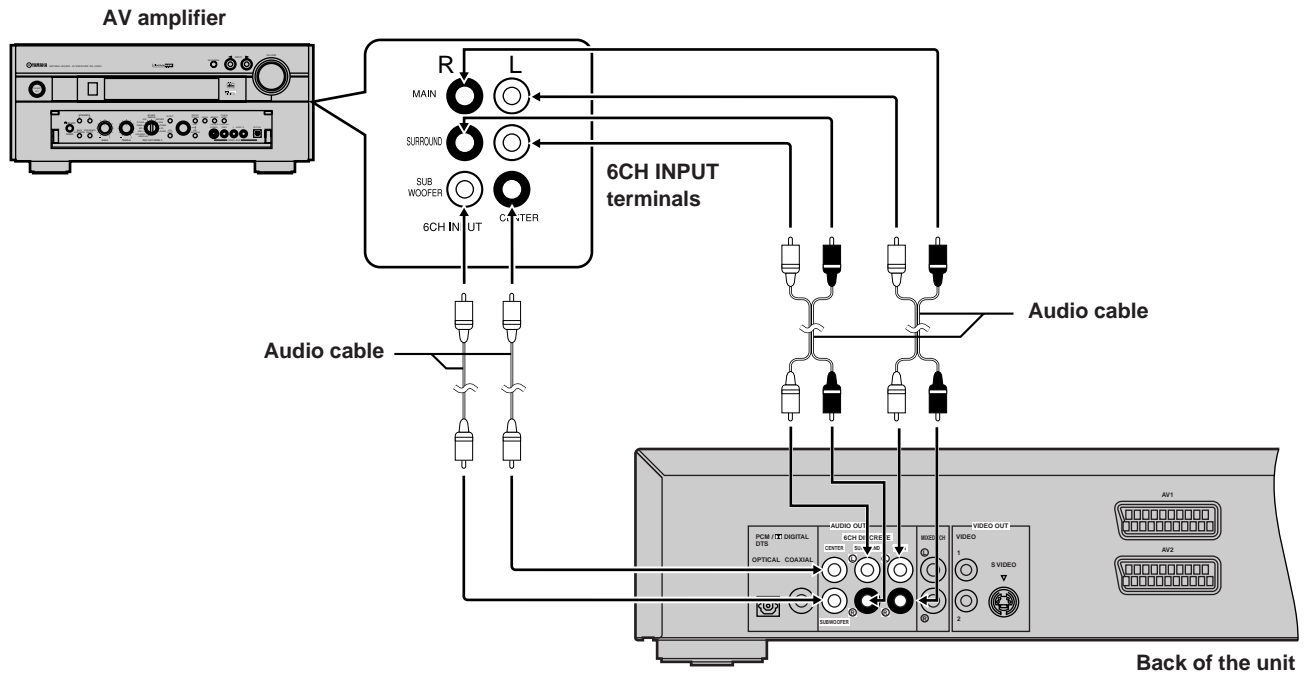

Select “Multi-channel” and adjust the settings to suit the speakers you have connected (⇒ page 27).

Note

Turn Virtual Surround off (⇒ page 19) if you have connected a center speaker, rear speakers or a subwoofer, as well as the main speakers. Sound will not come from the other speakers if Virtual Surround is on.

D Analog connection to a 2-channel amplifier or system component

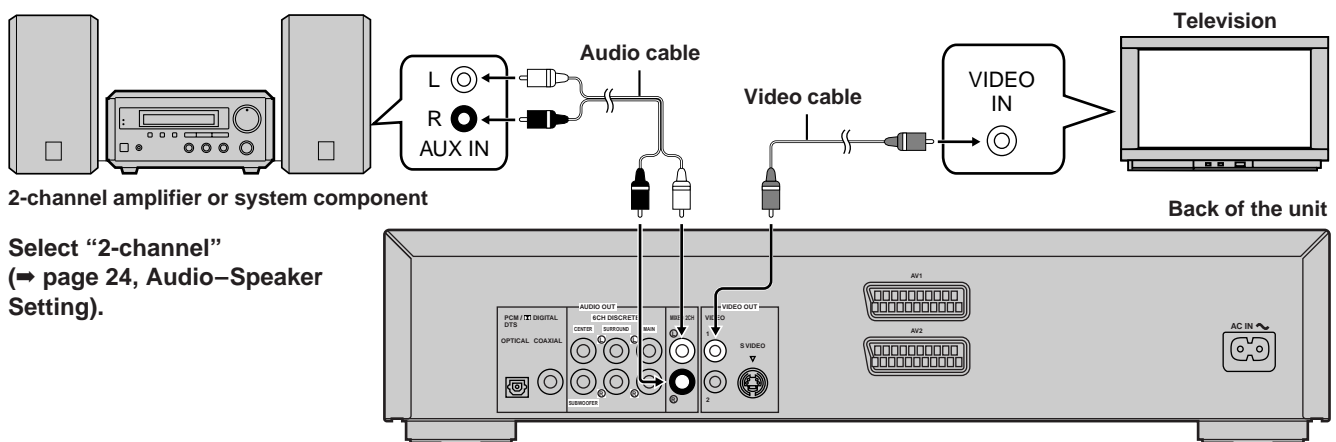

Select “2-channel” (⇒ page 24, Audio-Speaker Setting).

To enjoy Dolby Pro Logic

- If you connect an amplifier that can decode Dolby Pro Logic, you will also need to connect center and rear speakers to enjoy surround sound. Read the instructions for the equipment for connection details.
- Turn Virtual Surround off (⇒ page 19). Dolby Pro Logic will not function correctly if Virtual Surround is on.

Connections using the S video terminal

Audio connections (⇒ pages 7 and 8)

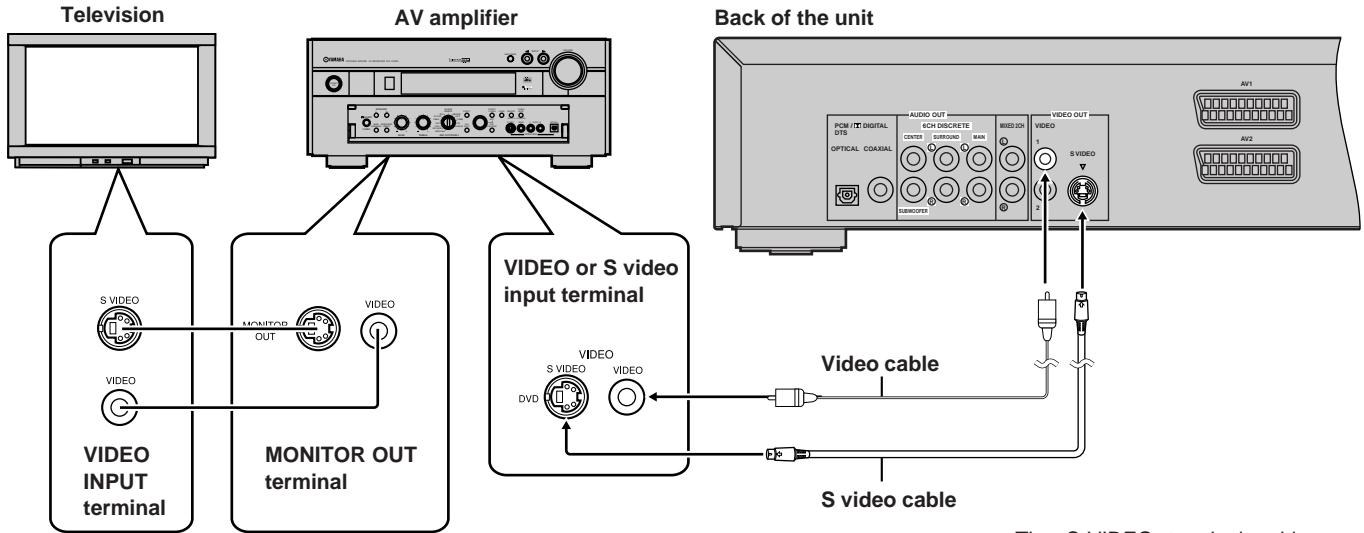

The S-VIDEO terminal achieves a more vivid picture than the VIDEO terminal by separating the chrominance (C) and luminance (Y) signals. (Actual results depend on the television.)

Connecting to a television and a video cassette recorder with a 21-pin SCART terminal

To improve picture quality, you can change the video signal output from the AV1 terminal from "Video" to either "S-Video" or "RGB" to suit the type of television you are using (⇒ page 24, Video—AV 1 Output).

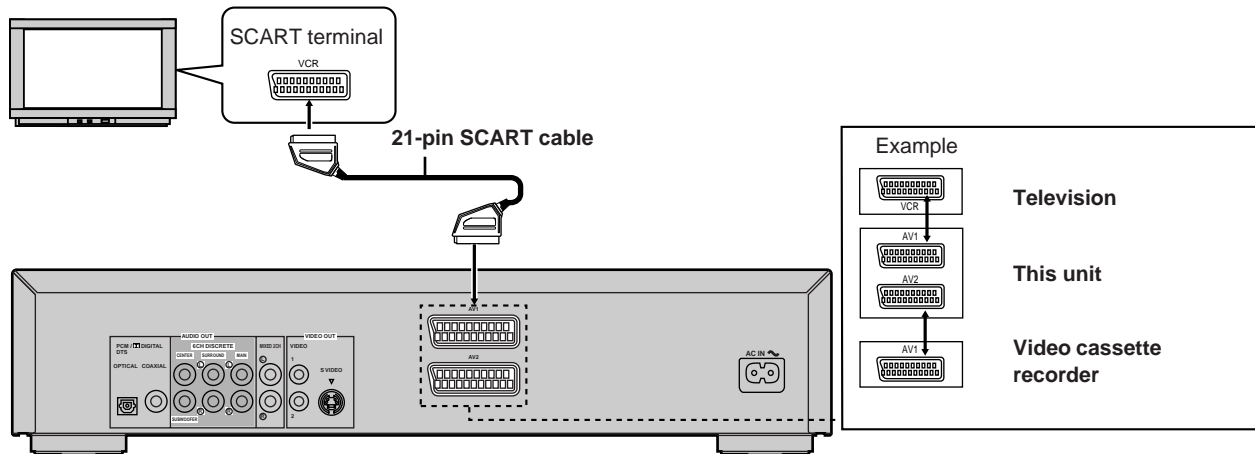

Recording to MDs or cassette tapes

■ Analog recording

You can record to an MD or cassette deck. Using analog connection means sound will be unaffected by the copy guards found on DVDs.

To make an analog recording

Connect the recording equipment with an audio cable (⇒ **D** page 8).

■ Digital recording

You can record the digital signal directly onto an MD. The signals on DVDs will be converted to 48 kHz/16 bit linear PCM. Ensure the following conditions are met.

- There is no copy guard recorded on the disc.
- The recording equipment can handle a sampling frequency of 48 kHz/16 bit.

To make a digital recording

1. Connect the recording equipment with an optical or coaxial digital audio cable (⇒ **A** page 7).
2. When recording DVDs, change the digital audio output settings (⇒ page 24 and 28).
 - PCM Down Conversion: Yes
 - Dolby Digital/DTS Digital Surround: PCM
 - MPEG: PCM
 - Digital Audio Output: On (⇒ page 24)
 - VIRTUAL SURROUND (V.S.S.): OFF (⇒ page 19)

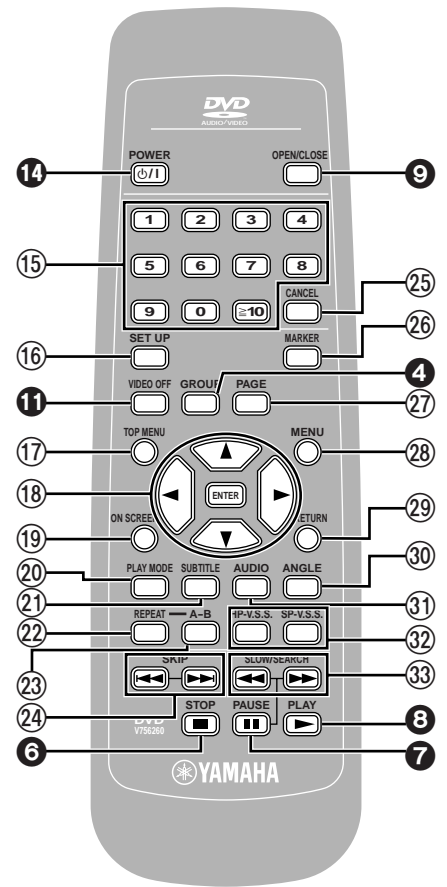
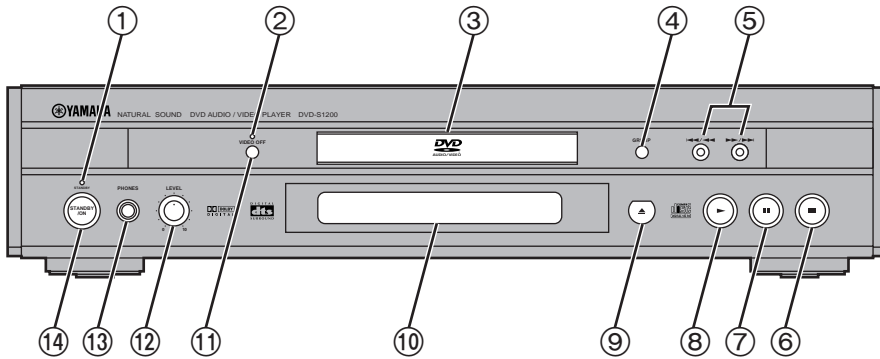

Main unit

Page

①	Standby indicator (STANDBY)	
	When the unit is connected to the AC mains supply, this indicator lights up in standby mode and goes out when the unit is turned on.	
②	VIDEO OFF indicator	14
③	Disc tray	11
④	GROUP button (GROUP)	14
⑤	Skip/Search buttons (◀◀/◀◀, ▶▶/▶▶)	13
⑥	Stop button (■)	11
⑦	Pause button (⏸)	11
⑧	Play button (▶)	11
⑨	Disc tray open/close button (▲)	11
⑩	Display	
⑪	VIDEO OFF button (VIDEO OFF)	14
⑫	Headphone level control (LEVEL)	19
⑬	Headphone jack (PHONES)	19
⑭	Standby/on switch (STANDBY/ON)	11
	Press to switch the unit from on to standby mode or vice versa. In standby mode, the unit is still consuming a small amount of power.	

Remote control

Buttons such as ④ function the same as the controls on the unit.

Page

⑮	Numeric buttons (1–9, 0, ≧10)	11
⑯	Setup button (SET UP)	23
⑰	Top menu button (TOP MENU)	11
⑱	Cursor buttons (▲, ▼, ◀, ▶)/Enter button (ENTER)	11
⑲	ON SCREEN button (ON SCREEN)	20
⑳	Play mode button (PLAY MODE)	16
㉑	Subtitle button (SUBTITLE)	15
㉒	Repeat mode button (REPEAT)	18
㉓	A-B repeat button (A-B)	18
㉔	Skip buttons (◀◀, ▶▶) SKIP	13
㉕	Cancel button (CANCEL)	14
㉖	Marker button (MARKER)	15
㉗	Page button (PAGE)	14
㉘	Menu button (MENU)	11
㉙	Return button (RETURN)	11
㉚	Angle button (ANGLE)	15
㉛	Audio button (AUDIO)	15
㉜	Headphone and Speaker V.S.S. buttons (HP-V.S.S./SP-V.S.S.)	19
㉝	Slow/Search buttons (◀◀, ▶▶ SLOW/SEARCH)	13

Basic play

DVD-A DVD-V VCD CD

Preparation

Turn on the television and select the appropriate video input on the television to suit the connections for the player.

- 1 Press [POWER] to turn on the unit.
- 2 Press [OPEN/CLOSE] to open the disc tray.
- 3 Place the disc on the disc tray.
- 4 Press [▶] (PLAY).
The disc tray closes and play begins.

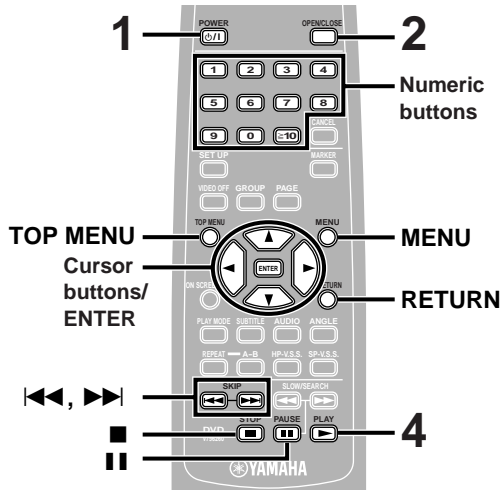
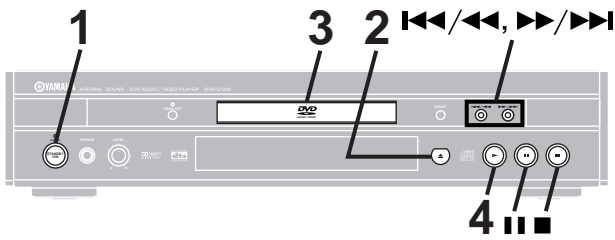

To stop play

Press [■] (→ page 12, Resume function).

To pause play **A**

Press [⏸] during play.

Press [▶] (PLAY) to restart play.

Playing CD-R and CD-RW

This unit can play CD-DA (digital audio) and video CD format audio CD-R and CD-RW that have been finalized* upon completion of recording.

It may not be able to play some CD-R or CD-RW due to the condition of the recording.

* Finalizing is a process that enables CD-R/CD-RW players to play audio CD-R and CD-RW.

Note

If "⊘" appears on the television

- The operation is prohibited by the unit or disc.
- The disc continues to rotate while the menu is displayed even after you finish playing an item. Press [■] when you finish to preserve the unit's motor and your television screen.
- Volume may be lower when playing DVDs than when playing other discs or during television broadcasts.
If you turn the volume up on the television or amplifier, ensure you reduce the volume again before playing other sources so that a sudden increase in output does not occur.

Auto standby

The unit switches to the standby mode after about 30 minutes in the stop mode.

When a menu screen appears on the television

DVD-A DVD-V VCD

Remote control only

Press the numeric buttons to select an item.

To select a 2-digit number

Example: To select item 23, press [≥10], then [2] and [3].

- When playing DVDs, you can also use the cursor buttons [▲, ▼, ◀, ▶] to select items. Press [ENTER] to confirm your selection. Play of the selected item now begins.

Other buttons used to operate menus

Read the disc's instructions for further details about operation.

[▶▶] or [▶▶▶]: Shows the next menu.

[◀◀] or [◀◀◀]: Shows the previous menu.

[RETURN]: Shows the menu screen. **VCD**

[TOP MENU]: Shows the first menu screen. **DVD-A DVD-V**

[MENU]: Shows the menu screen. **DVD-V**

B DVD menus

DVD-Video can have several menus. The menu displayed when you press [TOP MENU] may be different from the menu displayed when you press [MENU].

1 POWER



2 OPEN/CLOSE

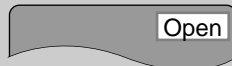
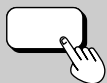

- 3 Label must face upward (With double-sided discs, load so the label for the side you want to play is facing up.)

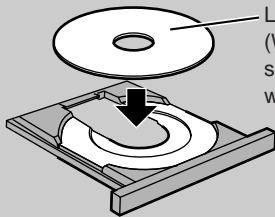

4 PLAY



Unit's display (e.g. DVD-Video is loaded)

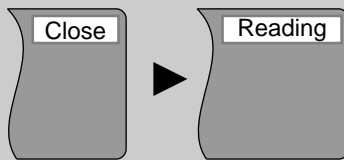

A PAUSE

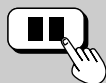

B

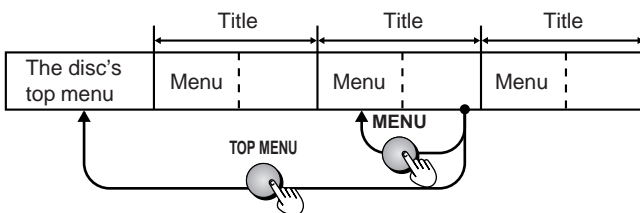

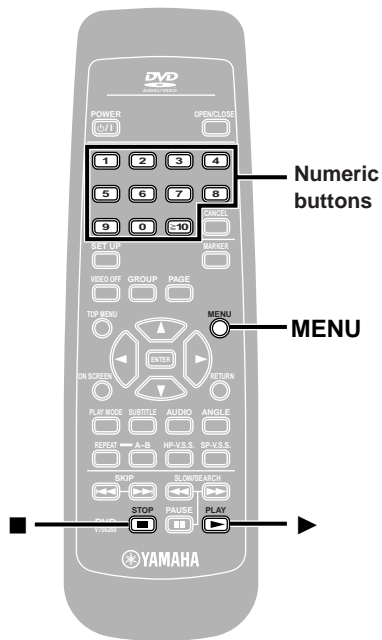

Basic play

DVD-A DVD-V VCD CD

A Resume function

The position you stopped play at is recorded by the unit when "▷" is flashing on the unit's display.

While "▷" is flashing on the unit's display, press [▶] (PLAY) to start play from where you stopped it.

If you are playing DVD-Video, the illustrated message also appears. Press [▶] (PLAY) while the message is displayed and the beginning portions of each chapter up to the current one are played. Full play resumes from the point where you stopped play. (This feature works only within a title.)

If you do not press [▶] (PLAY), the message disappears and play starts from where you stopped it.

To cancel

Press [■] until "▷" disappears from the unit's display.

Note

- The resume function does not work if the disc's play time is not displayed.
- The position is cleared when the disc tray is opened.

B Starting play from a selected title or track

Remote control only

While stopped

Press the numeric buttons.

To select a 2-digit number

Example: To select track 23, press [≥10], then [2] and [3].

Play starts from the selected title/track.

Note

- This may not work with some discs.
- When playing DVD-Audio and you want to start play from a track in a different group, select the group first (⇒ page 14).

For your reference

The numeric buttons also work during play if the disc is a DVD-Audio, Karaoke DVD, Video CD, or CD.

If the Video CD has playback control (⇒ page 29)

Cancel menu play first.

1. Press [■] during play until "PBC Play" is cleared from the unit's display.
2. Press the numeric buttons to select a track to start play. To return to menu play, press [■] and press [MENU].

A



Press PLAY to Chapter Review

B

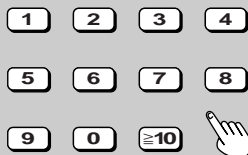

e.g. Video CD

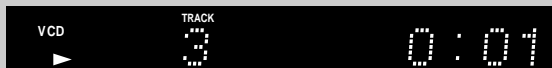

Basic play

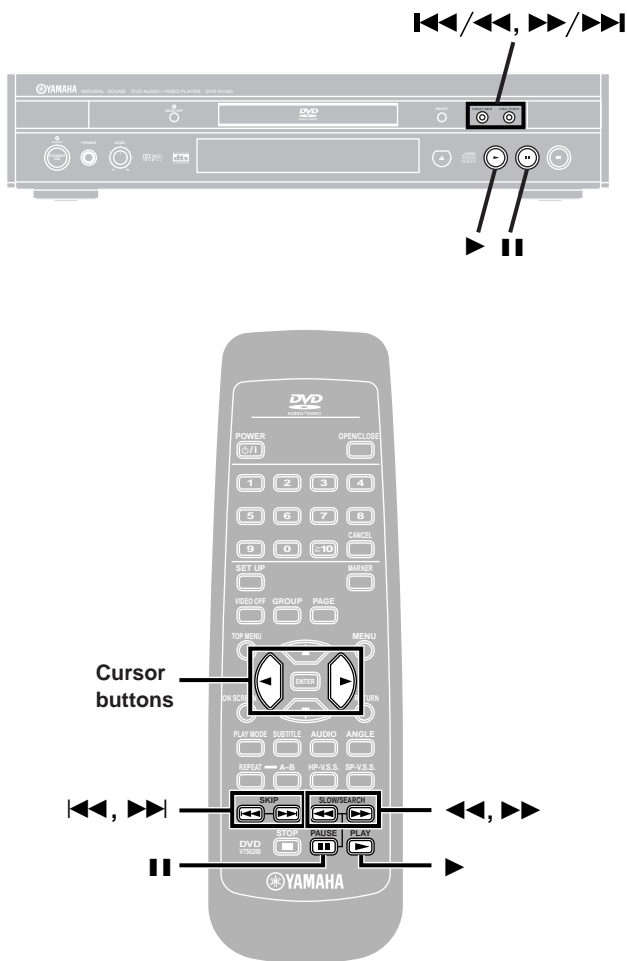

A Skipping chapters or tracks

DVD-A DVD-V VCD CD

During play or while paused

Press [**⏮**] or [**⏭**].

Press [**⏮/⏮**] or [**⏭/⏭**] on the main unit.

Each press increases the number of skips.

B Frame-by-frame viewing

DVD-A DVD-V VCD

Remote control only

While paused

Press the cursor buttons [**⏪**] or [**⏩**].

The frame changes each time the cursor buttons are pressed.

- The frames change in succession if you press and hold [**⏪**] or [**⏩**].
- Pressing [**⏮**] also activates forward frame-by-frame.

C Fast forward and rewind—SEARCH

DVD-A DVD-V VCD CD

During play

Press [**⏮**] or [**⏭**].

Press and hold [**⏮/⏮**] or [**⏭/⏭**] on the main unit.

For your reference

Audio will be heard during search for most discs. You can turn this audio off for some kinds of discs if you want to (➔ page 24, Audio—Audio during Search).

D Slow-motion play

DVD-A DVD-V VCD

While paused

Press [**⏮**] or [**⏭**].

Press and hold [**⏮/⏮**] or [**⏭/⏭**] on the main unit.

Notes

- The speed of search and slow-motion increases up to 5 steps.
- Press [**▶**] (PLAY) to restart play.
- You cannot move backwards with Video CD during frame-by-frame and slow-motion.
- Frame-by-frame and slow motion only work on the moving picture parts of DVD-Audio.
- [**⏮/⏮**], [**⏪**] or [**⏩**]: Backward
[**⏭/⏭**], [**▶**] or [**▶▶**]: Forward

When playing Video CDs with playback control

Pressing buttons to perform skip, search or slow-motion may take you to a menu screen.

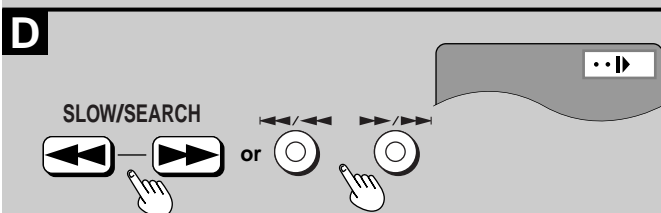
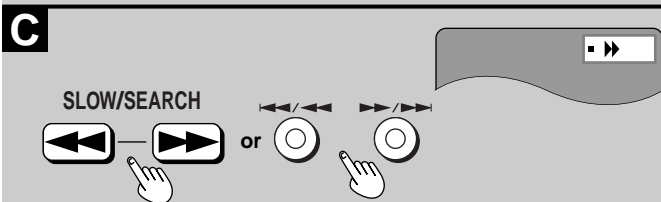
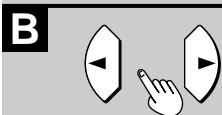
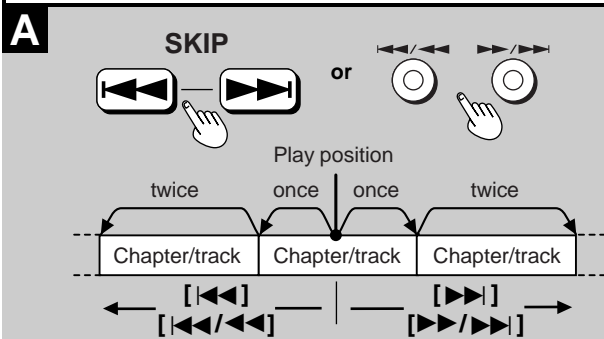

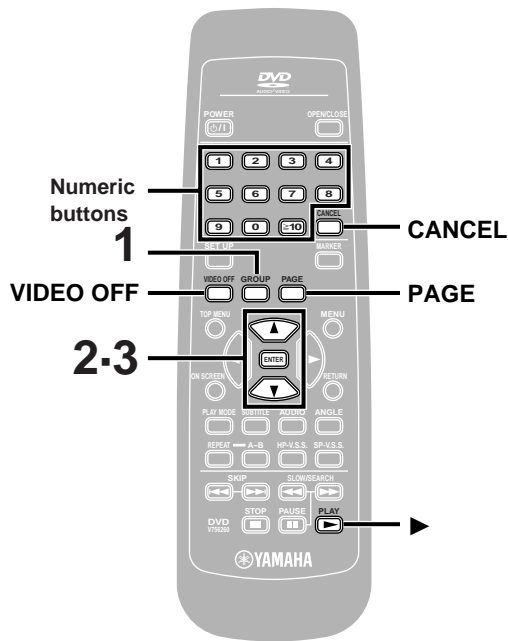
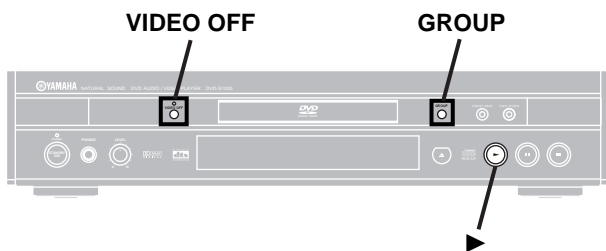
**A**

PAGE

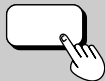

e.g. Page 1

PAGE 1

B

GROUP

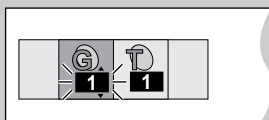
**C**

VIDEO OFF



Basic play

A Selecting still pictures–Page Skip**DVD-A****Remote control only**

Some DVD-Audio include still pictures that you can change with the following operation.

During play**Press [PAGE].**

The page changes each time you press the button.

B Selecting groups to play**DVD-A**

The tracks on DVD-Audio are divided into groups. How these groups are played differs with the disc so read the instructions that came with the disc for further details.

1 Press [GROUP].

The group and track icons are displayed.

2 Press the cursor buttons [▲, ▼] to select the group number and press [ENTER].**3** Press the cursor buttons [▲, ▼] to select the track number and press [ENTER].

The selected group and track begin to play.

- You can also select groups with the remote control's numeric buttons or [GROUP].

Press [▶] (PLAY) when the required group is selected to start play of that group.

- Selection may not be allowed in some situations.

Playing all the groups in succession (⇒ page 17)**Playing bonus groups**

Some discs contain bonus groups. To enjoy these groups you may have to enter a password.

- While stopped press [GROUP].
- Press the cursor buttons [▲, ▼] to select the bonus group and press [ENTER] or [▶] (PLAY).
- Enter the 4-digit password with the remote control's numeric buttons and press [ENTER].
 - See the disc's jacket for the password.
- Press the cursor buttons [▲, ▼] to select a track and press [ENTER] to start play.

- Some discs will show a menu screen for you to enter your password. Follow the instructions on the screen.

- The bonus group can be played as many times as you like after the password has been entered until the disc is removed from the unit.

Note

If you enter the wrong password, the previous screen will be displayed. Start again from the beginning. You can erase it by pressing [CANCEL].

C To enjoy even higher quality sound–VIDEO OFF**DVD-A** **DVD-V** **VCD** **CD**

You can enjoy higher quality audio by stopping the video signal.

Press [VIDEO OFF].

- The light above the button on the main unit lights.
- VIDEO OFF is canceled if you press the button again or turn the unit off. The light goes out.

Note

Video signals are output while the disc is stopped and when operations such as searching are performed. The television can appear unusual while video signals are not being output.

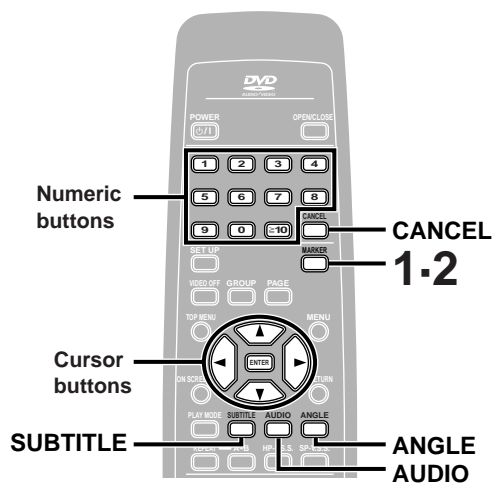

A Marking places to play again—MARKER

Remote control only

You can mark specific points on a disc to return to later. This feature only works if the elapsed playing time of the disc is shown on the unit's display. All the markers are cleared when the unit is turned off, or the disc tray is opened.

- 1 Press [MARKER].
The marker icon appears.
- 2 Press [MARKER] at the point you want to mark.
To select another marker, press the cursor buttons [◀, ▶].

To play from a marked position

Press the cursor buttons [◀, ▶] to select a marker number and press [ENTER].

To clear a marker

Press the cursor buttons [◀, ▶] to select a marker number and press [CANCEL].

Changing soundtracks, subtitle languages and angles

Remote control only

Some DVDs have multiple soundtracks, subtitle languages and camera angles, and you can change these during play.

B Soundtracks

DVD-A DVD-V

During play

Press [AUDIO].

The number changes each time you press the button.

- When playing DVD-Audio (other than moving picture sections), play restarts from the beginning of the current track when you change the audio.
- Even if a second soundtrack isn't recorded on a DVD-Audio, two soundtrack numbers will normally be shown when you press [AUDIO]. The soundtrack currently playing is number 1.
- You can also use this button to turn the vocals on and off on karaoke discs. Read the disc's instructions for details.

C Subtitles

DVD-A DVD-V

During play

Press [SUBTITLE].

The number changes each time you press the button.

To clear/display the subtitles

1. Press [SUBTITLE].
2. Press the cursor buttons [▶].
3. Press the cursor buttons [▲, ▼] to select "ON" or "OFF".

D Angles

DVD-A DVD-V

During play

Press [ANGLE].

The number changes each time you press the button.

Notes regarding soundtracks, subtitle languages and angles

- You can also use the cursor buttons [▲, ▼] or the numeric buttons to change the soundtracks, subtitle languages and angles.
- Some discs allow changes to soundtracks, subtitle languages and angles only by using the disc's menus.
- Soundtrack and subtitle languages can be set before play (→ page 24, Disc—Audio and Subtitle).
- "—" or "—" is displayed instead of the language number in circumstances such as when no language is recorded on the disc.
- Some discs allow you to set angles before multi-angle scenes are played. Read the instructions that come with the DVD.
- In some cases, the subtitle language is not changed to the selected one immediately.

A MARKER

1

2

B AUDIO

Soundtrack selected

Soundtrack playing

Indicates that a multi-channel soundtrack can be down-mixed.

Lights when a multi-channel soundtrack is playing.

e.g. DVD-Video

C SUBTITLE

DVD-Video

Subtitle language number

D ANGLE

Angle number

Changing the play sequence

Remote control only

Program play

DVD-A VCD CD

You can select up to 32 tracks to play in the order you choose.

- While stopped
Press [PLAY MODE] until the program play screen appears.
- Press [ENTER].
- DVD-Audio only**
Press the cursor buttons [▲, ▼] to select a group and press [ENTER].
• You can program tracks from different groups.
- Press the cursor buttons [▲, ▼] to select a track and press [ENTER].
Each time you press the cursor buttons,
1 ↔ 2 ← ----- → ALL
↑
• Repeat steps 2, 3 and 4 to program other tracks.
• You can also select a group or track with the numeric buttons.
• "Total Time" tells you the total time of the programmed tracks.
• All the tracks on a disc are selected when you select "ALL" (all the tracks in the selected group with DVD-Audio).
- Press [▶] (PLAY).
Play now begins in the programmed sequence.

To add or change tracks

- Press the cursor buttons [▲, ▼] to select an available item.
- Repeat steps 2–4 to make the changes.

To move to the page before or after the one shown

Press [◀◀] or [▶▶].

To clear the programmed tracks one by one

Press the cursor buttons to select the item number (No) and press [CANCEL]. Alternatively you can select "Clear" and press [ENTER].

To clear the whole program

Press the cursor buttons [▲, ▼, ◀, ▶] to select "Clear all" and press [ENTER].

The whole program is also cleared when the unit is turned off, or the disc tray is opened.

To exit the program mode

Press [PLAY MODE] while stopped until the program play screen disappears.

- The program is retained in memory.

Note

If you select bonus groups on DVD-Audio during program play, you will have to enter a 4-digit password (→ page 14).

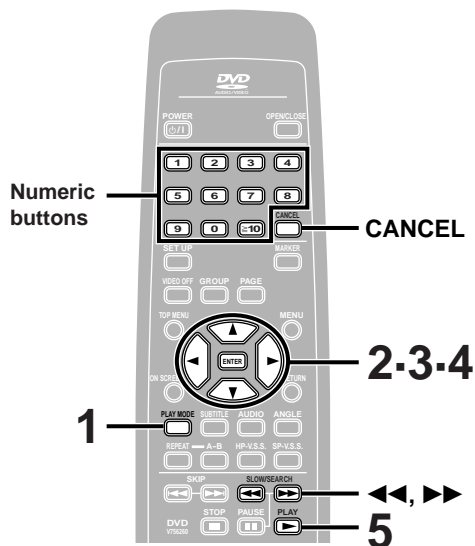

1 PLAY MODE

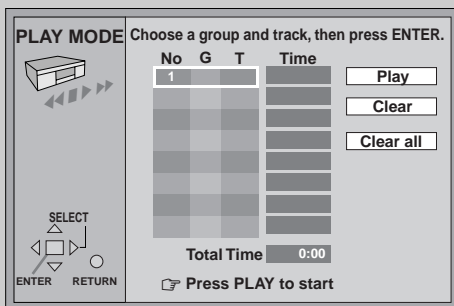

e.g. DVD-Audio



2 ENTER

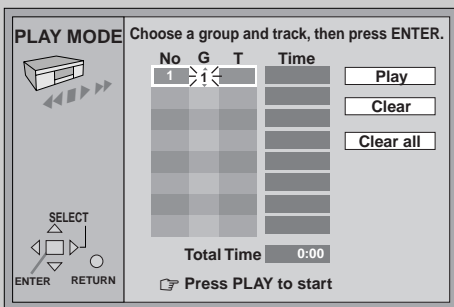

3-4

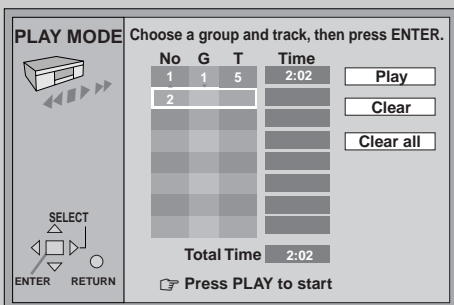

Group No. Track No. Program No.

5 PLAY



Changing the play sequence

Remote control only

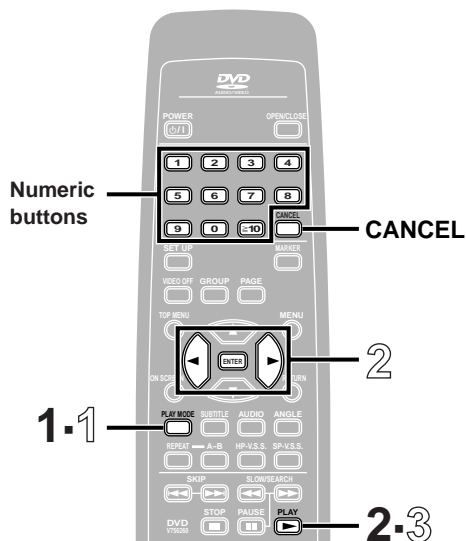

A All group play

DVD-A

The unit plays the tracks in all the groups on a disc.

- 1 While stopped
Press [PLAY MODE] until the all group play screen appears.
- 2 Press [▶] (PLAY).

B Random play

DVD-A VCD CD

The unit plays the tracks on a disc in random order.

- 1 While stopped
Press [PLAY MODE] until the random play screen appears.
- 2 **DVD-Audio only**
Press the cursor buttons [◀, ▶] to select a group and press [ENTER].
 - You can select more than one group.
 - You can also select groups with the numeric buttons.
- 3 Press [▶] (PLAY).
Play now begins in random order.

Advanced operations

A

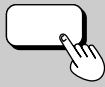
- 1 **PLAY MODE**

All Group Playback
Press PLAY to start

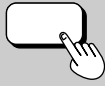

- 2 **PLAY**

B e.g. DVD-Audio (three groups)

- 1 **PLAY MODE**

Random Playback
Choose a group or groups
All 1 2 3

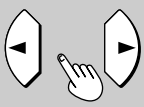
SELECT
ENTER RETURN
Press PLAY to start



- 2

Random Playback
Choose a group or groups
ALL 1 2 3
 *
SELECT
ENTER RETURN
Press PLAY to start



- 3 **PLAY**

To clear a group

DVD-Audio only

1. Press the cursor buttons [◀, ▶] to select the group you want to clear.
 2. Press [CANCEL] or [ENTER].
- Groups can also be erased by entering the group number with the numeric buttons.

To exit random mode

Press [PLAY MODE] while stopped until the random play screen disappears.

Note

If you select bonus groups on DVD-Audio during random play, you will have to enter a 4-digit password (➔ page 14).

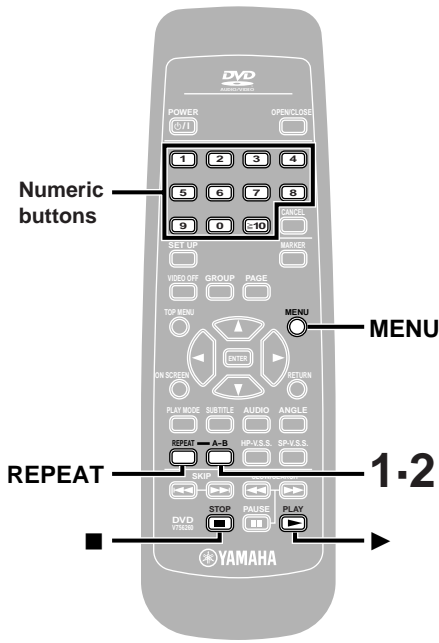

Repeat play

DVD-A DVD-V VCD CD

Remote control only

A Repeat play

During play

Press [REPEAT].

The display changes as illustrated.

•DVD-Audio/CD/Video CD

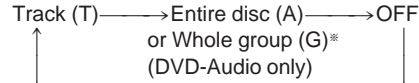

* When playing DVD-Audio, in All group, Program, or Random play modes, "A" is displayed instead of "G".

•DVD-Video

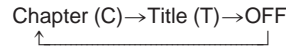

If the Video CD has playback control

Cancel menu play first.

1. Press [■] during play until "PBC Play" is cleared from the unit's display.
 2. Press the numeric buttons to select a track to start play.
 3. Press [REPEAT] (⇨ above).
- To return to menu play, press [■] and press [MENU].

Note

- Repeat play may not work as desired with some DVDs.
- Repeat play does not work if the disc's elapsed play time is not shown on the unit's display.
- There is no mode for repeating the whole DVD-Video.

■ To repeat only your favorite tracks

DVD-A VCD CD

1. Program the tracks you want (⇨ page 16).
2. Press [▶] (PLAY). Play will start.
3. Press [REPEAT] to display "↻T" or "↻A".

B A-B repeat play

You can repeat a section between points A and B within a title or track.

- 1 During play
Press [A-B] at the starting point (A).
- 2 Press [A-B] at the finishing point (B).

To cancel

Press [A-B] until "↻A-B" is displayed.

Note

- A-B repeat play does not work if the DVD's elapsed play time is not shown on the unit's display.
- Some subtitles recorded around point A or B may fail to appear.
- The unit automatically determines the end of a title/track as point B when the end of the title/track is reached.

A

REPEAT

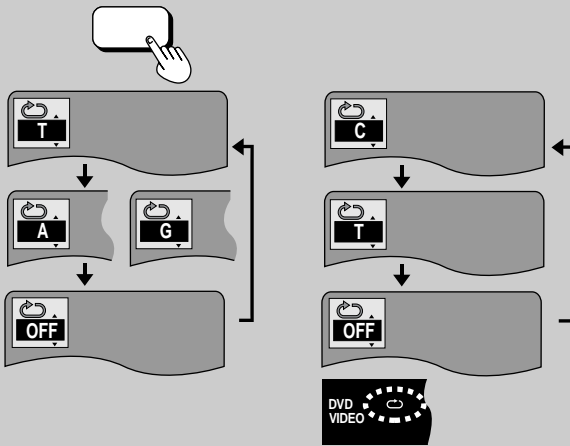

B

1

A-B



2

A-B



Increasing your enjoyment of movies and music

A Enjoying virtual surround effects with 2 speakers or headphones (VIRTUAL SURROUND (V.S.S.))

DVD-V VCD

SP-V.S.S.: Dolby Digital, DTS, MPEG, LPCM, 2-channel or over only

HP-V.S.S.: Dolby Digital, MPEG, LPCM, 2-channel or over only

Remote control only

Use VIRTUAL SURROUND (V.S.S.) (Virtual Surround Sound) to enjoy a surround-like effect if you are using two main speakers or headphones.

If you are playing a disc with surround effects recorded on it, the effect is broadened and sound seems to come from virtual speakers on either side.

Press [SP-V.S.S.] or [HP-V.S.S.].

Each time you press the button:

SP 1/HP 1: Natural effect → SP 2/HP 2: Emphasized effect
 ← SP OFF/HP OFF: Cancel (Factory preset) ←

Note

- Virtual Surround will not work, or will have less effect, with some discs, even if you select "1" or "2".
- Turn off the surround sound effects on the equipment you have connected when using this effect.
- Turn Virtual Surround off if it causes distortion.
- Output from this unit will be in stereo (two channels) when V.S.S. is on.

B Using headphones

1 Set [LEVEL] to "0" and connect the headphones (not included).

2 Adjust headphone volume with [LEVEL].

Note

Avoid listening for prolonged periods of time to prevent hearing damage.

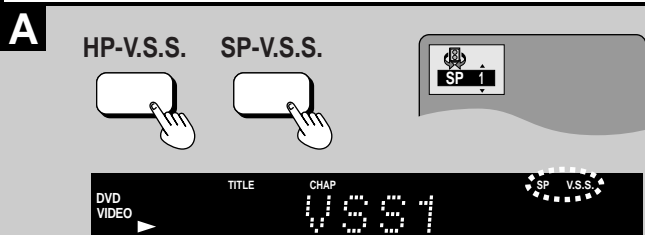
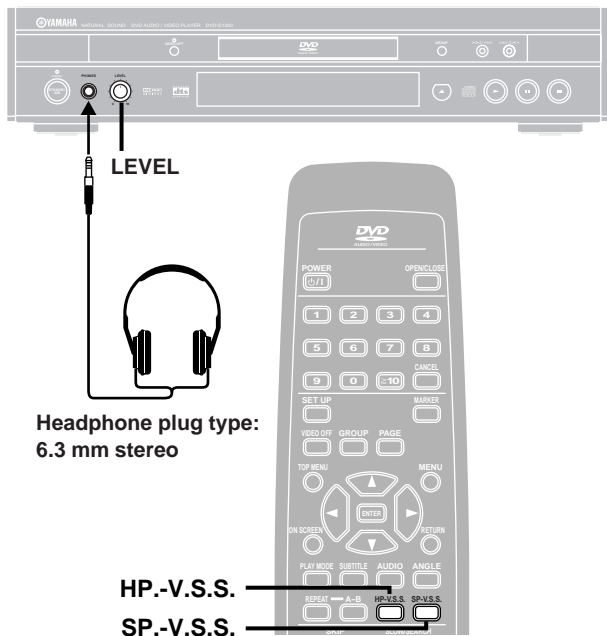

Optimum seating position

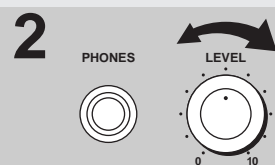
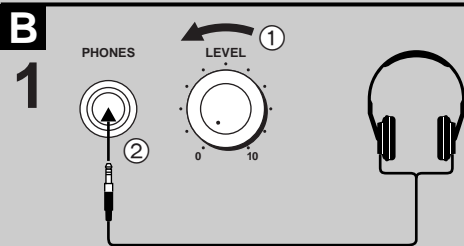
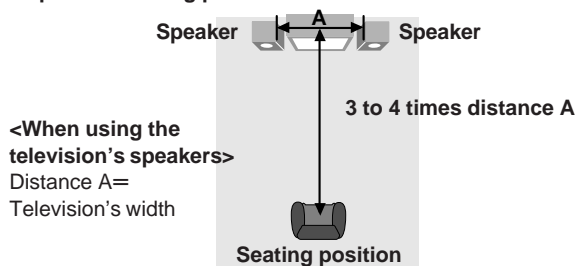

Using GUI screens

DVD-A DVD-V VCD CD

Remote control only

GUI (Graphical User Interface) screens are menus that contain information about the disc or unit. These menus allow you to perform operations by changing this information.

Common procedures

1 Press [ON SCREEN].

Each time you press the button:

- GUI screen for disc information (a)
- ↓
- GUI screen for unit information (b)
- ↓
- Shuttle screen (c)
- ↓
- Original display (d)

•The screens depend on the disc contents.

2

GUI screen for unit information only

While the leftmost icon is highlighted

Press the cursor buttons [▲, ▼] to select the menu.

Each time you press the cursor buttons:

- Play menu (e)
- ↓ ↑
- Display menu (f)
- ↓ ↑
- Audio menu (g)
- ↓ ↑
- Video menu (h)

3

Press the cursor buttons [◀, ▶] to select the item.

4

Press the cursor buttons [▲, ▼] to select the setting.

•Items with "▲" or "▼" above and below can be changed by [▲, ▼].

•Press [ENTER] if the setting does not change after pressing the cursor buttons [▲, ▼].

•Some items require different operations. Read the explanations on the following pages.

For your reference

•Some functions cannot be accessed from the stop mode (e.g. changing the soundtrack language).



•When numbers are displayed (e.g. title No.), the numeric buttons are also effective for setting. When numbers are entered with the numeric buttons, press [ENTER] to register the setting.

To clear the GUI screen

Press [RETURN] until the menus disappear.

■ To change the position of the GUI screens

You can lower the position of the GUI screens if they are cut off for some reason. There are 5 positions to choose from.

1. Press the cursor buttons [◀, ▶] to select the rightmost icon. 
2. Press the cursor buttons [▲, ▼] to move the GUI screen. 

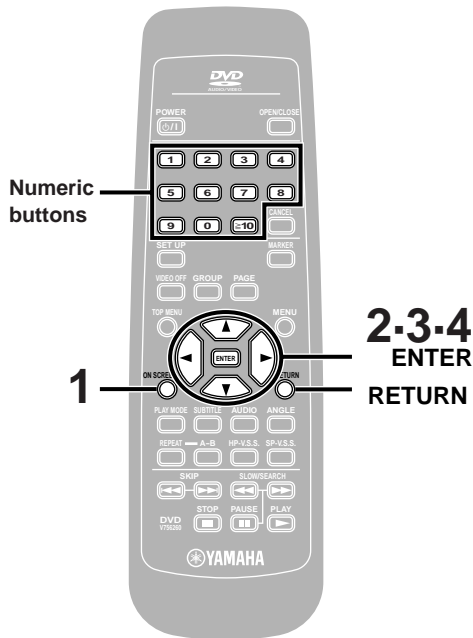

1 ON SCREEN



Example: DVD-Video

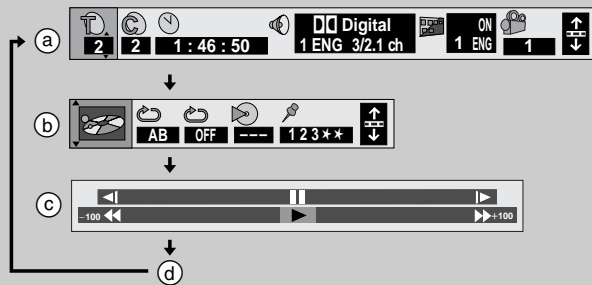

2

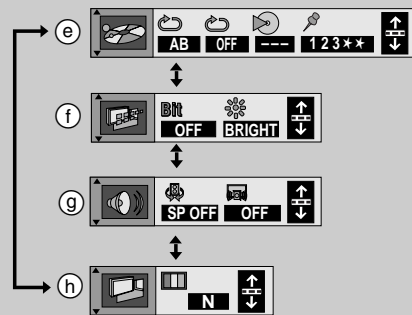
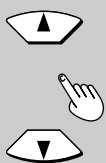

3

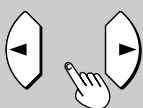

4

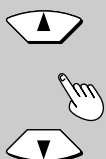

A

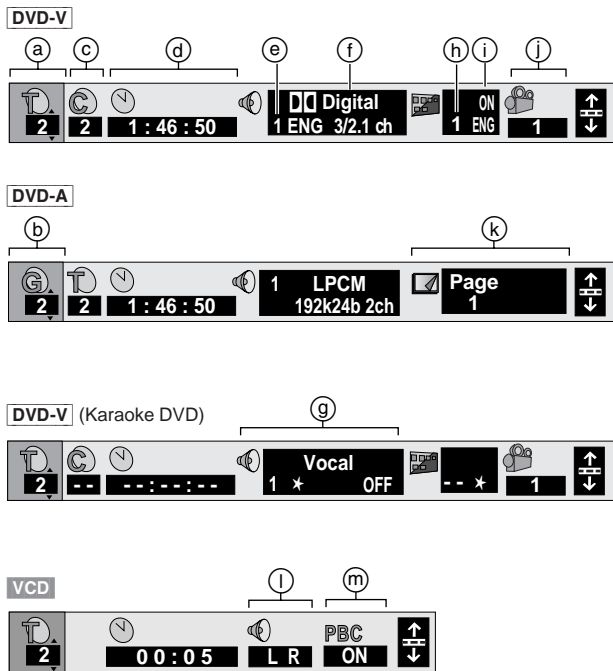

B

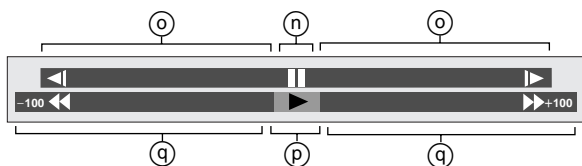

A Screen for disc information

Icon	Content
(a)	DVD-V Title number DVD-A VCD CD Track number
(b)	DVD-A Group number
(c)	DVD-V Chapter number
(d)	DVD-A DVD-V Time (select a position to start play by specifying a time with the numbered buttons) ----- DVD-A VCD CD Changing the time display Track elapsed time ↔ Track remaining time ↕ Disc remaining time ↕
(e)	DVD-A DVD-V Audio number (See a for language abbreviations.)
(f)	Audio signal type (See b for details.)
(g)	Karaoke vocal on/off (Karaoke DVD only) Solo: OFF or ON Duet: OFF, V1+V2, V1 or V2
(h)	DVD-A DVD-V Subtitle number (See a for language abbreviations.)
(i)	Subtitle on/off ON ↔ OFF
(j)	DVD-A DVD-V Angle number
(k)	DVD-A Still picture number Selected picture is shown during play.
(l)	VCD Audio mode LR ↔ L ↔ R
(m)	VCD (with playback control only) Menu play Indicates whether menu play (playback control) is on or off.

a Audio/Subtitle language

ENG: English	SVE: Swedish	CHI: Chinese
FRA: French	NOR: Norwegian	KOR: Korean
DEU: German	DAN: Danish	MAL: Malay
ITA: Italian	POR: Portuguese	VIE: Vietnamese
ESP: Spanish	RUS: Russian	THA: Thai
NLD: Dutch	JPN: Japanese	*: Others

b Signal type/data

LPCM/PPCM/Digital/DTS/MPEG: Signal type
k (kHz): Sampling frequency
b (bit): Number of bits
ch (channel): Number of channels

Example:

3/2 .1ch	.1: Subwoofer signal (not displayed if there is no subwoofer signal)
	0: No rear
	1: Mono rear
	2: Stereo rear (left/right)
	1: Center
	2: Main left+Main right
	3: Main left+Main right+Center

B Shuttle screen

Icon	Content
(n)	Pause
(o)	Slow-motion play ◀: Backward DVD-A DVD-V ▶: Forward DVD-A DVD-V VCD
(p)	Play
(q)	Search ◀◀: Backward ▶▶: Forward

- There are five speeds for both backward and forward slow-motion and search.
- The numbers on either side of the shuttle screen indicate the maximum speeds of the search.

Screen for unit information

A Play menu

Icon	Content
(a)	A-B repeat (⇒ page 18) [ENTER] (start point) ⇒ [ENTER] (finish point) To cancel: [ENTER]
(b)	Repeat play (⇒ page 18) DVD-V C (Chapter)↔T (Title)↔OFF DVD-A VCD CD T (Track)↔A (All)/G (Group)↔OFF
(c)	DVD-A VCD CD Play mode display ---: Off PGM: Program play RND: Random play ALL: All group play (DVD-A)
(d)	Marker: You can mark up to 5 positions to play again (⇒ page 15). [ENTER] (The unit is now ready to accept markers.) To mark a position: [ENTER] (at the desired point) To mark another position: [◀, ▶] ⇒ [ENTER] To recall a marker: [◀, ▶] ⇒ [ENTER] To erase a marker: [◀, ▶] ⇒ [CANCEL]

B Video menu

Icon	Content
(e)	DVD-A DVD-V VCD Digital picture mode To select the picture mode: [▲, ▼] N: Normal mode S: Soft mode (Soft picture with fewer video artifacts) F: Fine mode (Details are sharper) C: Cinema mode (Picture for viewing movies) U1, U2: User mode To change U1 and U2 1. Select User Mode and press the cursor button [▶]. 2. Press the cursor buttons [▲, ▼] to select 1 or 2. 3. Press the cursor buttons [◀, ▶] to select the item you want to change. 4. Press the cursor buttons [▲, ▼] to change the setting.
(f)	U1 Contrast (−7 to +7) Increases the contrast between white and black parts of the pictures.
(g)	Brightness (0 to +15) Brightens the picture.
(h)	Sharpness (−6 to +6) Adjust the horizontal resolution of the picture.
(i)	Colour (−7 to +7) Adjust the shade of the picture's colour.
(j)	Gamma (0 to +5) Increases the brightness of the center ranges to improve detail and contrast in dark scenes.
(k)	U2 3D-NR (0 to +4) Reduces overall noise.
(l)	Block NR (0 to +3) Smooths block noise.
(m)	Mosquito NR (0 to +3) Reduces the smudging that appears around contrasting sections of the picture.

Note

The unit saves the settings you make with the user mode for each disc so when you play a disc again and select a user mode, the same settings are selected. Discs you play for the first time use the previous settings. The unit can save settings for up to 200 discs. The settings for a disc are not saved if you switch to normal, soft, fine, or cinema mode before opening the disc tray or switching the unit to standby.

A

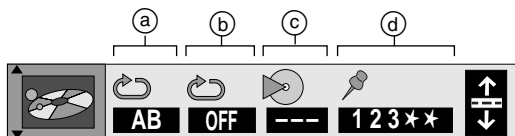

B

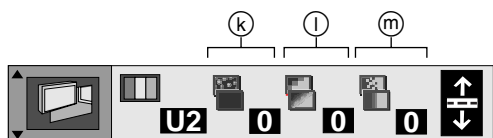
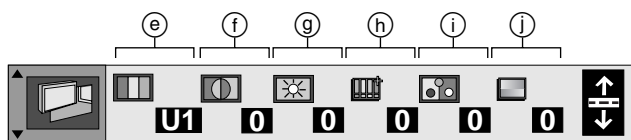

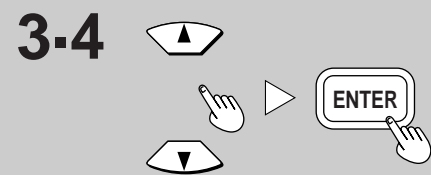
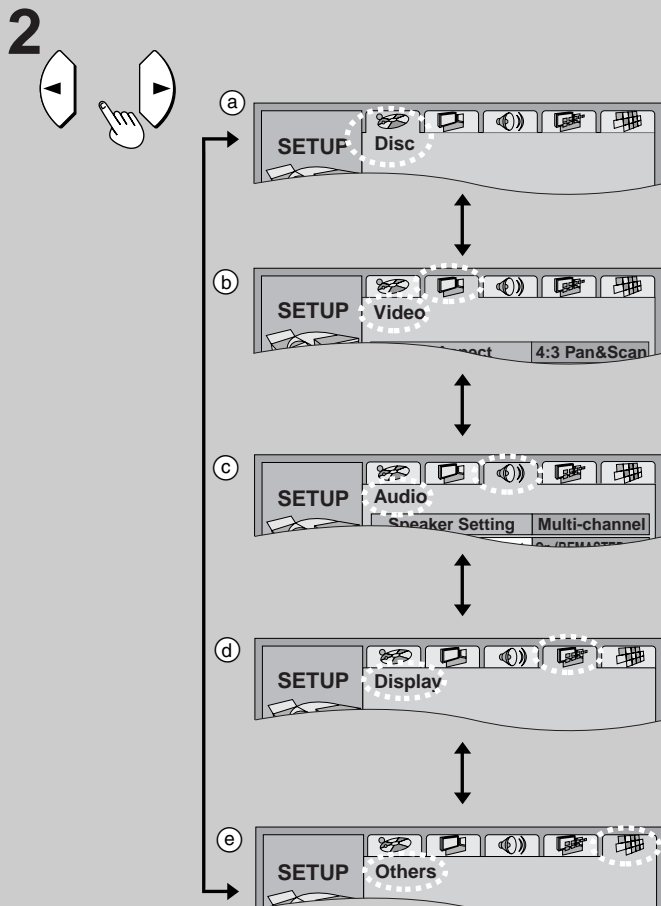
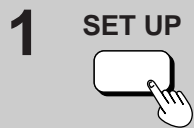
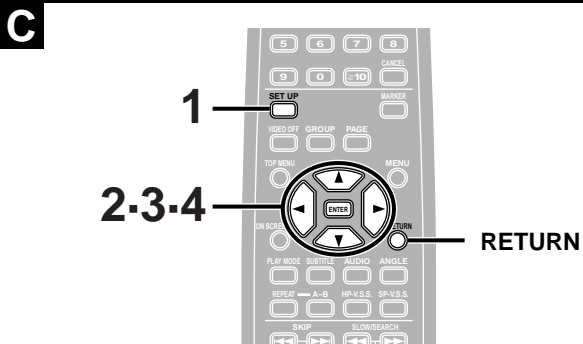
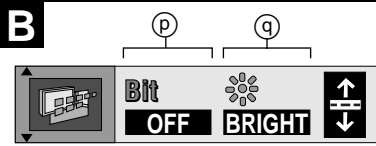
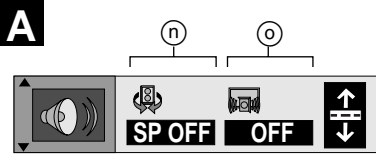

Using GUI screens

A Audio menu

Icon	Content
(n)	<p>DVD-V VCD</p> <p>VIRTUAL SURROUND V.S.S. mode (⇒ page 19) SP↔HP ●SP-V.S.S. (Dolby Digital, DTS, MPEG, LPCM, 2-channel or over only) ●HP-V.S.S. (Dolby Digital, MPEG, LPCM, 2-channel or over only)</p> <p>V.S.S. level (⇒ page 19) 1↔2↔OFF</p>
(o)	<p>DVD-V (Dolby Digital/DTS, 3-channel or over only)</p> <p>Dialogue Enhancer ON↔OFF The volume of the dialogue from the center channel is raised when you select "ON".</p>

B Display menu

Icon	Content
(p)	<p>DVD-V VCD</p> <p>Bit-rate display Displays the bit rate and type of picture (approximate values) During play: Shows the average bit rate of the video being played While paused: Shows the data volume of the frame ON↔OFF</p>
(q)	<p>Display dimmer: Changes the brightness of the unit's display. BRIGHT↔DIM↔AUTO*</p> <p>*The display dims and any indicators that were on turn off during play. The display brightens and the indicators light temporarily when you perform an operation.</p>

c Changing settings

Remote control only

Change the settings to suit your preferences and to suit the unit to the environment in which it is being used. These settings are retained in memory until they are changed, even if the unit is turned off.

Common procedures

See page 24 for menu and option details.

- 1 Press [SET UP] to show the menus.**
The screen shows the Disc menu (a) first.
- 2 Press the cursor buttons [◀, ▶] to select the menu's tab.**
The screen changes to display the menu.
Disc (a)↔Video (b)↔Audio (c)
↑↔Others (e)↔Display (d)↔
- 3 Press the cursor buttons [▲, ▼] to select the item you want to change and press [ENTER].**
- 4 Press the cursor buttons [▲, ▼] to select the option and press [ENTER].**
The screen now shows the menu again.

To return to the previous screen

Press [RETURN].

When you are finished

Press [SET UP].

Summary of settings

This chart shows the initial settings for this unit. See page 23 for details on menu operation.

- Underlined items are the factory presets.
- The menu and on-screen message language has been factory preset to English. You can change the language by going to “Menu Language” in the Display menu.

Menus	Items	Options
Disc (⇒ Remarks page 25)	Audio <u>DVD-A</u> <u>DVD-V</u> Choose the preferred audio language.	<u>English</u> French German Italian Spanish Original Other ****
	Subtitle <u>DVD-A</u> <u>DVD-V</u> Choose the preferred subtitle language.	<u>Automatic</u> English French German Italian Spanish Other ****
	Menus <u>DVD-A</u> <u>DVD-V</u> Choose the preferred language for disc menus.	<u>English</u> French German Italian Spanish Other ****
	Ratings <u>DVD-V</u> Set a ratings level to limit DVD-Video play.	Setting ratings (When level 8 is selected) 8 No Limit: All DVD-Video can be played. 1 to 7: Prohibits play of DVD-Video with corresponding ratings recorded on them. 0 Lock All: Prohibits play of all DVD-Video. ----- Changing ratings (When level 0–7 is selected) Unlock Player Change Level Change Password Temporary Unlock
Video <u>DVD-A</u> <u>DVD-V</u> <u>VCD</u>	TV Aspect Choose the setting to suit your television and preference (⇒ page 26).	<u>4:3 Pan&Scan</u> 4:3 Letterbox 16:9
	TV Type Change the setting to suit your television. (⇒ page 26)	<u>Standard</u> (Direct View TV) CRT Projector LCD Projector ProjectionTV
	AV 1 Output Choose the video signal format to be output from the AV1 SCART terminal.	<u>Video</u> S-Video RGB
	Still Mode (⇒ Remarks page 25) Specify the type of picture shown when paused.	<u>Automatic</u> Field Frame
	NTSC Disc Output Choose whether PAL 60 or NTSC signals are output during playback of NTSC discs (⇒ page 5).	<u>PAL60</u> : when connected to a PAL television. NTSC: when connected to an NTSC television.
Audio	Speaker Setting <u>DVD-A</u> <u>DVD-V</u> Choose the settings to suit your audio system and the listening environment (⇒ page 27).	<u>Multi-channel</u> : when 3 or more speakers are connected. • Speaker presence and size • Delay time • Channel balance ----- 2-channel: when 2 speakers or an amplifier with a Dolby Pro Logic decoder is connected.
	Digital Audio Output <u>DVD-A</u> <u>DVD-V</u> <u>VCD</u> <u>CD</u> Select whether to output digital signals or not. Select “Off” to enjoy high-quality sound through analog connection.	<u>On</u> : Digital signals are output. Off: Digital signals are not output.
	PCM Down Conversion <u>DVD-A</u> <u>DVD-V</u> Digital output of 96- or 88.2-kHz linear PCM signals (⇒ page 28)	No Yes
	Dolby Digital <u>DVD-A</u> <u>DVD-V</u> Digital output of Dolby Digital signals (⇒ page 28)	<u>Bitstream</u> PCM
	DTS Digital Surround <u>DVD-A</u> <u>DVD-V</u> Digital output of DTS Digital Surround signals (⇒ page 28)	<u>PCM</u> Bitstream
	MPEG <u>DVD-A</u> <u>DVD-V</u> Digital output of MPEG signals (⇒ page 28)	<u>PCM</u> Bitstream
	D. Range Compression <u>DVD-A</u> <u>DVD-V</u> (Dolby Digital only) Change the dynamic range for late night viewing.	Off On
	Audio during Search <u>DVD-A</u> <u>DVD-V</u> <u>VCD</u> (⇒ Remarks page 25) Choose whether to have sound during search.	On Off

Menus	Items	Options		
Display	Menu Language Choose the preferred language for these menus and the on-screen messages.	English Italiano	Français Español	Deutsch
	On-Screen Messages Choose whether to show on-screen messages or not.	On Off		
Others	Demo A demonstration of the unit's on-screen displays starts when you select "On". The demonstration stops when you press a button and the setting reverts to "Off".	Off On		

Remarks

■ Disc–Audio, Subtitle and Menu

Original: The original language of each disc will be selected.

Other **:** Input a code number with the numeric buttons (⇒ see below).

Automatic: If the language selected for "Audio" is not available, subtitles of that language will automatically appear if available on that disc.

● Some discs are designed to start in a certain language despite any changes you make here.

■ Disc–Ratings

● The password screen is shown if you choose levels 0 to 7 or if you choose "Ratings" when levels 0 to 7 have been selected (⇒ page 28).

● Select "Level 0" to prevent play of discs that do not have ratings levels recorded on them.

■ Video–Still Mode

Automatic: The unit automatically selects field still or frame still.

Field: Less blurred field stills are shown. Select if jittering occurs when "Automatic" is selected.

Frame: Sharper frame stills are shown. Select if small text or fine patterns cannot be seen clearly when "Automatic" is selected.

■ Audio–Audio during Search

Select "Off" if sound is interrupted when playing Dolby Digital 5.1-channel and DTS bitstream signals.

Audio will be heard when playing some DVD-Audio despite the settings you make here.

Language code list

Abkhazian: 6566	Chinese: 9072	Hausa: 7265	Lithuanian: 7684	Romanian: 8279	Telugu: 8469
Afar: 6565	Corsican: 6779	Hebrew: 7387	Macedonian: 7775	Russian: 8285	Thai: 8472
Afrikaans: 6570	Croatian: 7282	Hindi: 7273	Malagasy: 7771	Samoan: 8377	Tibetan: 6679
Albanian: 8381	Czech: 6783	Hungarian: 7285	Malay: 7783	Sanskrit: 8365	Tigrinya: 8473
Ameharic: 6577	Danish: 6865	Icelandic: 7383	Malayalam: 7776	Scots Gaelic: 7168	Tonga: 8479
Arabic: 6582	Dutch: 7876	Indonesian: 7378	Maltese: 7784	Serbian: 8382	Turkish: 8482
Armenian: 7289	English: 6978	Interlingua: 7365	Maori: 7773	Serbo-Croatian: 8372	Turkmen: 8475
Assamese: 6583	Esperanto: 6979	Irish: 7165	Marathi: 7782	Shona: 8378	Twi: 8487
Aymara: 6588	Estonian: 6984	Italian: 7384	Moldavian: 7779	Sindhi: 8368	Ukrainian: 8575
Azerbaijani: 6590	Faroese: 7079	Japanese: 7465	Mongolian: 7778	Singhalese: 8373	Urdu: 8582
Bashkir: 6665	Fiji: 7074	Javanese: 7487	Nauru: 7865	Slovak: 8375	Uzbek: 8590
Basque: 6985	Finnish: 7073	Kannada: 7578	Nepali: 7869	Slovenian: 8376	Vietnamese: 8673
Bengali; Bangla: 6678	French: 7082	Kashmiri: 7583	Norwegian: 7879	Somali: 8379	Volapük: 8679
Bhutani: 6890	Frisian: 7089	Kazakh: 7575	Oriya: 7982	Spanish: 6983	Welsh: 6789
Bihari: 6672	Galician: 7176	Kirghiz: 7589	Pashto, Pushto: 8083	Sundanese: 8385	Wolof: 8779
Breton: 6682	Georgian: 7565	Korean: 7579	Persian: 7065	Swahili: 8387	Xhosa: 8872
Bulgarian: 6671	German: 6869	Kurdish: 7585	Polish: 8076	Swedish: 8386	Yiddish: 7473
Burmese: 7789	Greek: 6976	Laotian: 7679	Portuguese: 8084	Tagalog: 8476	Yoruba: 8979
Byelorussian: 6669	Greenlandic: 7576	Latin: 7665	Punjabi: 8065	Tajik: 8471	Zulu: 9085
Cambodian: 7577	Guarani: 7178	Latvian, Lettish: 7686	Quechua: 8185	Tamil: 8465	
Catalan: 6765	Gujarati: 7185	Lingala: 7678	Rhaeto-Romance: 8277	Tatar: 8484	

Television settings

Change the settings to suit your television and your preference. Refer also to Common Procedures (➔ page 23) and the Video section in Summary of settings (➔ page 24).

TV Aspect

4:3 Pan&Scan (Factory preset)

Select if you have a regular television and to view 16:9 software in the pan and scan style.



16:9 software prohibited from being shown in the pan and scan style will appear in the letterbox style despite the setting here.

4:3 Letterbox

Select if you have a regular television and to view 16:9 software in the letterbox style.



16:9

Select if you have a widescreen television.

For your reference

DVDs are recorded in a variety of aspect ratios and how these appear depend on these settings, the on-screen menu settings, and the television's screen modes.

- When connected to a regular 4:3 aspect television, use these settings.
- When connected to a widescreen 16:9 aspect television, use the television's screen modes.

TV Type

Standard (Direct View TV) (Factory preset)

Select if you have a standard television, widescreen television, wide-screen plasma television, etc.

CRT Projector

Select if you have a DLP Projector or a CRT Projector.

LCD Projector

Select if you have an LCD Projector.

Projection TV

Select if you have a Projection TV.

The optimum settings for your television may differ.

Speaker setting

DVD-A DVD-V

Select either "2-channel" or "Multi-channel" to suit the speakers you have connected. You can change the following settings when you select "Multi-channel".

A Speaker presence and size

1. Use the cursor buttons [▲, ▼, ◀, ▶] to select the item and press [ENTER].
2. Press the cursor buttons [▲, ▼] to select the setting and press [ENTER].

Icon examples: Rear speaker (L)

Large: When the speaker supports low-frequency (under 100 Hz) reproduction.

Small: Select when the speaker does not support low-frequency reproduction.

The size setting for the main speakers is automatically determined by the setting for the subwoofer.

B Delay time

DVD-V (Dolby Digital, center and rear speakers only)

For optimum listening with 5.1-channel sound, all the speakers, except for the subwoofer, should be the same distance from the seating position. If you have to place the center or rear speakers closer to the seating position, adjust the delay time to make up for the difference. If distance (a) (from the center speaker) and (c) (from the rear speakers) are the same as or greater than (b) (from the main speakers), leave the delay time as "0", the factory preset.

If either distance (a) or (c) is less than (b), find the difference in the relevant table and change to the recommended setting.

Changing the delay time

1. Use the cursor buttons [▲, ▼, ◀, ▶] to select the delay time box and press [ENTER].
2. Press the cursor buttons [▲, ▼] to adjust the delay time and press [ENTER].

C Speaker balance

1. Use the cursor buttons [▲, ▼, ◀, ▶] to select "Test" and press [ENTER].

A test signal is output from one speaker at a time, starting with the main left speaker and proceeding clockwise.

MAIN (L) → CENTER → MAIN (R)

↑ REAR (L) ← REAR (R) ↓

2. While listening to the test signal, press the cursor buttons [▲, ▼] to adjust the volume of the center and rear speakers so they are the same apparent volume as the main speakers (-6 dB to +6 dB).
(The main speakers cannot be adjusted here.)

(The main speakers cannot be adjusted here.)

3. Press [ENTER].
The test signal stops.

Note

- Test signal is effective only when you made analog connection. When you make digital connection, make adjustment using the test tone on the amplifier.
- No signal is output for the subwoofer. To adjust its volume, play something, then return to this screen to adjust to suit your taste.

When you are finished

Use the cursor buttons [▲, ▼, ◀, ▶] to select "Exit" and press [ENTER].

Note

The unit may be unable to output as set here due to limitations imposed by the unit itself or the disc being played. (The FL display's "P.PCM" indicator lights or "D.MIX" indicator goes out in these cases.)

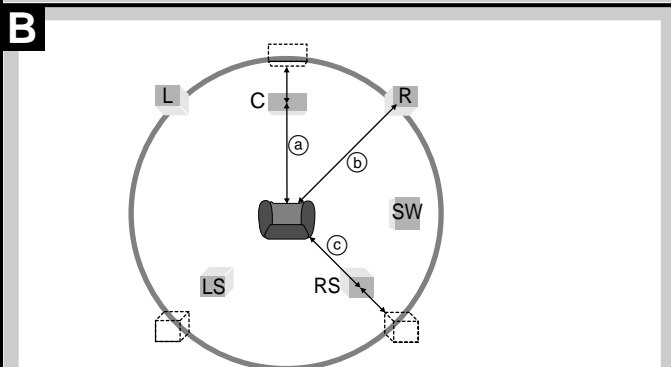
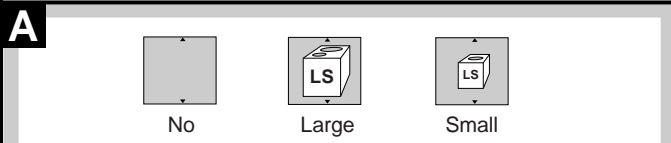
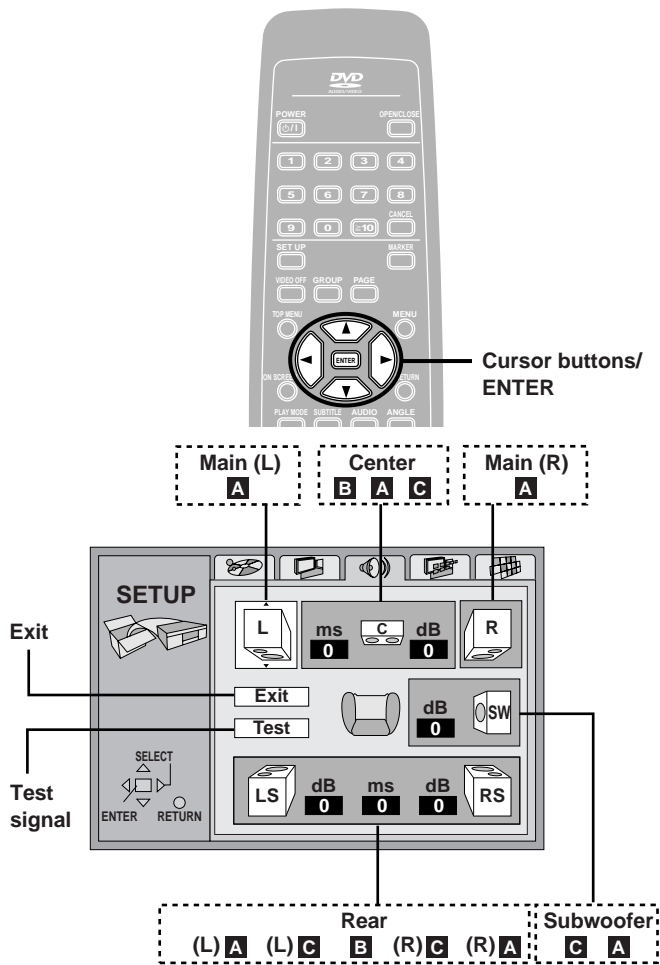

Center speaker

Difference	Setting
Approx. 50 cm	1.3 ms
Approx. 100 cm	2.6 ms
Approx. 150 cm	3.9 ms
Approx. 200 cm	5.3 ms

Rear speakers

Difference	Setting
Approx. 200 cm	5.3 ms
Approx. 400 cm	10.6 ms
Approx. 600 cm	15.9 ms

Digital output

Refer also to “Common procedures” (⇒ page 23) and the Audio menu in “Summary of settings” (⇒ page 24).

PCM Down Conversion

DVD-A | DVD-V

Select how to output the high-quality audio signals (sampling frequencies of 96 kHz and 88.2 kHz) on discs that do not have copyright protection. Choose the settings to suit the equipment you have connected.

Setting	Equipment (Able to handle 88.2 kHz or more)	Audio output
No*1	Yes	Output as is
Yes	No	Down-sampled to 48 kHz or 44.1 kHz

*1 The equipment cannot output signals of 88.2 kHz or more if the setting is “No” and the equipment is unable to handle these signals.

Note

Signals are down-sampled to either 48 kHz or 44.1 kHz despite the above settings if they have a sampling frequency of 176.4 kHz or more or are copyright protected.

Dolby Digital

DVD-A | DVD-V

Bitstream (Factory preset):

When you have connected a unit with a built-in Dolby Digital decoder.

PCM:

When you have connected a unit that doesn't have a built-in Dolby Digital decoder.*2

DTS Digital Surround

DVD-A | DVD-V

PCM (Factory preset):

When you have connected a unit that doesn't have a built-in DTS decoder.*2

Bitstream:

When you have connected a unit with a built-in DTS decoder.

MPEG

DVD-A | DVD-V

PCM (Factory preset):

When you have connected a unit that doesn't have a built-in MPEG decoder.*2

Bitstream:

When you have connected a unit with a built-in MPEG decoder.

*2 These changes to digital audio output must be made, otherwise bitstream signals the decoder cannot handle will be output. If these signals are output, “noise” will be output which can cause harm to your ears and speakers.

Entering a password

DVD-V

Refer also to “Common procedures” (⇒ page 23) and the Disc menu in “Summary of settings” (⇒ page 24).

When setting ratings (When the level is 8)

The password screen is shown when you select levels 0 to 7.

1. Input a 4-digit password with the numeric buttons and press [ENTER].

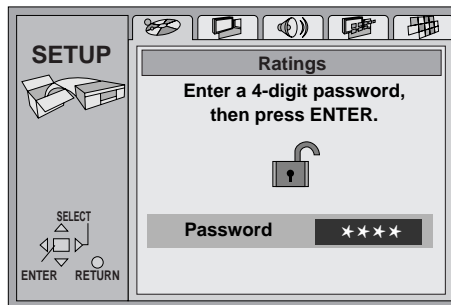

- If you enter a wrong number, press [CANCEL] to erase it before you press [ENTER].

The lock symbol appears closed to show the rating is locked.

Do not forget your password.

2. Press [ENTER] to confirm the 4 digits.

Now, when you insert a DVD-Video that exceeds the ratings limit you set, a message appears on the television. Follow the on-screen instructions.

When changing ratings (When the level is 0 to 7)

The password screen is shown when you select “Ratings”.

1. Input your 4-digit password with the numeric buttons and press [ENTER].

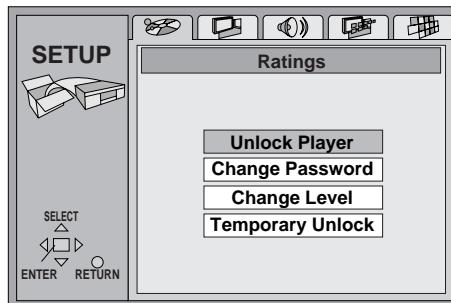

2. Select the item with the cursor buttons [▲, ▼] and press [ENTER], and follow the on screen instructions.

Bitstream

This is the digital form of multiple channel audio data (e.g., 5.1 channel) before it is decoded into its various channels.

Decoder

A decoder restores the coded signals on DVDs to normal. This is called decoding.

Dolby Digital

This is a method of coding digital signals developed by Dolby Laboratories. Apart from stereo (2-channel) audio, these signals can also be 5.1-channel audio. A large amount of audio information can be recorded on one disc using this method.

Dolby Pro Logic

A surround system where a 4-channel audio track is recorded as 2 channels and then is restored to 4 channels for play. The surround channel is monaural and can reproduce up to 7 kHz.

DTS (Digital Theater Systems)

This surround system is used in many movie theaters around the world. There is good separation between the channels, so realistic sound effects are possible.

Dynamic range

Dynamic range is the difference between the lowest level of sound that can be heard above the noise of the equipment and the highest level of sound before distortion occurs.

Frame still and field still

A still is shown when you pause a moving picture. A frame still is made up of two alternating fields, so the picture may appear blurred, but overall quality is high.

A field still is not blurred, but it has only half the information of a frame still so picture quality is lower.

Frames are the still pictures that go together to make a moving picture. There are about 30 frames shown each second.

One frame is made up of two fields. A regular television shows these fields one after the other to create frames.

I/P/B

MPEG, the video compression standard adopted for use with DVD-Video, codes frames using these 3 picture types.

I: Intra coded picture (I-picture)

This is the standard picture and is a complete picture in itself.

This means it has the best picture quality and is the best to use when adjusting the picture.

P: Predictive coded picture (P-picture)

This picture is calculated based on past I or P-pictures.

B: Bidirectionally-predictive coded picture (B-picture)

This picture is calculated by comparing past and future I and P-pictures so it has the lowest volume of information.

Linear PCM (pulse code modulation)

PCM is the usual digital method used for music CDs. DVDs have a greater volume so they use linear PCM, which has a higher sampling rate. Compressed PCM signals are called packed PCM (PPCM).

Optical digital audio cable

Electronic signals are converted to optical signals for output to the amplifier. This reduces noise caused by electronic interference.

Pan&Scan/Letterbox

In general, DVD-Video are produced with the intention that they be viewed on a widescreen television with an aspect ratio of 16:9. This means you can view most material with the intended aspect ratio on a widescreen television.

Material with this ratio will not fit onto a standard television with an aspect ratio of 4:3. Two styles of picture, "Pan&Scan" and "Letterbox", deal with this problem.

Pan&Scan: the sides are cut off so the picture fills the screen.

Letterbox: black bands appear at the top and bottom of the picture so the picture itself appears in an aspect ratio of 16:9.

Playback control (PBC)

If a Video CD has "playback control" written on it or its jacket, it means that particular scenes or information can be selected for viewing interactively with the television using the menu screen. This unit can play Video CDs with playback control.

Using menus to control play of a Video CD is called "menu play" in these operating instructions.

Sampling rate

This is the number of samples of sound taken per second during conversion to a digital signal. Sampling frequency is expressed in kilohertz (kHz). A high sampling frequency results in a sound close to the original when played back.

Title/Chapter

DVD-Video are divided up into large sections, titles, and smaller sections, chapters. The numbers allocated to these sections are called title numbers and chapter numbers.

Track

This is the smallest division on DVD-Audio, CD, and Video CD, and usually equates to a single song.

Disc handling

Do not use irregularly shaped discs, such as heart-shaped. (These can damage the unit.)

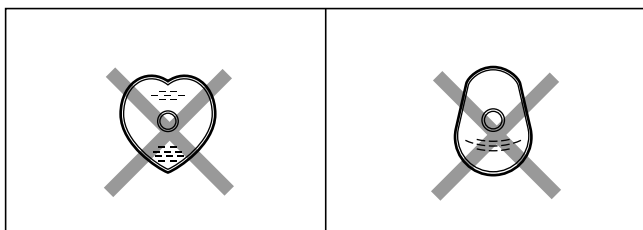

How to hold a disc

Do not touch the recorded surface.

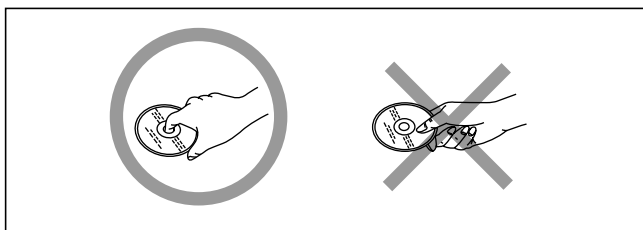

If the surface is dirty

Wipe it with a damp cloth and then wipe dry.

Do not wipe with a circular motion; wipe straight outward from the center.

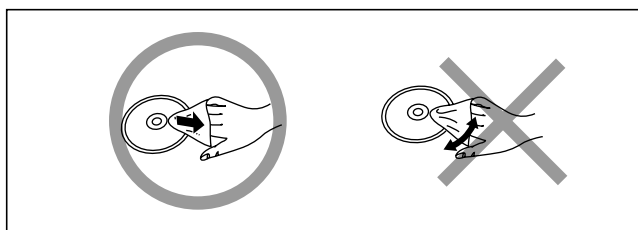

If the disc is brought from a cold to a warm environment, moisture may form on the disc

Wipe with a soft, dry, lint-free cloth before using the disc.

Handling precautions

- Do not write on the label side with a ball-point pen or other writing instrument.
- Do not use record cleaning sprays, benzene, thinner, static electricity prevention liquids or any other solvent.
- Do not attach labels or stickers to discs. (Do not use discs with exposed adhesive from tape or left over peeled-off stickers.)
- Do not use scratch-proof protectors or covers.
- Do not use discs printed with label printers available on the market.

Do not place or store discs in the following places

- Locations exposed to direct sunlight
- Humid or dusty locations
- Locations directly exposed to a heat vent or heating appliance

Troubleshooting guide

Before requesting service for this player, check the chart below for a possible cause of the problem you are experiencing. Some simple checks or a minor adjustment on your part may eliminate the problem and restore proper operation.

If you are in doubt about some of the check points, or if the remedies indicated in the chart do not solve the problem, contact your authorized YAMAHA dealer or service center for instructions.

Reference pages are shown as black circled numbers ❸.

Power

No power.	<ul style="list-style-type: none"> ● Insert the AC mains lead securely into the household mains socket. ❷
The unit is automatically switched to the standby mode.	<ul style="list-style-type: none"> ● To conserve power, the unit automatically switches to the standby mode after approx. 30 minutes elapse in the stop mode (Auto standby). Turn the power back to ON.

Operation

No response when buttons pressed.	<ul style="list-style-type: none"> ● Some operations may be prohibited by the disc. ● The unit may not be operating properly due to lightning, static electricity or some other external factor. Reset procedure: Press [STANDBY/ON] to switch the unit to the standby mode and then back to ON. Alternatively, press [STANDBY/ON] to switch the unit to the standby mode, disconnect the AC mains lead, and then reconnect it.
No operations can be performed with the remote control.	<ul style="list-style-type: none"> ● Check the batteries are installed correctly. ❹ ● The batteries are depleted: Replace them with new ones. ❹ ● Point the remote control at the remote control sensor and operate. ❹
Play fails to start even when [▶] (PLAY) is pressed. Play starts but then stops immediately.	<ul style="list-style-type: none"> ● Condensation has formed: Wait 1 to 2 hours for it to evaporate. ● This unit cannot play discs other than DVD-Audio, DVD-Video, Video CD and CD. ❺ ● You can only play DVD-Video if their region number is the same or includes the same region number as the unit or if the DVD-Video is marked "ALL". Confirm the region number for the unit on the rear panel. ❺ ● The disc may be dirty and may require cleaning. ❷ ● Ensure that the disc is installed with the label of the side to be played facing upwards. ❶
Alternative languages fail to be selected.	<ul style="list-style-type: none"> ● An alternative language is not selected with discs which do not contain more than one language. ● In the case of some discs, the alternative language cannot be selected with [AUDIO] or [SUBTITLE]. Try selecting it from the disc's menu if one is available. ❶
No subtitles.	<ul style="list-style-type: none"> ● Subtitles appear only with discs that contain them. ● Subtitles are cleared from the television. Display the subtitles. ❶ ● Some subtitles recorded around point A or B may fail to appear. ❶
Soundtrack and/or subtitle language is not the one selected with the SET UP menus.	<ul style="list-style-type: none"> ● The language is not recorded on the disc.
Angle cannot be changed.	<ul style="list-style-type: none"> ● This function is dependent on software availability. Even if a disc has a number of angles recorded, these angles may be recorded for specific scenes only. ❶
You have forgotten your ratings password. Reset all the settings to Factory Preset.	<ul style="list-style-type: none"> ● While stopped, press and hold [⏪/◀] and [⏩/▶] on the unit and then also press and hold [▲] on the unit until "Initialized" disappears from the television. Turn the unit off and on again. All settings will return to the default values.

Sound

No sound. Distorted sound.	<ul style="list-style-type: none"> ● Check the connections. ❷ ❸ ❹ ● Check the volume on the equipment you have connected. ● Ensure that the input settings for the television and stereo system are correct. ● If you have connected this unit to an amplifier through the AUDIO OUT terminals, go to Audio in the SET UP menus, and change "Speaker Setting" to suit your speakers. Select the large or small icon for all the speakers you have connected. ❷ ● Turn Virtual Surround off if it causes distortion. ❶ ● Sound will only come from the 2 main speakers if Virtual Surround is on. Turn Virtual Surround off if you are using three or more speakers. ❶ ● While playing DVD-Audio that has video content, press [VIDEO OFF] to stop video output. ❶ ● Due to the specifications on some types of televisions, both video and audio may be cut off when you turn the VIDEO OFF feature on. ❶ ● If the "D.MIX" indicator on the FL display goes out while playing a multi-channel DVD-Audio disc, sound will only be output from speakers specified by the disc. Read the disc's instructions for details. ● "Error" on the FL display indicate that the track playing has been recorded with a nonstandard system. ● If you have used analog connection (➡ page 6), go to the Audio menu and set "Digital Audio Output" to "Off". ❷
----------------------------	---

Sound

Piercing noise comes from the speakers.	<ul style="list-style-type: none"> ● If you have connected this unit to other equipment through the DIGITAL AUDIO OUT terminal, ensure you have selected the correct settings for “Dolby Digital”, “DTS Digital Surround” and “MPEG” in the SET UP menus’ Audio menu. 28
---	---

Picture

Picture distorted.	<ul style="list-style-type: none"> ● Some distortion is normal during SEARCH. ● The screen may be disrupted briefly when you turn off the VIDEO OFF feature.
No picture.	<ul style="list-style-type: none"> ● Ensure that the equipment is connected properly. 7 8 9 ● Make sure the television is on. ● Ensure the television’s video input setting (e.g., VIDEO 1) is correct.
The picture shown on the television is not normal. (The sides of the picture are cut off or black bands appear at the top and bottom of the screen.)	<ul style="list-style-type: none"> ● Go to the Video menu in the SET UP screen, and change “TV Aspect” to suit your television. You may also need to change the screen mode on the television itself. 26 ● Ensure that the unit is not connected through a video cassette recorder. 7
There is a lot of ghosting.	<ul style="list-style-type: none"> ● Use the on-screen menu icons to adjust the picture quality. 22

Displays

“No Play” appears on the unit’s display.	<ul style="list-style-type: none"> ● You inserted a disc the unit cannot play; insert one it can. 5
No on-screen display.	<ul style="list-style-type: none"> ● Go to Display in the SET UP menus, and select “On” for “On-Screen Messages”. 25
GUI screens not displayed or only partially displayed on the television.	<ul style="list-style-type: none"> ● Move the cursor buttons [▲, ▼] while the rightmost icon is highlighted to move them down. 20
The disc’s menu is displayed in a different language.	<ul style="list-style-type: none"> ● Go to Disc in the SET UP menus, and select the preferred language for “Menus”. 24
No menu play.	<ul style="list-style-type: none"> ● Menus are only displayed if they are recorded on the disc.
“Check The Disc” appears on the unit’s display.	<ul style="list-style-type: none"> ● Disc is dirty. Wipe the disc clean. 29
<p>“H□□” appears on the unit’s display.</p> <p>□□ stands for a number.</p>	<ul style="list-style-type: none"> ● Trouble is likely to have occurred. The number following “H” depends on the status of the unit. Reset procedure: Press [STANDBY/ON] to switch the unit to the standby mode and then back to ON. Alternatively, press [STANDBY/ON] to switch the unit to the standby mode, disconnect the AC mains lead, and then reconnect it. ● If the service numbers fail to clear, note the service number and contact a qualified service person.
“No Disc” appears on the unit’s display.	<ul style="list-style-type: none"> ● You haven’t inserted a disc; insert one. ● You haven’t inserted the disc correctly; insert it correctly. 11

Maintenance

To clean this unit, wipe with a soft, dry cloth.

- Never use alcohol, paint thinner or benzine to clean this unit.
- Before using chemically treated cloth, read the instructions that came with the cloth carefully.

Specifications

Power supply:	AC 220–240 V, 50 Hz
Power consumption:	19 W
Power consumption in standby mode:	approx. 4 W
Dimensions:	449 (W)×281 (D)×99 (H) mm (excluding protrusions)
Weight:	3.5 kg
Signal system:	PAL 625/50, PAL 525/60, NTSC
Operating temperature range:	+5 to +35 °C
Operating humidity range:	5–90 % RH (no condensation)
Discs played:	DVD-Video DVD-Audio CD-Audio (CD-DA) Video CD CD-R/RW (CD-DA, Video CD formatted discs)
Video output:	
Output level:	1 Vp-p (75 Ω)
Output connector:	Pin jack (2 systems)/AV1/AV2
S video output:	
Y output level:	1 Vp-p (75 Ω)
C output level:	NTSC; 0.286 Vp-p (75 Ω) PAL; 0.300 Vp-p (75 Ω)
Output connector:	S terminal (1 system), AV1

RGB video output:	
R output level:	0.7 Vp-p (75 Ω)
G output level:	0.7 Vp-p (75 Ω)
B output level:	0.7 Vp-p (75 Ω)
Output connector:	AV1
Number of connectors:	1 system
Audio output:	
Output level:	2 Vrms (1 kHz, 0 dB)
Output connector:	Pin jack/AV1/AV2
Number of connectors:	
2CH:	1 system
5ch discrete output (5.1ch):	1 system
Audio signal output characteristics:	
(1) Frequency response:	
•DVD (linear audio):	2 Hz–22 kHz (48 kHz sampling) 2 Hz–44 kHz (96 kHz sampling) 2 Hz–88 kHz (192 kHz sampling) 2 Hz–20 kHz
•CD audio:	
(2) S/N ratio:	
•CD audio:	115 dB
(3) Dynamic range:	
•DVD (linear audio):	103 dB
•CD audio:	99 dB
(4) Total harmonic distortion:	
•CD audio:	0.002 %
Digital audio output:	
Optical digital output:	Optical terminal
Coaxial digital output:	Pin jack
PHONES jack:	Stereo, 6.3 mm jack
Pickup:	
Wave length:	658 nm/790 nm
Laser power:	CLASS 2/CLASS 1

Note

Specifications are subject to change without notice.
Weight and dimensions are approximate.

This product incorporates copyright protection technology that is protected by method claims of certain U.S. patents and other intellectual property rights owned by Macrovision Corporation and other rights owners. Use of this copyright protection technology must be authorized by Macrovision Corporation, and is intended for home and other limited viewing uses only unless otherwise authorized by Macrovision Corporation. Reverse engineering or disassembly is prohibited.