

# YAMAHA

AM/FM STEREO RECEIVER

# CR-840

## OWNER'S MANUAL

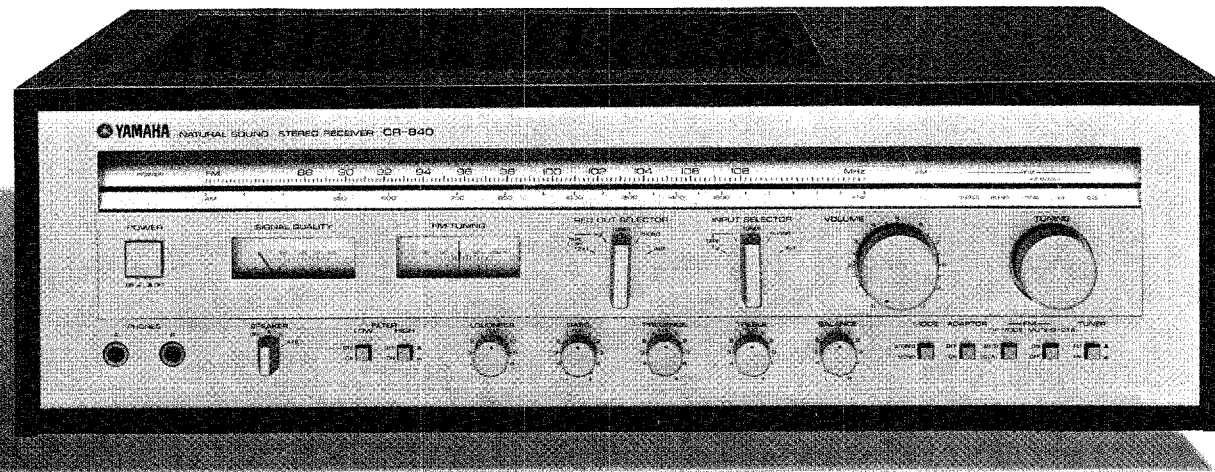

CENTER

U/C

# CR-840

## CONTENTS

*YAMAHA offers you thanks and congratulations on your choice of the CR-840 Receiver. Embodying the most up-to-date and useful features, it combines superb broadcast reception with the finest audio quality, and is currently setting new standards for receiver performance in its class.*

### SPECIAL FEATURES OF THE CR-840 RECEIVER

#### 1. All-in-One Excellence

Accurately matched performance specifications, functions, and controls, provide an overall performance which fully measures up to Yamaha's high tuner, preamplifier, and power amp standards.

#### 2. Noise-Distortion Clearance Range

This is the basic concept for the audio section. The CR-840 offers an extremely wide range of output power level for which both noise and distortion are below the rated value, to ensure a wide dynamic range in actual use.

#### 3. Direct Assessment of Differential Gain

This sophisticated technique enables Yamaha to combine high station-receiving ability, razorsharp tuning, and ultra-low distortion in the tuner section.

#### 4. Optimum Tuning System

The OTS system will take over from you the fine-tuning needed to obtain minimum distortion and maximum stereo separation, so that all FM stereo programs are heard at their best.

#### 5. Twin-Meter FM Tuning with Signal Quality Reading

Both signal strength and center-zero FM tuning meters are provided on the CR-840, with the signal strength meter doubling as a signal quality meter on FM.

#### 6. Comprehensive Tone/Filter Controls

Both bass and treble controls have completely "FLAT" central positions. High and Low filters are also provided.

#### 7. Continuous Loudness Compensation

This Yamaha 'special' fully compensates for the ears' reduced sensitivity to bass and treble frequencies at low listening levels, whatever your normal maximum listening level.

#### 8. Auto DX Circuit for High Quality Reception

The Auto DX Circuit permits the IF range to be automatically modified according to the quality of the broadcast being received, thereby ensuring high sensitivity and high selectivity in reception.

Special Features of the CR-840 Receiver. . . .	2
Cautions—Read this before Operating	
Your CR-840 . . . . .	3
Front Panel and Controls . . . . .	4
Connection Diagram . . . . .	7
Rear Panel and Connections . . . . .	8
Broadcast Reception . . . . .	10
Listening to Records . . . . .	13
LOUDNESS, FILTERS, and	
TONE Controls. . . . .	14
The Special REC OUT Selector Switch . . . . .	15
Tape Playback and Recording . . . . .	16
Specifications . . . . .	18
Trouble Shooting . . . . .	20
Block Diagram . . . . .	22
Schematic Diagram . . . . .	23

#### IMPORTANT!

Please record the serial number of your unit in the space below

Model Name **CR-840**  
Serial No. \_\_\_\_\_

The serial number is located on the rear of the chassis. Retain this Owner's Manual in a safe place for future reference.

# CR-840

## CAUTIONS—READ THIS BEFORE OPERATING YOUR CR-840

1

The CR-840 is a high performance AM/FM stereo receiver, with excellent selectivity, sensitivity, low distortion, and high output power. This manual is required reading if you are to get the best from its special features and controls.

2

Do not drop or otherwise jar the CR-840, which is a precision electronic instrument.

3

Do not place the CR-840 where it will be exposed to direct sunlight, excessive heat (for instance over a radiator), cold, moisture, or dust.

4

Do not use chemical solvents (such as benzene or alcohol) to remove traces of dirt. Wipe only with a soft, slightly damp cloth.

5

The CR-840 is so heavy. When installing, make sure to select a firm and solid base.

6

Do not attempt to carry out internal adjustments or repairs. Leave these to your local authorized service representative.

7

Do not assume your CR-840 is faulty before checking the "Trouble Shooting" list provided on page 20 to 21.

8

Operate all switches and knobs in accordance with the instructions. Avoid applying undue force, which should never be necessary, and do not attempt to use in between switch positions.

9

Do not connect other audio equipment to the spare AC outlet sockets on the rear panel if the equipment will require more power than the outlets are rated to provide.

10

Keep this manual in a safe place for future reference, and refer to it frequently until you are completely familiar with all CR-840 controls and functions.

Warning — to prevent fire or shock hazard, do not expose this appliance to rain or moisture.

# CR-840

## FRONT PANEL AND CONTROLS

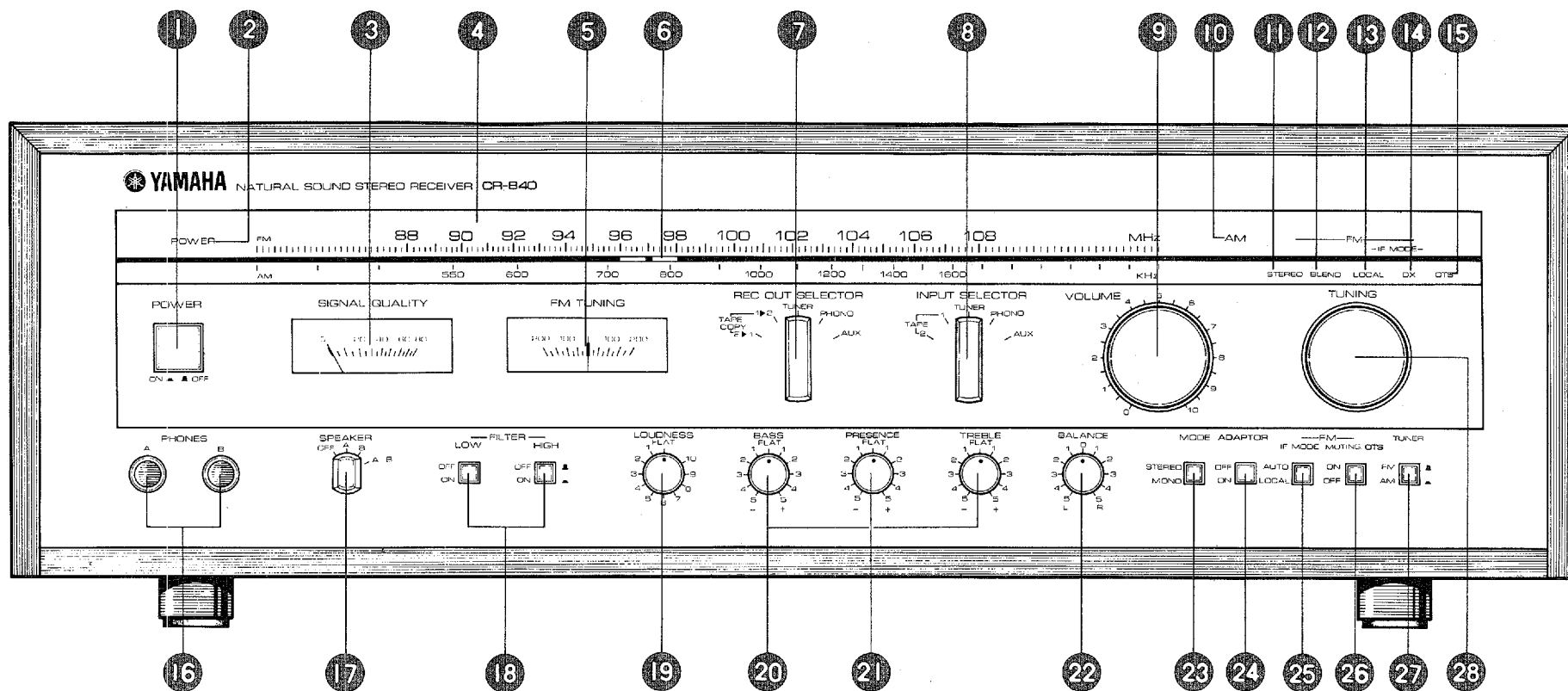

### 1 POWER ON/OFF Switch

Switch ON to activate the main electrical supply. Leave OFF while familiarizing yourself with the controls, and while connecting other audio equipment.

### 2 POWER (Power Indicator)

This light-emitting diode gives visible indication of the Power being ON.

### 3 SIGNAL QUALITY Meter

This meter indicates the signal strength for both AM and FM stations, and also indicates the presence of FM interference by oscillations of the meter indicator, with the amplitude of the indicator fluctuations showing the extent of the interference.

### 4 The FM/AM Tuning Scale

The upper scale gives FM station frequencies in MHz and the lower scale gives AM frequencies in kHz. On the right-hand side of the front panel, the LEDs light to indicate FM or AM operation.

#### Ⓜ FM TUNING Meter

This is used when tuning in FM stations: the indicator points to dead center when the station is perfectly in tune.

#### Ⓜ DIAL POINTER

Turn the tuning knob to align this pointer to a desired station.

#### Ⓜ REC OUT SELECTOR

This selects which program source will be recorded, just as input selector selects which program source will be heard. With the CR-840, you can listen to one program source while recording any other (copy a friend's tape while listening to FM, etc.). This eliminates "dead" time while you are taping, permitting you to enjoy the use of your CR-840 while recording.

#### Ⓜ INPUT SELECTOR

This selector switch is used to select the program source of your choice, whether it be Phono, Tuner, one of two tape decks, or Aux (for use with 8-track tape cartridge playback, etc.). The phono switch position input circuit is designed to operate with normal moving magnet (MM) type cartridges. Use of some moving coil (MC) type cartridges is possible, but, other low output moving coil cartridges may require use of a step-up transformer or a head amplifier.

#### Ⓜ VOLUME Control

Use this control to give the volume of sound that you require. Always start with it turned fully to the left (counter-clockwise) at the "O" position before turning it up to the volume level you require (clockwise).

#### Ⓜ AM (AM Indicator)

This indicator comes on when receiving an AM broadcast.

#### Ⓜ STEREO (Stereo Indicator)

This indicator comes on automatically when FM stereo broadcasting is received and goes out automatically when there is monaural reception.

#### Ⓜ BLEND (Blend Indicator)

This indicator comes on automatically when the signal you receive is weak. In weak reception areas, when a hissing or high pitched noise makes for poor FM stereo reception, the blend circuit will cut in to cancel the high-range noises. It operates when the IF MODE switch is in AUTO (■).

#### Ⓜ LOCAL (Local Indicator)

It lights up during Local (general) reception. When the IF Mode Switch is in Local (■), however, it remains lighted regardless of distant or local reception.

#### Ⓜ DX (DX Indicator)

If the DX indicator light is on when the IF MODE switch is in the Auto (■) position, it signifies that the tuner is operating in the DX MODE. When tuned to a powerful local station, the local mode takes over.

#### Ⓜ OTS (OTS Indicator)

If the OTS indicator light is on when the FM Muting/OTS switch is in the ON (■) position, it signifies that the Optimum Tuning System will correct any slight mis-tuning, to assure optimum reception of FM stations.

#### Ⓜ PHONES A and B jacks

Two headphone jacks are provided. Plugging into the jacks does not cut-off power to the speakers, so it is necessary to use the off position of the speaker selector switch if you do not want the speakers to function.

#### Ⓜ SPEAKER

With this switch you can select either (A or B) or both (A + B) of two sets of stereo speaker systems.

#### Ⓜ LOW and HIGH FILTERS

The low filter gives a sharp 12 dB/octave cut-off below 25Hz. The high filter has 6 dB/octave cut-off slope at frequencies above 8 kHz.

#### ⑩ LOUDNESS Control

This boosts the extreme low and high frequencies to compensate for our ears' reduced sensitivity to these frequencies at low volumes. Set it to the FLAT position while the VOLUME control is set to your normal maximum listening level. Turning it counter-clockwise will reduce the volume while retaining the natural balance between low and high frequencies.

#### ⑪ BASS and TREBLE Controls

The bass and treble controls have a low turnover frequency of 350 Hz and a high turnover frequency of 3.5 kHz respectively. In the flat positions, the tone control circuits' frequency response is completely flat.

#### ⑫ PRESENCE Control

This control, centered about 3 kHz, readily adjusts for mid-range characteristics.

#### ⑬ BALANCE Control

The balance knob controls the difference in output volume between the L and R (left and right) stereo channels. Set this control to the center "O" position, at which there is a click stop, unless you need to correct for a lack of balance between the

audio level of the two channels, or to correct for a listening position which is not equidistant from the two speakers. The balance control reduces the volume from the left-hand speaker when turned clockwise, and reduces that from the right-hand speaker when turned counter-clockwise.

#### ⑭ MODE Switch



This gives the choice of stereo or monaural reproduction. Note that in the mono position the amplifier section will reproduce all sounds (including FM stereo programs, etc.) monaurally.

#### ⑮ ADAPTOR Switch

When connecting a Graphic Equalizer, Dolby Unit or any other audio equipment to Adaptor terminals, set the ADAPTOR switch to ON. Make sure to keep it OFF when not used.

Leave OFF while not connecting any other audio equipment.

#### ⑯ IF MODE Switch

With this switch in Auto (  ), Local (general) function automatically switches to DX (long distance) so please leave the switch in this position for normal use. Switching to Local (  ) position compels the tuner to stay in the Local mode regardless of remote or local signal reception.

#### ⑰ MUTING/OTS Switch

When this switch is in the ON position, the Optimum Tuning System (OTS) will minimize the effect of any mis-tuning, and will ensure continued optimum reception of FM stations. In the OFF position, accurate manual tuning is essential. Even in the ON position, however, OTS is automatically switched off when you touch the tuning knob, permitting manual tuning. The FM muting function ensures that both inter-station noise and weak signal strength stations will be muted. In the OFF position even the weakest stations will be heard.

#### ⑱ TUNER FM/AM Switch

This determines whether AM or FM stations will be received.

#### ⑳ TUNING Knob

The large tuning knob gives smooth and positive station selection, with a precision flywheel mechanism.

# CR-840

## CONNECTION DIAGRAM

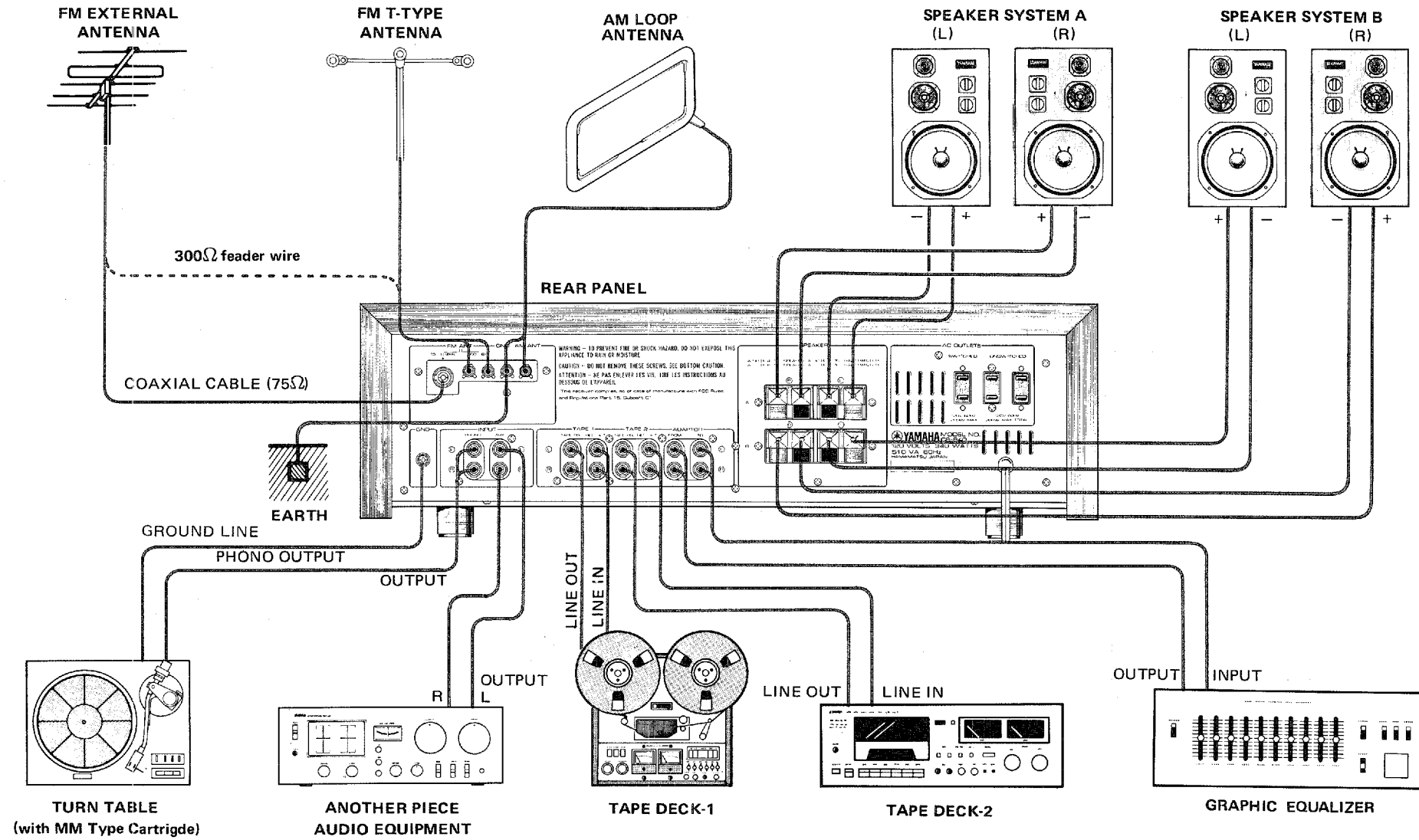

# CR-840

## REAR PANEL AND CONNECTIONS

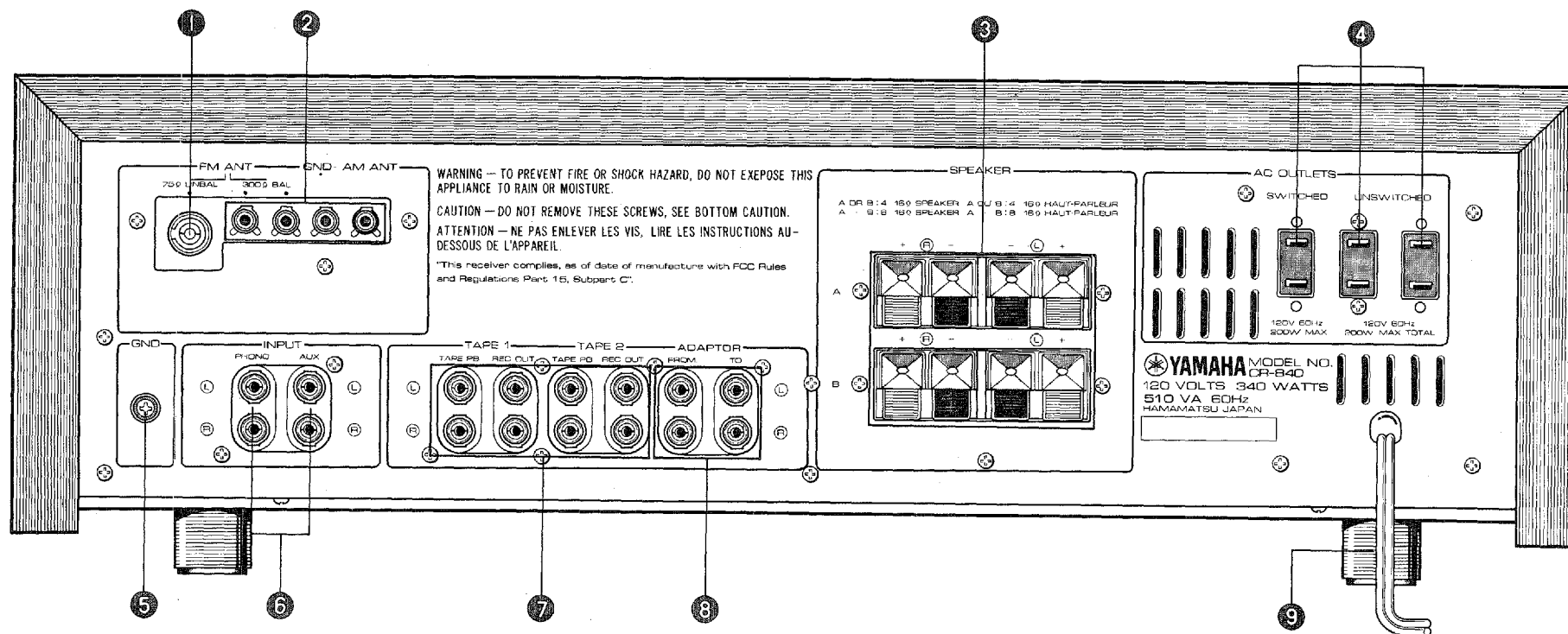

### ① FM ANT 75Ω UNBAL

The 75Ω UNBAL (unbalanced) terminal is used for an unbalanced type 75Ω coaxial cable. (Refer to P10).

### ② Antenna Connections

Detailed instructions on AM and FM reception are given on pages 10 to 12, but a quick check of CR-840 tuner functions can be carried out by connecting the T-type indoor antenna provided with the CR-840 to the terminals marked 300Ω BAL.

Attach the two arms of the "T", fully extended, to the ceiling or walls of your room. The quick check can be carried out with the selector switches vertical and all push button switches in the out (  ) positions, except for the speakers selector switch (when you wish to hear the output on your speakers rather than using headphones).

### ③ SPEAKER

The CR-840 can handle two sets of speakers (A and B), with selection of either, both, or neither, by use of the Speakers Selector switch on the

front panel. Speakers should have impedances between 4 and 16 ohms, but when the two speaker sets are to be used at the same time, connect only speakers with impedances between 8 ohms and 16 ohms. Use speakers rated to take the full 60 watts of output power, or set the volume control so that the rated maximum speaker input power is not exceeded. Volume level should be reduced immediately whenever there is increased distortion or a sense of strain which indicates that the speakers are being overloaded.



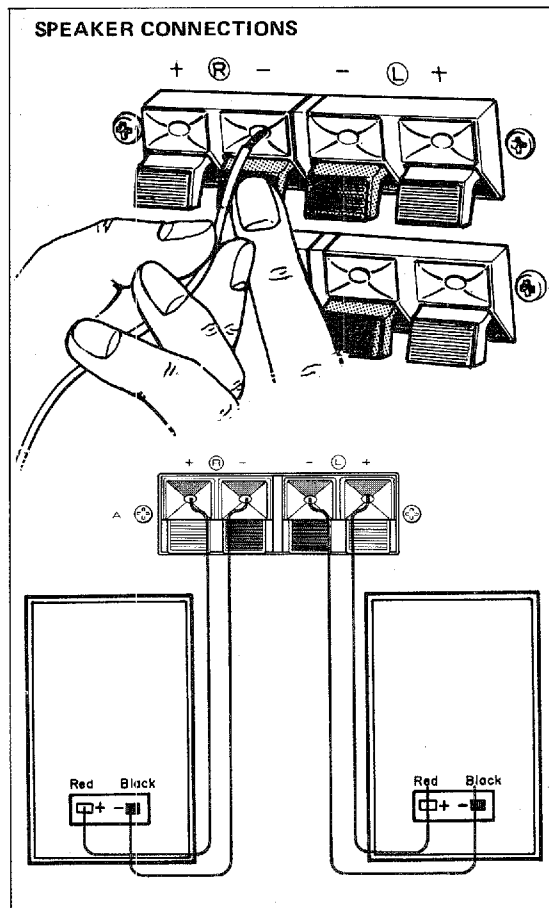

**Making the Speaker Connections**

1. Strip 1/2" of insulation from the speaker cable and twist the stray ends together. If possible solder the ends. Push the lever beneath the terminal as shown in the diagram, and aligning

the inner and outer terminal holes. Then fully insert the stripped wire. Release the lever, and the wire end will be firmly clamped.

2. Use the upper (A) terminals first. Be careful that the terminals identified by the + and - signs above them are connected with the corresponding + and - terminals on the speakers. A mistake will result in poor bass response and ill-defined stereo image. Also be sure to connect the left-hand speaker to the L speaker terminals, and the right-hand to the R terminals.

3. Repeat this with the B terminals if other speakers are to be connected. In all cases make sure that connections are fully and firmly made, or you may not be able to get any sound from one or more speakers.

**AC OUTLETS**

These spare AC Outlets are provided for your convenience in connecting other items of audio equipment. Only the left outlet is controlled by the CR-840 power switch. This has a maximum power rating of 200 watts, and should be used for items such as turntable units. Do not connect any item which draws more than 200 watts. The other outlets are not affected by the CR-840 power switch, and any items connected to them must be switched on and off by their own power switches. Note that the total power available from these two outlets together is only 200 watts. Use them for such items as your tape deck.

**GND (Ground) Terminal**

The ground terminal is provided for grounding turntable units.

**INPUT Terminals**

These are the terminals which are selected by the Input Selector switch on the front panel. They include Phono and Aux connections. The Aux terminals can be used to connect an external tuner, or for an 8-track cartridge tape player, etc.

**TAPE PB and RECOUT Terminals**

Two tape decks can be attached to these input and output terminals. Recording can be made on both tape decks at the same time, of any source connected to the CR-840, by setting the Recout selector switch on the front panel to the appropriate position. Tapes can be dubbed from one deck to the other in either direction, and recording can proceed while any other source selected by the Input selector is being auditioned.

**ADAPTOR Terminals**

When connecting a Graphic Equalizer, Dolby Unit or any other audio equipment to the Adaptor terminals connect its output terminal to the FROM terminals of CR-840 and its input terminal to the TO terminals of the CR-840.

**AC Electrical Power Line**

Plug the CR-840 power cord into a main power supply wall outlet socket, and make sure the line is not likely to be tripped over.

# CR-840

## BROADCAST RECEPTION

### CONNECTING AM/FM ANTENNA

The T-type antenna provided with your CR-840 is adequate only in high signal strength areas and under favorable conditions. In other cases, an external multi-element FM antenna is needed. If you cannot obtain satisfactory reception with the T-type antenna, this is an indication that you need an external FM antenna. To ensure the very best results, a motor-driven antenna assembly with remote control of its orientation is ideal, but the CR-840 has sufficient sensitivity to operate well with a fixed antenna. The external antenna should preferably be located fairly close to the CR-840, and mounted as high as conveniently possible. Try various antenna orientations, either pointing towards the weakest station you intend to receive or away from the major source of interference (preferably both, although some compromise is usually necessary in most locations). If the antenna is intended for use with shielded coaxial cable (which reduces losses and interference) use the  $75\Omega$  UNBAL terminals on the rear panel of the CR-840, and connect the cable as shown. Antennas intended for use with the  $300\Omega$  BAL terminals on the rear panel (which use feeder wire similar to that of the internal antenna provided) can also be used with coaxial cable if a matching transformer is attached to the antenna. The use of coaxial cable is advisable where the antenna must be located some distance from the CR-840, or where interference from automobile ignition, etc., is troublesome.

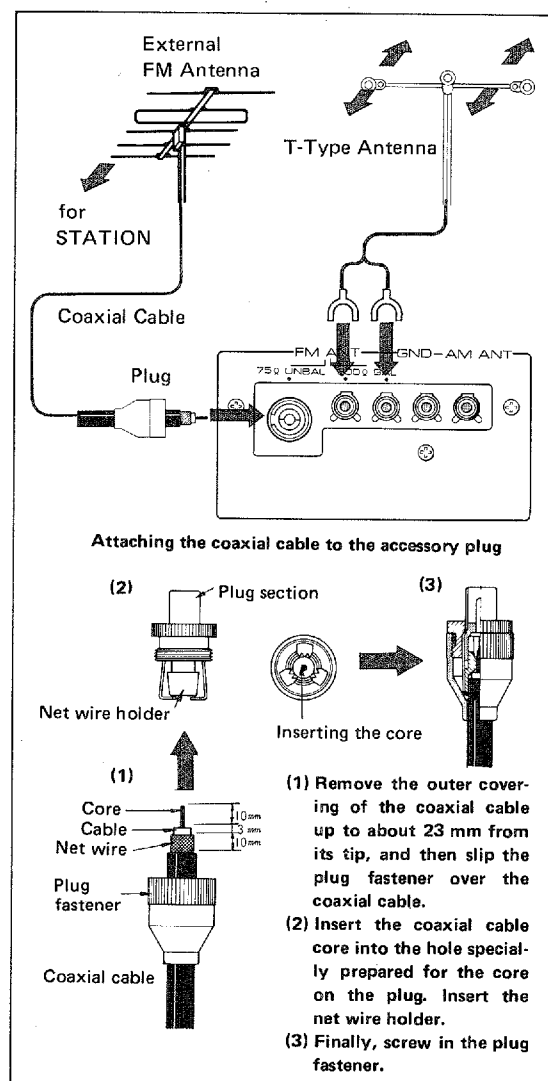

Fig. 1

### FM BROADCAST RECEPTION

1. Set the INPUT SELECTOR to TUNER.
2. Set the TUNER push-button to FM.
3. Check that the FM indicator LEDs light at the right-hand side of the dial.
4. All switches and knobs should be as shown in the front-panel diagram.
5. Tune for maximum signal strength on the SIGNAL QUALITY meter, ignoring any oscillations of the indicating pointer position.
6. Now tune to bring the FM TUNING meter pointer to its exact center. This is the optimum tuning position: set it carefully.
7. Check that the FM stereo indicating LED lights if you intend listening to a stereo rather than a monaural broadcast.

When connecting the coaxial cable to the  $75\Omega$  UNBAL connector which is located on the rear panel of the CR-840, first attach the cable to the accessory plug as shown in the figure, and then connect.

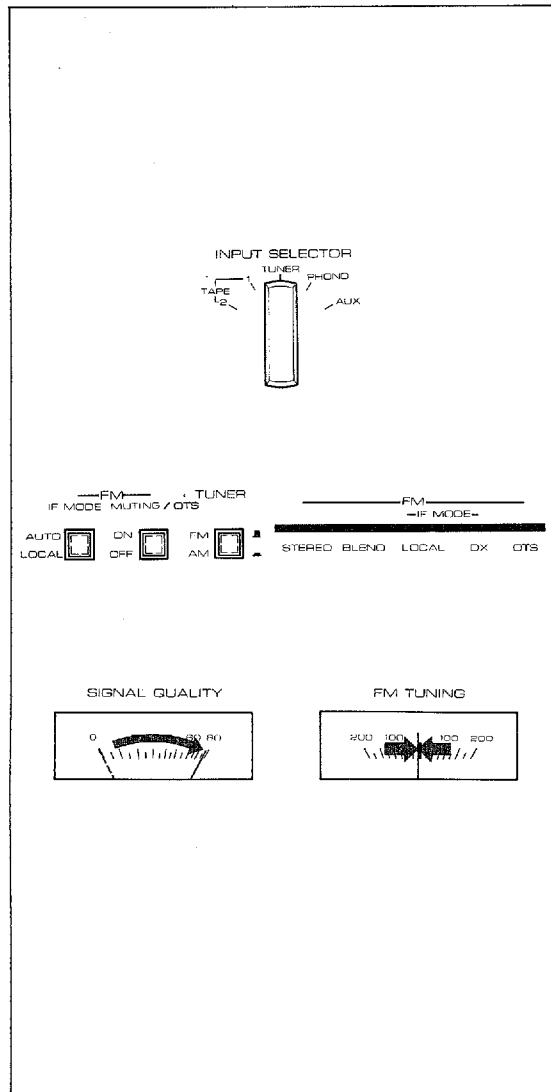

Fig. 2

### FM MUTING/OTS SWITCH

This push-button switch should normally be left in the ON position. If pushed into the OFF position, it will over-ride the OTS circuits, allowing full manual tuning, but preventing the automatic correction of slight mis-tuning and of drift due to the influence of temperature and humidity. Switch OFF for reception of weak stations near powerful local stations which might be 'pulled in' by the OTS. If you decide that the weakest stations cannot give you sufficient listening enjoyment, leave this control in the FM MUTING/OTS ON position. The weakest stations will be cut out, along with the interstation noise. You will be able to tune from station to station, sure of good quality reception, free of background noise and remote, very poor quality stations.

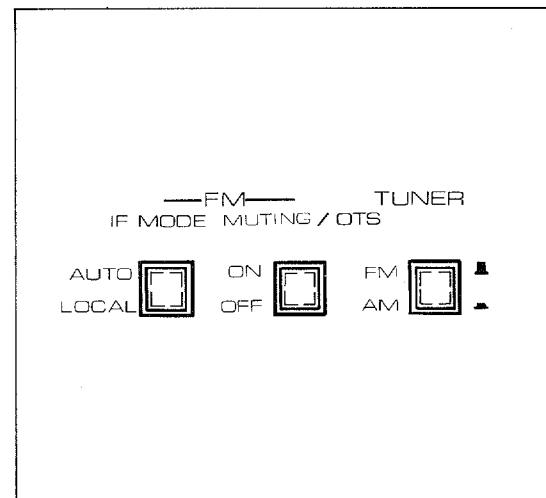

Fig. 3

### SIGNAL QUALITY METER

The SIGNAL QUALITY meter, as well as giving a reading for the signal strength of AM and FM station signals, also gives a visual indication of FM signal quality. When so-called 'multipath' (waves reflected from nearby hills or tall buildings) are present, the meter pointer will oscillate, centering on the average value of the signal strength. If you notice such variations in the SIGNAL QUALITY meter readings, try different antenna orientations. You will generally enjoy better tonal quality if you orient the antenna to give a steady reading, even if this level is a little lower than the maximum when the indication is fluctuating.

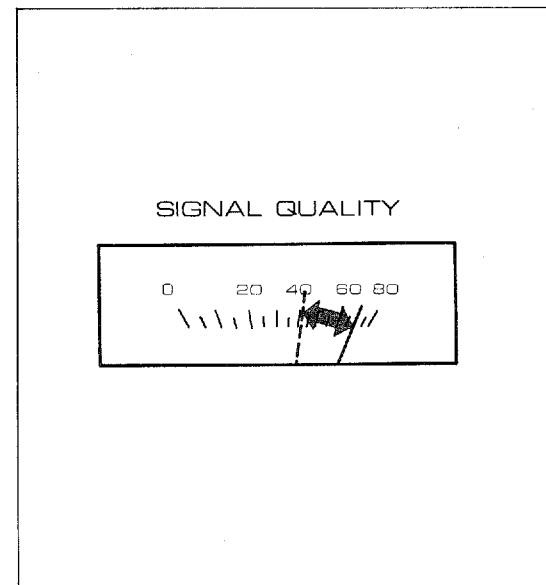

Fig. 4

## MULTIPATH DETECTION

FM multipath is somewhat like the TV "ghost" phenomenon. As shown in Fig.5, some FM signals are received directly by the antenna while others reach it from many directions, bouncing off buildings or mountains. The latter are called multipath waves. These are received slightly later than the direct waves, and this causes some sound distortion and deterioration in separation and tonal quality. This multipath effect can be minimized by using a tall antenna with good directional characteristics and by careful orientation so as to eliminate interference.

During FM reception, a delicate quiver of the signal meter indicator indicates multipath interference. Change your antenna orientation or position so that the indicator stabilizes.

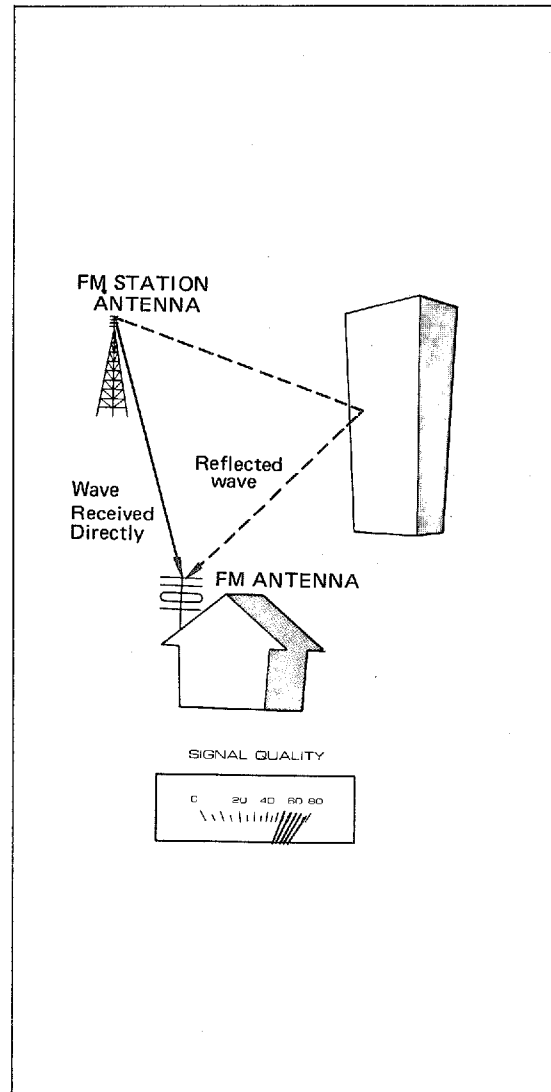

Fig. 5

### CONNECTING THE LOOP ANTENNA

Connect the cord from the loop antenna to the ANTENNA AM and GND terminals on the rear panel of the receiver. If the combination bar is not removed, best reception will not be obtained.

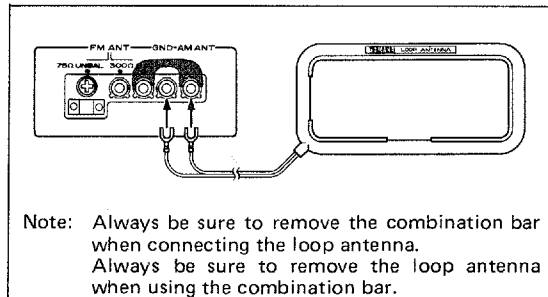

Fig. 9

### USING THE LOOP ANTENNA

Adjust the direction of the loop antenna for best reception as shown in the Fig. 10.

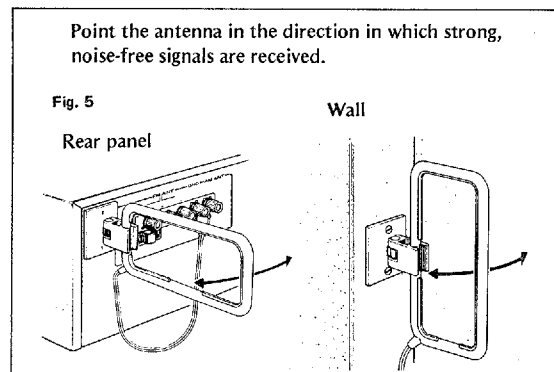

Fig. 10

Since the AM broadcast frequency band is a low 500 kHz ~ 1,600 kHz, its wavelength is approximately 300m at 1,000 kHz and the use of a long antenna is ideal for noise-free reception. However, an FM antenna is actually used as an AM antenna and AM broadcasts are received at an extremely low input level.

Therefore, satisfactory reception may be impossible where AM receiving conditions are poor (such

as inside a building and near fluorescent lamps, thermostats, motors, or discharge lamps).

Use this loop antenna by referring to the following table.

This loop antenna is designed to be used vertically. If used otherwise, its reception sensitivity reduce expensively. So, please do not fail to use it vertically all the time.

### Conditions and Symptoms when receiving AM broadcasts with the Loop Antenna

Receiving Conditions – What antenna are you using in what room?		Symptom – What are the receiving conditions of the AM broadcast you want to receive?
Room	Antenna	
Inside Building	T-type FM antenna	AM broadcasts cannot be received.
Inside Building and near Noise sources. ※	T-type FM antenna	Very Noisy (Signal meter pointer deflects only slightly.)
Not inside Building, but near Noise sources. ※	T-type FM antenna (with lead wire extension)	Very Noisy (Signal meter pointer deflects only slightly.)
In a room near a power line.	T-type FM antenna	Modulation hum is loud.
Near a high tension line.	Outdoor antenna or Community antenna	
Broadcast station signal is strong, but antenna is near indoor wiring and Noise sources. ※	T-type FM antenna, Outdoor antenna, or Community antenna	Interference.

※ **Noise sources:** Fluorescent lamps, thermostats, motors, discharge lamps, and other electrical devices.

※ Under the conditions except the above figure, use the combination bar.

## AM RECEPTION

First set the TUNER FM/AM switch to AM, and set the tuning indicator to the desired station frequency. Adjust the tuning knob to give the maximum SIGNAL meter reading. Note that the FM TUNING meter does not function for AM stations.

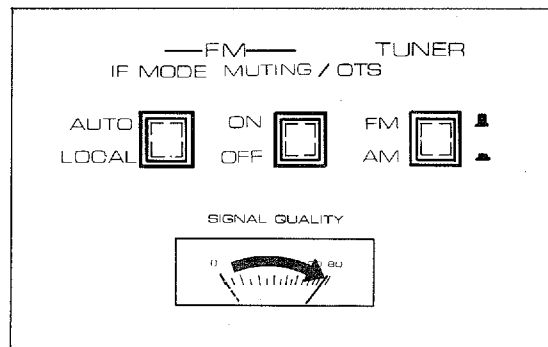

Fig. 6

Your Yamaha Loop Antenna is a special, low-noise antenna for AM broadcasts. Always be sure to connect it to your receiver. Otherwise, AM broadcasts may not be received.

If the FM antenna is used for an AM antenna, install the combination bar as in Fig. 9.

## INSTALLATION

### 1. Installation position

This antenna can be mounted to the rear panel of a receiver, rear of a rack, or on a wall. Install it as far away from noise sources as possible.

### 2. Installation method

Peel the seal off the rear of the antenna holder, position the adhesive side of the holder at the position you wish to install it, and push the holder against the panel, wall, or rack firmly.

Note: Since the adhesive is extremely strong, be sure to position the holder correctly before mounting it securely.

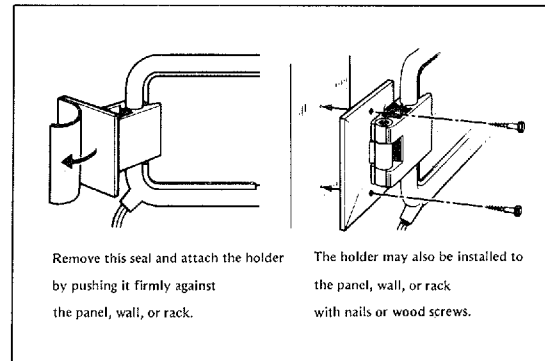

Fig. 7

### 3. Loop antenna

The loop antenna can be detached from the holder and reinstalled by either of the two methods illustrated in the Fig. 8. Use the method which provides the best reception.

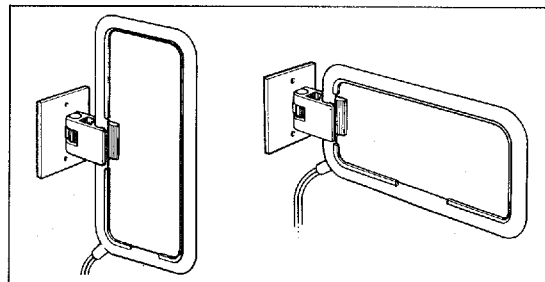

Fig. 8

# CR-840

## LISTENING TO RECORDS

### CONNECTING A TURNTABLE

The main AC supply plug of your turntable unit may be inserted into the spare AC outlet socket controlled by the CR-840 POWER switch. With some turntables it is important not to disconnect the main supply without first switching off the turntable itself (read your turntable instruction manual to check). In this case you should use one of the two unswitched spare AC outlets. The pin plugs on the output lead from the turntable unit should be connected to the PHONO terminal pin jacks at the left-hand side of the rear panel. Check that the L and R pin plugs (for the left and right channels) have been correctly insert-

ed. Do not forget to connect the turntable ground line to the GND terminal on the CR-840 rear panel.

Switch on the receiver POWER switch and set the INPUT SELECTOR switch to PHONO. The PHONO input circuit is intended for use with standard moving magnet (MM), moving iron (MI) or induced magnet (IM) cartridges. Certain moving coil (MC) cartridges can also be used, but some have output levels too low for satisfactory performance without the use of a step-up transformer or head amplifier. Note that the PHONO input pin-plugs should never be connected or disconnected while the POWER switch is ON.

Always switch off your speakers by switching the SPEAKER switch to the OFF when raising or lowering the cartridge stylus over the record to prevent overloading and possible damage.

If you play monaural records, the signal-to-noise ratio will be improved if you push the MODE switch to the MONO position.

If you notice a low-pitched rumble when playing records, cut this out with the LOW filter. Similarly you can use the HIGH filter to reduce unpleasant surface noise or record 'scratch'. Use the BASS and TREBLE controls to give the best tonal balance, and use the LOUDNESS control rather than the main VOLUME control to reduce listening levels below your normal maximum.

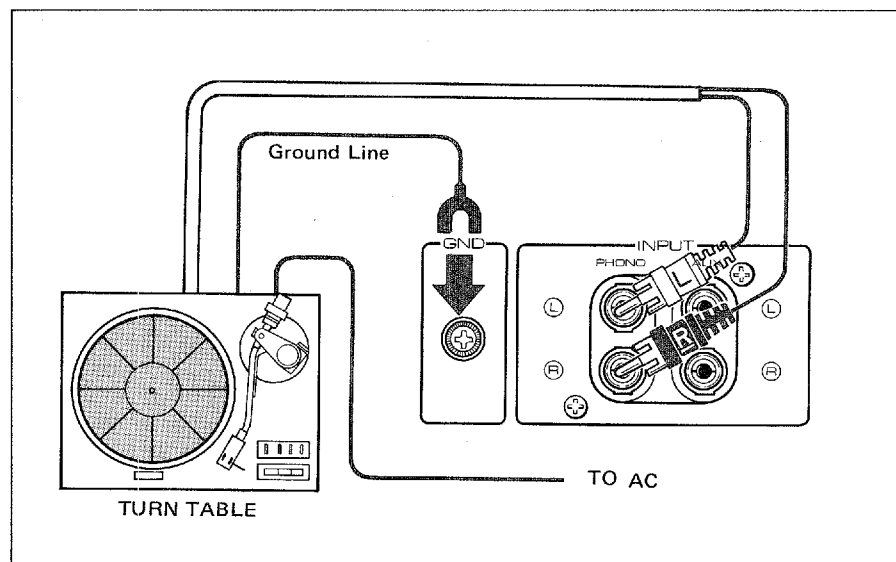

Fig. 11

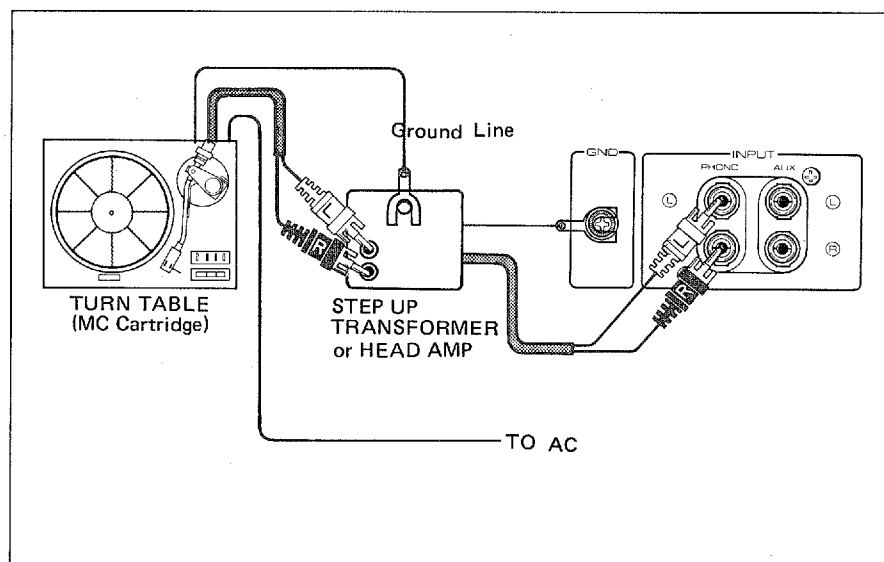

Fig. 12

# CR-840

## LOUDNESS, FILTERS AND TONE CONTROLS

**CAUTION:** Click noise may be heard when rotating Bass volume somewhere about the center of the controls but this is of no trouble.

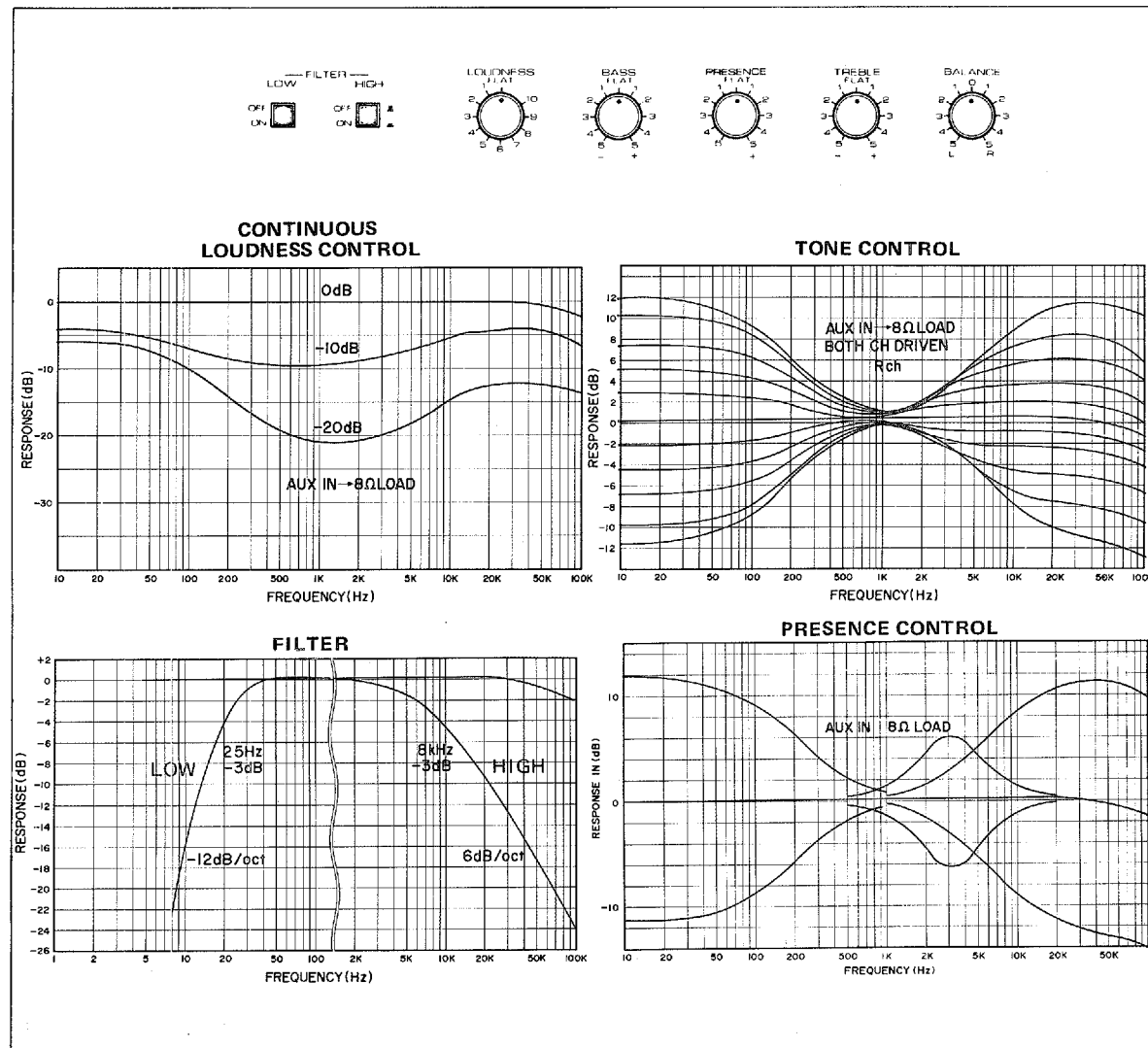

Fig. 13

### CONTINUOUS LOUDNESS CONTROL

Set this to the FLAT position for listening at normal maximum levels. The LOUDNESS compensation circuitry enables the same subjective tonal balance to be retained at lower listening levels as this control is turned down.

### LOW AND HIGH FILTERS

Sharp 12 dB/octave (LOW) and 6 dB/oct (HIGH) cut-offs and low distortion ensure minimum tonal degradation in the important frequencies which carry most of the musical signal. These filters effectively remove sub-sonic rumble and high frequency tape hiss or record surface noise.

### COMPREHENSIVE TONE CONTROLS

The carefully chosen turnover frequencies of the bass and treble tone controls have optimum influence at the higher and lower frequencies for major correction of tonal character. The FLAT position for each control functions as a DEFEAT position, with completely flat response.

### PRESENCE CONTROL

The presence control, centered about 3 kHz, readily adjusts for mid-range characteristics.



# CR-840

## THE SPECIAL REC OUT SELECTOR SWITCH

### INDEPENDENT AUDITION AND RECORDING

Do not confuse the REC OUT SELECTOR and INPUT SELECTOR switches. The INPUT SELECTOR switch decides which program source you hear. The REC OUT SELECTOR switch decides which one you record. Yamaha receivers are at present unique in offering independent choice of audition and recording. Thus you can listen to a record while tape recording direct from the AM/FM tuner section, or while dubbing from one tape recorder to another (set the INPUT switch to PHONO and the REC OUT to TUNER, TAPE 1  $\blacktriangleright$  2, or TAPE 2  $\blacktriangleright$  1 positions). Alternatively, you can tape record a disc while listening to a FM broadcast or a music tape played back on a second tape deck (but be careful that you do not infringe copyright laws by tape recording proprietary material). Just set the REC OUT switch to PHONO and the INPUT switch to TUNER or TAPE 1 (or 2), respectively.

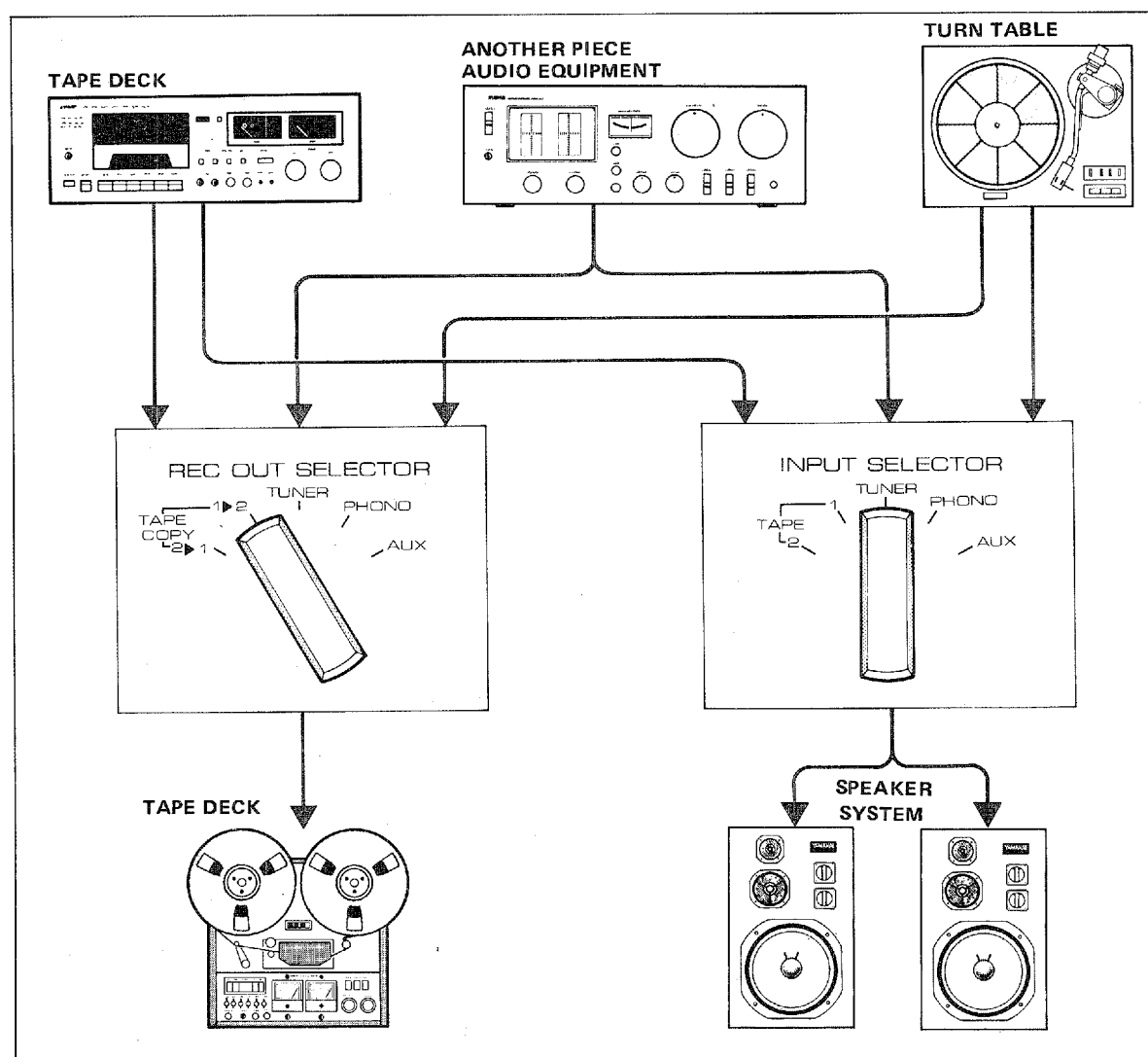

Fig. 14

# CR-840

## TAPE PLAYBACK AND RECORDING

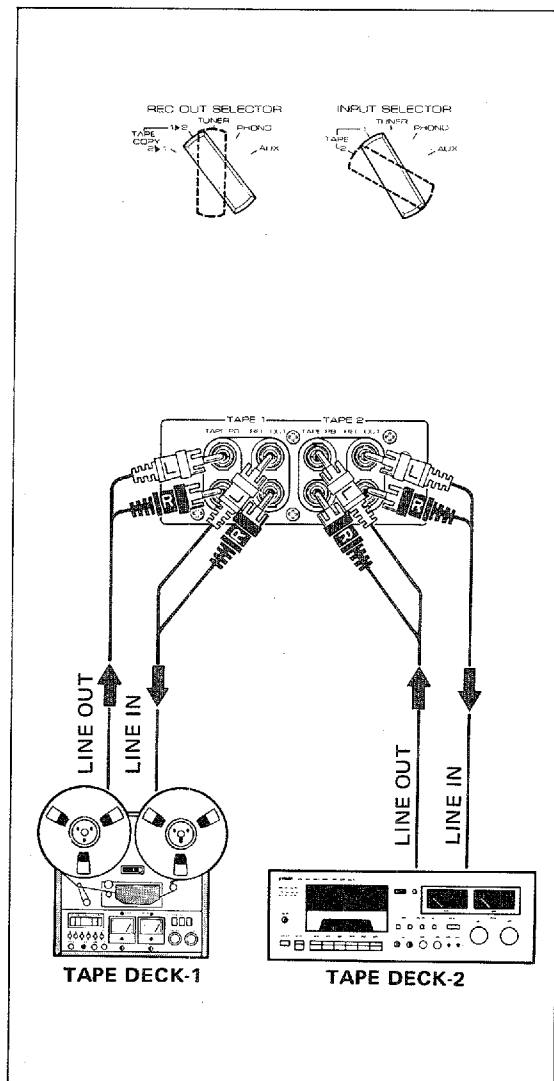

Fig. 15

### TAPE DECK CONNECTIONS/PLAYBACK

The output leads provided with the tape deck are used to connect the tape deck LINE output terminals to the TAPE PB terminals on the rear panel of the CR-840. Use the TAPE 1 terminals for your main tape deck. Use the TAPE 2 terminals for a second tape deck or as a spare pair. Set the INPUT SELECTOR to TAPE 1 to play back tapes (or to TAPE 2 if you are using the TAPE 2 terminals). Use the output level controls on the tape deck or decks to adjust the playback level so that there is no great change in volume level when switching between TUNER and TAPE 1 or 2 terminals.

### TAPE DECK CONNECTIONS/RECORDING

The tape-deck leads provided are used to connect the deck LINE input terminals to the REC OUT terminals on the rear panel of the CR-840. Again, you should use the TAPE 1 terminals for your main tape deck, keeping the TAPE 2 terminals for a second tape deck or as a spare pair.

Note that the INPUT SELECTOR switch setting has no effect whatever upon the signal which will be recorded via these TAPE terminals. The REC OUT terminals' output signal is decided by the

REC OUT selector switch. If you refer to the description of the REC OUT function on the previous page you will see that the recording of any of the program sources connected to the CR-840 is possible: just set the REC OUT switch to TUNER, PHONO, or AUX, as you wish.

Recording of any of these sources can proceed while that source, or any other, is selected for audition by the INPUT SELECTOR switch. Monitoring of the recording while it is in progress can also be carried out if you are using a three head deck designed for monitoring. Just set the INPUT SELECTOR switch to the TAPE position (1 or 2).

(Note: most cassette tape decks have only two heads, and monitoring is impossible; most open reel decks do have three heads, with one used for monitoring.)

The level at which a tape recording is made is very important: for full details of recording techniques you should consult the instruction manual provided with your tape deck. Adjustments in level must be made with the input level controls on the tape deck. Note that the signals from the REC OUT terminals which are recorded by your a tape deck are not influenced at all by settings of the tone, filter, and volume controls, etc., on the front panel of the CR-840, and all such tonal and other adjustments must be made on playback. If you record at too low a level you will notice a high level of tape 'hiss' on playback, and if the level is too high, the peak volume levels will be distorted and you may even have difficulty in erasing them later.

## TAPE TO TAPE DUBBING

For tape-to-tape dubbing, you will need two decks. Make the connections to the PB and REC OUT terminals for TAPE 1 and TAPE 2 as explained above. If there is a difference in the quality of the decks, the best results will often be obtained if the better deck is used for the recording rather than for the playback. Check by making brief recordings in both directions and comparing the resulting quality of playback.

Check carefully that the L (left) and R (right) channel pin-jacks have been correctly connected before commencing to dub. To copy a tape from the TAPE 1 to the TAPE 2 terminals, use the TAPE 1 ▶ 2 setting on the REC OUT selector switch. Similarly, to copy from the TAPE 2 to the TAPE 1 terminals, use the TAPE 2 ▶ 1 setting. In both cases you can compare the original recording and the copy by switching the INPUT SELECTOR between the TAPE 1 and TAPE 2 settings (provided that you have decks which allow you to monitor). Once you are satisfied that the recording is proceeding satisfactorily, you can turn the INPUT SELECTOR switch to any other program source you wish to enjoy, and the recording will not be affected. If one or both of the tape decks are not provided with an automatic shut-off function, you should watch carefully for the end of the tape in order to prevent strain on the drive mechanism and capstan assembly.

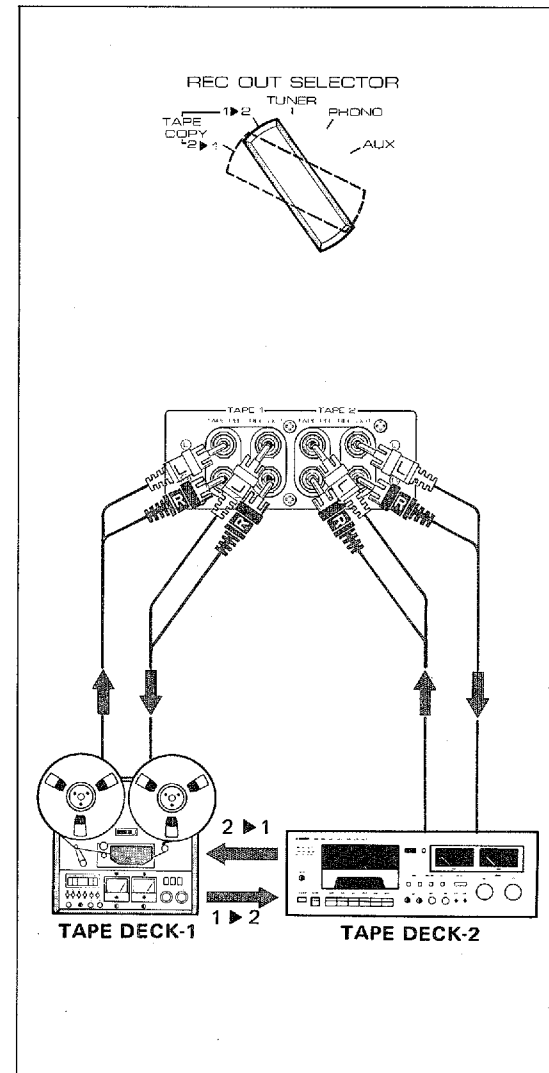

Fig. 16

## CONNECTING AUDIO EQUIPMENTS

When using a Graphic Equalizer to equalize input and recording program output, Dolby Unit, or any other audio equipment, connect it as shown in the figure below and set the ADAPTOR switch on the front panel to ON.

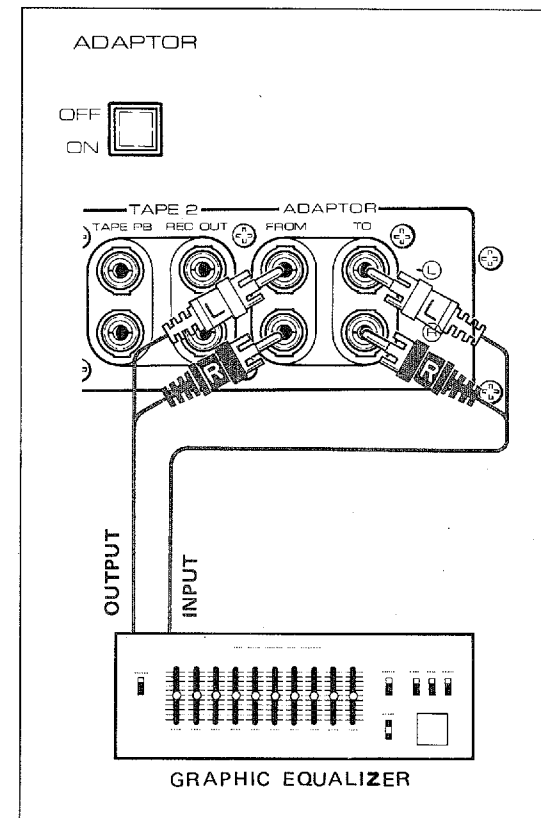

Fig. 17

# CR-840

## SPECIFICATIONS

### AUDIO SECTION

#### Minimum RMS Output Power per Channel

65 Watts (4 ohms) from 20 to 20,000 Hz at no more than 0.02% Total Harmonic Distortion.  
60 Watts (8 ohms) from 20 to 20,000 Hz at no more than 0.02% Total Harmonic Distortion.

**Continuous RMS Power** 75 Watts (4  $\Omega$ )  
(both channels driven, 1 kHz) 65 Watts (8  $\Omega$ )

#### Input Sensitivity/Impedance

Phono 2.5 mV/47 k $\Omega$   
Aux, Tape 1, 2 120 mV/40 k $\Omega$

#### Maximum Input Levels

Phono 140 mV at 1 kHz

#### Output Level/Impedance

Rec Out terminals (Phono) 120 mV/220  $\Omega$ (rated)  
(Aux Tape) 120 mV/5 k $\Omega$

#### Frequency Response

Phono RIAA deviation 0.4 dB  
Aux, Tape 1, 2 to SP Out 20 Hz to 20 kHz  $\pm$ 0.3 dB

#### Tone Control Characteristics

Bass turnover frequency 350 Hz  
Bass boost/cut  $\pm$  10 dB at 50 Hz  
Presence center frequency 3 kHz  
Presence boost/cut  $\pm$  6 dB  
Treble turnover frequency 3.5 kHz  
Treble boost/cut  $\pm$  10 dB at 20 kHz

#### Filters and Loudness Control Characteristics

Low 25 Hz (12 dB/octave)  
High 8 kHz (6 dB/octave)  
Loudness control Level-related equalization

### Signal-to-Noise Ratio (IHF-A Network)

Phono 94 dB (INPUT shorted)  
Aux, Tape 1, 2 100 dB  
Residual noise 0.17 mV

### Distortion 20 Hz to 20 kHz

Phono to Rec Out 0.02% 1V output  
Aux, Tape to Sp Out (8  $\Omega$ ) 0.01% at 30 W

**Noise-Distortion Clearance Range (NDCR) for 0.1% into 8  $\Omega$  at 1 kHz**  
From 10 mW to 60 Watts with Vol -20 dB (Phono Input to SP out)

**Power Bandwidth (IHF)** 10 Hz to 40 kHz

**Damping Factor (at 1 kHz)** Better than 40 into 8  $\Omega$

### FM SECTION

**Tuning Range** 87.6 to 108 MHz

#### Usable Sensitivity

300  $\Omega$  9.3 dBf/1.6  $\mu$ V  
75  $\Omega$  9.3 dBf/0.8  $\mu$ V

#### 50 dB Quieting Sensitivity

Mono 15.3 dBf (3.2  $\mu$ V)  
Stereo 37.3 dBf (40  $\mu$ V)

**Image Response Ratio (98 MHz)** 80 dB

**IF Response Ratio (98 MHz)** 100 dB

**Spurious Response Ratio (98 MHz)** 100 dB

**AM Suppression Ratio (IHF)** 60 dB

**Capture Ratio** 1.5 dB

**Alternate Channel Selectivity** DX 82 dB (IHF)  
LOCAL 48 dB (IHF)

#### Signal-to-Noise Ratio (at 65 dBf)

Mono 84 dB (IHF)  
Stereo 80 dB (IHF)

<b>Distortion (at 65 dBf)</b>	
Mono 100 Hz	0.1%
1 kHz	0.08%
6 kHz	0.15%
Stereo 100 Hz	0.1%
1 kHz	0.1%
6 kHz	0.2%
<b>Intermodulation Distortion (IHF)</b>	
Mono	0.08%
Stereo	0.08%
<b>Sub-Carrier Product Ratio</b>	60 dB
<b>Stereo Separation</b>	
50 Hz	45 dB
1 kHz	50 dB
10 kHz	45 dB
Blend	10 dB
<b>Frequency Response</b>	
50 Hz to 10 kHz	± 0.4 dB
30 Hz to 16 kHz	+ 0.4 -1.0 dB
<b>Muting Threshold</b>	19.2 dBf (5 $\mu$ V)
<b>Auto DX Sensitivity</b>	36.1 dBf (35 $\mu$ V) or at 50 dB S/N
<b>AM SECTION</b>	
<b>Tuning Range</b>	525 to 1,605 kHz
<b>Usable Sensitivity (IHF)</b>	15 $\mu$ V
<b>Selectivity (1,000 kHz)</b>	30 dB
<b>Signal-to-Noise Ratio</b>	50 dB (at 80 dB/m)
<b>Image Response Ratio (1,000 kHz)</b>	40 dB
<b>IF Response Ratio (1,000 kHz)</b>	35 dB
<b>Spurious Response Ratio (1,000 kHz)</b>	60 dB
<b>Total Harmonic Distortion</b>	0.4%

<b>Tuner Section Output Level/Impedance</b>	
FM (100% mod. at Rec Out)	450 mV/3.9 k $\Omega$
AM (30% mod. at Rec Out)	150 mV/3.9 k $\Omega$
<b>GENERAL</b>	
<b>Semiconductors</b>	47 Transistors, 9 ICs, 1 FET, 14 Diodes, 3 Zener Diodes, 7 LEDs, 5 Ceramic Filters
<b>Power supplies</b>	AC120 V, 60 Hz
<b>Power Consumption</b>	340 W (Canadian 510 VA)
<b>Dimensions (W x H x D)</b>	510 x 167 x 386 mm (20" x 6-9/16" x 15-1/4")
<b>Weight</b>	13.6 kg (30 lbs.)

Specifications subject to change without notice.

# CR-840

## TROUBLE SHOOTING

Before assuming that your CR-840 is faulty, check this double-sided trouble-shooting list. It details many steps you can take yourself without having to call a service representative. Keep it near your CR-840 for ready reference.

### TUNER SECTION

Fault	Cause	Cure
A persistent hum occurs when an AM station is tuned.	This hum can affect whole areas where broadcast conditions are unfavorable.	Sometimes changing the position of the CR-840 will give an improvement.
Intermittent crackling or continuous background 'roaring' on AM.	Atmospheric electricity or electrical storms, possibly fluorescent lighting or other electrical equipment.	Difficult to eliminate, an external antenna and good ground connection will give considerable improvement.
High pitched whistles, etc., particularly at night on AM.	Signals from adjacent stations are interfering with reception.  The CR-840 is being operated too near a TV set.	Nothing can be done to cut out this interference completely but try the HIGH filter.  Increase the separation between the TV and the CR-840.
The desired station cannot be received at the correct frequency on the dial.	The station strength may be low, and the MUTING circuit may therefore prevent audition.	Switch the MUTING/OTS from ON to OFF.
A stereo station is heard monaurally.	The MODE switch is set to MONO.	Push and release to the STEREO position.
Occasional crackling interference (particularly with remote, weak signal stations).	Electrical noise from automobiles, etc., or from other electrical equipment.	Set up an external FM antenna, as high and as far from the road as convenient: use coaxial cable. Fit an interference suppressor to the offending item where possible.
Disturbing levels of 'hiss' noise when on FM stereo stations.	FM stereo broadcasts are inherently more liable to this at remote, low signal strength locations.	Set up an external FM antenna; if you are already using one, orient it towards the station or replace with a more sensitive array.  Alternatively or additionally, listen with the MUTING/OTS switch set at OFF.
Local stations suffer from unclear, distorted sound.	Signal input from the antenna for these stations is too strong.	Connect an attenuator between the FM antenna and the CR-840, or turn the antenna away from the strongest (closest) station.
During stereo test transmissions, sounds which should come from only one channel can be heard faintly over the other.	This is known as crosstalk, and normally occurs to some extent.	Provided the sound level is very faint compared with the normal level for that channel, no fault is indicated.

## AUDIO SECTION

Fault	Cause	Cure
No power although POWER switch in ON (POWER LED unlit).	AC power line not plugged-in to supply socket. AC main fuse has blown.	Plug firmly into the supply socket. Contact your service representative for a replacement.
No sound although power LED lights.	Volume too low. ADAPTOR switch is in the ON position but no audio equipments are connected to the ADAPTOR terminals, INPUT SELECTOR in wrong position. Input pin plugs incorrectly inserted, loose, or disconnected. Speaker connections faulty. SPEAKER switch is set to OFF.	Turn up volume. Check and change as necessary. Check and insert fully in the correct position. Check and make good. TURN to the A, B, or A + B position.
Sound comes only, or mainly, from either L or R speaker.	Speaker connections faulty. Input connections faulty. BALANCE control not properly adjusted.	Check and make good. Check and make good. Set to give correct stereo balance.
Sound suddenly ceases.	The protective circuit has gone into operation.	Check for incorrect (too low) speaker impedance or short circuits and correct. If the fault persists, switch off and wait briefly before switching on again.
Poor bass response and badly defined stereo image.	Speaker + and – connections are incorrect.	Reverse the connections to one speaker, not both.
A loud 'hum' is heard with, or instead of, the record when attempting PHONO audition.	Either the pin-plugs from the phono cartridge are not firmly plugged into the input sockets, or the braided shielding wire is defective.	Plug in firmly, replacing the defective shielding if necessary. Check and make good the GND (ground) wire connection.
The volume control cannot be raised during record audition without a loud 'booming' noise.	This is caused by feedback of sound from the speakers to the phono cartridge stylus, and is called acoustic feedback.	Increase the separation between turntable and speakers, avoiding locations directly in line with the speakers.
Bass and treble frequencies are unnaturally exaggerated.	The LOUDNESS control is set too low.	Turn to the FLAT position (fully clockwise) and reset main volume and LOUDNESS controls according to the instructions.
Your tape recorder does not record the program you are monitoring.	The REC OUT selector is not set to the required program source.	Turn to the required setting.

# CR-840

## BLOCK DIAGRAM

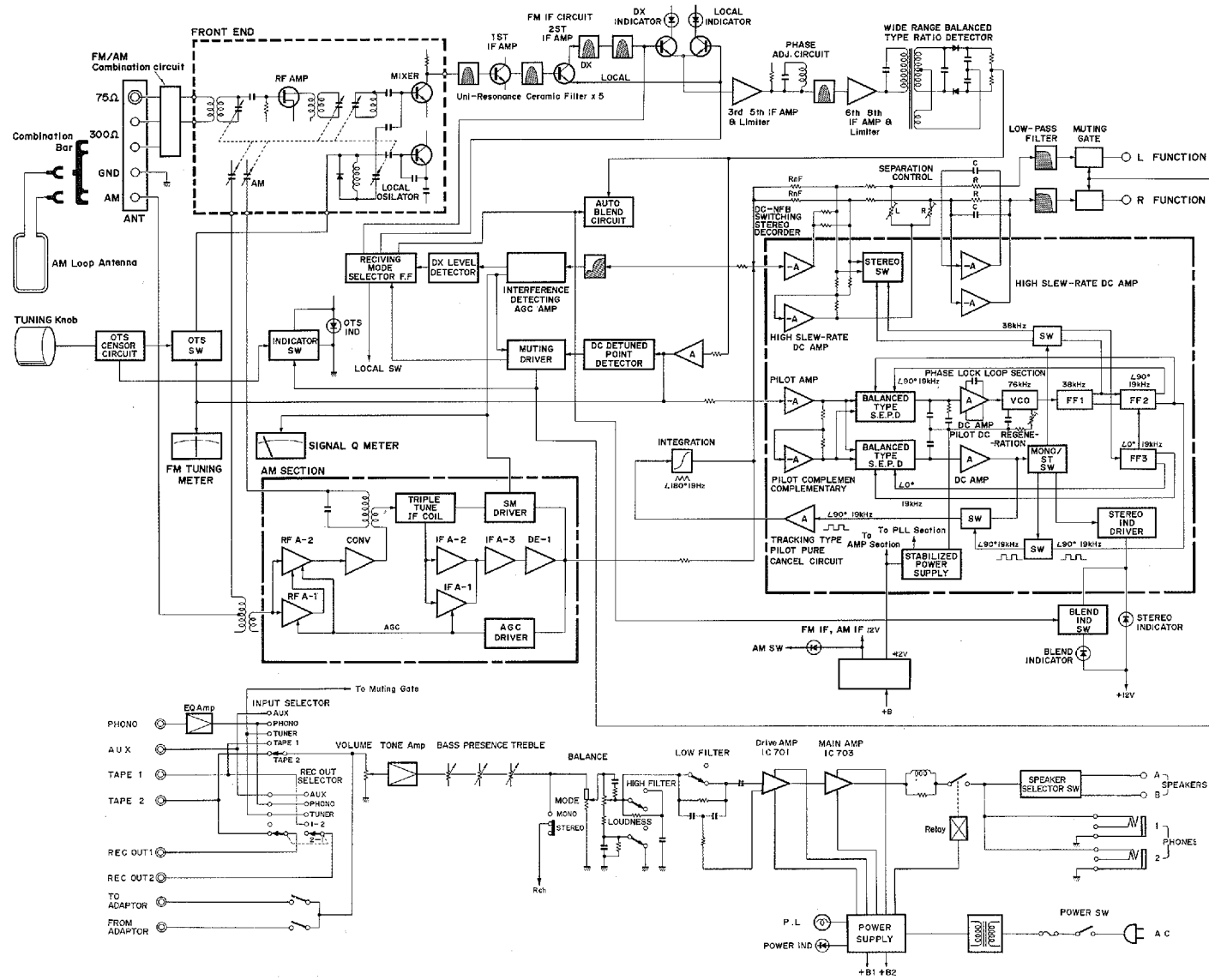



# SCHEMATIC DIAGRAM

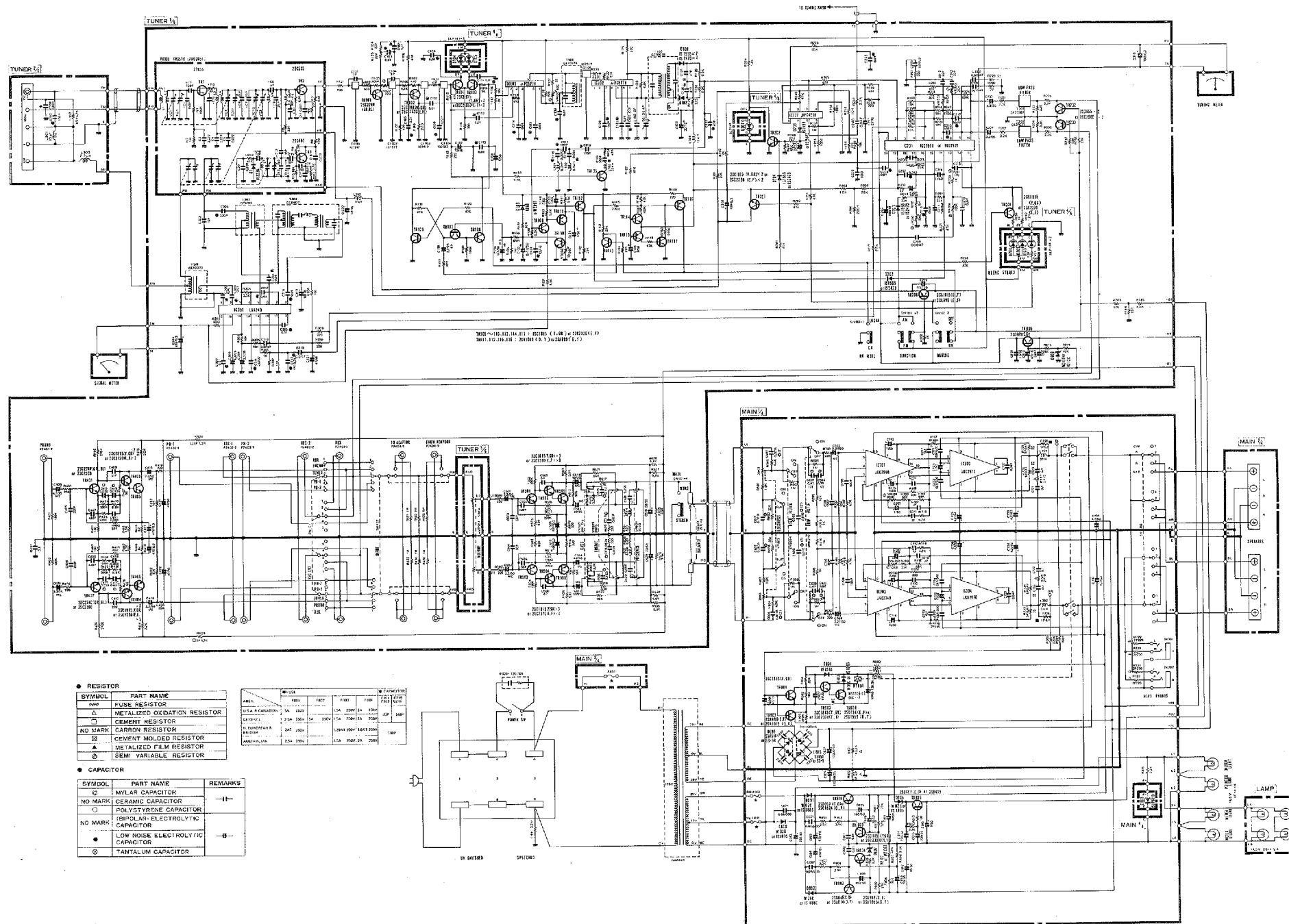

● RESISTOR

SYMBOL	PART NAME
□	FUSE RESISTOR
△	METALIZED OXIDATION RESISTOR
□	CEMENT RESISTOR
NO MARK	CARBON RESISTOR
□	CEMENT MOLDED RESISTOR
▲	METALIZED FILM RESISTOR
⊖	SEMI-VARIABLE RESISTOR

● CAPACITOR

SYMBOL	PART NAME	REMARKS
□	MYLAR CAPACITOR	
NO MARK	CERAMIC CAPACITOR	—  —
NO MARK	POLYSTYRENE CAPACITOR	
NO MARK	BIPOLAR-ELECTROLYTIC CAPACITOR	
●	LOW NOISE ELECTROLYTIC CAPACITOR	—  —
⊖	TANTALUM CAPACITOR	

SINCE 1887  **YAMAHA**  
NIPPON GAKKI CO., LTD. HAMAMATSU, JAPAN

