



# *RX-V661*

---

*AV Receiver*

OWNER'S MANUAL

# Important safety instructions

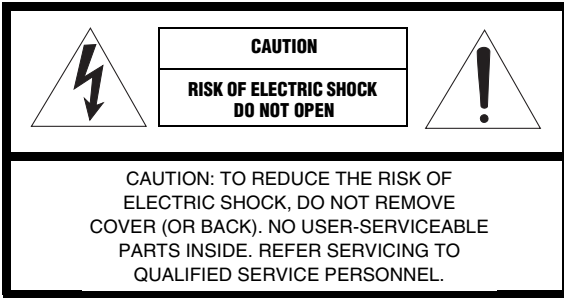

## • Explanation of Graphical Symbols



The lightning flash with arrowhead symbol, within an equilateral triangle, is intended to alert you to the presence of uninsulated “dangerous voltage” within the product’s enclosure that may be of sufficient magnitude to constitute a risk of electric shock to persons.



The exclamation point within an equilateral triangle is intended to alert you to the presence of important operating and maintenance (servicing) instructions in the literature accompanying the appliance.

- 1 Read Instructions – All the safety and operating instructions should be read before the product is operated.
  - 2 Retain Instructions – The safety and operating instructions should be retained for future reference.
  - 3 Heed Warnings – All warnings on the product and in the operating instructions should be adhered to.
  - 4 Follow Instructions – All operating and use instructions should be followed.
  - 5 Cleaning – Unplug this product from the wall outlet before cleaning. Do not use liquid cleaners or aerosol cleaners.
  - 6 Attachments – Do not use attachments not recommended by the product manufacturer as they may cause hazards.
  - 7 Water and Moisture – Do not use this product near water – for example, near a bath tub, wash bowl, kitchen sink, or laundry tub; in a wet basement; or near a swimming pool; and the like.
  - 8 Accessories – Do not place this product on an unstable cart, stand, tripod, bracket, or table. The product may fall, causing serious injury to a child or adult, and serious damage to the product. Use only with a cart, stand, tripod, bracket, or table recommended by the manufacturer, or sold with the product. Any mounting of the product should follow the manufacturer’s instructions, and should use a mounting accessory recommended by the manufacturer.
  - 9 A product and cart combination should be moved with care. Quick stops, excessive force, and uneven surfaces may cause the product and cart combination to overturn.
- 
- 10 Ventilation – Slots and openings in the cabinet are provided for ventilation and to ensure reliable operation of the product and to protect it from overheating, and these openings must not be blocked or covered. The openings should never be blocked by placing the product on a bed, sofa, rug, or other similar surface. This product should not be placed in a built-in installation such as a bookcase or rack unless proper ventilation is provided or the manufacturer’s instructions have been adhered to.
  - 11 Power Sources – This product should be operated only from the type of power source indicated on the marking label. If you are not sure of the type of power supply to your home, consult your product dealer or local power company. For products intended to operate from battery power, or other sources, refer to the operating instructions.
  - 12 Grounding or Polarization – This product may be equipped with a polarized alternating current line plug (a plug having one blade wider than the other). This plug will fit into the power outlet only one way. This is a safety feature. If you are unable to insert the plug fully into the outlet, try reversing the plug. If the plug should still fail to fit, contact your electrician to replace your obsolete outlet. Do not defeat the safety purpose of the polarized plug.
  - 13 Power-Cord Protection – Power-supply cords should be routed so that they are not likely to be walked on or pinched by items placed upon or against them, paying particular attention to cords at plugs, convenience receptacles, and the point where they exit from the product.
  - 14 Lightning – For added protection for this product during a lightning storm, or when it is left unattended and unused for long periods of time, unplug it from the wall outlet and disconnect the antenna or cable system. This will prevent damage to the product due to lightning and power-line surges.
  - 15 Power Lines – An outside antenna system should not be located in the vicinity of overhead power lines or other electric light or power circuits, or where it can fall into such power lines or circuits. When installing an outside antenna system, extreme care should be taken to keep from touching such power lines or circuits as contact with them might be fatal.
  - 16 Overloading – Do not overload wall outlets, extension cords, or integral convenience receptacles as this can result in a risk of fire or electric shock.
  - 17 Object and Liquid Entry – Never push objects of any kind into this product through openings as they may touch dangerous voltage points or short-out parts that could result in a fire or electric shock. Never spill liquid of any kind on the product.
  - 18 Servicing – Do not attempt to service this product yourself as opening or removing covers may expose you to dangerous voltage or other hazards. Refer all servicing to qualified service personnel.
  - 19 Damage Requiring Service – Unplug this product from the wall outlet and refer servicing to qualified service personnel under the following conditions:
    - a) When the power-supply cord or plug is damaged,
    - b) If liquid has been spilled, or objects have fallen into the product,
    - c) If the product has been exposed to rain or water,

- d) If the product does not operate normally by following the operating instructions. Adjust only those controls that are covered by the operating instructions as an improper adjustment of other controls may result in damage and will often require extensive work by a qualified technician to restore the product to its normal operation,
  - e) If the product has been dropped or damaged in any way, and
  - f) When the product exhibits a distinct change in performance - this indicates a need for service.
- 20 Replacement Parts** – When replacement parts are required, be sure the service technician has used replacement parts specified by the manufacturer or have the same characteristics as the original part. Unauthorized substitutions may result in fire, electric shock, or other hazards.
- 21 Safety Check** – Upon completion of any service or repairs to this product, ask the service technician to perform safety checks to determine that the product is in proper operating condition.
- 22 Wall or Ceiling Mounting** – The unit should be mounted to a wall or ceiling only as recommended by the manufacturer.
- 23 Heat** – The product should be situated away from heat sources such as radiators, heat registers, stoves, or other products (including amplifiers) that produce heat.

- 24 Outdoor Antenna Grounding** – If an outside antenna or cable system is connected to the product, be sure the antenna or cable system is grounded so as to provide some protection against voltage surges and built-up static charges. Article 810 of the National Electrical Code, ANSI/NFPA 70, provides information with regard to proper grounding of the mast and supporting structure, grounding of the lead-in wire to an antenna discharge unit, size of grounding conductors, location of antenna discharge unit, connection to grounding electrodes, and requirements for the grounding electrode.

EXAMPLE OF ANTENNA GROUNDING

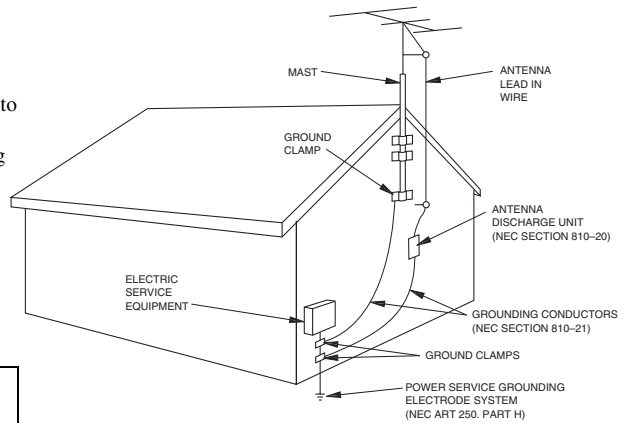

NEC – NATIONAL ELECTRICAL CODE

**Note to CATV system installer:**

This reminder is provided to call the CATV system installer’s attention to Article 820-40 of the NEC that provides guidelines for proper grounding and, in particular, specifies that the cable ground shall be connected to the grounding system of the building, as close to the point of cable entry as practical.

**FCC INFORMATION (for US customers)**

**1 IMPORTANT NOTICE: DO NOT MODIFY THIS UNIT!**

This product, when installed as indicated in the instructions contained in this manual, meets FCC requirements. Modifications not expressly approved by Yamaha may void your authority, granted by the FCC, to use the product.

- 2 IMPORTANT:** When connecting this product to accessories and/or another product use only high quality shielded cables. Cable/s supplied with this product **MUST** be used. Follow all installation instructions. Failure to follow instructions could void your FCC authorization to use this product in the USA.

- 3 NOTE:** This product has been tested and found to comply with the requirements listed in FCC Regulations, Part 15 for Class “B” digital devices. Compliance with these requirements provides a reasonable level of assurance that your use of this product in a residential environment will not result in harmful interference with other electronic devices.

This equipment generates/uses radio frequencies and, if not installed and used according to the instructions found in the users manual, may cause interference harmful to the operation of other electronic devices.

Compliance with FCC regulations does not guarantee that interference will not occur in all installations. If this product is found to be the source of interference, which can be determined by turning the unit “OFF” and “ON”, please try to eliminate the problem by using one of the following measures:

Relocate either this product or the device that is being affected by the interference.

Utilize power outlets that are on different branch (circuit breaker or fuse) circuits or install AC line filter/s.

In the case of radio or TV interference, relocate/reorient the antenna. If the antenna lead-in is 300 ohm ribbon lead, change the lead-in to coaxial type cable.

If these corrective measures do not produce satisfactory results, please contact the local retailer authorized to distribute this type of product. If you can not locate the appropriate retailer, please contact Yamaha Electronics Corp., U.S.A. 6660 Orangethorpe Ave., Buena Park, CA 90620.

The above statements apply **ONLY** to those products distributed by Yamaha Corporation of America or its subsidiaries.

## Caution: Read this before operating your unit.

- 1 To assure the finest performance, please read this manual carefully. Keep it in a safe place for future reference.
- 2 Install this sound system in a well ventilated, cool, dry, clean place – away from direct sunlight, heat sources, vibration, dust, moisture, and/or cold. Allow ventilation space of at least 30 cm on the top, 20 cm on the left and right, and 20 cm on the back of this unit.
- 3 Locate this unit away from other electrical appliances, motors, or transformers to avoid humming sounds.
- 4 Do not expose this unit to sudden temperature changes from cold to hot, and do not locate this unit in an environment with high humidity (i.e. a room with a humidifier) to prevent condensation inside this unit, which may cause an electrical shock, fire, damage to this unit, and/or personal injury.
- 5 Avoid installing this unit where foreign objects may fall onto this unit and/or this unit may be exposed to liquid dripping or splashing. On the top of this unit, do not place:
  - Other components, as they may cause damage and/or discoloration on the surface of this unit.
  - Burning objects (i.e. candles), as they may cause fire, damage to this unit, and/or personal injury.
  - Containers with liquid in them, as they may fall and liquid may cause electrical shock to the user and/or damage to this unit.
- 6 Do not cover this unit with a newspaper, tablecloth, curtain, etc. in order not to obstruct heat radiation. If the temperature inside this unit rises, it may cause fire, damage to this unit, and/or personal injury.
- 7 Do not plug in this unit to a wall outlet until all connections are complete.
- 8 Do not operate this unit upside-down. It may overheat, possibly causing damage.
- 9 Do not use force on switches, knobs and/or cords.
- 10 When disconnecting the power cable from the wall outlet, grasp the plug; do not pull the cable.
- 11 Do not clean this unit with chemical solvents; this might damage the finish. Use a clean, dry cloth.
- 12 Only voltage specified on this unit must be used. Using this unit with a higher voltage than specified is dangerous and may cause fire, damage to this unit, and/or personal injury. Yamaha will not be held responsible for any damage resulting from use of this unit with a voltage other than specified.
- 13 To prevent damage by lightning, keep the power cord and outdoor antennas disconnected from a wall outlet or the unit during a lightning storm.
- 14 Do not attempt to modify or fix this unit. Contact qualified Yamaha service personnel when any service is needed. The cabinet should never be opened for any reasons.
- 15 When not planning to use this unit for long periods of time (i.e. vacation), disconnect the AC power plug from the wall outlet.
- 16 Install this unit near the AC outlet and where the AC power plug can be reached easily.
- 17 Be sure to read the “TROUBLESHOOTING” section on common operating errors before concluding that this unit is faulty.
- 18 Before moving this unit, press MASTER ON/OFF to release it outward to the OFF position to turn off this unit, and then disconnect the AC power plug from the AC wall outlet.
- 19 **VOLTAGE SELECTOR** (Asia and General models only)  
The VOLTAGE SELECTOR on the rear panel of this unit must be set for your local main voltage BEFORE plugging into the AC wall outlet. Voltages are:
  - Asia model ..... 220/230–240 V AC, 50/60 Hz
  - General model ..... 110/120/220/230–240 V AC, 50/60 Hz
- 20 The batteries shall not be exposed to excessive heat such as sunshine, fire or like.

### WARNING

TO REDUCE THE RISK OF FIRE OR ELECTRIC SHOCK, DO NOT EXPOSE THIS UNIT TO RAIN OR MOISTURE.

As long as this unit is connected to the AC wall outlet, it is not disconnected from the AC power source even if you turn off this unit by MASTER ON/OFF. In this state, this unit is designed to consume a very small quantity of power.

### FOR CANADIAN CUSTOMERS

To prevent electric shock, match wide blade of plug to wide slot and fully insert.

This Class B digital apparatus complies with Canadian ICES-003.

### POUR LES CONSOMMATEURS CANADIENS

Pour éviter les chocs électriques, introduire la lame la plus large de la fiche dans la borne correspondante de la prise et pousser jusqu'au fond.

Cet appareil numérique de la classe B est conforme à la norme NMB-003 du Canada.

### IMPORTANT

Please record the serial number of this unit in the space below.

MODEL:

Serial No.:

The serial number is located on the rear of the unit.

Retain this Owner's Manual in a safe place for future reference.

# Contents

## INTRODUCTION

Notice .....	2
Features .....	3
Supplied accessories .....	3
Getting started .....	4
Quick start guide .....	5

## PREPARATION

Connections .....	11
Optimizing the speaker setting for your listening room .....	28
Using AUTO SETUP .....	28

## BASIC OPERATION

Selecting the SCENE templates.....	33
Selecting the desired SCENE template.....	33
Creating your original SCENE templates.....	36
Playback .....	37
Basic procedure .....	37
Selecting the MULTI CH INPUT component.....	38
Selecting the front speaker set .....	38
Selecting audio input jacks (AUDIO SELECT).....	39
Displaying the current status of this unit on a video monitor.....	39
Using your headphones.....	40
Muting the audio output.....	40
Playing video sources in the background of an audio source.....	40
Displaying the input source information .....	40
Using the sleep timer .....	41
Sound field programs .....	42
Selecting sound field programs .....	42
Sound field program descriptions .....	42
Enjoying unprocessed input sources (Straight decoding mode) .....	47
Using audio features .....	48
Enjoying pure hi-fi sound .....	48
Adjusting the tonal quality.....	48
Adjusting the speaker level.....	48
Enjoying multi-channel sources in 2-channel stereo.....	49
Selecting the night listening mode.....	49
FM/AM tuning .....	50
Automatic tuning .....	50
Manual tuning .....	50
Automatic preset tuning.....	51
Manual preset tuning .....	51
Selecting preset stations.....	52
Exchanging preset stations .....	52
XM Satellite Radio tuning .....	53
Connecting the XM Mini-Tuner Dock .....	53
Activating XM Satellite Radio .....	54
Basic XM Satellite Radio operations.....	54
Setting the XM Satellite Radio preset channels .....	56
Displaying the XM Satellite Radio information .....	57
Using iPod™.....	58
Controlling iPod™.....	58
Recording .....	60

## ADVANCED OPERATION

Advanced sound configurations.....	61
Changing sound field parameter settings.....	61
Selecting decoders .....	66
Customizing this unit (MANUAL SETUP).....	69
Using SET MENU.....	71
1 SOUND MENU.....	72
2 INPUT MENU.....	78
3 OPTION MENU .....	81
Remote control features.....	84
Using the remote control for the SCENE feature.....	84
Controlling this unit, a TV, or other components .....	85
Setting remote control codes .....	87
Resetting all remote control codes.....	88
Using multi-zone configuration.....	89
Connecting Zone 2.....	89
Controlling Zone 2.....	90
Advanced setup.....	92
Using the advanced setup .....	92

## ADDITIONAL INFORMATION

Troubleshooting.....	96
Resetting the system.....	103
Glossary.....	104
Sound field program information.....	106
Parametric equalizer information .....	107
Specifications .....	108
Index.....	110

## APPENDIX

(at the end of this manual)

Front panel.....	i
Remote control .....	ii
List of remote control codes .....	iii

“**①**SPEAKERS” or “**Ⓐ**DVD” (example) indicates the name of the parts on the front panel or the remote control. Refer to the attached sheet or the pages at the end of this manual for the information about each position of the parts.

INTRODUCTION

PREPARATION

BASIC  
OPERATION

ADVANCED  
OPERATION





ADDITIONAL  
INFORMATION

APPENDIX

English

# Notice

## About this manual

-  indicates a tip for your operation.
- Some operations can be performed by using either the buttons on the front panel or the ones on the remote control. In case the button names differ between the front panel and the remote control, the button name on the remote control is given in parentheses.
- This manual is printed prior to production. Design and specifications are subject to change in part as a result of improvements, etc. In case of differences between the manual and product, the product has priority.
- “ **SPEAKERS**” or “ **DVD**” (example) indicates the name of the parts on the front panel or the remote control. Refer to the attached sheet or the pages at the end of this manual for the information about each position of the parts.
- The symbol “” with page number(s) indicates the corresponding reference page(s).

## We Want You Listening For A Lifetime



Yamaha and the Electronic Industries Association's Consumer Electronics Group want you to get the most out of your equipment by playing it at a safe level. One that lets the sound come through loud and clear without annoying blaring or distortion – and, most importantly, without affecting your sensitive

hearing. Since hearing damage from loud sounds is often undetectable until it is too late, Yamaha and the Electronic Industries Association's Consumer Electronics Group recommend you to avoid prolonged exposure from excessive volume levels.



Manufactured under license from Dolby Laboratories. “Dolby”, “Pro Logic”, and the double-D symbol are trademarks of Dolby Laboratories.



DTS-ES | NEO:6 | 96/24. Product “DTS” and “DTS-ES | NEO:6” are registered trademarks of DTS, Inc. “96/24” is a trademark of DTS, Inc.

### iPod™

“iPod” is a trademark of Apple Computer, Inc., registered in the U.S. and other countries.



“HDMI”, the “HDMI” logo and “High-Definition Multimedia Interface” are trademarks or registered trademarks of HDMI Licensing LLC.

### SILENT™ CINEMA

“SILENT CINEMA” is a trademark of YAMAHA CORPORATION.



The XM name and related logos are registered trademarks of XM Satellite Radio Inc.



Neural Surround™ name and related logos are trademarks owned by Neural Audio Corporation.

# Features

## Built-in 7-channel power amplifier

- ◆ Minimum RMS output power (20 Hz to 20 kHz, 0.06% THD, 8 Ω)  
Front: 90 W + 90 W  
Center: 90 W  
Surround: 90 W + 90 W  
Surround back: 90 W + 90 W

## SCENE function

- ◆ 18 preset SCENE templates for various situations
- ◆ 4 original SCENE templates for customizing capability
- ◆ Controlling Yamaha SCENE control signal support component (some models only) working with the SCENE function

## Sound field programs

- ◆ Proprietary Yamaha technology for the creation of sound fields
- ◆ Compressed Music Enhancer mode to improve the sound quality of compression artifacts (such as the MP3 format) to that of a high-quality stereo
- ◆ Dolby Digital/Dolby Digital EX decoder
- ◆ DTS/DTS-ES Matrix, Discrete, DTS Neo:6, DTS 96/24 decoder
- ◆ Dolby Pro Logic/Dolby Pro Logic II/Dolby Pro Logic IIx decoder
- ◆ Neural Surround decoder
- ◆ Virtual CINEMA DSP
- ◆ SILENT CINEMA

## Sophisticated FM/AM tuner

- ◆ 40-station random and direct preset tuning
- ◆ Automatic preset tuning
- ◆ Preset station shifting capability (preset editing)

## XM Satellite Radio

- ◆ XM Satellite Radio tuning capability (using the “XM Mini-Tuner Dock” sold separately)
- ◆ Neural Surround decoder to play back the XM HD content of XM Satellite Radio broadcasts in multi-channels, resulting in a full surround sound experience
- ◆ XM Satellite Radio information displaying capability

## HDMI (High-Definition Multimedia Interface)

- ◆ HDMI interface for standard, enhanced or high-definition video (includes 1080p video signal transmission) as well as multi-channel digital audio based on HDMI version 1.2a

## iPod controlling capability

- ◆ DOCK terminal to connect a Yamaha iPod universal dock (such as the YDS-10, sold separately), which supports iPod (Click and Wheel), iPod nano, and iPod mini
- ◆ Playback information displaying capability
- ◆ Battery charging capability

## Other features

- ◆ YPAO (Yamaha Parametric Room Acoustic Optimizer) for automatic speaker setup
- ◆ 192-kHz/24-bit D/A converter
- ◆ OSD (on-screen display) menus that allow you to optimize this unit to suit your individual audiovisual system
- ◆ 5.1 or 7.1-channel additional input jacks for discrete multi-channel input
- ◆ S-video signal input/output capability
- ◆ Component video input/output capability includes (3 COMPONENT VIDEO INs and 1 MONITOR OUT)
- ◆ Digital video signal conversion (composite video ↔ S-video → component video) capability for monitor out
- ◆ Optical and coaxial digital audio signal jacks
- ◆ Pure Direct mode for pure hi-fi sound for all sources
- ◆ Cinema and music night listening modes
- ◆ Remote control with preset remote control codes capability
- ◆ Zone 2 custom installation facility
- ◆ Zone switching capability between the main zone and Zone 2 using ZONE CONTROL
- ◆ Bi-amplification connection capability
- ◆ Sleep timer

## Supplied accessories

Check that you received all of the following parts.

Remote control



Batteries (2)  
(AA, R6, UM-3)

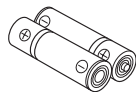

AM loop antenna



Optimizer microphone



Indoor FM antenna

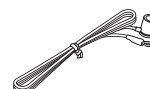

### Note

The form of the supplied accessories varies depending on the models.

# Getting started

## ■ Installing batteries in the remote control

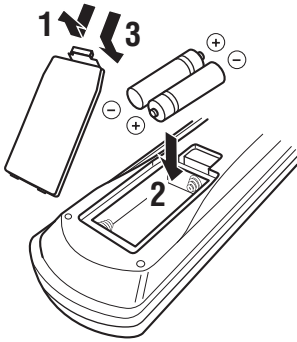

**1** Take off the battery compartment cover.

**2** Insert the two supplied batteries (AA, R6, UM-3) according to the polarity markings (+ and -) on the inside of the battery compartment.

**3** Snap the battery compartment cover back into place.

### Notes

- Change all of the batteries if you notice the following conditions:
  - the operation range of the remote control decreases.
  - the **TRANSMIT** indicator does not flash or its light becomes dim.
- Do not use an old battery together with a new one.
- Do not use different types of batteries (such as alkaline and manganese batteries) together. Read the packaging carefully as these different types of batteries may have the same shape and color.
- If the batteries have leaked, dispose of them immediately. Avoid touching the leaked material or letting it come into contact with clothing, etc. Clean the battery compartment thoroughly before installing new batteries.
- Do not throw away batteries with general house waste; dispose of them correctly in accordance with your local regulations.
- If the remote control is without batteries for more than 2 minutes, or if exhausted batteries remain in the remote control, the contents of the memory may be cleared. When the memory is cleared, insert new batteries, set up the remote control code and program any acquired functions that may have been cleared.

## ■ VOLTAGE SELECTOR (Asia and General models only)

### Caution

The **VOLTAGE SELECTOR** on the rear panel of this unit must be set for your local voltage **BEFORE** plugging the power cable into the AC wall outlet. Improper setting of the **VOLTAGE SELECTOR** may cause damage to this unit and create a potential fire hazard.

Rotate the **VOLTAGE SELECTOR** clockwise or counterclockwise to the correct position using a straight slot screwdriver.

Voltages are as follows:

Asia model ..... 220/230–240 V AC, 50/60 Hz

General model ..... 110/120/220/230–240 V AC, 50/60 Hz

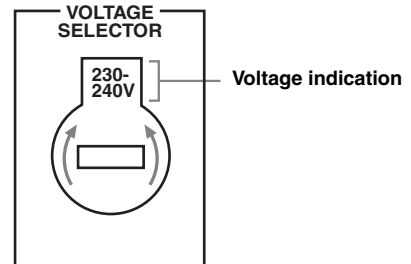



# Quick start guide

The following steps describe the easiest way to enjoy DVD movie playback in your home theater.

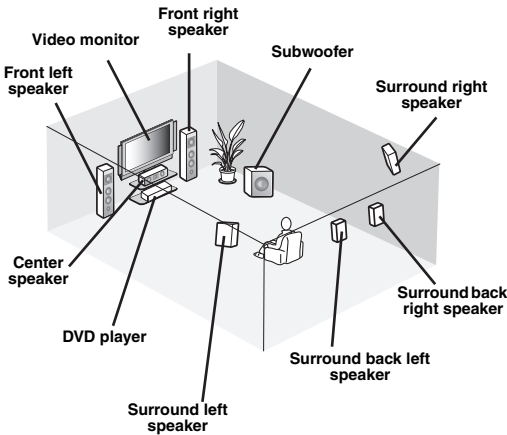

## Preparation: Check the items

In these steps, you need the following supplied accessories.

- AM loop antenna
- Indoor FM antenna

The following items are not included in the package of this unit.

- Speakers**
  - Front speakers ..... 2
  - Center speaker ..... 1
  - Surround speakers ..... 4

Select magnetically shielded speakers. The minimum required speakers are two front speakers. The priority of the requirement of other speakers is as follows:

1. Two surround speakers
2. Center speaker
3. One (or two) surround back speaker(s)

- Active subwoofer** ..... 1  
Select an active subwoofer equipped with an RCA input jack.
- Speaker cables** ..... 7
- Subwoofer cable** ..... 1  
Select a monaural RCA cable.
- DVD player** ..... 1  
Select DVD player equipped with coaxial digital audio output jack and composite video output jack.
- Video monitor** ..... 1  
Select a TV monitor, video monitor or projector equipped with a composite video input jack.
- Video cable** ..... 1  
Select an RCA composite video cable.
- Digital coaxial audio cable** ..... 1

### Step 1: Set up your speakers

P. 6

### Step 2: Connect your DVD player and other components

P. 7

### Step 3: Turn on the power and press SCENE 1 button

P. 9

**Enjoy DVD playback!**

## Step 1: Set up your speakers

Place your speakers in the room and connect them to this unit.

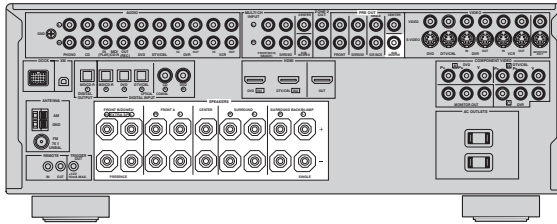

**1 Place your speakers and subwoofer in the room.**

**2 Connect speaker cables to each speaker.**

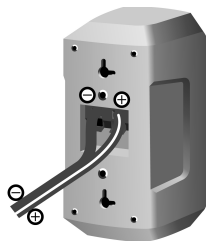

Be sure to connect the “+” (red) and “-” (black) properly. Cables are colored or shaped differently, perhaps with a stripe, groove or ridge. Connect the striped (grooved, etc.) cable to the “+” (red) terminals of this unit and your speaker. Connect the plain cable to the “-” (black) terminals.

**3 Connect each speaker cable to the corresponding speaker terminal of this unit.**

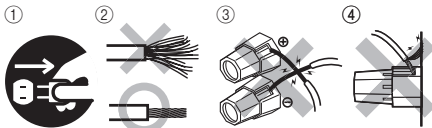

- ① Make sure that this unit and the subwoofer are unplugged from the AC wall outlets.
- ② Twist the exposed wires of the speaker cables together to prevent short circuits.
- ③ Do not let the bare speaker wires touch each other.
- ④ Do not let the bare speaker wires touch any metal part of this unit.

Be sure to connect the left channel (L), right channel (R), “+” (red) and “-” (black) properly.

### Front speakers and center speaker

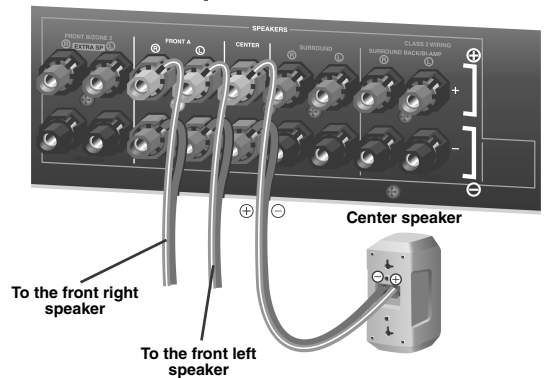
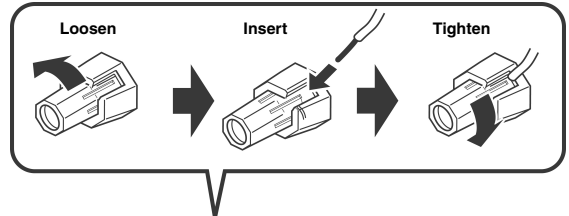

### Surround and surround back speakers

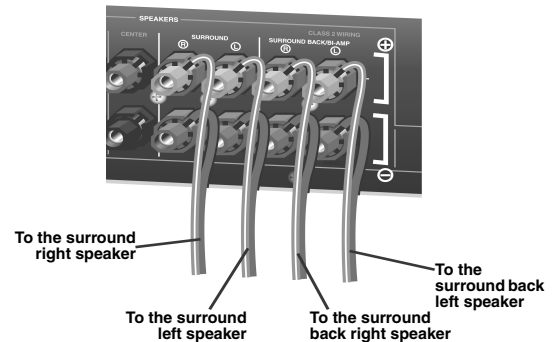

**5 Connect the subwoofer cable to the SUBWOOFER PRE OUT jack of this unit and the input jack of the subwoofer.**

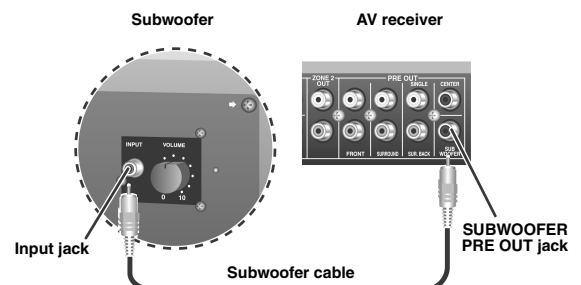

## Step 2: Connect your DVD player and other components

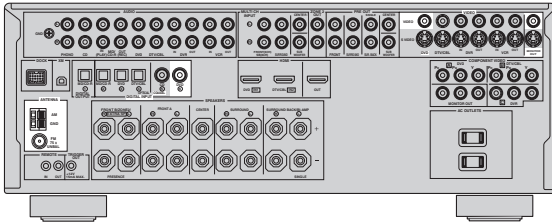

Make sure that this unit and the DVD player are unplugged from the AC wall outlets.

- 1 Connect the digital coaxial audio cable to the digital coaxial audio output jack of your DVD player and the DVD COAXIAL jack of this unit.

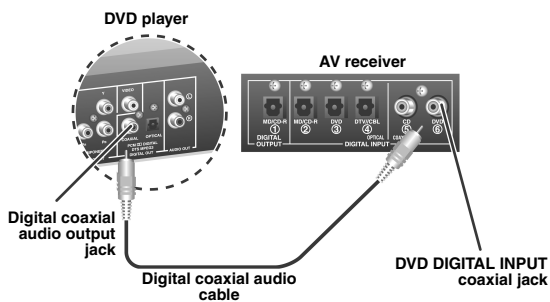

- 2 Connect the video cable to the composite video output jack of your DVD player and DVD VIDEO jack of this unit.

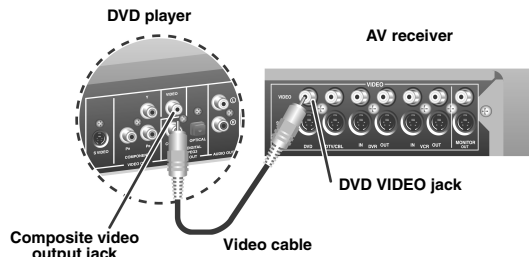

- 3 Connect the video cable to the VIDEO MONITOR OUT jack of this unit and the video input jack of your video monitor.

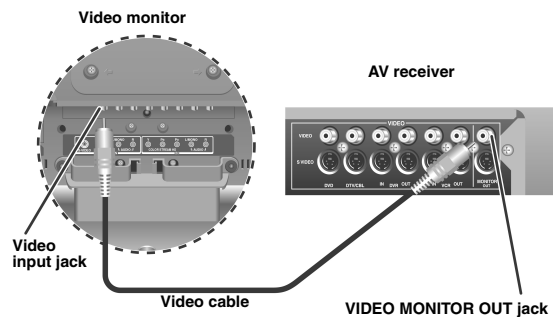

**4 Connect the supplied AM loop antenna and indoor FM antenna to this unit.**

See page 24 for the connection information.

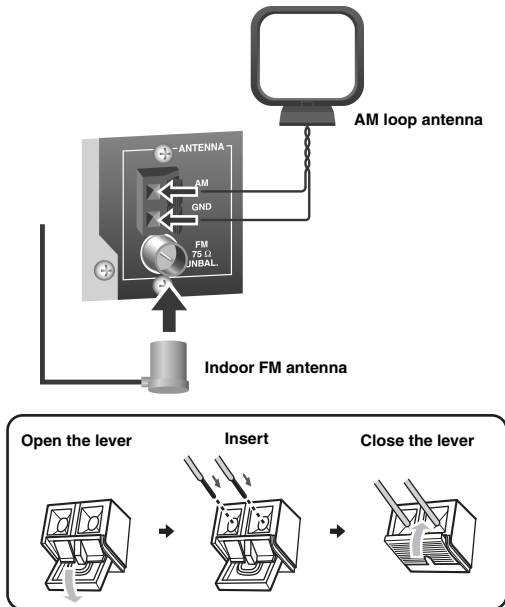

The wire of the AM loop antenna does not have any polarity and you can connect either end of the wire to AM or GND terminal

**Assembling the supplied AM loop antenna**

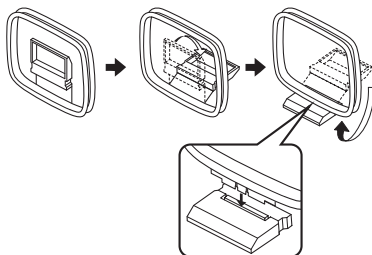

**5 Connect the power plug of this unit and other components into the AC wall outlet.**



This unit is equipped with AC OUTLET(S) for the power supply of the other components (except Korea model). See page 24 for details.

**Note**

The type of the power plug is different depending on the models.

**■ For further connections**

- Using the other kind of speaker combinations P. 12
- Connecting a video monitor via various ways of the connection P. 18
- Connecting a DVD player via various ways of the connection P. 19
- Connecting a DVD recorder or a digital video recorder P. 20
- Connecting a set-top box P. 20
- Connecting a CD player, an MD recorder or a turntable P. 21
- Connecting an external amplifier P. 22
- Connecting a DVD player via analog multi-channel audio connection P. 22
- Connecting a Yamaha iPod universal dock P. 23
- Using the REMOTE IN/OUT jacks P. 23
- Using the VIDEO AUX jacks on the front panel P. 23
- Connecting an outdoor FM/AM antenna P. 24
- Connecting the XM Mini-Tuner Dock P. 53

### Step 3: Turn on the power and press SCENE 1 button

#### Check the type of the connected speakers.

If the speakers are 6 ohm speakers, set “SP IMP.” to “6Ω MIN” before using this unit (see page 25). 4 ohm speakers can be also used as the front speakers (see page 93).

- 1 Turn on the video monitor connected to this unit.

- 2 Press **Ⓜ** MASTER ON/OFF inward to the ON position on the front panel.



- 3 Press **Ⓛ** SCENE1 button.

“DVD Viewing” appears in the front panel display, and this unit automatically optimize own status for the DVD playback.



The indicator on the selected SCENE button lights up while this unit is in the SCENE mode.

- 4 Start playback of the desired DVD on your player.



If the connected DVD player is a Yamaha product and has capability of the SCENE control signals with the REMOTE OUT jack of this unit (see page 23), this unit can automatically activate the DVD player and start playback when you press the **Ⓛ** SCENE1 button. Refer to the instruction manual of the DVD player for further information.

- 5 Rotate **Ⓢ** VOLUME to adjust the volume.



#### Note

When you change the input source or sound field program, the SCENE mode is deactivated, and the indicator on the selected SCENE button turns off.

#### Using the other SCENE buttons

In the following cases, try pressing the corresponding SCENE button to enjoy the playback of the desired sources.

**Case A:** “I want to listen to a music disc from the connected DVD player as the background music for this room...”

➔ Press **Ⓜ** SCENE2 (or **Ⓛ** SCENE2) to select “Disc Listening”.

**Case B:** “I want to watch a TV program...”

➔ Press **Ⓜ** SCENE3 (or **Ⓛ** SCENE3) to select “TV Viewing”.

**Case C:** “I want to listen to a music program of the FM/AM radio station...”

➔ Press **Ⓜ** SCENE4 (or **Ⓛ** SCENE4) to select “Radio Listening”.

**Notes**

- To use the “TV Viewing” template (Case B), you must connect a satellite receiver, a cable TV receiver or an HDTV decoder to this unit in advance. See page 20 for details.
- To use the “Radio Listening” template (Case C), you have to tune into the desired radio station. See pages 50 to 52 for the tuning information.
- To achieve the best possible reception, orient the connected AM loop antenna, or adjust the position of the end of the indoor FM antenna.



If you cannot find the desired situation, you can select and change the assigned SCENE template for the SCENE buttons. See page 33 for details.

### ■ After using this unit...

Press **Ⓜ MAIN ZONE ON/OFF** to set this unit to the standby mode.



This unit is set to the standby mode and consumes a small amount of power in order to receive infrared signals from the remote control. To turn on this unit from the standby mode, press the desired **Ⓢ SCENE** buttons (or **Ⓢ SCENE**) or **Ⓜ MAIN ZONE ON/OFF** on the front panel (or **Ⓜ POWER** on the remote control). See page 25 for details.

## What do you want to do with this unit?

### ■ Customizing the SCENE templates

- Using various SCENE templates ☞ P. 33
- Creating your original SCENE templates ☞ P. 36

### ■ Using various input sources

- Basic controls of this unit ☞ P. 37
- Enjoying FM/AM radio programs ☞ P. 50
- Enjoying XM Satellite Radio programs ☞ P. 53
- Using your iPod with this unit. ☞ P. 58

### ■ Using various sound features

- Using various sound field programs ☞ P. 42
- Using the pure direct mode for high fidelity sound ☞ P. 48
- Customizing the sound field programs ☞ P. 61

### ■ Adjusting the parameters of this unit

- Automatically optimizing the speaker parameters for your listening room (AUTO SETUP) ☞ P. 28
- Manually adjusting various parameters of this unit manually ☞ P. 71
- Setting the remote control ☞ P. 84
- Adjusting the advanced parameters ☞ P. 92

### ■ Additional features

Automatically turning off this unit

☞ P. 41

# Connections

## Rear panel

### XM jack (U.S.A. and Canada models only)

Connect the XM Mini-Tuner Dock (sold separately).

☞ P. 53

### DOCK terminal

Connect a Yamaha iPod universal dock (sold separately).

☞ P. 23

### AUDIO jacks

Connect the analog audio cable plugs.

☞ P. 18-21

### ZONE 2 OUT jacks

Connect the amplifier in Zone 2.

☞ P. 89

### Video jacks

Connect the video cable plugs.

☞ P. 18-20

### MULTI CH INPUT jacks

Connect the input source component equipped with the multi-channel output jacks.

☞ P. 22

### PRE OUT jacks

Connect external amplifiers and an active subwoofer.

☞ P. 22

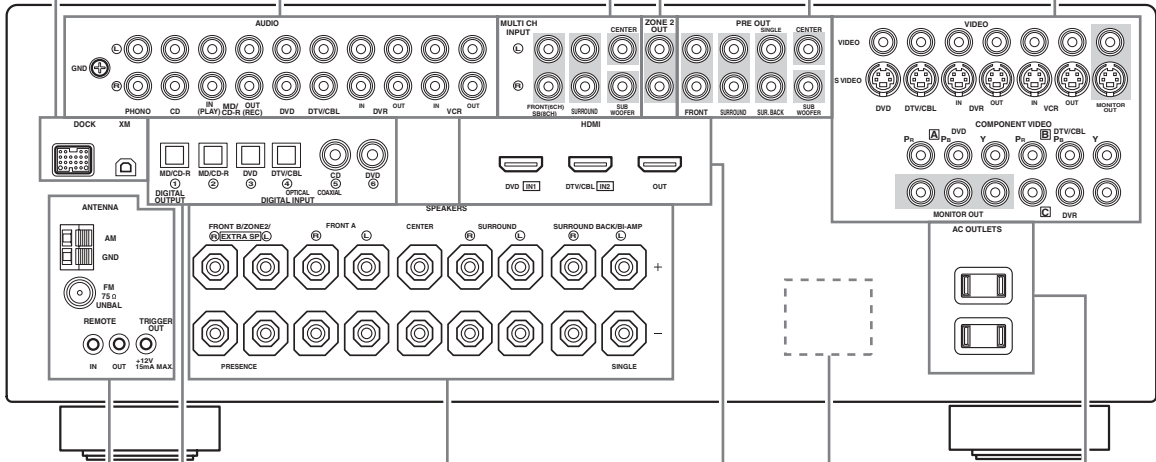

### DIGITAL INPUT/OUTPUT jacks

Connect the digital audio cable plugs.

☞ P. 19-21

### Speaker terminals

Connect the speakers.

☞ P. 13

### VOLTAGE SELECTOR (Asia and General models only)

☞ P. 4

### HDMI connectors

Connect the HDMI components.

☞ P. 16

### AC OUTLET(S)

☞ P. 24

### ANTENNA terminals

Connect the FM and AM antenna.

☞ P. 24

### REMOTE IN/OUT jacks

Connect the remote control input and output jacks of the Yamaha components.

☞ P. 23

### TRIGGER OUT

Outputs the control signals to external components.

## Placing speakers

The speaker layout below shows the speaker setting we recommend. You can use it to enjoy CINEMA DSP and multi-channel audio sources.

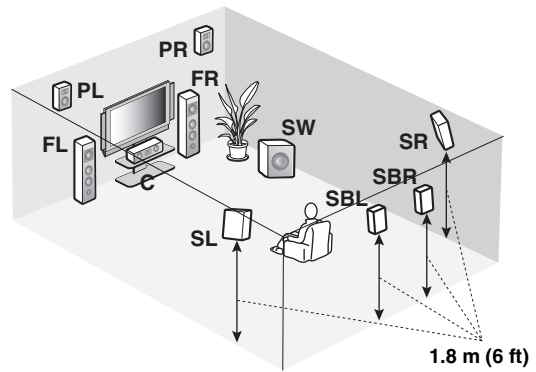
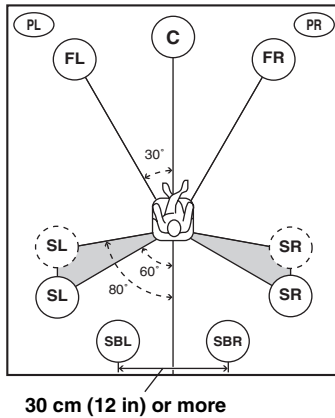

### Front left and right speakers (FL and FR)

The front speakers are used for the main source sound plus effect sounds. Place these speakers at an equal distance from the ideal listening position. The distance of each speaker from each side of the video monitor should be the same.

### Center speaker (C)

The center speaker is for the center channel sounds (dialog, vocals, etc.). If for some reason it is not practical to use a center speaker, you can do without it. Best results, however, are obtained with the full system.

### Surround left and right speakers (SL and SR)

The surround speakers are used for effect and surround sounds.

### Surround back left and right speakers (SBL and SBR)

The surround back speakers supplement the surround speakers and provide more realistic front-to-back transitions.

### Presence left and right speakers (PL and PR)

The presence speakers supplement the sound from the front speakers with extra ambient effects produced by the sound field programs (see page 42). To use the presence speakers, connect the speakers to EXTRA SP terminals and then set "EXTRA SP ASSIGN" to "PRESENCE" (see pages 29 and 72).

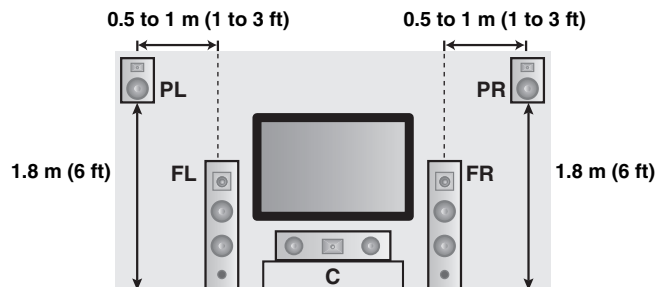

### Subwoofer (SW)

The use of a subwoofer with a built-in amplifier, such as the Yamaha Active Servo Processing Subwoofer System, is effective not only for reinforcing bass frequencies from any or all channels, but also for high fidelity sound reproduction of the LFE (low-frequency effect) channel included in Dolby Digital and DTS sources. The position of the subwoofer is not so critical, because low bass sounds are not highly directional. But it is better to place the subwoofer near the front speakers. Turn it slightly toward the center of the room to reduce wall reflections.



## Connecting speakers

Be sure to connect the left channel (L), right channel (R), “+” (red) and “-” (black) properly. If the connections are faulty, this unit cannot reproduce the input sources accurately.

### Caution

- Before connecting the speakers, make sure that this unit is turned off (see page 25).
- Do not let the bare speaker wires touch each other or let them touch any metal part of this unit. This could damage this unit and/or the speakers. If the speaker wires are short-circuited, “CHECK SP WIRES” appears in the front panel display when you turn on this unit.
- Use the magnetically shielded speakers. If this type of speaker still creates interference with the monitor, place the speakers away from the monitor.
- If you are to use 6 ohm speakers, be sure to set “SP IMP.” to “6Ω MIN” before using this unit (see page 25). 4 ohm speakers can be also used as the front speakers (see page 93).

### Note

A speaker cord is actually a pair of insulated cables running side by side. Cables are colored or shaped differently, perhaps with a stripe, groove or ridge. Connect the striped (grooved, etc.) cable to the “+” (red) terminals of this unit and your speaker. Connect the plain cable to the “-” (black) terminals.

### EXTRA SP terminals

Connect the alternative front speaker system (FRONT B), presence speakers or Zone 2 speakers. To select the function of the speakers connected to the EXTRA SP terminals, set the “EXTRA SP ASSIGN” parameter in “SOUND MENU” (see page 72).



You can also select the function of the speakers connected to the EXTRA SP terminals in “AUTO SETUP” (see page 29).

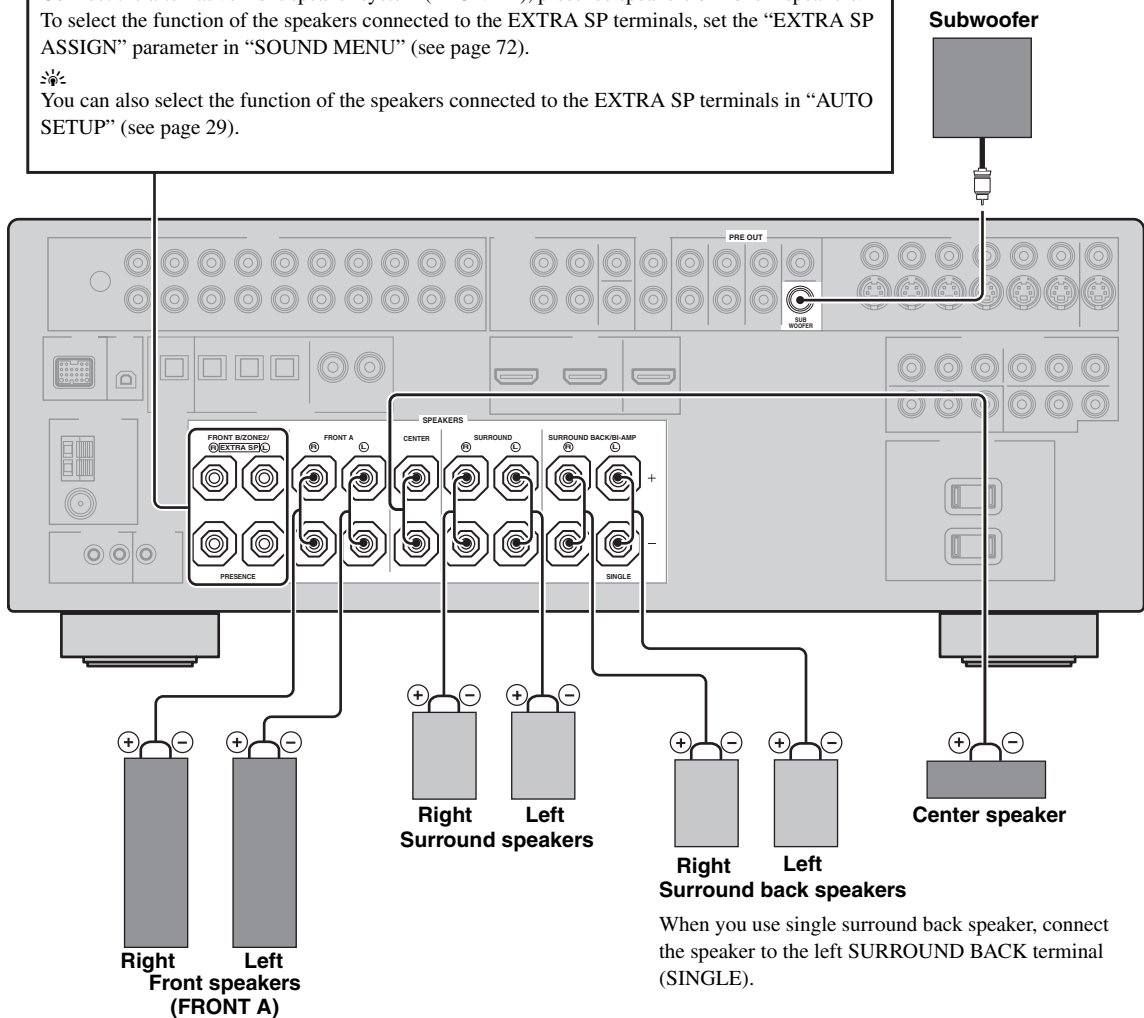

■ Connecting the speaker cable

- 1 Remove approximately 10 mm (0.4 in) of insulation from the end of each speaker cable and then twist the exposed wires of the cable together to prevent short circuits.

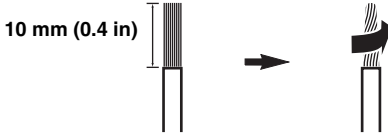

- 2 Loosen the knob.

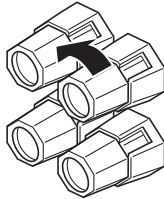

Red: positive (+)  
Black: negative (-)

- 3 Insert one bare wire into the hole on the side of each terminal.

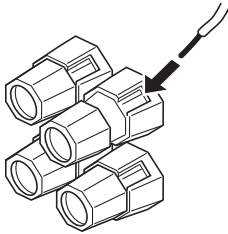

- 4 Tighten the knob to secure the wire.

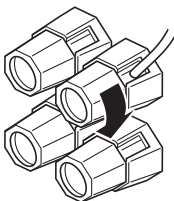

■ Connecting the banana plug (except Europe, Asia and Korea models)

Tighten the knob and then insert the banana plug connector into the end of the corresponding terminal.

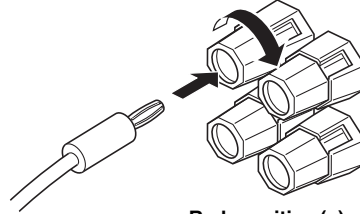

Red: positive (+)  
Black: negative (-)

■ Using bi-amplification connections

**Caution**

Remove the shorting bars or bridges to separate the LPF (low pass filter) and HPF (high pass filter) crossovers.

This unit allows you to make bi-amplification connections to one speaker system. Check if your speakers support bi-amplification.

To make the bi-amplification connections, use the FRONT and SURROUND BACK terminals as shown below. To activate the bi-amplification connections, set “BI-AMP” to “ON” in “ADVANCED SETUP” (see page 95).

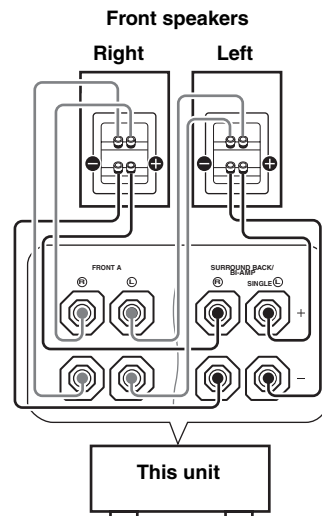

**Note**

When you make the conventional connection, make sure that the shorting bars are put into the terminals appropriately. Refer to the instruction manuals of the speakers for details.

## Information on jacks and cable plugs

### Audio jacks and cable plugs

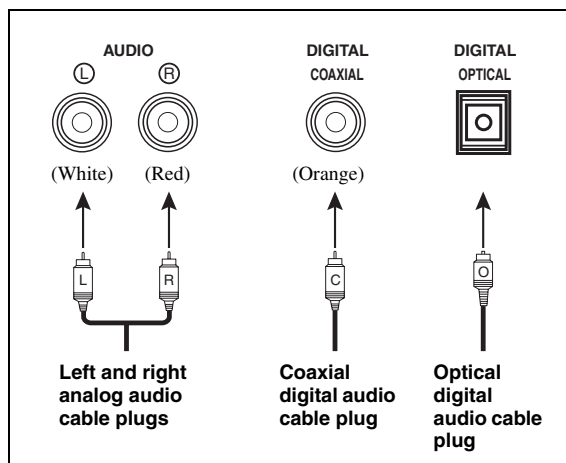

### Video jacks and cable plugs

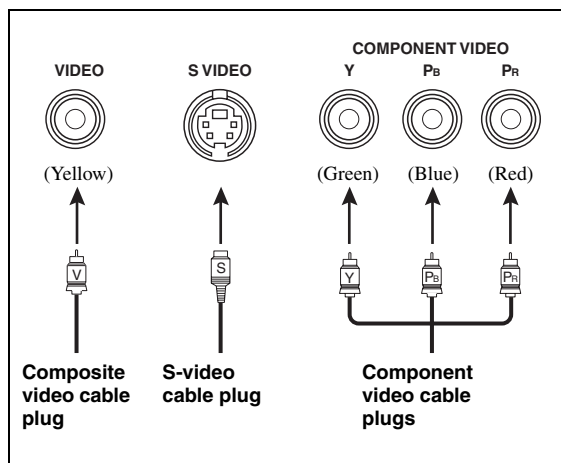

#### ■ Audio jacks

This unit has three types of audio jacks. Connection depends on the availability of audio jacks on your other components.

##### AUDIO jacks

For conventional analog audio signals transmitted via left and right analog audio cables. Connect red plugs to the right jacks and white plugs to the left jacks.

##### DIGITAL COAXIAL jacks

For digital audio signals transmitted via coaxial digital audio cables.

##### DIGITAL OPTICAL jacks

For digital audio signals transmitted via optical digital audio cables.

#### Notes

- You can use the digital jacks to input PCM, Dolby Digital and DTS bitstreams. When you connect components to both the COAXIAL and OPTICAL jacks, priority is given to the signals input at the COAXIAL jack. All digital input jacks are compatible with digital signals with up to 96 kHz of sampling frequency.
- Pull out the cap from the optical jack before you connect the fiber optic cable. Do not discard the cap. When you are not using the optical jack, be sure to put the cap back in place. This cap protects the jack from dust.

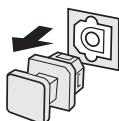

#### ■ Video jacks

This unit has three types of video jacks. Connection depends on the availability of input jacks on your video monitor.

##### VIDEO jacks

For conventional composite video signals transmitted via composite video cables.

##### S VIDEO jacks

For S-video signals, separated into the luminance (Y) and chrominance (C) video signals transmitted on separate wires of S-video cables.

##### COMPONENT VIDEO jacks

For component video signals, separated into the luminance (Y) and chrominance (P<sub>B</sub>, P<sub>R</sub>) video signals transmitted on separate wires of component video cables.



This unit is equipped with the video conversion function. See pages 17 and 81 for details.

## Information on HDMI™

### ■ HDMI compatibility with this unit

Audio signal types	Audio signal formats	Compatible HDMI components
2ch Linear PCM	2ch, 32-192 kHz, 16/20/24 bit	CD, DVD-Video, DVD-Audio, etc.
Multi-ch Linear PCM	8ch, 32-192 kHz, 16/20/24 bit	DVD-Audio, etc.
DSD	2/5.1ch, 2.8224 MHz, 1 bit	SACD, etc.
Bitstream	Dolby Digital, DTS	DVD-Video, etc.

This unit's HDMI interface is based on the following standards:

- HDMI Version 1.2a (High-Definition Multimedia Interface Specification Version 1.2a) licensed by HDMI Licensing, LLC.
- HDCP Revision 1.1 (High-bandwidth Digital Content Protection System Revision 1.1) licensed by Digital Content Protection, LLC.

#### Notes

- When CPPM copy-protected DVD audio is played back, video and audio signals may not be output depending on the type of the DVD player.
- This unit is not compatible with HDCP-incompatible HDMI or DVI components.
- You can check the potential problem about the HDMI connection (see page 41).

### ■ HDMI jack and cable plug

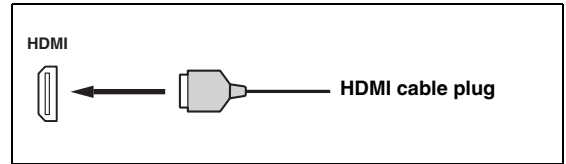

- We recommend using an HDMI cable shorter than 5 meters (16 feet) with the HDMI logo printed on it.
- Use a conversion cable (HDMI jack ↔ DVI-D jack) to connect this unit to other DVI components.

#### Notes

- Do not disconnect or connect the cable or turn off the power of the HDMI components connected to the HDMI OUT jack of this unit while data is being transferred. Doing so may disrupt playback or cause noise.
- Audio signals input at input jacks other than the HDMI IN 1 or HDMI IN 2 jack of this unit cannot be digitally output at the HDMI OUT jack.
- If you turn off the power of the video monitor connected to the HDMI OUT jack via a DVI connection, this unit may fail to establish the connection to the component.

## Audio and video signal flow

### Audio signal flow

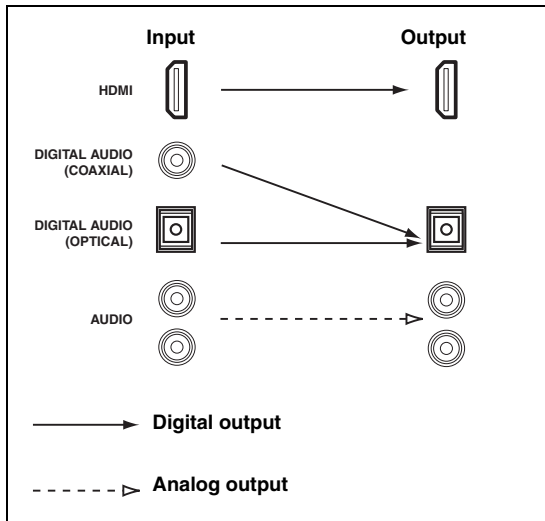

#### Notes

- 2-channel as well as multi-channel PCM, Dolby Digital and DTS signals input at the HDMI IN 1 or HDMI IN 2 jack can be output at the HDMI OUT jack only when "SUPPORT AUDIO" is set to "OTHER" (see page 77).
- Audio signals input at the HDMI IN jacks are not output at the AUDIO output and DIGITAL OUTPUT jacks.

### Video signal flow

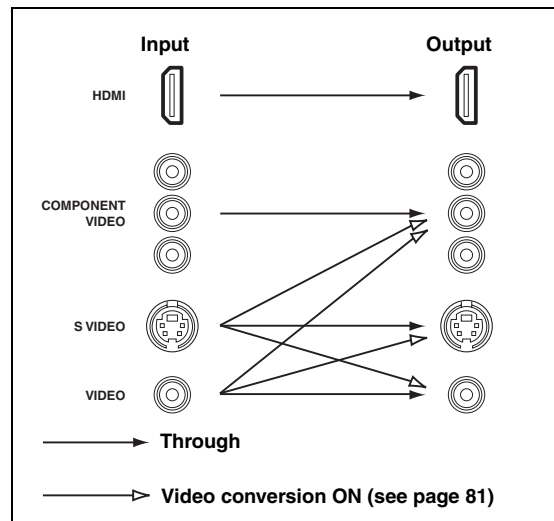

#### Notes

- When the analog video signals are input at the COMPONENT VIDEO, S VIDEO and VIDEO jacks, the priority order of the input signals is as follows:
  1. COMPONENT VIDEO
  2. S VIDEO
  3. VIDEO
- Digital video signals input at the HDMI IN 1 or HDMI IN 2 jack cannot be output from analog video output jacks.
- This unit does not accept analog component video signals with 1080p of resolution.
- The OSD signal is not output at the VCR OUT, DVR OUT and HDMI MONITOR OUT jacks and is not recorded.
- This unit does not deinterlace any analog video signals.

## Connecting a TV monitor or projector

Connect your TV (or projector) to the HDMI OUT jack, the COMPONENT VIDEO MONITOR OUT jacks, the S VIDEO MONITOR OUT jack or the VIDEO MONITOR OUT jack of this unit.



Make sure that this unit and other components are unplugged from the AC wall outlets.



You can choose to play back HDMI audio signals on this unit or on another HDMI component connected to the HDMI OUT jack of this unit. Use the "SUPPORT AUDIO" parameter in "SOUND MENU" to select the component to play back HDMI audio signals (see page 77).

### Notes

- Some video monitors connected to this unit via a DVI connection fail to recognize the HDMI audio/video signals being input if they are in the standby mode. In this case, the HDMI indicator flashes irregularly.
- When you connect your TV monitor or projector via HDMI connection, the OSD does not appear. In such cases, connect the TV monitor or projector via component, S-video or video connection.
- Connect the input source components to the HDMI IN 1 or HDMI IN 2 jack to display the video images on the video monitor connected to the HDMI OUT jack.

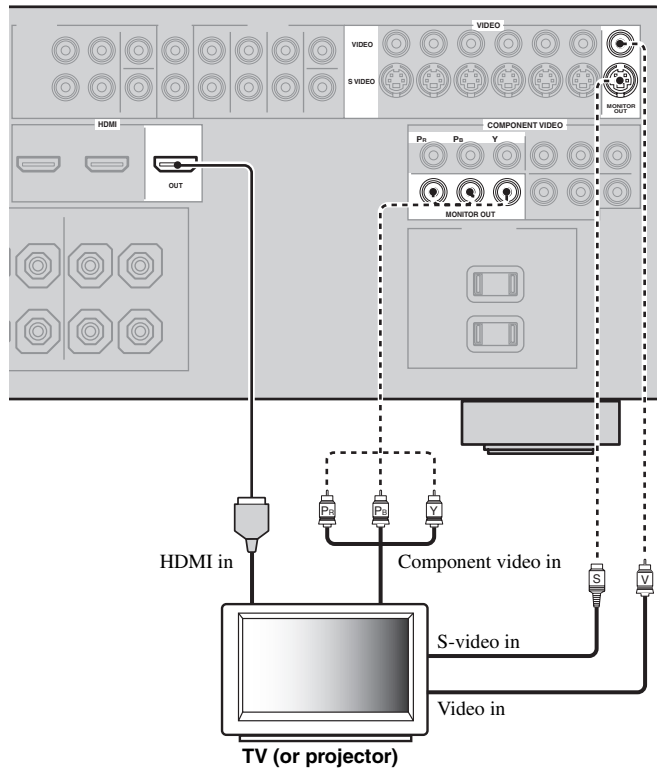

———— indicates recommended connections  
 - - - - - indicates alternative connections

## Connecting other components



Make sure that this unit and other components are unplugged from the AC wall outlets.

### Notes

- When “VIDEO CONV.” is set to “OFF” (see page 81), be sure to make the same type of video connections as those made for your TV (see page 18). For example, if you connected your TV to the VIDEO MONITOR OUT jack of this unit, connect your other components to the VIDEO jacks.

### ■ Connecting a DVD player

- When “VIDEO CONV.” is set to “ON” (see page 81), the converted video signals are output only at the MONITOR OUT jacks. To record a source, make the same type of video connections between each component.
- To make a digital connection to a component other than the default component assigned to each DIGITAL INPUT or DIGITAL OUTPUT jack, select the corresponding setting for “OPTICAL OUT”, “OPTICAL IN”, or “COAXIAL IN” in “I/O ASSIGNMENT” (see page 78).
- If you connect your DVD player to both the DIGITAL INPUT (OPTICAL) and the DIGITAL INPUT (COAXIAL) jacks, priority is given to the signals input at the DIGITAL INPUT (COAXIAL) jack.

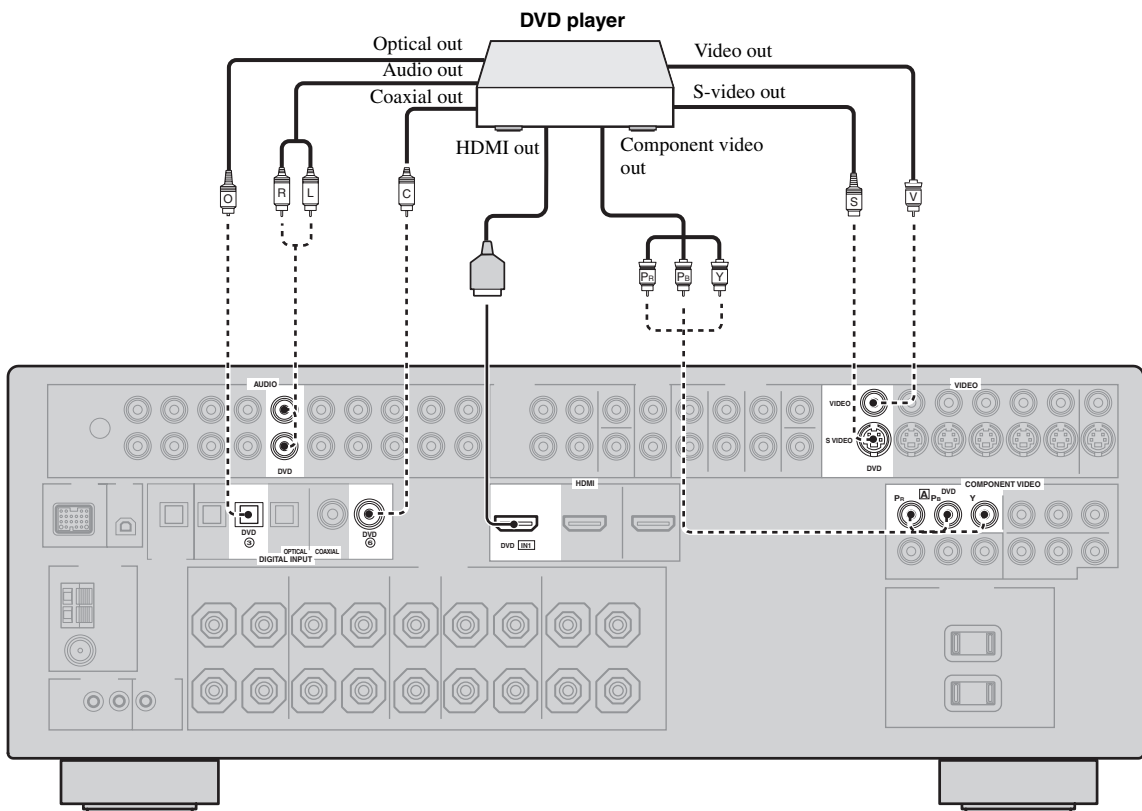

———— indicates recommended connections

- - - - - indicates alternative connections

■ Connecting a DVD recorder, PVR or VCR

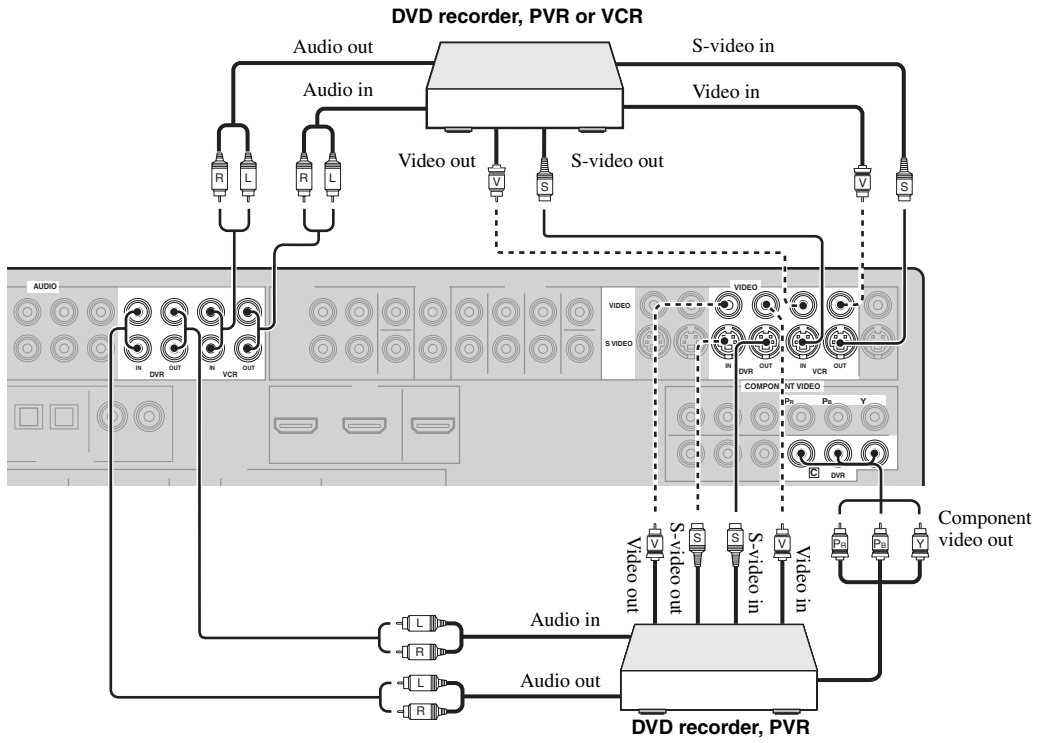

■ Connecting a set-top box

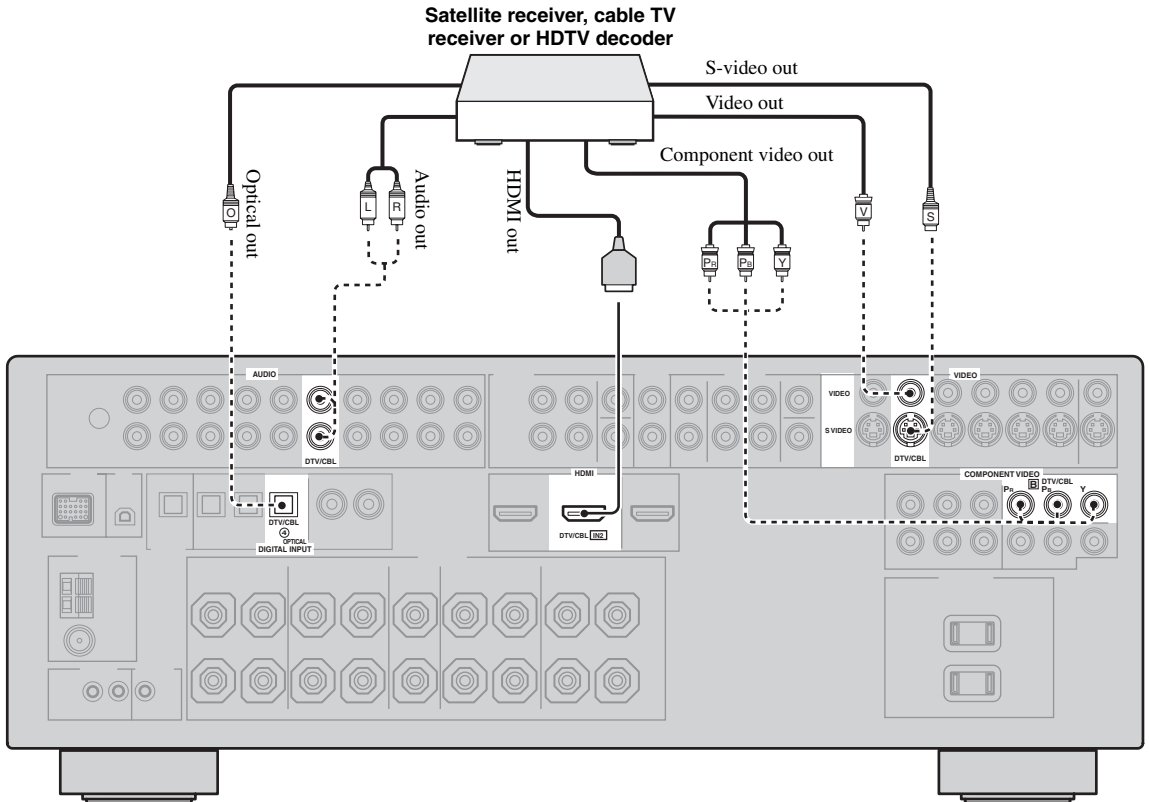



## ■ Connecting audio components

### Notes

- To make a digital connection to a component other than the default component assigned to each the DIGITAL INPUT jack or the DIGITAL OUTPUT jack, select the corresponding setting for “OPTICAL OUT”, “OPTICAL IN”, or “COAXIAL IN” in “I/O ASSIGNMENT” (see page 78).
- Connect your turntable to the GND terminal of this unit to reduce noise in the signal. However, you may hear less noise without the connection to the GND terminal for some turntables.
- The PHONO jacks are only compatible with a turntable with an MM or a high-output MC cartridge. To connect a turntable with a low-output MC cartridge to the PHONO jacks, use an in-line boosting transformer or an MC-head amplifier.
- When you connect both the DIGITAL INPUT (OPTICAL) jack and the DIGITAL INPUT (COAXIAL) jack to an audio component, the priority is given to the DIGITAL INPUT (COAXIAL) jack.

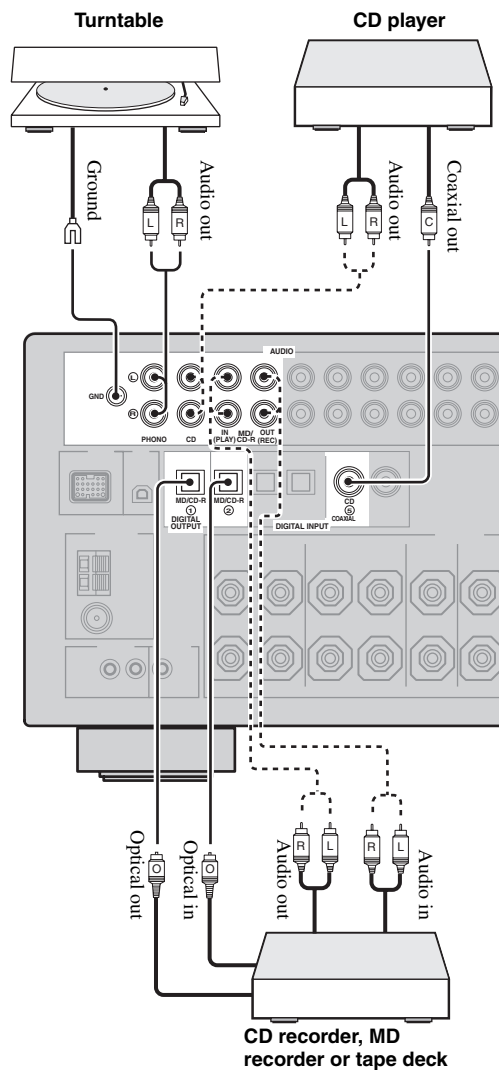

———— indicates recommended connections  
 - - - - - indicates alternative connections

## ■ Connecting an external amplifier

This unit has more than enough power for any home use. However, if you want to add more power to the speaker output or if you want to use another amplifier, connect an external amplifier to the PRE OUT jacks.

### Notes

- When you make connections to the PRE OUT jacks, do not make connections to the SPEAKERS terminals.
- The signals output at the FRONT PRE OUT jacks are affected by the TONE CONTROL settings (see page 48).
- Each PRE OUT jack outputs the same channel signals as the corresponding SPEAKERS terminals.
- Adjust the volume level of the subwoofer with the control on the subwoofer (see page 48).
- Some signals may not be output at the SUBWOOFER PRE OUT jack depending on the settings for “SPEAKER SET” (see page 72) and “LFE/BASS OUT” (see page 72).

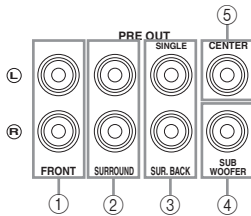

#### ① FRONT PRE OUT jacks

Front channel output jacks.

#### ② SURROUND PRE OUT jacks

Surround channel output jacks.

#### ③ SUR.BACK PRE OUT jacks

Surround back channel output jacks. When you only connect one external amplifier for the surround back channel, connect it to the SINGLE jack.

### Notes

- When “BI-AMP” is set to “ON”, this unit outputs the front channel audio signals at the SUR.BACK PRE OUT jacks.
- The audio signals output at the SUR.BACK PRE OUT jacks differ depending on the “EXTRA SP ASSIGN” setting (see page 72).

#### ④ SUBWOOFER PRE OUT jack

Connect a subwoofer with a built-in amplifier.

#### ⑤ CENTER PRE OUT jack

Center channel output jack.

## ■ Connecting a multi-format player or an external decoder

This unit is equipped with 6 additional input jacks (left and right FRONT, CENTER, left and right SURROUND and SUBWOOFER) for discrete multi-channel input from a multi-format player, external decoder, sound processor or pre-amplifier.

If you set “INPUT CH” to “8ch” in “MULTI CH SET” (see page 80), you can use the input jacks assigned as “FRONT” in “MULTI CH SET” (see page 80) together with the MULTI CH INPUT jacks to input 8-channel signals.

Connect the output jacks on your multi-format player or external decoder to the MULTI CH INPUT jacks. Be sure to match the left and right outputs to the left and right input jacks for the front and surround channels.

### Notes

- When you select the component connected to the MULTI CH INPUT jacks as the input source (see page 38), this unit automatically turns off the digital sound field processor, and you cannot select sound field programs.
- This unit does not redirect signals input at the MULTI CH INPUT jacks to accommodate for missing speakers. We recommend that you connect at least a 5.1-channel speaker system before using this feature.

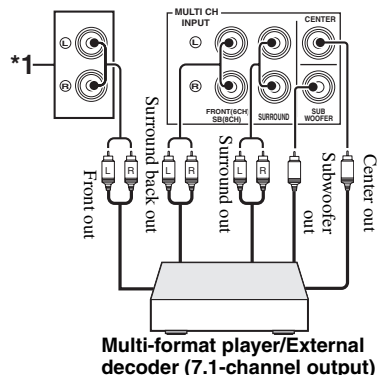
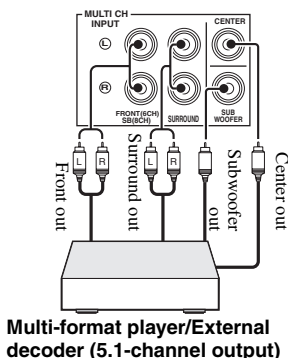

\*1 The analog audio input jacks assigned as “FRONT” in “MULTI CH SET” (see page 80).

## ■ Connecting a Yamaha iPod universal dock

This unit is equipped with the DOCK terminal on the rear panel that allows you to connect a Yamaha iPod universal dock (such as the YDS-10, sold separately) where you can station your iPod and control playback of your iPod using the supplied remote control. Connect a Yamaha iPod universal dock to the DOCK terminal on the rear panel of this unit using its dedicated cable.

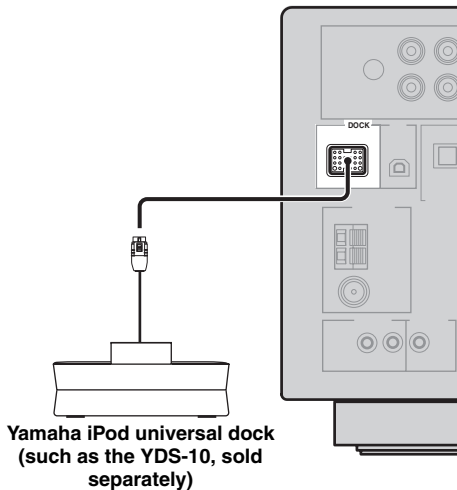

## ■ Using REMOTE IN/OUT jacks

When the components are the Yamaha products and have the capability of the transmission of the remote control signals, connect the REMOTE IN jack and REMOTE OUT jack to the remote control input and output jack with the monaural analog mini cable as follows.

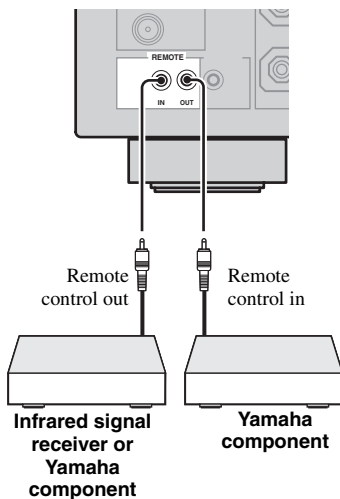

- If the components have the capability of the SCENE control signals, this unit can automatically activate the corresponding components and start the playback when you use one of the SCENE buttons. Refer to the owner's manuals for details about the capability of the SCENE control signals of the components.
- Connect the REMOTE OUT jack of this unit and the remote control input jack of the components to control the components by using the SCENE feature.
- If the component connected to the REMOTE OUT jack is not the Yamaha product, set "SCENE IR" in the advanced setup menu to "OFF" (see page 95).

## Using the VIDEO AUX jacks on the front panel

Use the VIDEO AUX jacks on the front panel to connect a game console or a video camera to this unit.

### Caution

Be sure to turn down the volume of this unit and other components before making connections.

### Notes

- The audio signals input at the DOCK terminal on the rear panel take priority over the ones input at the VIDEO AUX jacks.
- To reproduce the source signals input at these jacks, select "V-AUX" as the input source.

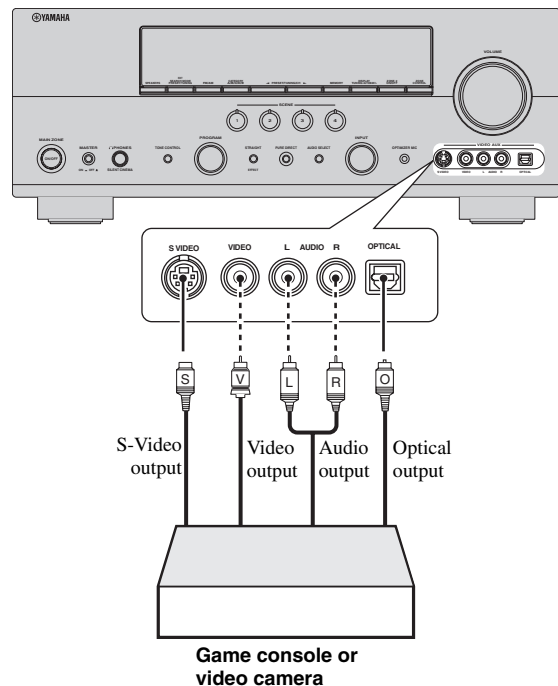

## Connecting the FM and AM antennas

Both FM and AM indoor antennas are supplied with this unit. Connect each antenna correctly to the designated terminals. In general, these antennas should provide sufficient signal strength.



See page 8 for connection information of the supplied indoor FM antenna and AM loop antenna.

### Notes

- The AM loop antenna should be placed away from this unit.
- The AM loop antenna should always be connected, even if an outdoor AM antenna is connected to this unit.
- A properly installed outdoor antenna provides clearer reception than an indoor one. If you experience poor reception quality, install an outdoor antenna. Consult the nearest authorized Yamaha dealer or service center about outdoor antennas.

### AM loop antenna (supplied)

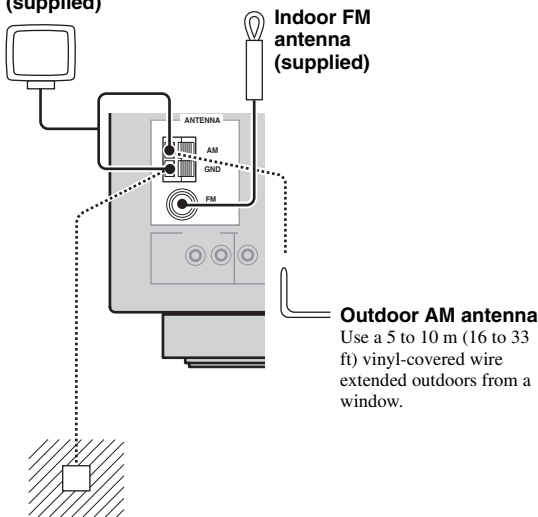

For maximum safety and minimum interference, connect the antenna GND terminal to a good earth ground. A good earth ground is a metal stake driven into moist earth.

## Connecting the power cable

(U.S.A. model)

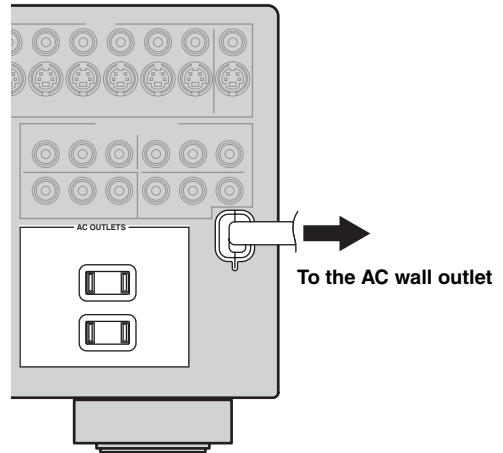

### AC OUTLET(S) (SWITCHED)

U.K. and Australia models.....	1 outlet
Korea model.....	None
Other models.....	2 outlets

Use these outlet(s) to supply power to any connected components. Connect the power cable of your other components to these outlet(s). Power to these outlet(s) is supplied when the main zone or Zone 2 is turned on. However, power to these outlet(s) is cut off when the main zone and Zone 2 are turned off or when **MASTER ON/OFF** on the front panel is pressed and released outward to the OFF position. For information on the maximum power or the total power consumption of the components that can be connected to these outlet(s), see "Specifications" on page 108.

### Memory back-up

The memory back-up circuit prevents the stored data from being lost even if this unit is in the standby mode. However, the stored data will be lost in case the power cable is disconnected from the AC wall outlet or if the power supply is cut off for more than one week.

## Setting the speaker impedance

### Caution

If you are to use 6 ohm speakers, set “SP IMP.” to “6Ω MIN” as follows BEFORE using this unit. 4 ohm speakers can be also used as the front speakers.

### 1 Make sure this unit is turned off.

Refer to the right column for details.

### 2 Press and hold ⑬ TONE CONTROL on the front panel and then press ⑫ MASTER ON/OFF inward to the ON position to turn on this unit.

This unit turns on, and the advanced setup menu appears in the front panel display.



### 3 Rotate the ⑭ PROGRAM selector on the front panel to select “SP IMP.”.

“SP IMP.” and the current speaker impedance setting (“8Ω MIN”) appear in the front panel display.

### 4 Press ⑬ TONE CONTROL on the front panel repeatedly to select “6Ω MIN”.

### 5 Press ⑫ MASTER ON/OFF on the front panel to release it outward to the OFF position to save the new setting and turn off this unit.

#### Note

The setting you made is reflected next time you turn on this unit.

## Turning this unit on and off

### ■ Turning on this unit

Press ⑫ **MASTER ON/OFF** on the front panel inward to the ON position to turn on this unit.

When you turn on this unit by pressing ⑫ **MASTER ON/OFF**, the main zone is turned on.



When you turn on this unit, there will be a 4 to 5-second delay before this unit can reproduce sound.

### ■ Turning off this unit

Press ⑫ **MASTER ON/OFF** on the front panel again to release it outward to the OFF position to turn off this unit.

#### Notes

- ⑪ **MAIN ZONE ON/OFF** on the front panel as well as ④ **POWER** and ⑥ **STANDBY** on the remote control are operational only when ⑫ **MASTER ON/OFF** is pressed inward to the ON position.
- As usual, we recommend using the standby mode to turn off this unit.

### ■ Set the main zone to the standby mode

Press ⑪ **MAIN ZONE ON/OFF** (or ⑥ **STANDBY**) to set the main zone to the standby mode.

In the standby mode, this unit consumes a small amount of power in order to receive infrared signals from the remote control.

### ■ Turning on the main zone from the standby mode

Press ⑪ **MAIN ZONE ON/OFF** (or ④ **POWER**) to turn on the main zone.



- You can also turn on the main zone by pressing ⑧ **SCENE** (or ⑦ **SCENE**) buttons.
- When you turn on this unit, there will be a 4 to 5-second delay before this unit can reproduce sound.
- These buttons are operational only when ⑫ **MASTER ON/OFF** is pressed inward to the ON position.

## Front panel display

### Note

The XM indicator is only applicable to the U.S.A. and Canada models and the cursor on the left of the XM indicator lights up only when “XM” is selected as the input source. For details, see “Basic XM Satellite Radio operations” on page 54.

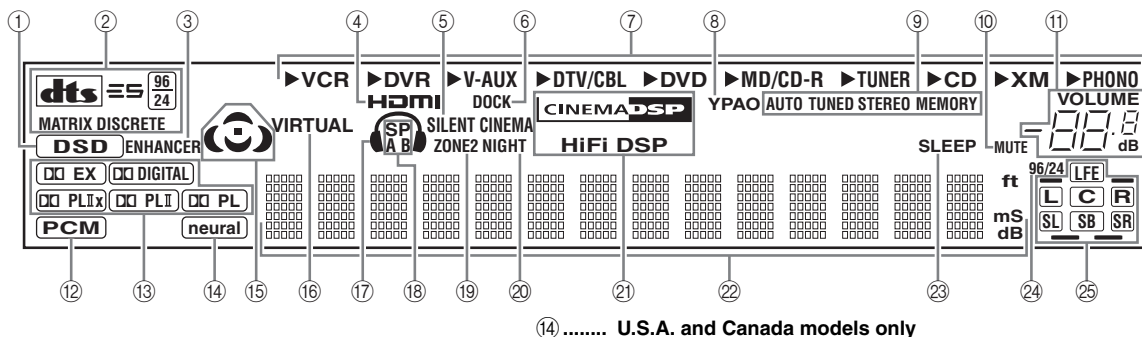

### ①⑫ Input signal indicators

Lights up when this unit is reproducing DSD (Direct Stream Digital) or PCM (Pulse Code Modulation) digital audio signals.

### ②⑬⑭ Decoder indicators

The respective indicator lights up when any of the decoders of this unit function.

### ③ ENHANCER indicator

Lights up when the Compressed Music Enhancer mode is selected (see page 46).

### ④ HDMI indicator

Lights up when the signal of the selected input source is input at HDMI IN 1 or HDMI IN 2 jacks (see page 16).

### ⑤ SILENT CINEMA indicator

Lights up when headphones are connected and a sound field program is selected (see page 46).

### ⑥ DOCK indicator

Lights up when you station your iPod in a Yamaha iPod universal dock (such as the YDS-10, sold separately) connected to the DOCK terminal of this unit (see page 23) and V-AUX is selected as the input source. The DOCK indicator also lights up when this unit is charging the battery of the stationed iPod in the standby mode.

### ⑦ Input source indicators

The corresponding cursor lights up to show the currently selected input source.

### ⑧ YPAO indicator

Lights up when you run “AUTO SETUP” and when the speaker settings set in “AUTO SETUP” are used without any modifications (see page 28).

### ⑨ Tuner indicators

Lights up when this unit is in the FM, AM or XM Satellite Radio tuning mode (see pages 50 to 57).

### ⑩ MUTE indicator

Flashes while the MUTE function is on (see page 40).

### ⑪ VOLUME level indicator

Indicates the current volume level.

### ⑮ Sound field indicators

Light up to indicate the active DSP sound fields.

### ⑯ VIRTUAL indicator

Lights up when Virtual CINEMA DSP is active (see page 46).

### ⑰ Headphones indicator

Lights up when headphones are connected (see page 40).

### ⑱ SP A B indicators

Light up according to the set of front speakers selected.

### ⑲ ZONE2 indicator

Lights up when Zone 2 is turned on (see page 90).

### ⑳ NIGHT indicator

Lights up when you select a night listening mode (see page 49).

### ㉑ DSP indicators

The respective indicator lights up when any of the DSP sound field programs are selected (see page 42).

**㉔ Multi-information display**

Shows the name of the current sound field program and other information when adjusting or changing settings.

**㉕ SLEEP indicator**

Lights up while the sleep timer is on (see page 41).

**㉖ 96/24 indicator**

Lights up when a DTS 96/24 signal is input to this unit.

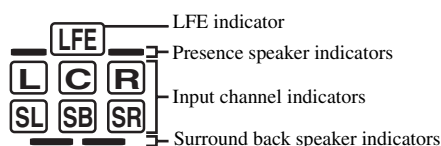
**㉗ Input channel and speaker indicators****LFE indicator**

Lights up when the input signal contains the LFE signal.

**Input channel indicators**

Indicate the channel components of the current digital input signal.

**Presence and surround back speaker indicators**

Light up according to the number of presence and surround back speakers set for “EXTRA SP ASSIGN” (see page 72) and “SB L/R SP” (see page 73) in “SOUND MENU” when this unit is in the auto setup (see page 28) or the speaker level setting in “SOUND MENU” (see page 74) procedure.



- You can make settings for surround back speakers automatically by running “AUTO SETUP” (see page 28) or manually by adjusting settings for “SB L/R SP” (see page 73) in “SOUND MENU”.
- To use the presence speakers, set “EXTRA SP ASSIGN” to “PRESENCE” (see pages 29 or 72).

**Using the remote control**

The remote control transmits a directional infrared ray. Be sure to aim the remote control directly at the remote control sensor on this unit during operation.

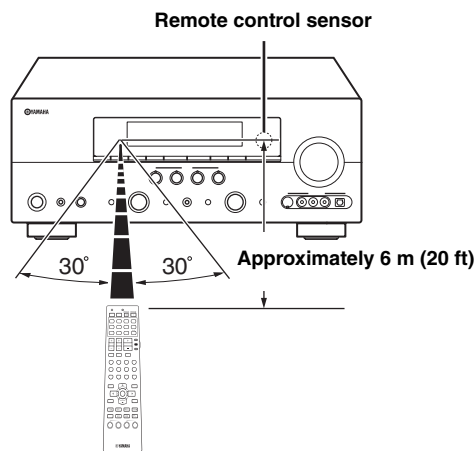
**Infrared window (W)**

Outputs infrared control signals. Aim this window at the component you want to operate.

**Ⓧ TRANSMIT indicator**

Flashes while the remote control is sending infrared signals.

**Operation mode selector (K)**

The function of some buttons depends on the operation mode selector position.

**AMP**

Operates the amplifier function of this unit.

**SOURCE**

Operates the component selected with an input selector button (see page 86).

**TV**

Operates the TV assigned to either DTV/CBL or PHONO (see page 85).

**Notes**

- Do not spill water or other liquids on the remote control.
- Do not drop the remote control.
- Do not leave or store the remote control in the following types of conditions:
  - places of high humidity, such as near a bath
  - places of high temperatures, such as near a heater or stove
  - places of extremely low temperatures
  - dusty places
- To set the remote control codes for other components, see page 87.

# Optimizing the speaker setting for your listening room

This unit employs the YPAO (Yamaha Parametric Room Acoustic Optimizer) technology which lets you avoid troublesome listening-based speaker setup and achieves highly accurate sound adjustments automatically. The supplied optimizer microphone collects and this unit analyzes the sound your speakers produce in your actual listening environment.

## Using AUTO SETUP

### Notes

- Be advised that it is normal for loud test tones to be output during the “AUTO SETUP” procedure.
  - To achieve the best results, make sure the room is as quiet as possible while the “AUTO SETUP” procedure is in progress. If there is too much ambient noise, the results may not be satisfactory.
- ☀
- You can run “AUTO SETUP” using the system menu that appears in the OSD or in the front panel display. This manual uses the OSD illustrations to explain the “AUTO SETUP” procedure.
  - Before performing operations, set the operation mode selector on the remote control to **AMP**.
  - This unit uses the speakers connected to the FRONT A speaker terminals as the front speakers for the adjustment.

### 1 Make sure of the following check points before starting the AUTO SETUP operations.

- Speakers are connected appropriately.
- Headphones are disconnected from this unit.
- This unit and the video monitor are turned on.
- The connected subwoofer is turned on and the volume level is set to about half way (or slightly less).
- The crossover frequency controls of the connected subwoofer is set to the maximum.
- The room is sufficiently quiet.

### 2 Connect the supplied optimizer microphone to the OPTIMIZER MIC jack on the front panel.

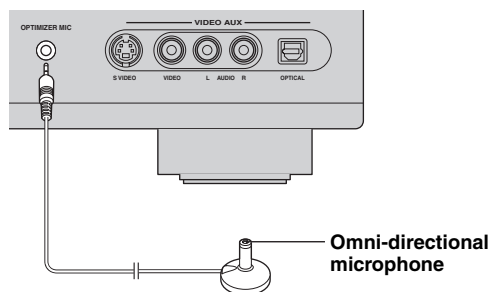

The following menu screen appears on the video monitor.

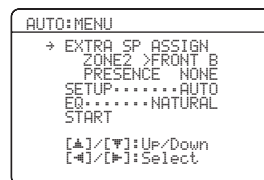

### 3 Place the optimizer microphone at your normal listening position on a flat level surface with the omni-directional microphone heading upward.

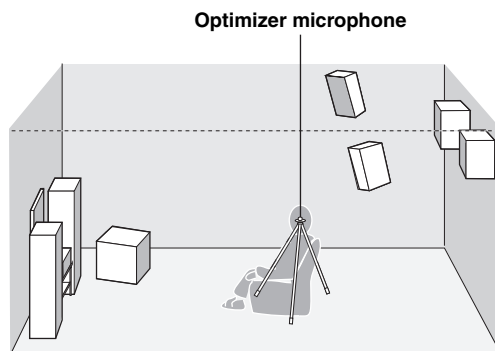

It is recommended that you use a tripod (etc.) to affix the optimizer microphone at the same height as your ears would be when you are seated in your listening position. You can use the attached screw of a tripod (etc.) to fix the optimizer microphone to the tripod (etc.).



- 4 Press **⓪** < / > to select the desired setting for “EXTRA SP ASSIGN” and then press **⓪** ▽.

#### Extra speaker assignment

EXTRA SP ASSIGN

Selects the function of the speakers connected to the EXTRA SP terminals.

Choices: **FRONT B**, ZONE2, PRESENCE, NONE

- **When you use the alternative front speaker system (see page 38)**  
Select “FRONT B”.
- **When you use the Zone 2 speakers (see page 90)**  
Select “ZONE2” to set the function of the speakers to the Zone 2 speakers. This unit drives the Zone 2 speakers by using the internal amplifier.
- **When you use the presence speakers (see page 12)**  
Select “PRESENCE” to set the function of the speakers to the presence speakers.
- **When you do not use the EXTRA SP terminals**  
Select “NONE” to deactivate the EXTRA SP terminals.

#### Note

If you select “ON” in “BI-AMP” (see page 95), you cannot select “PRESENCE” or “ZONE2” in “EXTRA SP ASSIGN”.

- 5 Press **⓪** < / > to select “SETUP”.

Choices: **AUTO**, RELOAD, UNDO, DEFAULT

- Select “AUTO” to automatically run the entire “AUTO SETUP” procedure.
- Select “RELOAD” to reload the last “AUTO SETUP” settings and override the previous settings.
- Select “UNDO” to undo the last “AUTO SETUP” settings and restore the previous settings.
- Select “DEFAULT” to reset the “AUTO SETUP” parameters to the initial factory settings.

#### Notes

- “RELOAD” or “UNDO” is available only when you have previously run “AUTO SETUP” and confirmed the results.
- “RELOAD” or “UNDO” is not available when you change the setting of “BI-AMP” in the advanced setup (see page 95) or “EXTRA SP ASSIGN” in “SOUND MENU” (see page 72).

- 6 Press **⓪** < / > to select the desired setting of “EQ” and then press **⓪** ▽.

#### Parametric equalizer type EQ

Parametric equalizer adjusts the level of the specified frequency bands. This unit automatically selects the crucial frequency bands for the listening room and adjusts the level of the selected frequency bands to create a cohesive sound field in the room. You can select the type of the parametric equalizer adjustment from the following choices.

Choices: **NATURAL**, FLAT, FRONT

- Select “NATURAL” to average out the frequency response of all speakers with higher frequencies being less emphasized. Recommended if the FLAT setting sounds a little harsh.
- Select “FLAT” to average the frequency response of all speakers. Recommended if all of your speakers are of similar quality.
- Select “FRONT” to adjust the frequency response of each speaker in accordance with the sound of your front speakers. Recommended if your front speakers are of much higher quality than your other speakers.

- 7 Press **⓪** ▽ to select “START” and then press **⓪** ENTER to start the setup procedure.

This unit starts the auto setup procedure. Loud test tones are output from each speaker during the auto setup procedure. Once all items are set, the “AUTO:RESULT” display appears in the OSD.

#### Notes

- During the auto setup procedure, do not perform any operation on this unit.
- We recommend getting out of the room while this unit is in the auto setup procedure. It takes approximately 3 minutes for this unit to complete the auto setup procedure.

This unit performs the following checks:

**Speaker wiring** WIRING

Checks which speakers are connected and the polarity of each speaker.

**Speaker size** SIZE

Checks the frequency response of each speaker and sets the appropriate low-frequency crossover for each channel.

**Speaker distance** DISTANCE

Checks the distance of each speaker from the listening position and adjusts the timing of each channel.

**Equalizing** EQUALIZING

Checks and adjusts the tonal characteristics of all the speakers by the setting of “EQ”.

**Speaker level** LEVEL

Checks and adjusts the volume level of each speaker.

The display changes as follows.

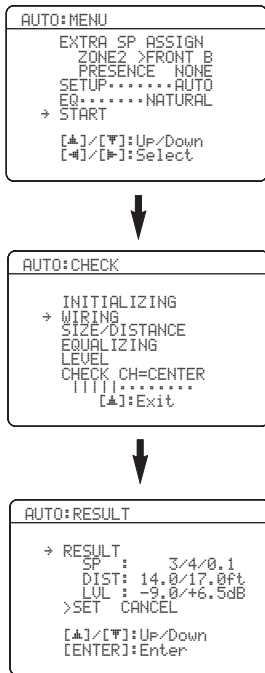

The results displayed under “RESULT” are as follows.

**Number of speakers** SP

Displays the number of speakers connected to this unit in the following order:  
Front/Back/Subwoofer

**Speaker distance** DIST

Displays the speaker distance from the listening position in the following order:  
Closest speaker distance/Farthest speaker distance

**Speaker level** LUL

Displays the speaker output level in the following order:  
Lowest speaker output level/Highest speaker output level

**Notes**

- If “E-10:INTERNAL ERROR” appears during the testing procedure, restart from step 4.
- If you selected “RELOAD” in step 4, no test tones are output.
- If an error occurs during the “AUTO:CHECK” procedure, the setup procedure is canceled and an error screen appears. For details, see “If an error screen appears” on page 32.
- When this unit detects potential problems during the “AUTO SETUP” procedure, “WARNING” and the number of warning messages appears in the above of “RESULT” (see page 32).
- Depending on the listening environment, “SWFR PHASE:REV” appears during the “AUTO:CHECK” procedure and “SUBWOOFER PHASE” in “SOUND MENU” (see page 74) is automatically set to “REVERSE”.

**8 Press ENTER to display the setup results in detail.**

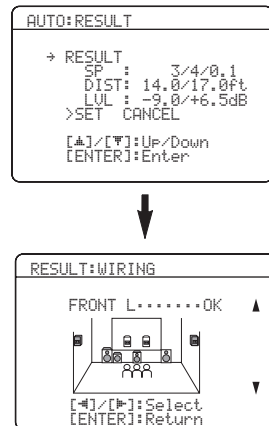

9 Press **Ⓢ** < / > repeatedly to toggle between the setup result displays.

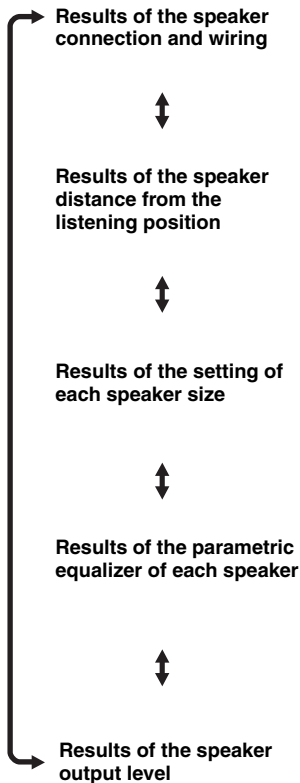

If you are not satisfied with the results or want to manually adjust each parameter, run “MANUAL SETUP” (see page 69).

**Notes**

- The distances displayed in the “DISTANCE” results may be longer than the actual distance depending on the characteristics of your subwoofer.
- In the “EQ” results, different values may be set for the same frequency to provide finer adjustments.

10 Press **Ⓢ** **ENTER** to return to the top “AUTO:RESULT” display.

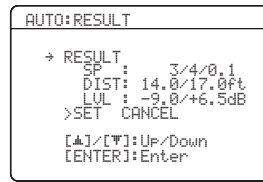

11 Make sure the pointer is pointing at “SET” and “CANCEL” and then press **Ⓢ** < / > to select “SET” or “CANCEL”.

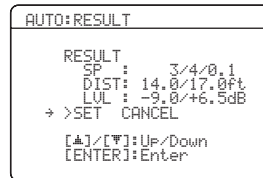

Choices: **SET**, **CANCEL**

- Select “SET” to confirm the “AUTO SETUP” results.
- Select “CANCEL” to cancel the “AUTO SETUP” results.

12 Press **Ⓢ** **ENTER** to confirm your selection. The top “SET MENU” display appears in the OSD.

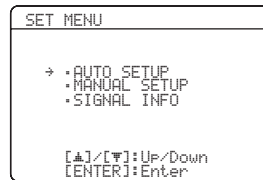

13 Press **Ⓢ** **SET MENU** to exit from “SET MENU”.

14 Disconnect the optimizer microphone from this unit.

The optimizer microphone is sensitive to heat. Keep it away from direct sunlight and do not place it on top of this unit.



If you change speakers, speaker positions, or the layout of your listening environment, run “AUTO SETUP” again to recalibrate your system.

## ■ If an error screen appears

Press **Ⓔ** / **⬆** / **⬇** / **⬅** / **➡** to select “RETRY” or “EXIT” and then press **ⒺENTER**.

The following display is an example where “E-9:USER CANCEL” appears in the OSD.

```
AUTO:ERROR
→ E-9:USER CANCEL
  Don't operate
  any function.

>RETRY EXIT

[⬆]/[⬇]:Select
[ENTER]:Enter
```

Choices: **RETRY**, **EXIT**

- Select “RETRY” to retry the “AUTO SETUP” procedure.
- Select “EXIT” to exit from the “AUTO SETUP” procedure.

## ■ If “WARNING” appears

When this unit detects potential problems during the “AUTO SETUP” procedure, “WARNING” appears in the “AUTO:RESULT” display. Check the warning messages to correct your speaker settings.

### Note

Warnings differ from errors in that warnings do not cancel the “AUTO SETUP” procedure.

## 1 Make sure the pointer is pointing at “WARNING” and then press **ⒺENTER** to display the detailed information about the warning.

The number on the right of “WARNING” indicates the number of warning messages.

```
AUTO:RESULT
→ WARNING(3)
  RESULT
  SP : 3/4/0.1
  DIST: 14.0/17.0ft
  LVL : -9.0/+6.5dB
>SET CANCEL

[⬆]/[⬇]:Up/Down
[ENTER]:Enter
```

## 2 Press **Ⓔ** / **⬅** / **➡** repeatedly to toggle between the warning displays.

```
WARNING:W-1
<OUT OF PHASE>
Reverse Channel
FL --
CENTER --
PL PR
SL CR
SBL SBR
[⬆]/[⬇]:Select
[ENTER]:Return
```



- For details about each warning message, see the “AUTO SETUP” section in “Troubleshooting” on page 101.
- When the corresponding warning message is not applicable to a speaker, “--” is displayed instead.

## 3 Press **ⒺENTER** to return to the top “AUTO:RESULT” display.

# Selecting the SCENE templates

This unit is equipped with 18 preset SCENE templates for various situations of using this unit. As the initial factory setting, the following SCENE templates are assigned to each SCENE button:

- SCENE 1:** DVD Viewing
- SCENE 2:** Disc Listening
- SCENE 3:** TV Viewing
- SCENE 4:** Radio Listening

If you want to use other SCENE templates, you can select the desired SCENE templates from the SCENE template library and assign the templates to the selected SCENE buttons on the front panel and the remote control.

Select the desired SCENE template

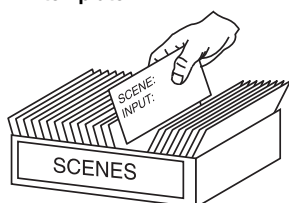

SCENE template library (Image)



Assign the SCENE template to the SCENE button

## Selecting the desired SCENE template

- 1 Press and hold the **Ⓜ** SCENE (or **Ⓧ** SCENE) button for 3 seconds.**

The indicator on the selected SCENE button on the front panel starts to flash, and the name of the currently assigned SCENE template appears in the front panel display.

3 seconds



Front panel

or

3 seconds



Remote control



Flashes

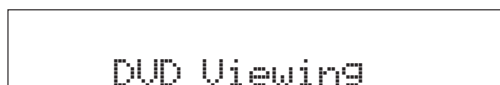

- 2 Rotate the **Ⓜ** INPUT selector (or set the operation mode selector to **Ⓚ** AMP and then press **Ⓜ** </>) to select the desired template.**



- 3 Press the **Ⓜ** SCENE (or **Ⓧ** SCENE) button again to confirm the selection.**

The selected SCENE template is assigned to the SCENE button.



Front panel

or



Remote control

### Notes

- If you do not carry out any operation within 30 seconds from the last operation in these steps, this procedure is automatically canceled.
- Once the desired SCENE templates are assigned to the corresponding SCENE buttons, you need to set the input source of the SCENE template on the remote control. See page 84 for details.



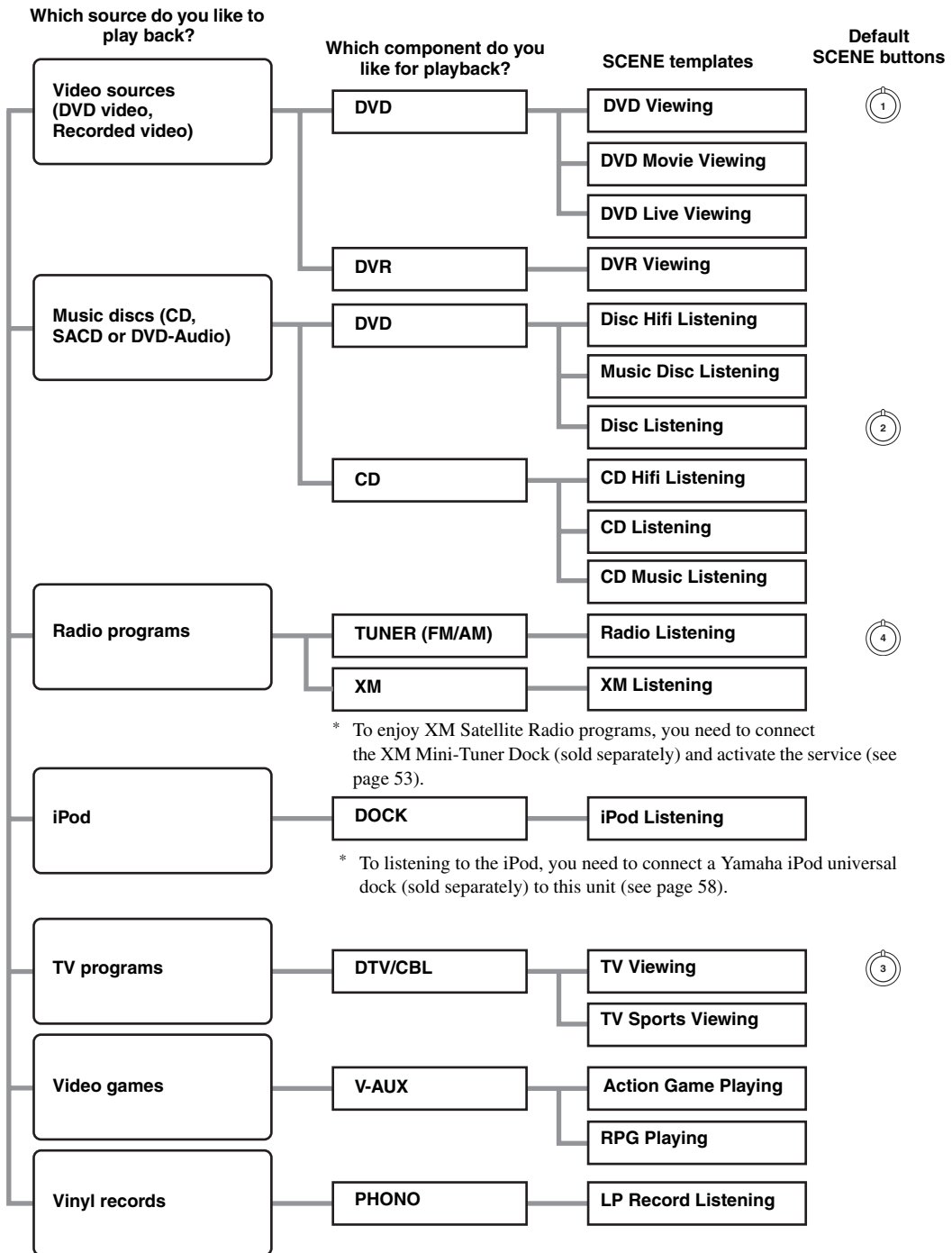

■ Which SCENE template would you like to select?



You can create your original SCENE templates by editing the preset SCENE templates. See page 36 for details.

## ■ Preset SCENE templates descriptions

The illustrations of the SCENE button in the following table indicate the assigned SCENE buttons as the default setting.

SCENE template	Input source	Playback mode	Features
DVD Viewing 	DVD*1	STRAIGHT	Select this SCENE template when you play back general contents on the DVD player.
DVD Movie Viewing	DVD*1	MOVIE Sci-Fi	Select this SCENE template when you play back movies on your DVD player.
DVD Live Viewing	DVD*1	ENTERTAINMENT Music Video	Select this SCENE template when you enjoy the music live video on your DVD player.
DVR Viewing	DVR	MOVIE Drama	Select this SCENE template when you play back movies on your digital video recorder.
Disc Hifi Listening	DVD*1	PURE DIRECT	Select this SCENE template when you enjoy the high fidelity sound of the music discs on your DVD player.
Music Disc Listening	DVD*1	STEREO 2ch STEREO	Select this SCENE template when you play back music discs on your DVD player.
Disc Listening 	DVD*1	STEREO 7ch STEREO	Select this SCENE template when you play back music sources on your DVD player as the background music.
CD Hifi Listening	CD*1	PURE DIRECT	Select this SCENE template when you enjoy the high fidelity sound of the music discs on your CD player.
CD Listening	CD*1	STEREO 2ch STEREO	Select this SCENE template when you play back music discs on your CD player.
CD Music Listening	CD*1	STEREO 7ch STEREO	Select this SCENE template when you play back music source on your CD player as the background music.
Radio Listening 	TUNER	MUSIC ENHANCER 7ch Enhancer	Select this SCENE template when you enjoy FM or AM radio programs.
XM Listening	XM	MUSIC ENHANCER 7ch Enhancer	Select this SCENE template when you enjoy XM Satellite Radio programs.
iPod Listening	DOCK (V-AUX)	MUSIC ENHANCER 7ch Enhancer	Select this SCENE template when you play back music on your iPod stationed in a Yamaha iPod universal dock.
TV Viewing 	DTV/CBL	STRAIGHT	Select this SCENE template when you enjoy general programs on your TV.
TV Sports Viewing	DTV/CBL	ENTERTAINMENT Sports	Select this SCENE template when you enjoy sports programs on your TV.
Action Game Playing	V-AUX*2	ENTERTAINMENT Action Game	Select this SCENE template when you play action games such as car racing and FPS games.
RPG Playing	V-AUX*2	ENTERTAINMENT Roleplaying Game	Select this SCENE template when you play role-playing games.
LP Record Listening	PHONO	PURE DIRECT	Select this SCENE template when you play back vinyl records on your turntable.

\*1 When the connected DVD player or CD player has the capability of the SCENE control signals and is connected to the REMOTE OUT jack of this unit, this unit operates the DVD player or CD player worked with the SCENE features.

\*2 You can select "V-AUX" as the input source even if your iPod is stationed in the Yamaha Universal Dock connected to this unit. When the SCENE mode is deactivated and your iPod is stationed in the Yamaha Universal Dock, this unit selects "DOCK" as the input source automatically.

## Creating your original SCENE templates

You can create your original SCENE templates for each SCENE button. You can refer to the preset 18 SCENE templates to create the original SCENE templates.

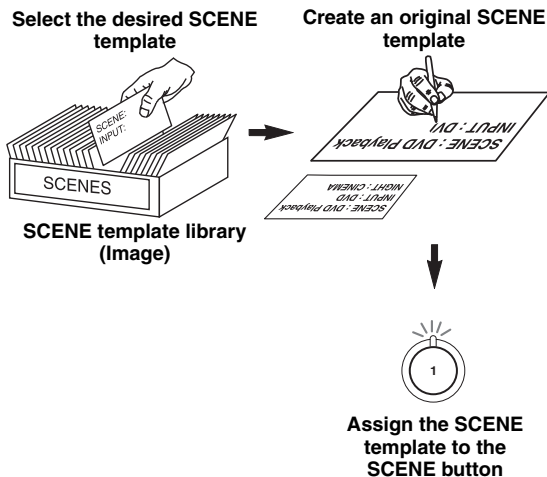

**1 Turn on the video monitor connected to this unit.**

**2 Set the operation mode selector to **AMP** and then press and hold the desired **SCENE** button for 3 seconds.**

The SCENE template customizing screen appears on the video monitor.

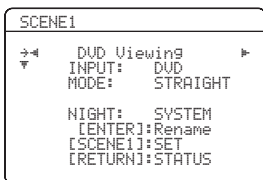

**Note**

When the SCENE template you want to customize is not assigned to any of the **SCENE** buttons, press **</>** repeatedly to recall the desired SCENE template on the menu screen.

**3 Press **</>** to select the desired parameter of the SCENE template and then **</>** to select the desired value of the selected parameter.**

You can adjust the following parameters for a SCENE template:

- **INPUT:** The input source component.
- **MODE:** The active sound field programs, STRAIGHT or Pure Direct mode.
- **NIGHT:** The night listening mode (see page 49).
  - **SYSTEM:** Keeps the current night listening mode.
  - **CINEMA:** Sets the night listening mode to the CINEMA mode.
  - **MUSIC:** Sets the night listening mode to the MUSIC mode.

**4 Press the **SCENE** button again to confirm the edit.**



An asterisk mark (\*) appears by the name of the original SCENE template.

**Notes**

- Once the desired SCENE templates are assigned to the corresponding **SCENE** buttons, you need to set the input source of the SCENE template on the remote control. See page 84 for details.
- You can create a customized SCENE template for each SCENE button, and if you create another customized SCENE template, this unit overwrites the old customized SCENE template with the new one.
- The newly created template is only available for the assigned SCENE button.

**Rename the SCENE templates**

Select the name of the SCENE template at step 3 of “Creating your original SCENE templates” and then press **ENTER**.

- Press **</>** to select the desired character.
- Press **</>** to place an “\_” (underscore) under the space or the desired character.
- Press **RETURN** to cancel the new name.
- Press **ENTER** to confirm the new name.



# Playback

## Caution

Extreme caution should be exercised when you play back CDs encoded in DTS. If you play back a CD encoded in DTS on a DTS-incompatible CD player, you will only hear some unwanted noise that may damage your speakers. Check whether your CD player supports CDs encoded in DTS. Also, check the sound output level of your CD player before you play back a CD encoded in DTS.



To play DTS-encoded CDs when using a digital audio connection, set "DECODER MODE" in "INPUT MENU" to "DTS" before the playback (see page 80).



Before performing operations, set the operation mode selector on the remote control to **AMP**.

## Basic procedure

### 1 Turn on the video monitor connected to this unit.



See page 40 to display the input source information.

### 2 Rotate the **INPUT** selector (or press one of the input selector buttons (A)) to select the desired input source.

The name of the currently selected input source appears in the front panel display for a few seconds.

Available input sources



Currently selected input source



The corresponding input selector button on the remote control for the currently selected input source lights up for approximately 5 seconds after you press any buttons on the remote control, showing which source component is currently being operated.

### 3 Start playback on the selected source component or select a broadcast station.

- Refer to the operating instructions for the source component.
- See page 50 for details about tuning instructions.
- See page 54 for details about XM Satellite Radio tuning instructions.

### 4 Rotate **VOLUME** (or press **VOLUME +/-**) to adjust the volume to the desired output level.



- See page 48 to adjust the level of each speaker.
- This does not affect the AUDIO OUT (REC) level.
- You can set the initial volume level and maximum volume level (see page 77).

### 5 Rotate the **PROGRAM** selector (or press one of the sound field program selector buttons (P) repeatedly) to select the desired sound field program.

The name of the selected sound field program appears in the front panel display. See page 42 for details about sound field programs.

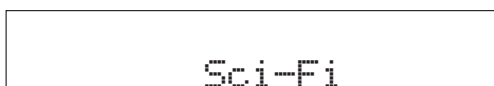

Currently selected sound field program

## Note

Sound field programs cannot be selected when the component connected to the MULTI CH INPUT jacks is selected as the input source (see page 38).



- Choose a sound field program based on your listening preference, not merely on the name of the program.
- When you select an input source, this unit automatically selects the last sound field program used with the corresponding input source.
- To display information about the currently selected sound field program in the OSD, see page 61 for details.

## ■ A quick guide to contents

When you want to...	See page
Enjoy pure hi-fi stereo sound	48
Adjust the tonal quality of the front speakers	48
Adjust the parameters of sound field programs	61
Enjoy sources with a wide dynamic range at night	49
Use headphones	40
Enjoy multi-channel sources in 2-channel stereo	49
Select a decoder to play back sources with	66
Automatically set this unit to the standby mode	41

## Selecting the MULTI CH INPUT component

Use this feature to select the component connected to the MULTI CH INPUT jacks (see page 22) as the input source.

Rotate the **Ⓜ** INPUT selector to select MULTI CH (or **Ⓐ** MULTI CH IN).

“MULTI CH” appears in the front panel display.



Use “MULTI CH SET” menu in “INPUT MENU” to set the parameters for MULTI CH INPUT (see page 80).

### Note

Sound field programs and the night listening mode cannot be selected when the component connected to the MULTI CH INPUT jacks is selected as the input source.

## Selecting the front speaker set

Use this feature to turn the front speaker system (FRONT A and/or FRONT B) on or off.

Press **①** **SPEAKERS** on the front panel repeatedly to turn on or off the set of front speakers connected to the FRONT A and/or EXTRA SP speaker terminals.

The active front speaker set changes as follows:

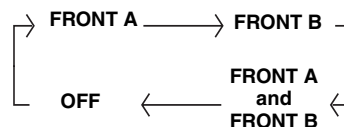

### Notes

- FRONT A and B or FRONT B setting is not available when “EXTRA SP ASSIGN” is set to “PRESENCE”, “ZONE 2” or “NONE” (see page 72).
- Turn off the volume level of this unit when you switch the front speaker setting.

## ■ Using the Zone B feature

When you set “FRONT B” to “ZONE B” (see page 72), you can use the speakers connected to the EXTRA SP speaker terminals in another room (Zone B).

Press **①** **SPEAKERS** on the front panel repeatedly to turn on or off the Zone B speakers.

When you activate the Zone B speakers, all the speakers in the main room are muted.

### Notes

- You cannot activate both the main room and Zone B speakers simultaneously.
- If you select CINEMA DSP sound field program and activate the Zone B speakers, Virtual CINEMA DSP activates automatically (see page 46).

## Selecting audio input jacks (AUDIO SELECT)

This unit comes with a variety of input jacks. Use this feature (audio input jack select) to switch between input jacks when more than one input jack is assigned to as the same input source.



- We recommend setting the audio input jack select to "AUTO" in most cases.
- You can adjust the default audio input jack select of this unit by using "AUDIO SELECT" in "OPTION MENU" (see page 82).

Press **Ⓜ** **AUDIO SELECT** (or **Ⓛ** **AUDIO SEL**) repeatedly to select the desired audio input jack select setting.

### Available input sources



### Currently selected audio input jack select setting

AUTO	Automatically selects input signals in the following order: (1) HDMI (2) Digital signals (3) Analog signals
HDMI	Selects only HDMI signals. When HDMI signals are not input, no sound is output.
COAX/OPT	Automatically selects input signals in the following order: (1) Digital signals input at the COAXIAL jack. (2) Digital signals input at the OPTICAL jack. When no signals are input, no sound is output.
ANALOG	Selects only analog signals. If no analog signals are input, no sound is output.

### Note

This feature is not available when no digital input jacks (OPTICAL, COAXIAL and HDMI) are assigned. In addition, HDMI is not available as an audio input jack select setting when the HDMI IN 1 and HDMI IN 2 jacks are not used. Use "I/O ASSIGNMENT" in "INPUT MENU" to reassign the respective input jack (see page 78).

## Displaying the current status of this unit on a video monitor

You can display the operating information of this unit on a video monitor.

- 1 Turn on the video monitor connected to this unit.
- 2 Set the operation mode selector to **Ⓜ** **AMP** and then press **Ⓜ** **DISPLAY** on the remote control.

The current status screen appears in the OSD.

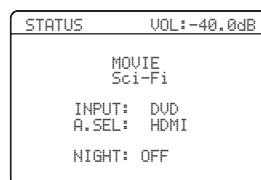

You can select the amount of time that the current status is displayed in the OSD by using the "OSD-AMP" parameter in "OPTION MENU" (see page 81).

### Note

The OSD signal is not output at the VIDEO output jacks and will not be recorded.

## Using your headphones

Connect a pair of headphones with a stereo analog audio cable plug to the PHONES jack on the front panel.

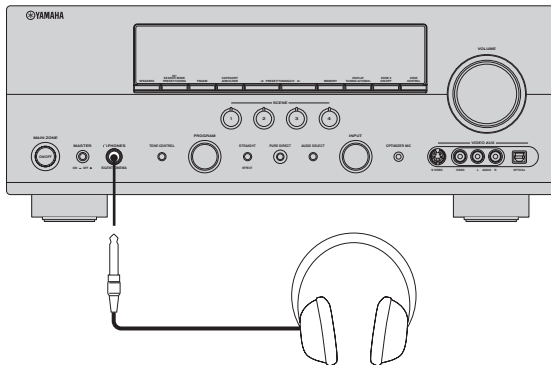

When you select a sound field program, SILENT CINEMA mode activates automatically (see page 46).

### Notes

- When you connect headphones, no signals are output at the speaker terminals.
- All Dolby Digital and DTS audio signals are mixed down to the left and right headphone channels.

## Muting the audio output

Press **MUTE** on the remote control to mute the audio output. Press **MUTE** again to resume the audio output.



- You can also rotate **VOLUME** on the front panel or press **VOLUME +/-** to resume the audio output.
- You can adjust the muting level by using the “MUTE TYPE” parameter in “SOUND MENU” (see page 76).
- The MUTE indicator flashes in the front panel display when the audio output is muted and disappears from the front panel display when the audio output is resumed.

## Playing video sources in the background of an audio source

You can combine a video image from a video source with sound from an audio source. For example, you can enjoy listening to classical music while viewing beautiful scenery from the video source on the video monitor.

Press the input selector buttons (A) on the remote control to select a video source and then an audio source.

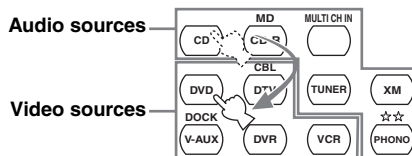

Set the “BGV” parameter in the “MULTI CH SET” menu to the desired setting to select the default background video input source of the MULTI CH INPUT sources (see page 80).

## Displaying the input source information

You can display the format, sampling frequency, channel, bit rate and flag data of the current input signal.

- 1 Set the operation mode selector to **AMP** and then press **SET MENU** on the remote control.

The top “SET MENU” display appears in the OSD.

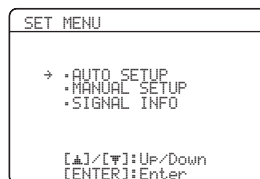

- 2 Press **DOWN** repeatedly to select “SIGNAL INFO” and then press **ENTER**.

The audio information about the input source appears in the OSD.

- 3 Press **LEFT/RIGHT** to toggle between the audio and video information displays.

- 4 Press **Ⓝ** **SET MENU** on the remote control again to exit from “SET MENU”.

### ■ Audio information

FORMAT	Signal format. When this unit cannot detect a digital signal, it automatically switches to analog input.
SAMPLING	The number of samples per second taken from a continuous signal to make a discrete signal.
CHANNEL	The number of source channels in the input signal (front/surround/LFE). For example, a multi-channel soundtrack with 3 front channels, 2 surround channels and LFE, is displayed as “3/2/0.1”.
BITRATE	The number of bits passing a given point per second.
FLAG	Flag data encoded in DTS, Dolby Digital, or PCM signals that cue this unit to automatically switch decoders.

#### Note

“...” appears when this unit cannot display the corresponding information.

### ■ Video information

HDMI RES.	Resolution of the HDMI signals input or output at the HDMI IN/OUT jacks of this unit.
HDMI ERROR	Error message for HDMI sources or connected HDMI devices. See page 101 for details.

## Using the sleep timer

Use this feature to automatically set the main zone to the standby mode after a certain amount of time. The sleep timer is useful when you are going to sleep while this unit is playing or recording a source. The sleep timer also automatically turns off any external components connected to the AC OUTLET(S) (see page 24).

Set the operation mode selector to **Ⓚ** **AMP** and then press **Ⓜ** **SLEEP** repeatedly to set the amount of time.

Each time you press **Ⓜ** **SLEEP**, the front panel display changes as shown below.

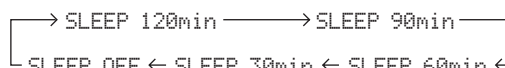

The SLEEP indicator flashes while you are switching the amount of time for the sleep timer. Once the sleep timer is set, the SLEEP indicator lights up in the front panel display, and the display returns to the selected sound field program.

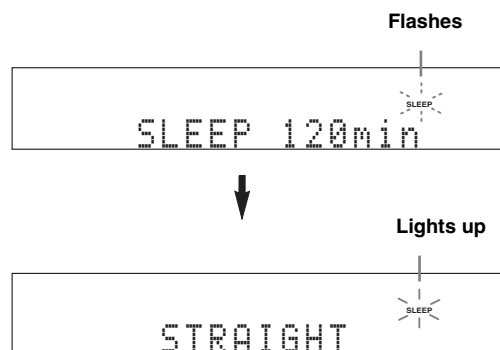

### ■ Canceling the sleep timer

Press **Ⓜ** **SLEEP** on the remote control repeatedly until “SLEEP OFF” appears in the front panel display.

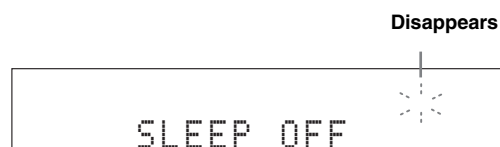

The SLEEP indicator turns off, and “SLEEP OFF” disappears from the front panel display after a few seconds.



The sleep timer setting can also be canceled by pressing **Ⓞ** **STANDBY** (or **Ⓜ** **MAIN ZONE ON/OFF**) to set the main zone to the standby mode.

# Sound field programs

This unit is equipped with a variety of precise digital decoders that allow you to enjoy multi-channel playback from almost any stereo or multi-channel sound source. This unit is also equipped with a Yamaha digital sound field processing (DSP) chip containing several sound field programs which you can use to enhance your playback experience.



- The Yamaha HiFi DSP sound field programs recreate real-world acoustic environments made from precise measurements taken in actual concert halls, music venues, movie theaters, etc. Thus, you may notice variations in the strength of the reflections coming from the front, back, left and right.
- You can change sound field parameters. See page 61 for details.

## Selecting sound field programs

Rotate the **⑭ PROGRAM** selector (or set the operation mode selector to **Ⓚ AMP** and then press one of the sound field selector buttons (**Ⓟ**) repeatedly).

The name of the selected sound field program appears in the front panel display and in the OSD.

### Notes

- When you select an input source, this unit automatically selects the last sound field program used with the corresponding input

source.

- Sound field programs cannot be selected when the component connected to the MULTI CH INPUT jacks is selected as the input source (see page 38).
- When you play back DTS 96/24 sources with any sound field program, this unit applies the selected program without activating the DTS 96/24 decoder.
- Sampling frequencies higher than 48 kHz are sampled down to 48 kHz or lower and then sound field programs are applied.
- When the sampling frequency of the input sources are higher than 96 kHz, this unit does not apply any sound field programs.

## Sound field program descriptions



Select a sound field program based on your listening preference, not merely on the name of the program, etc.

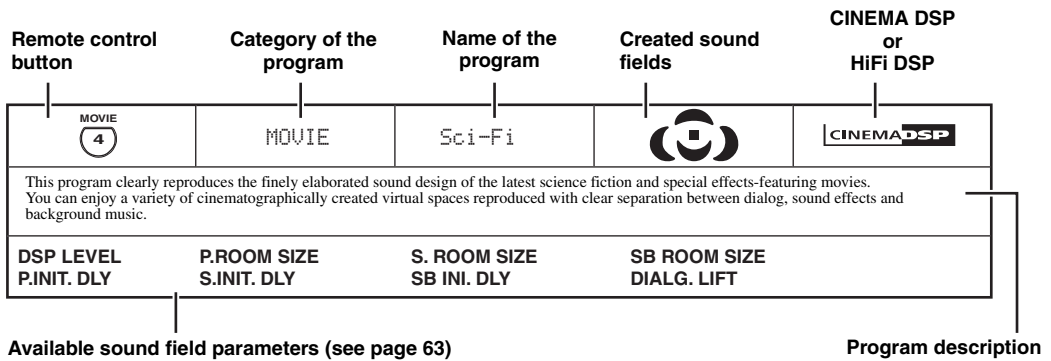

### Sound field indicators

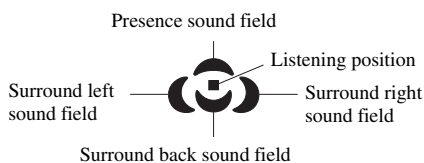

## ■ For audio music sources



For audio music sources, we also recommend using the Pure Direct mode (see page 48).

### Notes



- The available sound field parameters differ depending on the settings of the speakers.
- “DIALG.LIFT” is available only when “EXTRA SP ASSIGN” in “SPEAKER SET” is set to “PRESENCE” (see page 72).



CLASSICAL 1	CLASSICAL	Hall in Munich		HiFi DSP
This sound field simulates a concert hall with approximately 2500 seats in Munich, using stylish wood for the interior finishing as normal standards for European concert halls. Fine, beautiful reverberations spread richly, creating a calming atmosphere. The listener's virtual seat is at the center left of the arena.				
<b>DSP LEVEL INIT. DLY</b>	<b>ROOM SIZE LIVENESS</b>	<b>DIALG.LIFT</b>		
CLASSICAL 1	CLASSICAL	Hall in Vienna		HiFi DSP
This is an approximately 1700-seated, middle-sized concert hall with a shoebox shape that is traditional in Vienna. Pillars and ornate carvings create extremely complex reflections from all around the audience, producing a very full, rich sound.				
<b>DSP LEVEL INIT. DLY</b>	<b>ROOM SIZE LIVENESS</b>	<b>DIALG.LIFT</b>		
CLASSICAL 1	CLASSICAL	Chamber		HiFi DSP
This program creates a relatively wide space with a high ceiling like an audience hall in a palace. It offers pleasant reverberations that are suitable for courtly music and chamber music.				
<b>DSP LEVEL INIT. DLY</b>	<b>LIVENESS REV.TIME</b>	<b>REV.DELAY REV. LEVEL</b>	<b>DIALG.LIFT</b>	
LIVE/CLUB 2	LIVE/CLUB	Cellar Club		HiFi DSP
This program simulates a live house with a low ceiling and homey atmosphere. A realistic, live sound field features powerful sound as if the listener is in a row in front of a small stage.				
<b>DSP LEVEL INIT. DLY</b>	<b>ROOM SIZE LIVENESS</b>	<b>DIALG.LIFT</b>		
LIVE/CLUB 2	LIVE/CLUB	The Roxy Theatre		HiFi DSP
This is the sound field of a rock music live house in Los Angeles, with approximately 460 seats. The listener's virtual seat is at the center left of the hall.				
<b>DSP LEVEL INIT. DLY</b>	<b>ROOM SIZE LIVENESS</b>	<b>REV.TIME REV.DELAY</b>	<b>REV. LEVEL DIALG.LIFT</b>	
LIVE/CLUB 2	LIVE/CLUB	The Bottom Line		HiFi DSP
This is the sound field at stage front in The Bottom Line, a famous New York jazz club. The floor can seat 300 people to the left and right in a sound field offering real and vibrant sound.				
<b>DSP LEVEL INIT. DLY</b>	<b>ROOM SIZE LIVENESS</b>	<b>DIALG.LIFT</b>		



■ For various sources

Notes

- The available sound field parameters and the created sound fields differ depending on the input sources and the settings of this unit.
- “DIALG.LIFT” is available only when “EXTRA SP ASSIGN” in “SPEAKER SET” is set to “PRESENCE” (see page 72).

ENTERTAIN 3	ENTERTAINMENT	Sports		
This program allows the listeners to enjoy stereo sport broadcasts and studio variety programs with enriched live feeling. In sports broadcasts, the voices of the commentator and sportscaster are positioned clearly at the center while the atmosphere of the stadium expands in an optimum space to offer the listeners with a feeling of presence in the stadium.				
<b>DSP LEVEL</b> P. INIT. DLY	<b>P. ROOM SIZE</b> S. INIT. DLY	<b>S. ROOM SIZE</b> SB INI. DLY	<b>SB ROOM SIZE</b> DIALG.LIFT	



ENTERTAIN 3	ENTERTAINMENT	Action Game		
This sound field has been suitable for action games such as car racing and FPS games. It uses the reflection data that limits the effects range per channel in order to offer a powerful playing environment with a being-there feeling by enhancing various effects tones while maintaining a clear sense of directions.				
<b>DSP LEVEL</b> P. INIT. DLY	<b>P. ROOM SIZE</b> S. INIT. DLY	<b>S. ROOM SIZE</b> SB INI. DLY	<b>SB ROOM SIZE</b> DIALG.LIFT	

ENTERTAIN 3	ENTERTAINMENT	Roleplaying Game		
This sound field has been suitable for role-playing and adventure games. It combines the sound field effects for movies and the sound field designs for “Action Game” to represent the depth and 3D feeling of the field during play, while offering movie-like surround effects in the movie scenes in the game.				
<b>DSP LEVEL</b> P. INIT. DLY	<b>P. ROOM SIZE</b> S. INIT. DLY	<b>S. ROOM SIZE</b> SB INI. DLY	<b>SB ROOM SIZE</b> DIALG.LIFT	

■ For visual sources of music

Notes

- The available sound field parameters and the created sound fields differ depending on the input sources and the settings of this unit.
- “DIALG.LIFT” is available only when “EXTRA SP ASSIGN” in “SPEAKER SET” is set to “PRESENCE” (see page 72).

ENTERTAIN 3	ENTERTAINMENT	Music Video		
This sound field offers an image of a concert hall for live performance of pop, rock and jazz music. The listener can indulge oneself in a hot live space thanks to the presence sound field that emphasizes the vividness of vocals and solo play and the beat of rhythm instruments, and to the surround sound field that reproduces the space of a big live hall.				
<b>DSP LEVEL</b> P. INIT. DLY	<b>P. ROOM SIZE</b> S. INIT. DLY	<b>S. ROOM SIZE</b> SB INI. DLY	<b>SB ROOM SIZE</b> DIALG.LIFT	



## ■ For movie sources



You can select the desired decoder used with following sound field program (except “Mono Movie”). See page 66 for details.

### Notes

- The available sound field parameters and the created sound fields differ depending on the input sources and the settings of this unit.
- “DIALG.LIFT” is available only when “EXTRA SP ASSIGN” in “SPEAKER SET” is set to “PRESENCE” (see page 72).

	MOVIE	Standard		
This program creates a sound field emphasizing the surrounding feeling without disturbing the original acoustic positioning of multi-channel audio such as Dolby Digital and DTS. It has been designed with the concept of “an ideal movie theater”, in which the audience is surrounded by beautiful reverberations from the left, right and rear.				
<b>DSP LEVEL</b> <b>S. INIT. DLY</b>	<b>S. ROOM SIZE</b> <b>S.LIVENESS</b>	<b>SB INI. DLY</b> <b>SB ROOM SIZE</b>	<b>SB LIVENESS</b> <b>DIALG.LIFT</b>	

	MOVIE	Spectacle		
This program represents the spectacular feeling of large-scale movie productions. It reproduces a broad theater sound field matching the cinemascope and wider-screen movies with an excellent dynamic range from very small to extremely large sound.				
<b>DSP LEVEL</b> <b>P. INIT. DLY</b>	<b>P. ROOM SIZE</b> <b>S. INIT. DLY</b>	<b>S. ROOM SIZE</b> <b>SB INI. DLY</b>	<b>SB ROOM SIZE</b> <b>DIALG.LIFT</b>	

	MOVIE	Sci-Fi		
This program clearly reproduces the finely elaborated sound design of the latest science fiction and special effects-featuring movies. You can enjoy a variety of cinematographically created virtual spaces reproduced with clear separation between dialog, sound effects and background music.				
<b>DSP LEVEL</b> <b>P. INIT. DLY</b>	<b>P. ROOM SIZE</b> <b>S. INIT. DLY</b>	<b>S. ROOM SIZE</b> <b>SB INI. DLY</b>	<b>SB ROOM SIZE</b> <b>DIALG.LIFT</b>	

	MOVIE	Adventure		
This program is ideal for precisely reproducing the sound design of action and adventure movies. The sound field restrains reverberations but puts emphasis on reproducing a powerful space expanded widely to the left and right. The reproduced depth is also restrained relatively to ensure the separation between audio channels and the clarity of the sound.				
<b>DSP LEVEL</b> <b>P. INIT. DLY</b>	<b>P. ROOM SIZE</b> <b>S. INIT. DLY</b>	<b>S. ROOM SIZE</b> <b>SB INI. DLY</b>	<b>SB ROOM SIZE</b> <b>DIALG.LIFT</b>	

	MOVIE	Drama		
This sound field features stable reverberations that match a wide range of movie genres from serious dramas to musicals and comedies. The reverberations are modest but offer an optimum 3D feeling, reproducing effects tones and background music softly but cubically around clear words and center positioning in a way that does not fatigue the listener even after long hours of viewing.				
<b>DSP LEVEL</b> <b>P. INIT. DLY</b>	<b>P. ROOM SIZE</b> <b>S. INIT. DLY</b>	<b>S. ROOM SIZE</b> <b>SB INI. DLY</b>	<b>SB ROOM SIZE</b> <b>DIALG.LIFT</b>	

	MOVIE	Mono Movie		
This program is provided for reproducing monaural video sources such as a classic movie in an atmosphere of a good old movie theater. The program produces the optimum expansion and reverberation to the original audio to create a comfortable space with a certain sound depth.				
<b>DSP LEVEL</b> <b>INIT. DLY</b>	<b>ROOM SIZE</b> <b>LIVENESS</b>	<b>REV.TIME</b> <b>REV.DELAY</b>	<b>REV. LEVEL</b> <b>DIALG.LIFT</b>	

## ■ Stereo playback

### Note

The available parameters differ depending on the input sources and the settings of this unit.

STEREO 5	STEREO	2ch STEREO	/	/
Use this program to mix down multi-channel sources to 2 channels. See page 49 for details.				
<b>DIRECT</b>				
STEREO 5	STEREO	7ch STEREO	/	<b>HiFi DSP</b>
Use this program to output sound from all speakers. When you play back multi-channel sources, this unit downmixes the source to 2 channels, and then outputs the sound from all speakers. This program creates a larger sound field and is ideal for background music at parties, etc.				
<b>CT LEVEL</b> <b>SL LEVEL</b>	<b>SR LEVEL</b> <b>SB LEVEL</b>	<b>PL LEVEL</b> <b>PR LEVEL</b>		

## ■ The Compressed Music Enhancer

ENHANCER 6	MUSIC ENHANCER	2ch Enhancer	/	/
The Compressed Music Enhancer feature of this unit enhances your listening experience by regenerating the missing harmonics in a compression artifact. As a result, flattened complexity due to the loss of high-frequency fidelity as well as lack of bass due to the loss of low-frequency bass is compensated, providing improved performance of the overall sound system. Use this program to play back compression artifacts in 2-channel stereo.				
<b>Effect level</b>				
ENHANCER 6	MUSIC ENHANCER	7ch Enhancer	/	/
Use this program to play back compression artifacts in 7-channel stereo.				
<b>Effect level</b>				

## ■ Using sound field programs without surround speakers (Virtual CINEMA DSP)

Virtual CINEMA DSP allows you to enjoy the CINEMA DSP programs without surround speakers. It creates virtual speakers to reproduce the natural sound field. When you set “SUR. L/R SP” to “NONE” (see page 73), Virtual CINEMA DSP activates automatically whenever you select a CINEMA DSP or HiFi DSP sound field program (see page 42).

### Note

Virtual CINEMA DSP will not activate even when “SUR. L/R SP” is set to “NONE” (see page 73) in the following cases:

- when the component connected to the MULTI CH INPUT jacks is selected as the input source (see page 38).
- when headphones are connected to the PHONES jack.
- when this unit is in the “7ch Stereo” mode.

## ■ Enjoying multi-channel sources and sound field programs with headphones (SILENT CINEMA)

SILENT CINEMA allows you to enjoy multi-channel music or movie sound, including Dolby Digital and DTS sources, through ordinary headphones. SILENT CINEMA activates automatically whenever you connect headphones to the PHONES jack while listening to CINEMA DSP or HiFi DSP sound field programs (see page 42). When activated, the SILENT CINEMA indicator lights up in the front panel display.

### Notes

- SILENT CINEMA does not activate when the component connected to the MULTI CH INPUT jacks is selected as the input source (see page 38).
- SILENT CINEMA is not effective when the Pure Direct (see page 48) or “2ch Stereo” mode (see page 49) is selected, or when this unit is in the “STRAIGHT” mode (see page 47).

## ***Enjoying unprocessed input sources (Straight decoding mode)***

When this unit is in the “STRAIGHT” mode, 2-channel stereo sources are output from only the front left and right speakers. Multi-channel sources are decoded straight into the appropriate channels without any additional effect processing.

---

Press **Ⓜ** **STRAIGHT** (or **Ⓢ** **STRAIGHT**) to select “STRAIGHT”.

STRAIGHT

### ■ Deactivating the “STRAIGHT” mode

---

Press **Ⓜ** **STRAIGHT** (or **Ⓢ** **STRAIGHT**) so that “STRAIGHT” disappears from the front panel display.

The sound effect is turned back on.

# Using audio features



Before performing operations, set the operation mode selector on the remote control to **AMP**.

## Enjoying pure hi-fi sound

Use the Pure Direct mode to enjoy the pure high fidelity sound of the selected source. When the Pure Direct mode is activated, this unit plays back the selected source with the least circuitry.

Press **PURE DIRECT** (or **PURE DIRECT**) to turn the Pure Direct mode on or off.

The **PURE DIRECT** button lights up while this unit is in the Pure Direct mode. The front panel display automatically dims.

### Notes

- The following operations are not possible when this unit is in the Pure Direct mode:
  - switching the sound field program
  - displaying the OSD
  - adjusting the “SET MENU” parameters (except for level settings)
  - operating video functions (video conversion, etc.)
- The Pure Direct mode is automatically canceled whenever this unit is turned off.



The front panel display turns on momentarily when an operation is performed.

## Adjusting the tonal quality

Use this feature to adjust the balance of bass and treble for the front left and right speaker channels.



Speaker and headphone adjustments are stored independently.

**1 Press TONE CONTROL on the front panel repeatedly to select the high-frequency response (TREBLE) or the low-frequency response (BASS).**

**2 Rotate the PROGRAM selector to adjust the high-frequency response (TREBLE) or the low-frequency response (BASS).**

### Notes

- If you increase or decrease the high-frequency or the low-frequency sound to an extreme level, the tonal quality of the surround speakers may not match.
- TONE CONTROL is not effective when PURE DIRECT is selected, or when MULTI CH INPUT is selected as the input source.

## Adjusting the speaker level

You can adjust the output level of each speaker while listening to a music source. This is also possible when playing sources input at the MULTI CH INPUT jacks.

### Note

This operation will override the level adjustments made in “AUTO SETUP” (see page 28) and “SPEAKER LEVEL” (see page 74).

**1 Press LEVEL on the remote control repeatedly to select the speaker you want to adjust.**

Display	Adjusted speaker
FRONT L	Front left speaker
FRONT R	Front right speaker
CENTER	Center speaker
SWFR	Subwoofer
SUR. L	Surround left speaker
SUR. R	Surround right speaker
SUR. B. L	Surround back left speaker
SUR. B. R	Surround back right speaker
PRNS L	Presence left speaker
PRNS R	Presence right speaker



- Once you press **LEVEL** on the remote control, you can also select the speaker by pressing **Δ / ▽**.
- Instead of “SUR.B.L” and “SUR.B.R”, “SUR.B” is displayed if “SB L/R SP” is set to either “SMLx1” or “LRGx1” (see page 73).
- The available speaker channels differ depending on the setting of the speakers.

**2 Press ◀ / ▶ to adjust the speaker output level.**

- Press **▶** to increase the value.
- Press **◀** to decrease the value.

Control range: -10.0 dB to +10.0 dB

## Enjoying multi-channel sources in 2-channel stereo

You can mix down multi-channel sources to 2 channels and enjoy playback in 2-channel stereo.

Press **Ⓢ** **STEREO** on the remote control repeatedly to select “2ch Stereo”.



- You can use a subwoofer with this program when “LFE/BASS OUT” is set to “SWFR” or “BOTH” (see page 74).
- You can also select the “2ch Stereo” mode by rotating the **Ⓢ** **PROGRAM** selector on the front panel.
- See page 66 for details about the parameters of the “2ch Stereo” mode.

## Selecting the night listening mode

The night listening modes are designed to improve listenability at lower volumes or at night.

**1** Press **Ⓢ** **NIGHT** on the remote control repeatedly to select “NIGHT:CINEMA” or “NIGHT:MUSIC”.

Choices: NIGHT:CINEMA, NIGHT:MUSIC, OFF

- Select “NIGHT:CINEMA” when watching films to reduce the dynamic range of film soundtracks and make dialog easier to hear at lower volumes.
- Select “NIGHT:MUSIC” when listening to music sources to preserve ease-of-listening for all sounds.
- Select “OFF” if you do not want to use this feature.



When a night listening mode is selected, the NIGHT indicator lights up in the front panel display.

**2** Press **Ⓢ** **</>** to adjust the effect level while “NIGHT:CINEMA” or “NIGHT:MUSIC” is displayed in the front panel display.

Effect.Lvl: MID

Choices: MIN, **MID**, MAX

- Select “MIN” for minimum compression.
- Select “MID” for standard compression.
- Select “MAX” for maximum compression.



“NIGHT:CINEMA” and “NIGHT:MUSIC” adjustments are stored independently.

### Notes

- You cannot use the night listening modes in the following cases:
  - when the Pure Direct mode (see page 48) is selected.
  - when the component connected to the MULTI CH INPUT jacks is selected as the input source (see page 38).
  - when headphones are connected to the PHONES jack.
- The night listening modes may vary in effectiveness depending on the input source and surround sound settings you use.

# FM/AM tuning

There are 2 tuning methods: automatic and manual. Automatic tuning is effective when station signals are strong and there is no interference. If the signal from the station you want to select is weak, tune into it manually. You can also use the automatic and manual preset tuning features to store up to 40 stations (A1 to E8: 8 preset station numbers in each of the 5 preset station groups). Furthermore, you can recall any preset stations and exchange the assignment of two preset stations with each other.

## Note

Orient the connected FM and AM antennas for the best reception.

## Automatic tuning

Automatic tuning is effective when station signals are strong and there is no interference.

- 1 Rotate the ⑩ **INPUT** selector on the front panel to select “**TUNER**” as the input source.
- 2 Press ③ **FM/AM** to select the reception band. “FM” or “AM” appears in the front panel display.
- 3 Press ⑦ **TUNING AUTO/MAN'L** so that the **AUTO** indicator lights up in the front panel display.

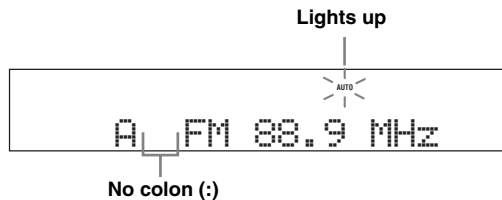

If a colon (:) appears in the front panel display, tuning is not possible. Press ② **PRESET/TUNING** to turn the colon (:) off.

- 4 Press ⑤ **PRESET/TUNING/CH** </> once to begin automatic tuning.

When this unit is tuned into a station, the **TUNED** indicator lights up and the frequency of the received station is shown in the front panel display.

- Press ⑤ > to tune into a higher frequency.
- Press ⑤ < to tune into a lower frequency.

## Manual tuning

If the signal received from the station you want to select is weak, tune into it manually.

## Note

Manually tuning into an FM station automatically switches the tuner to monaural reception to increase the signal quality.

- 1 Rotate the ⑩ **INPUT** selector on the front panel to select “**TUNER**” as the input source.
- 2 Press ③ **FM/AM** to select the reception band. “FM” or “AM” appears in the front panel display.
- 3 Press ⑦ **TUNING AUTO/MAN'L** so that the **AUTO** indicator disappears from the front panel display.

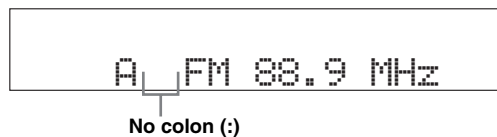

If a colon (:) appears in the front panel display, tuning is not possible. Press ② **PRESET/TUNING** to turn the colon (:) off.

- 4 Press ⑤ **PRESET/TUNING/CH** </> to tune into the desired station manually.



Hold down the button to continue searching.

## Automatic preset tuning

You can use the automatic preset tuning feature to store up to 40 FM stations with strong signals (A1 to E8: 8 preset station numbers in each of the 5 preset station groups) in order. You can then recall any preset station easily by selecting the preset station number.

**1 Rotate the ⑱ INPUT selector on the front panel to select “TUNER” as the input source.**

**2 Press ⑳ FM/AM to select “FM” as the reception band.**

“FM” appears in the front panel display.

**3 Press and hold ㉑ MEMORY for more than 3 seconds.**

The preset station number as well as the MEMORY and AUTO indicators flashes. After approximately 5 seconds, automatic presetting starts from the current frequency and proceeds toward higher frequencies.

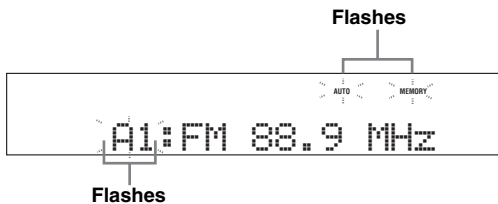

When automatic preset tuning is completed, the front panel display shows the frequency of the last preset station.



- You can specify the preset number from which this unit stores FM stations. Press ⑳ A/B/C/D/E and then ㉑ PRESET/TUNING/CH </> repeatedly after you perform step 3 to select the preset station number under which the first station will be stored.
- You can begin tuning toward lower frequencies to store FM stations automatically. Press ㉒ PRESET/TUNING so that the colon (:) disappears from the front panel display and then press ㉑ PRESET/TUNING/CH </> after pressing and holding ㉑ MEMORY for more than 3 seconds.

### Notes

- Any stored station data existing under a preset station number is cleared when you store a new station under the same preset station number.
- If the number of received stations does not reach 40 (E8), automatic preset tuning automatically stops after searching for all the available stations.
- Only FM stations with sufficient signal strength are stored automatically by automatic preset tuning. If the station you want to store is weak in signal strength, tune into it manually and store it as described in “Manual preset tuning” below.

## Manual preset tuning

You can also store up to 40 stations (A1 to E8: 8 preset station numbers in each of the 5 preset station groups) manually.

**1 Tune into a station.**

See page 50 for tuning instructions.

**2 Press ㉑ MEMORY on the front panel.**

The MEMORY indicator flashes in the front panel display for approximately 10 seconds.

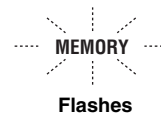

**3 Press ⑳ A/B/C/D/E repeatedly to select a preset station group (A to E) while the MEMORY indicator is flashing.**

The selected preset station group letter appears. Check that the colon (:) appears in the front panel display.

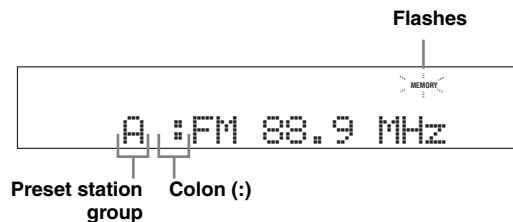

- 4 Press ⑤ PRESET/TUNING/CH </> to select a preset station number (1 to 8) while the MEMORY indicator is flashing.**
- Press ⑤ > to select a higher preset station number.
  - Press ⑤ < to select a lower preset station number.

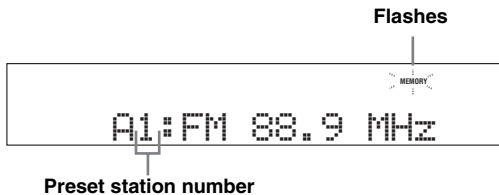

- 5 Press ⑥ MEMORY while the MEMORY indicator is flashing.**
- The station band and frequency appear in the front panel display with the preset station group and number you have selected. The MEMORY indicator disappears from the front panel display.

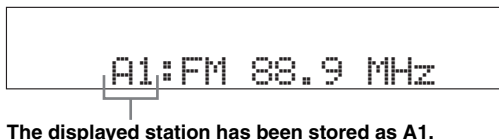

**Notes**

- Any stored station data existing under a preset station number is cleared when you store a new station under the same preset station number.
- The reception mode (stereo or monaural) is stored along with the station frequency.

**Selecting preset stations**

You can tune into any desired station simply by selecting the preset station group and number under which it was stored.



When performing this operation with the remote control, set the operation mode selector to ①SOURCE and then press TUNER to select "TUNER" as the input source.

- 1 Press ④ A/B/C/D/E (or press ② A-E/CAT. </>) to select the desired preset station group (A to E).**
- The preset station group letter appears in the front panel display and changes each time you press the button.

- 2 Press ⑤ PRESET/TUNING/CH </> on the front panel (or ② PRESET/CH Δ / ▽ on the remote control) to select the desired preset station number (1 to 8).**
- The preset station group and number appear in the front panel display along with the station band and frequency.



**Exchanging preset stations**

You can exchange the assignments of two preset stations with each other. The example below describes the procedure to exchange preset station "E1" with "A5".

- 1 Select preset station "E1" using ④ A/B/C/D/E and ⑤ PRESET/TUNING/CH </> on the front panel.**
- See "Selecting preset stations" on the left column.
- 2 Press and hold ② EDIT for more than 3 seconds.**
- "E1" and the MEMORY indicator flash in the front panel display.

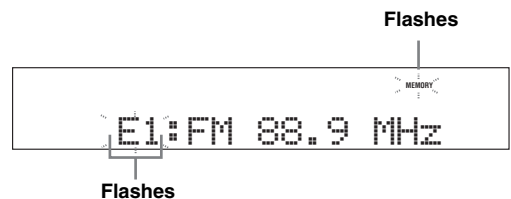

- 3 Select preset station "A5" using ④ A/B/C/D/E and ⑤ PRESET/TUNING/CH </>.**
- "A5" and the MEMORY indicator flash in the front panel display.
- See "Selecting preset stations" on the left column.

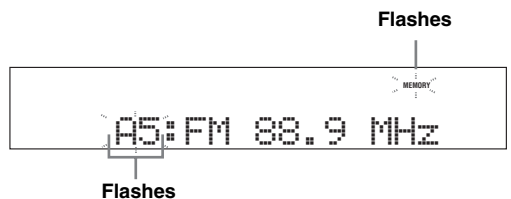

- 4 Press ② EDIT again.**
- "EDIT E1-A5" appears in the front panel display and the assignments of the two preset stations are exchanged.



# XM Satellite Radio tuning

XM Satellite Radio offers an extraordinary variety of commercial-free music, plus the best in sports, news, talk and entertainment. XM is broadcast in superior digital audio from coast to coast. From rock to reggae, from classical to hip hop, XM has something for every music fan. XM's dedication to playing the richest selection of music is matched by its passion for live sporting events, talk radio, up-to-the-minute news, stand-up comedy, children's programming, and much more.

For U.S. customers, information about XM Satellite Radio is available online at [www.xmradio.com](http://www.xmradio.com).

For Canadian customers, information about XM Canada is online at [www.xmradio.ca](http://www.xmradio.ca).

This unit is equipped with the Neural Surround decoder that plays back the XM HD surround sound content of the XM Satellite Radio broadcasts in multi-channels, resulting in a full surround sound experience.

## Note

The XM Satellite Radio service is only available in the 48 contiguous United States (not available in Alaska and Hawaii) and Canada.

## Information from XM Satellite Radio Inc.

Hardware and required monthly subscription sold separately. Other fees and taxes, including a one-time activation fee may apply. Subscription fee is consumer only. All fees and programming subject to change. Subscriptions subject to Customer Agreement available at [xmradio.com](http://xmradio.com) (US residents) and [xmradio.ca](http://xmradio.ca) (Canadian residents). Only available in the 48 contiguous United States and Canada. ©2006 XM Satellite Radio Inc. All rights reserved. All other trademarks are the property of their respective owners.

## Connecting the XM Mini-Tuner Dock

Connect the XM Mini-Tuner and the XM Dock (sold separately) to the XM jack on the rear panel of this unit. For details, see the operating instructions provided with the XM Mini-Tuner Dock.

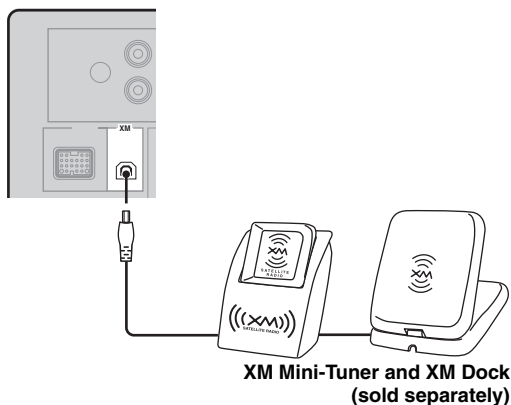

- To ensure optimal reception of the XM Satellite Radio signals, the XM Mini-Tuner Dock must be placed at or near a southerly facing window with no obstacles in the path to the sky. You can mount it indoors or outdoors.
- Use the "XM ANTENNA" parameter in "OPTION MENU" (see page 83) to display the XM Satellite Radio reception level in the OSD. For the best reception, orient the connected the XM Mini-Tuner so that a value of 60% or more is displayed.

## Note

If "CHECK ANTENNA" appears in the front panel display, the XM Mini-Tuner Dock may not be connected to the XM jack on the rear panel of this unit properly.

## Activating XM Satellite Radio

Once you have installed the XM Mini-Tuner Dock, inserted the XM Mini-Tuner, connected the XM Dock to your XM Ready® home audio system, and installed the antenna, you are ready to subscribe and begin receiving XM programming. There are three places to find your eight character XM Radio ID: on the XM Mini-Tuner, on the XM Mini-Tuner package, and on XM Channel 0. Record the Radio ID in the following eight squares for reference.



### Note

The XM Radio ID does not use the letters “I”, “O”, “S” or “F”. Activate your XM Satellite Radio service in the U.S. online at <http://www.xmradio.com/> or call 1-800-XM-RADIO (1-800-967-2346). You will need a major credit card. XM will send a signal from the satellites to activate the full channel lineup. Activation normally takes 10 to 15 minutes, but during peak busy periods you may need to keep your XM Ready home audio system on for up to an hour. When you can access the full channel lineup on your XM Ready home audio system you are done. For more information or to subscribe in Canada, visit XM on the Web at [www.xmradio.ca](http://www.xmradio.ca) or call XM’s Listener Care at 1-877-GET-XMSR (1-877-438-9677).

## Basic XM Satellite Radio operations



Before performing operations, set the operation mode selector on the remote control to **ⓀSOURCE**.

### 1 Rotate the **ⓀINPUT** selector (or press **ⒶXM**) to select “XM” as the input source.

The cursor on the left of the XM indicator lights up in the front panel display and the XM Satellite Radio information (such as channel number, channel name, category, artist name, or song title) for the currently selected channel appears in the front panel display.

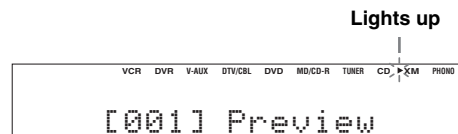

When you select “XM” as the input source, this unit automatically recalls the previously selected channel.

### Note

The XM Satellite Radio signals cannot be output at the AUDIO OUT (REC) jacks.

### 2 Search for a channel by using one of the XM Satellite Radio search modes.

- To select a channel from the all channel list, see “All Channel Search mode” on page 55.
- To select a channel by category, see “Category Search mode” on page 55.
- To select a channel from the preset channels, see “Preset Search mode” on page 55.
- To select the desired channel directly by entering the channel number, see “Direct number access mode” on page 55.



- You can use the Neural Surround decoder to enjoy the XM HD surround sound content of the XM Satellite Radio broadcasts in multi-channels (see page 67).
- You can set the XM Satellite Radio preset channels (see page 56).
- You can display the XM Satellite Radio information in the front panel display or in the OSD (see page 57).

Before performing operations, set the operation mode selector on the remote control to **ⓀSOURCE**.

### ■ All Channel Search mode

**1** Press **②SEARCH MODE** (or **ⓃSRCH MODE**) repeatedly to select “ALL CH SEARCH”.

**2** Press **⑤PRESET/TUNING/CH**  $\triangleleft/\triangleright$  (or **⑩PRESET/CH**  $\triangle/\nabla$ ) repeatedly to search for a channel within all channels.



- You can search for a channel quickly by pressing and holding **⑤PRESET/TUNING/CH**  $\triangleleft/\triangleright$  (or **⑩PRESET/CH**  $\triangle/\nabla$ ).
- To display the XM Radio ID number displayed in the front panel display, select channel “0”.

### ■ Category Search mode

**1** Press **②SEARCH MODE** (or **ⓃSRCH MODE**) repeatedly to select “CAT SEARCH”.

**2** Press **④CATEGORY** (or **⑩A-E/CAT.**  $\triangleleft/\triangleright$ ) repeatedly to change the channel category.

**3** Press **⑤PRESET/TUNING/CH**  $\triangleleft/\triangleright$  (or **⑩PRESET/CH**  $\triangle/\nabla$ ) repeatedly to search for a channel within the selected channel category.



You can search for a channel quickly by pressing and holding **⑤PRESET/TUNING/CH**  $\triangleleft/\triangleright$  on the front panel (or **⑩PRESET/CH**  $\triangle/\nabla$  on the remote control).

### ■ Preset Search mode

Prior to selecting a preset channel in the Preset Search mode, you must preset XM Satellite Radio channels. For details, see “Setting the XM Satellite Radio preset channels” on page 56.



The initial factory setting of all preset channels (A1 to E8) is “[001] Preview”.

**1** Press **②SEARCH MODE** (or **ⓃSRCH MODE**) repeatedly to select “PRESET SEARCH”.

**2** Press **④CATEGORY** (or **⑩A-E/CAT.**  $\triangleleft/\triangleright$ ) repeatedly to change the preset channel group (A to E).

**3** Press **⑤PRESET/TUNING/CH**  $\triangleleft/\triangleright$  (or **⑩PRESET/CH**  $\triangle/\nabla$ ) repeatedly to change the preset channel number (1 to 8).



You can also select the preset channel number directly by pressing the numeric buttons (1 to 8) (**Ⓟ**).

### ■ Direct number access mode

**1** Press **ⓃSRCH MODE** on the remote control repeatedly to select “ALL CH SEARCH” or “CAT SEARCH”.

**2** Press the numeric buttons (**Ⓟ**) to enter the desired three-digit channel number.

For example, to enter the number 123, press the numeric buttons (**Ⓟ**) as shown below.



The display changes as follows.

<XM> ---1



<XM> -12



<XM>123



- To enter a one-digit or two-digit channel number, press the numeric buttons (**Ⓟ**) on the remote control and then press **ⓂENT** to confirm the input number.
- Instead of pressing **ⓂENT** to tune into the channel immediately, you can wait a few seconds until this unit confirms the entered channel number.
- If no button is pressed within a few seconds after you enter a one-digit or two-digit number, this unit automatically confirms the entered channel number.
- Pressing a button other than the numeric buttons (**Ⓟ**) or **ⓂENT** cancels the Direct Number Access mode procedure.

## Setting the XM Satellite Radio preset channels

You can use this feature to store up to 40 XM Satellite Radio channels (A1 to E8: 8 preset channel numbers in each of the 5 preset channel groups). You can then recall any preset channel easily by selecting the preset channel group and number as described in “Preset Search mode” on page 55.

### 1 Search for a channel you want to set as a preset channel by using one of the XM Satellite Radio search modes.

See “Basic XM Satellite Radio operations” on page 54 for details.

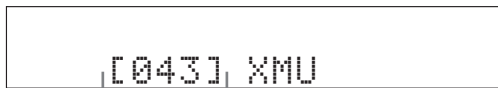

Currently selected channel number

### 2 Press **Ⓜ** MEMORY (or **Ⓜ** XM MEMORY).

The MEMORY indicator flashes in the front panel display for approximately 10 seconds.



Flashes

#### Note

You must proceed to and carry out steps 3 through 5 while the MEMORY indicator is flashing in the front panel display.

### 3 Press **ⓐ** CATEGORY (or **ⓐ** A-E/CAT. </>) repeatedly to select a preset channel group (A to E) while the MEMORY indicator is flashing.

The preset channel group letter appears in the front panel display.

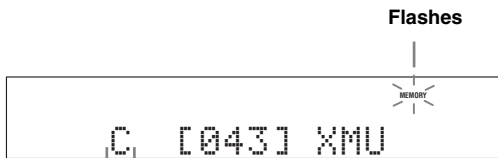

Currently selected preset channel group

### 4 Press **ⓑ** PRESET/TUNING/CH </> (or **ⓑ** PRESET/CH Δ/∇) repeatedly to select a preset channel number (1 to 8) while the MEMORY indicator is flashing.

The preset channel number appears in the front panel display.

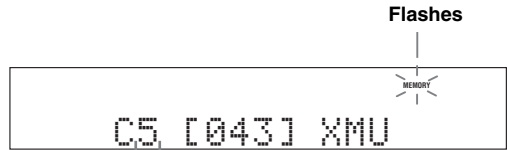

Currently selected preset channel number

### 5 Press **Ⓞ** MEMORY (or **Ⓞ** XM MEMORY) to set the selected XM Satellite Radio channel as a preset channel while the MEMORY indicator is flashing.

A colon (:) appears next to the preset channel number for confirmation, and the MEMORY indicator turns off in the front panel display.



Colon (:)

#### Note

Once you set a new preset channel, the one previously stored in the same preset channel group and number is cleared.

## Displaying the XM Satellite Radio information

You can display the XM Satellite Radio information (such as channel number, channel name, category, artist name, or song title) for the currently selected channel in the front panel display or in the OSD.

### Note

If a status message or an error message appears in the front panel display or in the OSD, see the “XM Satellite Radio” section in “Troubleshooting” on page 96 for appropriate remedies.

### ■ Displaying the XM Satellite Radio information in the front panel display

Press **ⓇDISPLAY** (or **ⓈDISPLAY**) repeatedly to toggle between the following XM Satellite Radio information display modes.

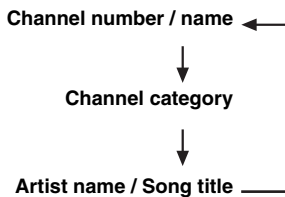

When the channel number / name is displayed:

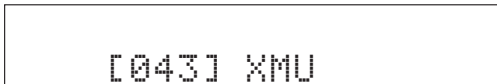

When the channel category is displayed:



When the artist name / song title is displayed:

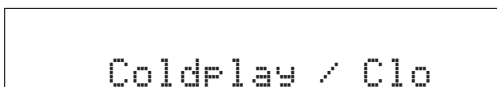

- The front panel display can indicate up to 14 alphanumeric characters at once. You can set whether to display the XM Satellite Radio information in the front panel display in a continuous manner or by 14 alphanumeric characters at once by using the “FL SCROLL” parameter in “OPTION MENU” (see page 81).
- If the XM Satellite Radio information contains a character that cannot be recognized by this unit, the character will be displayed with a space.

### Note

If you press **ⓇDISPLAY** (or **ⓈDISPLAY**) while the XM Satellite Radio information display is scrolling from right to left in the front panel display, the XM Satellite Radio information display mode toggles as described above.

### ■ Displaying the XM Satellite Radio information in the OSD

Press **ⓇDISPLAY** (or **ⓈDISPLAY**).

The following screen is displayed in the OSD.

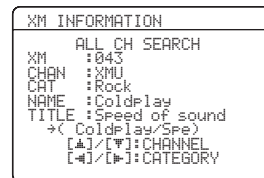

- To turn off the OSD, press **ⓇDISPLAY** (or **ⓈDISPLAY**) again.
- You can select the amount of time the XM Satellite Radio information is displayed in the OSD by using the “OSD-SOURCE” parameter in “OPTION MENU” (see page 81).
- To hold the XM Satellite Radio information screen, press **ⓈENTER** on the remote control while it is being displayed in the OSD.
- The XM Satellite Radio information screen on hold is released if you press **ⓈENTER** on the remote control again or if you change the XM Satellite Radio channel.
- This unit can save up to two XM Satellite Radio information screens for future reference. To view the previous two XM Satellite Radio information screens, press **ⓈTITLE** on the remote control repeatedly while the current XM Satellite Radio information screen is hold.

# Using iPod™

Once you have stationed your iPod in a Yamaha iPod universal dock (such as the YDS-10, sold separately) connected to the DOCK terminal of this unit (see page 23), you can enjoy playback of your iPod using the supplied remote control. You can also use the Compressed Music Enhancer mode of this unit to improve the sound quality of the compression artifacts (such as the MP3 format) stored on your iPod (see page 46).

## Notes

- Only iPod (Click and Wheel), iPod nano, and iPod mini are supported.
- Some features may not be compatible depending on the model or the software version of your iPod.



- For a complete list of the remote control functions used to control your iPod, see the “iPod” column in “Controlling other components” on page 86.
- For a complete list of status messages that appear in the front panel display and in the OSD, see the “iPod” section in “Troubleshooting” on page 101.
- Once the connection between your iPod and this unit is complete, “iPod connected” appears in the front panel display and the DOCK indicator lights up in the front panel display.
- Only the analog audio and video signals of your iPod are input at the DOCK terminal, and the analog audio signals can be output at the analog AUDIO OUT (REC) jacks for recording.
- Your iPod battery is automatically charged when your iPod is stationed in a Yamaha iPod universal dock connected to the DOCK terminal of this unit as long as this unit is turned on. You can also select whether this unit charges the battery of the stationed iPod or not when this unit is in the standby mode by selecting the “STANDBY CHARGE” parameter in “OPTION MENU” (see page 83). The DOCK indicator turns on while this unit charges the battery of the connected iPod when this unit is in the standby mode.

## Controlling iPod™

You can control your iPod when “V-AUX” is selected as the input source. The operations of your iPod can be done with the aid of the OSD of this unit (menu browse mode) or without it (simple remote mode).

### ■ Controlling iPod in the simple remote mode

You can perform the basic operations of your iPod (play, stop, skip, etc.) using the supplied remote control without the aid of the OSD of this unit.



- You can view the photos or video clips stored on your iPod.
- Operations can be also done with the controls on your iPod.

### ■ Controlling iPod in the menu browse mode

You can perform the advanced operations of your iPod using the supplied remote control with the aid of the OSD of this unit. You can browse the songs stored on your iPod in the OSD. Further, you can change or adjust settings for your iPod to suit your personal preferences.



- The name of the song being played also appears in the front panel display according to the “FL SCROLL” parameter in “OPTION MENU” (see page 81).
- You can select the amount of time the iPod menu and play information is displayed in the OSD by using the “OSD-SOURCE” in “OPTION MENU” (see page 81).

## Notes

- Operations cannot be done with the controls on your iPod.
- The YAMAHA logo appears in the display window of your iPod.
- There are some characters that cannot be displayed in the front panel display or in the OSD of this unit. Those characters are replaced with underscores “\_”.
- The “Settings” parameters can be changed or adjusted only in the OSD. Press ENTER on the remote control to toggle between the “Settings” parameter settings.
- You cannot browse the photos or video clips stored on your iPod in the OSD. Use the simple remote mode to enjoy watching the photos or video clips stored on your iPod.

- 1 Set the operation mode selector to **ⓀSOURCE** and then press **ⓄDISPLAY** on the remote control.**

The following display appears in the OSD.

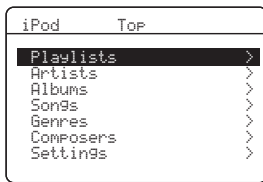

- 2 Press **ⓄΔ** / **▽** / **◀** / **▶** to navigate the iPod menu and then press **ⓄENTER** to begin playback of the selected song.**

Choices: Playlists (playlists), Artists (artists), Albums (albums), Songs (songs), Genres (genres), Composers (composers), Settings (settings)

- Playlists > Songs
- Artists > Albums > Songs
- Albums > Songs
- Songs
- Genres > Artists > Albums > Songs
- Composers > Albums > Songs
- Settings > Shuffle, Repeat

### Shuffle

Use this feature to set this unit to play songs or albums in random order.

Choices: Off, Songs, Albums

- Select "Off" to deactivate this feature.
- Select "Songs" to set this unit to play songs in random order.
- Select "Albums" to set this unit to play albums in random order.



When "Shuffle" is set to a setting other than "Off",  appears in the top right corner while songs or albums are being shuffled.



### Repeat

Use this feature to set this unit to repeat one song or a sequence of songs.

Choices: Off, One, All





- Select "Off" to deactivate this feature.
- Select "One" to set this unit to repeat one song.
- Select "All" to set this unit to repeat a sequence of songs.

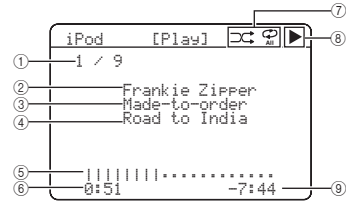

When "Repeat" is set to a setting other than "Off",  or  appears in the top right corner while one song or a sequence of songs are being repeated.

- **The function of the play information display**



- ① Track number/total tracks
- ② Name of the artist
- ③ Name of the album
- ④ Name of the song
- ⑤ Progress bar
- ⑥ Elapsed time
- ⑦ Shuffle and repeat icons
- ⑧ , ,  (search forward) and  (search backward)
- ⑨ Remaining time

# Recording

Recording adjustments and other operations are performed from the recording components. Refer to the operating instructions for those components.

## Caution

The DTS signal is a digital bitstream. Attempting to digitally record the DTS bitstream will result in noise being recorded. Therefore, if you want to use this unit to record sources encoded in DTS, the following considerations and adjustments need to be made. To play DTS-encoded DVDs and CDs (when using a digital audio connection) on your DTS-compatible player, follow its operating instructions to make a setting so that the analog signal will be output from the player.

## Notes

- When this unit is set to the standby mode, you cannot record between other components connected to this unit.
- TONE CONTROL (see page 48) and VOLUME settings, the speaker level (see page 74) and the sound field programs (see page 42) do not affect recorded material.
- The source connected to the MULTI CH INPUT jacks of this unit cannot be recorded.
- The XM Satellite Radio signals cannot be output at the AUDIO OUT (REC) jacks.
- Digital signals input at the DIGITAL INPUT jacks are not output at the analog AUDIO OUT (REC) jacks for recording. Likewise, analog signals input at the AUDIO IN jacks are not output at the DIGITAL OUTPUT jack. Therefore, if your source component is connected to provide only digital or analog signals, you can only record digital or analog signals.
- A given input source is not output on the same OUT (REC) channel.
- S-video and composite video signals pass independently through the video circuits of this unit. Therefore, when recording or dubbing video signals input from a video source component that provides only an S-video or a composite video signal, you can only record an S-video or a composite video signal on your VCR.
- The analog audio signals input at the DOCK terminal can be output at the analog AUDIO OUT (REC) jacks for recording.
- Check the copyright laws in your country to record from CDs, radio, etc. Recording of copyrighted material may infringe copyright laws.



Do a test recording before you start an actual recording.

If you play back a video source that uses scrambled or encoded signals to prevent it from being dubbed, the picture itself may be disturbed due to those signals.

---

**1 Turn on all the connected components.**

---

**2 Rotate the  INPUT selector (or press one of the input selector buttons ()) to select the source component you want to record from.**

---

**3 Start playback on the selected source component or select a broadcast station.**

---

**4 Start recording on the recording component.**



# Advanced sound configurations

## Changing sound field parameter settings

You can enjoy good quality sound with the initial factory settings. Although you do not have to change the initial factory settings, you can change some of the parameters to better suit the input source or your listening room.

### Note

You cannot change the sound field parameter values when “MEMORY GUARD” in “OPTION MENU” is set to “ON” (see page 82). If you want to change the sound field parameter values, set “MEMORY GUARD” to “OFF”.

**1 Turn on the video monitor connected to this unit.**

**2 Set the operation mode selector to **AMP** and then press **DISPLAY** on the remote control.**

The following status screen appears in the OSD.

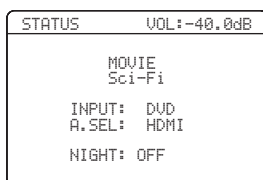

**3 Press one of the sound field program selector buttons (P) repeatedly to select the desired sound field program you want to adjust.**

**4 Press **DEL** / **UP** / **DOWN** to select the desired sound field parameter and then **DEL** / **LEFT** / **RIGHT** to change the selected sound field parameter value.**

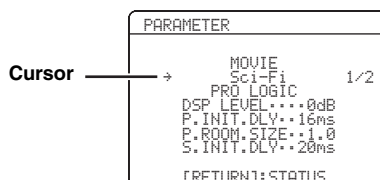

- For details about the function and control range of each sound field parameter, see page 63.
- When you set a sound field parameter to a value other than the initial factory settings, an asterisk mark (\*) appears by the sound field parameter name in the OSD.
- The available sound field parameters for some of the sound field programs may be displayed on more than one page in the OSD. In this case, press **DEL** / **UP** / **DOWN** to scroll through pages.
- If you press and hold **DEL** / **LEFT** / **RIGHT** to change the sound field parameter value, the initial factory settings are shown momentarily in the front panel display.
- Use the “PARAM. INI” feature in “OPTION MENU” to initialize the parameters of each sound field program within a sound field program group (see page 82).
- You can select the amount of time that the current status is displayed in the OSD by using the “OSD-AMP” parameter in “OPTION MENU” (see page 81).

**5 Press **DISPLAY** to turn off the sound field parameter display.**

## ■ Basic configuration of sound field programs



To change sound field parameter settings, see page 61 for details.

Each sound field program has some parameters defining the characteristics of the program. To customize the selected sound field program, adjust “DSP LEVEL” and/or “DIALG.LIFT” first, and then try other parameters.

### Adjusting the effect sound level of the sound field programs (DSP LEVEL)

Sound field programs add effect sounds (DSP effect sounds) to the original source sound to create sound field in the listening room. Use the “DSP LEVEL” parameter to adjust the level of the effect sounds.

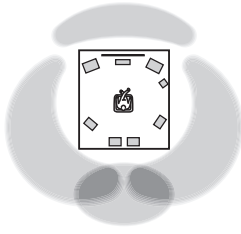

The DSP effect sound level is low.

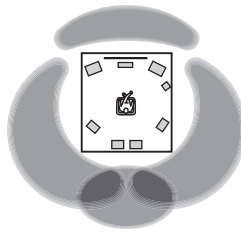

The DSP effect sound level is high.

Adjust “DSP LEVEL” as follows:

#### Increase the value of “DSP LEVEL” when

- The effect sound of the selected sound field program is too weak.
- You cannot recognize any difference between the sound field programs.

#### Decrease the value of “DSP LEVEL” when

- The sound is vague.
- You feel that the additional sound effect is excessive.

Control range: -6 dB to +3 dB

### Adjusting the vertical dialogue position (DIALG.LIFT)

Use this feature to adjust the vertical position of the dialogues in movies. The ideal position of the dialogues is at the center of the video monitor screen.

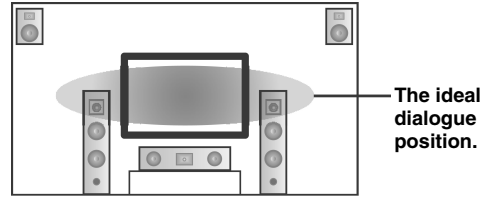

If the dialogues are heard at the lower position of the video monitor screen, increase the value of “DIALG.LIFT”.

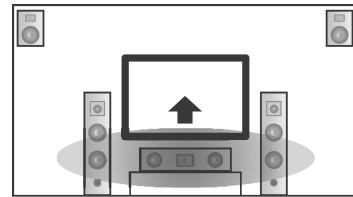

Move up to the ideal dialogue position.

Choices: 0, 1, 2, 3, 4, 5

“0” (initial setting) is the lowest position, and “5” is the highest position.

#### Notes

- “DIALG.LIFT” is only available only “EXTRA SP ASSIGN” is set to “PRESENCE” (see page 72).
- You cannot move the dialogue position down from the initial dialogue position.

## ■ Sound field parameters for the advanced configurations

Use the following sound field parameters to customize sound field programs in detail.



To change sound field parameter settings, see page 61 for details.

Sound field parameter	Features
INIT.DLY P.INIT.DLY S.INIT.DLY SB INI.DLY	<p>Initial delay. Presence, surround, and surround back sound field initial delay. Changes the apparent distance from the source sound by adjusting the delay between the direct sound and the first reflection heard by the listener. The smaller the value, the closer the sound source seems to the listener.</p> <p> When you adjust the initial delay parameters, we also recommend adjusting the corresponding room size parameters likewise. This adjustment is especially effective for the CINEMA DSP programs.</p> <hr/> <p>Control range: 1 to 99 ms (INIT.DLY and P.INIT.DLY) 1 to 49 ms (S.INIT.DLY and SB INI.DLY)</p>

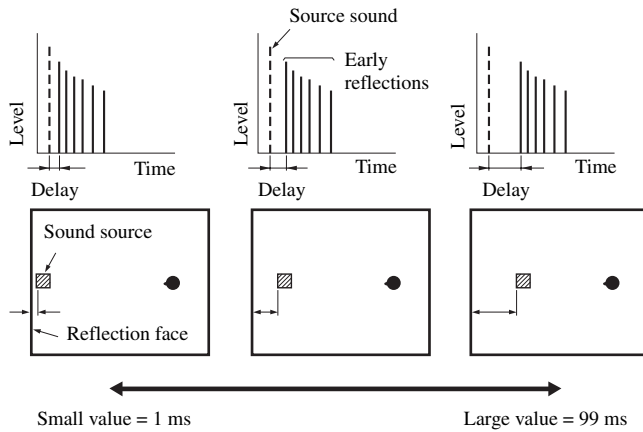

Sound field parameter	Features
-----------------------	----------

ROOM SIZE  
 P. ROOM SIZE  
 S. ROOM SIZE  
 SB ROOM SIZE

Room size. Presence, surround, and surround back room size. Adjusts the apparent size of the surround sound field. The larger the value, the larger the surround sound field becomes. As the sound is repeatedly reflected around a room, the larger the hall is, the longer the time between the original reflected sound and the subsequent reflections. By controlling the time between the reflected sounds, you can change the apparent size of the virtual venue. Changing this parameter from one to two doubles the apparent length of the room.



When you adjust the room size parameters, we also recommend adjusting the corresponding initial delay parameters likewise. This adjustment is especially effective for the CINEMA DSP programs.

Control range: 0.1 to 2.0

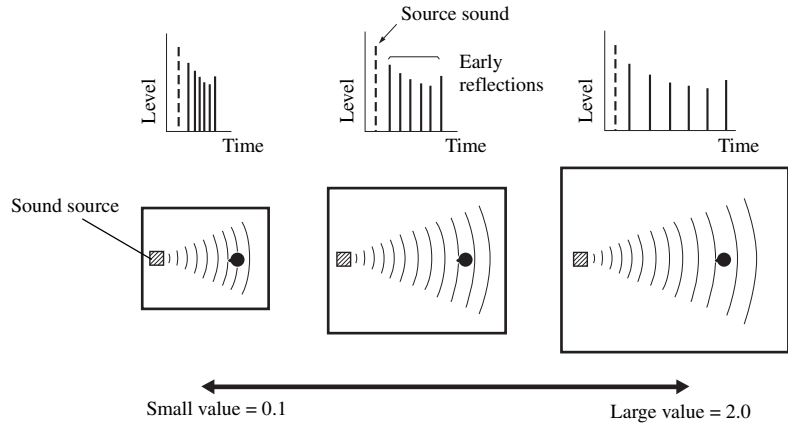

LIVENESS  
 S. LIVENESS  
 SB LIVENESS

Liveness. Surround and surround back sound field liveness. Adjusts the reflectivity of the virtual walls in the hall by changing the rate at which the early reflections decay. The early reflections of a sound source decay much faster in a room with acoustically absorbent wall surfaces than in one which has highly reflective surfaces. A room with acoustically absorbent surfaces is referred to as “dead”, while a room with highly reflective surfaces is referred to as “live”. This parameter lets you adjust the early reflection decay rate and thus the “liveness” of the room.

Control range: 0 to 10

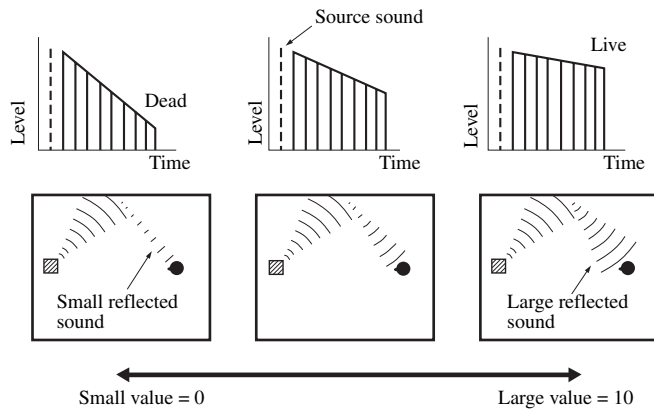

Sound field parameter	Features
-----------------------	----------

REV.TIME

Reverberation time. Adjusts the amount of time taken for the dense, subsequent reverberation sound to decay by 60 dB at 1 kHz. This changes the apparent size of the acoustic environment over an extremely wide range. Set a longer reverberation time for “dead” sources and listening room environments, and a shorter time for “live” sources and listening room environments.

Control range: 1.0 to 5.0 s

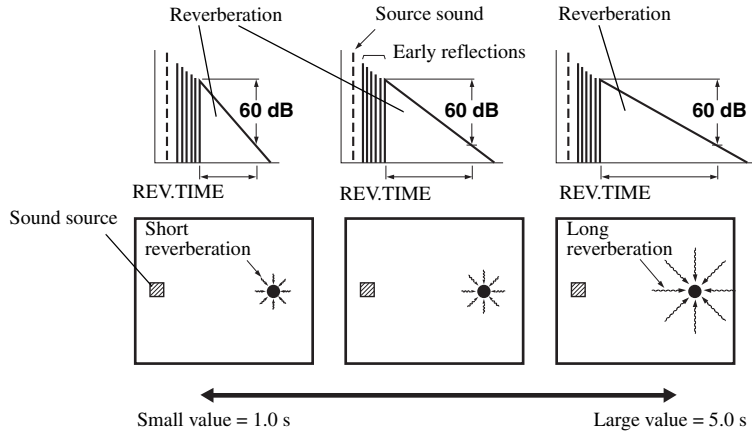

REV.DELAY

Reverberation delay. Adjusts the time difference between the beginning of the direct sound and the beginning of the reverberation sound. The larger the value, the later the reverberation sound begins. A later reverberation sound makes you feel as if you are in a larger acoustic environment.

Control range: 0 to 250 ms

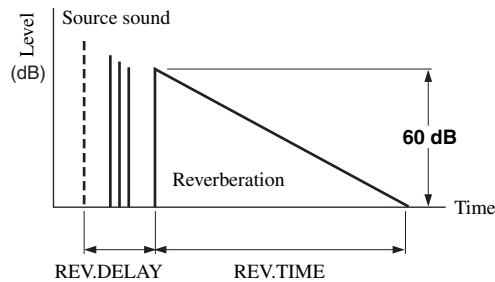

REV.LEVEL

Reverberation level. Adjusts the volume of the reverberation sound. The larger the value, the stronger the reverberation becomes.

Control range: 0 to 100%

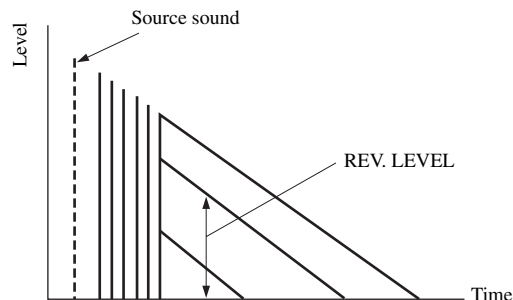

Sound field parameter	Features
2ch Stereo DIRECT	<p>2-channel stereo direct. Bypasses the decoders and the DSP processors of this unit for pure hi-fi stereo sound when playing 2-channel analog sources.</p> <hr/> <p>Choices: <b>AUTO</b>, OFF</p> <hr/> <p></p> <ul style="list-style-type: none"> <li>• Select “AUTO” to bypass the decoders, the DSP processors and the tone control circuitry only when “BASS” and “TREBLE” are set to 0 dB (see page 48).</li> <li>• Select “OFF” not to bypass the decoders, the DSP processors and the tone control circuitry when “BASS” and “TREBLE” are set to 0 dB.</li> <li>• When multi-channel signals (Dolby Digital and DTS) are input, they are downmixed to 2 channels and output from the front left and right speakers.</li> <li>• The low-frequency signals input from the front left and right speakers are redirected to the subwoofer in the following cases: <ul style="list-style-type: none"> <li>– “LFE/BASS OUT” is set to “BOTH” (see page 72).</li> <li>– “FRONT SP” is set to “SMALL” (see page 73) and “LFE/BASS OUT” is set to “SWFR” (see page 72).</li> </ul> </li> </ul>
7ch Stereo CT LEVEL SL LEVEL SR LEVEL SB LEVEL PL LEVEL PR LEVEL	<p>7-channel stereo center, surround left, surround right, surround back, presence left and presence right levels. Adjusts the volume level of each channel in the 7-channel stereo mode. The available parameters differ depending on the setting of the speakers.</p> <hr/> <p>Control range: 0 to 100%</p>
2ch Enhancer 7ch Enhancer	<p>2-channel and 7-channel Compressed Music Enhancer effect level. The high-frequency signals of some sources may be emphasized too much. In this case, set the effect level to “LOW”.</p> <hr/> <p>Choices: <b>HIGH</b>, LOW</p> <hr/> <ul style="list-style-type: none"> <li>• Select “HIGH” for a high effect level.</li> <li>• Select “LOW” for a low effect level.</li> </ul>

## ■ Selecting decoders used with sound field programs (Decoder Type)

Use this feature to select the desired decoder used with MOVIE sound field programs (except “Mono Movie”). See page 45 for details about MOVIE sound field program.



### Available decoders

Decoder	Functions
PRO LOGIC	Dolby Pro Logic processing for any sources
PLIIx Movie PLII Movie	Dolby Pro Logic IIX (or Dolby Pro Logic II) processing for movie sources. The Pro Logic IIX decoder is not available when “SB L/R SP” is set to “NONE” (see page 73).
Neo:6 Cinema	DTS processing for movie sources

## Selecting decoders





### ■ Selecting decoders for 2-channel sources (surround decode mode)

Use this feature to play back sources with selected decoders. You can play back 2-channel sources on multi-channels.

**Set the operation mode selector to  AMP and then press  SUR. DECODE repeatedly on the remote control to select the desired surround decoder.**

You can select from the following modes depending on the type of source you are playing and your personal preference.



You can change the decoder parameter settings. Press DISPLAY and then  /  repeatedly on the remote control to select the desired decoder parameter. You can change the value of the selected parameter by pressing  /  repeatedly on the remote control.

## Decoder descriptions

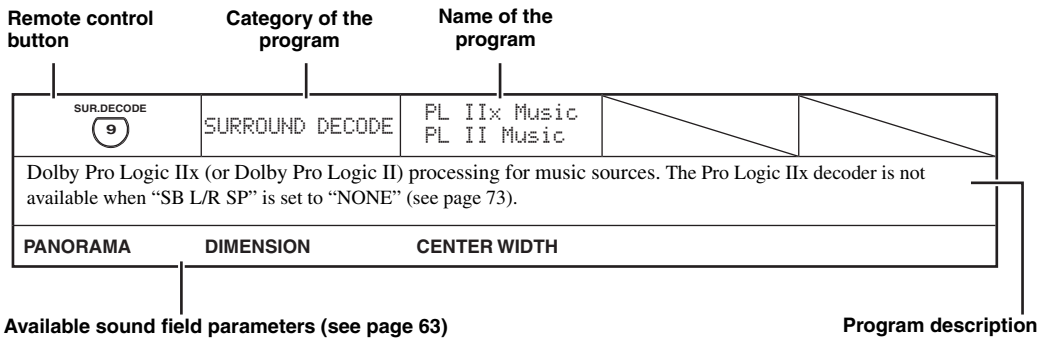

SUR.DECODE 9	SURROUND DECODE	PRO LOGIC		
Dolby Pro Logic processing for any sources.				

SUR.DECODE 9	SURROUND DECODE	PLIIX Movie PL II Movie		
Dolby Pro Logic IIX (or Dolby Pro Logic II) processing for movie sources. The Pro Logic IIX decoder is not available when "SB L/R SP" is set to "NONE" (see page 73).				

SUR.DECODE 9	SURROUND DECODE	PLIIX Music PL II Music		
Dolby Pro Logic IIX (or Dolby Pro Logic II) processing for music sources. The Pro Logic IIX decoder is not available when "SB L/R SP" is set to "NONE" (see page 73).				
PANORAMA	DIMENSION	CENTER WIDTH		

SUR.DECODE 9	SURROUND DECODE	PLIIX Game PL II Game		
Dolby Pro Logic IIX (or Dolby Pro Logic II) processing for game sources. The Pro Logic IIX decoder is not available when "SB L/R SP" is set to "NONE" (see page 73).				

SUR.DECODE 9	SURROUND DECODE	Neo:6 Cinema		
DTS processing for movie sources.				

SUR.DECODE 9	SURROUND DECODE	Neo:6 Music		
DTS processing for music sources.				
<b>C. IMAGE</b>				

SUR.DECODE 9	SURROUND DECODE	Neural Sur. (U.S.A. and Canada models only)		
Neural Surround processing for any sources. The Neural Surround decoder is compatible with PCM signals (32 kHz, 44.1 kHz, 48 kHz, 64 kHz, 88.2 kHz and 96 kHz) and analog 2-channel input sources. When Neural Surround-incompatible signals are being input while the Neural Surround decoder is selected, multi-channel sources are decoded straight into the appropriate channels without any additional effect processing and the Neural Surround-incompatible PCM signals are played back in stereo. The Neural Surround decoder is especially suitable for the XM HD Surround program of XM Satellite Radio.				

When you select the surround decode mode for Dolby Digital, DTS or DTS 96/24 sources, this unit automatically selects "SURROUND DECODE Dolby Digital", "SURROUND DECODE DTS" or "SURROUND DECODE DTS 96/24" program.

## Decoder parameter descriptions

Decoder parameter	Features
PRO LOGIC IIx Music PRO LOGIC II Music PANORAMA	Pro Logic IIx Music and Pro Logic II Music panorama. Sends stereo signals to the surround speakers as well as the front speakers for a wraparound effect.  Choices: <b>OFF</b> , ON
PRO LOGIC IIx Music PRO LOGIC II Music DIMENSION	Pro Logic IIx Music and Pro Logic II Music dimension. Adjusts the sound field either towards the front or towards the rear.  Control range: -3 (towards the rear) to +3 (towards the front)  Initial setting: STD (standard)
PRO LOGIC IIx Music PRO LOGIC II Music CENTER WIDTH	Pro Logic IIx Music and Pro Logic II Music center width. Moves the center channel output completely towards the center speaker or towards the front left and right speakers. A larger value moves the center channel output towards the front left and right speakers.  Control range: 0 (center channel sound is output only from the center speaker) to 7 (center channel sound is output only from the front left and right speakers)  Initial setting: 3
DTS Neo:6 Music C. IMAGE	DTS Neo:6 Music center image. Adjusts the front left and right channel output relative to the center channel to make the center channel more or less dominant as necessary.  Control range: 0.0 to 1.0  Initial setting: 0.3



# Customizing this unit (MANUAL SETUP)

You can use the following parameters in “SET MENU” to adjust a variety of system settings and customize the way this unit operates. Change the initial settings (indicated in bold under each parameter) to reflect the needs of your listening environment.

## ■ Auto setup AUTO SETUP

Use this feature to automatically adjust speaker and system parameters (see page 28).

## ■ Manual setup MANUAL SETUP

Use this feature to manually adjust speaker and system parameters.

### Sound menu 1 SOUND MENU

Use this menu to manually adjust any speaker settings, alter the quality and tone of the sound output by the system or compensate for video signal processing delays when using LCD monitors or projectors.

Parameter	Features	Page
A)SPEAKER SET	Selects the size of each speaker, the speakers for low-frequency signal output, the crossover frequency, and the assignment of the EXTRA SP terminal.	72
B)SPEAKER LEVEL	Adjusts the output level of each speaker.	74
C)SP DISTANCE	Adjusts the distance of each speaker.	75
D)EQUALIZER	Adjusts the tonal quality of the center speaker.	75
E)LFE LEVEL	Adjusts the output level of the LFE channel for Dolby Digital or DTS signals.	76
F)DYNAMIC RANGE	Adjusts the dynamic range of Dolby Digital or DTS signals.	76
G)AUDIO SET	Adjusts the muting level, audio delay, maximum volume level and initial volume level.	76
H)HDMI SET	Selects the component to play back HDMI audio signals.	77
I)EXTD SUR.	Selects the mode of the decoders for the 6.1/7.1-channel playback.	77

### Input menu 2 INPUT MENU

Use this menu to manually reassign the input/output jacks, select the input mode or rename the input source.

Parameter	Features	Page
A)I/O ASSIGNMENT	Assigns the input/output jacks of this unit according to the component to be used.	78
B)INPUT RENAME	Changes the name of the input source.	79
C)VOLUME TRIM	Adjusts the output volume of each input source.	80
D)DECODER MODE	Selects the input mode for the sources connected to the DIGITAL INPUT jacks on the rear panel of this unit.	80
E)MULTI CH SET	Sets the input channel numbers and other parameters of the multi channel input.	80

**Option menu 3 OPTION MENU**

Use this menu to manually adjust the optional system parameters.

<b>Parameter</b>	<b>Features</b>	<b>Page</b>
A>DISPLAY SET	Adjusts the brightness of the display and converts video signals.	81
B>MEMORY GUARD	Locks sound field program parameters and other "SET MENU" settings.	82
C>AUDIO SELECT	Designates the default audio input jack select setting for the input sources when you turn on the power of this unit.	82
D>PARAM. INI	Initializes the parameters of a group of sound field programs.	82
E>ZONE 2 SET	Adjusts the Zone 2 parameters.	82
F>XM RADIO SET	Displays the current reception level of the XM Satellite Radio signals.	83
G>DOCK SET	Selects whether this unit charges the battery of the connected iPod or not when this unit is in the standby mode.	83

**■ Signal information SIGNAL INFO**

Use this feature to check audio and video signal information (see page 40).

## Using SET MENU

Use the remote control to access and adjust each parameter.



- You can change the “SET MENU” parameters while this unit is reproducing sound.
- Press **RETURN** to return to the previous menu level.

### 1 Set the operation mode selector to **AMP** and then press **SET MENU** to enter “SET MENU”.

The top “SET MENU” display appears in the OSD.

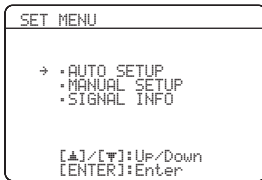

### 2 Press **UP/DOWN** to select “MANUAL SETUP” and then **ENTER** to enter “MANUAL SETUP”.

The “MANUAL SETUP” display appears in the OSD.

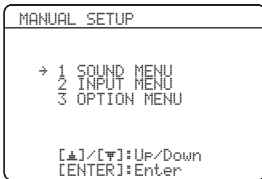

### 3 Press **UP/DOWN** repeatedly and then press **ENTER** to select and enter the desired menu.

The following displays are examples where “SOUND MENU” is selected.

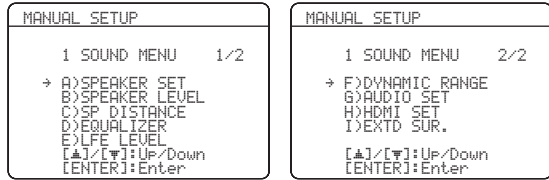

### 4 Press **UP/DOWN** repeatedly and then press **ENTER** to select and enter the desired submenu.

The following display is an example where “LFE LEVEL” is selected.



### 5 Press **UP/DOWN** to select the desired parameter and then **LEFT/RIGHT** to change the parameter settings.

### 6 Press **SET MENU** to exit from “SET MENU”.

# 1 SOUND MENU

Use this feature to manually adjust speaker settings or compensate for video signal processing delays when using LCD monitors or projectors. Most of the SOUND MENU parameters are set automatically when you run AUTO SETUP (see page 28).

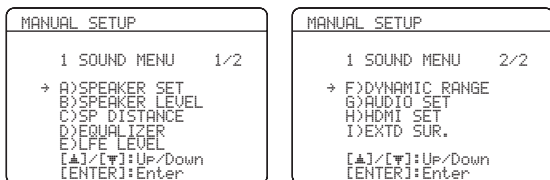

## ■ Speaker settings A) SPEAKER SET

Use this feature to manually adjust any speaker settings.

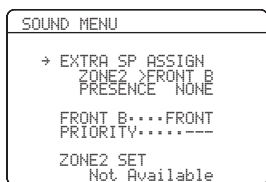

### Extra speakers assignment EXTRA SP ASSIGN

Selects the function of the speakers connected to the EXTRA SP terminals.

Choices: **FRONT B**, ZONE2, PRESENCE, NONE

#### When you use the alternative front speaker system (see page 38)

Select “FRONT B”.

#### When you use the Zone 2 speakers (see page 90)

Select “ZONE2” to set the function of the speakers to the Zone 2 speakers.

#### When you use the presence speakers (see page 12)

Select “PRESENCE” to set the function of the speakers to the presence speakers.

#### When you do not use the EXTRA SP terminals

Select “NONE” to deactivate the EXTRA SP terminals.

### Notes

- This parameter shares the value with the “EXTRA SP ASSIGN” parameter in “AUTO SETUP”.
- If you select “ON” in “BI-AMP” (see page 95), you cannot select “PRESENCE” or “ZONE2” in “EXTRA SP ASSIGN”.
- After changing the “EXTRA SP ASSIGN” setting, carry out “AUTO SETUP” again (See page 28).

## FRONT B speakers setting FRONT B

The “FRONT B” parameter is available only when you set “EXTRA SP ASSIGN” to “FRONT B”.

Use this feature to select the location of the FRONT B speakers.

Choices: **FRONT**, ZONE B

- Select “FRONT” to turn FRONT A and B on or off when the FRONT B speakers are set in the main room.
- Select “ZONE B” if the FRONT B speakers are set in another room. If FRONT A is turned off and FRONT B is turned on, all the speakers including the subwoofer in the main room are muted and this unit outputs sound at the FRONT B terminals only.

### Notes

- If you connect headphones to the PHONES jack of this unit, the sound is output from both the headphones and the EXTRA SP terminals when “FRONT B” is set to “ZONE B”.
- If a DSP program is selected when “FRONT B” is set to “ZONE B”, this unit automatically enters the Virtual CINEMA DSP mode (see page 46).

## Presence/Surround back channel priority PRIORITY

The “PRIORITY” parameter is available only when you set “EXTRA SP ASSIGN” to “PRESENCE”.

Use this feature to prioritize either the presence or the surround back speakers when playing sources that contain surround back channel signals using the CINEMA DSP sound field programs.

Choices: PRNS, **SUR. B**

- Select “PRNS” to use the presence speakers even when surround back channel signals are input. The signals for the surround back channels will be output from the surround speakers.
- Select “SUR. B” to use the surround back speakers when surround back channel signals are detected in a CINEMA DSP program. The presence channel signals are output from the front speakers.

Woofers section of a speaker is 16 cm (6.5 in) or larger: large  
 Woofers section of a speaker is smaller than 16 cm (6.5 in): small

**Front speakers** FRONT SP

Choices: SMALL, **LARGE**

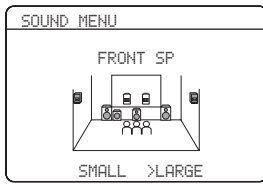
**When the front speakers are large**

Select "LARGE" (large).

**When the front speakers are small**

Select "SMALL" (small).

**Note**

When "LFE/BASS OUT" is set to "FRNT" (see page 72), you can select only "LARGE" in "FRONT SP". If the value of "FRONT SP" is set to a setting other than "LARGE" in advance, this unit automatically changes the value to "LARGE".

**Center speaker** CENTER SP

Choices: NONE, **SML**, LRG

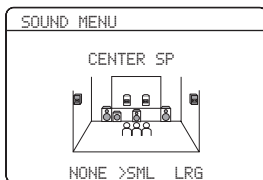
**When the center speaker is large**

Select "LRG" (large).

**When the center speaker is small**

Select "SML" (small).

**When you do not use the center speaker**

Select "NONE" (none). The center channel signals are directed to the front left and right speakers.

**Surround left/right speakers** SUR. L/R SP

Choices: NONE, **SML**, LRG

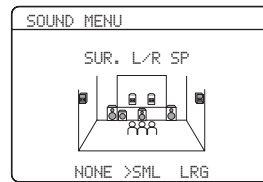
**When the surround speakers are large**

Select "LRG" (large).

**When the surround speakers are small**

Select "SML" (small).

**When you do not use the surround speakers**

Select "NONE" (none). This unit is set to the Virtual CINEMA DSP mode (see page 46), and "SUR. B L/R SP" is automatically set to "NONE".

**Surround back left/right speakers** SUR. B L/R SP

Choices: NONE, SMLx1, **SMLx2**, LRGx1, LRGx2

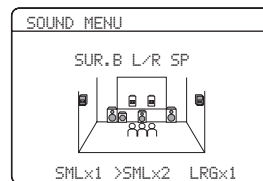
**When the surround back left and right speakers are large**

Select "LRGx2" (large x 2).

**When the single surround back speaker is large**

Select "LRGx1" (large x 1).

**When the surround back left and right speakers are small**

Select "SMLx2" (small x 2).

**When the single surround back speaker is small**

Select "SMLx1" (small x 1).

**When you do not use the surround back speakers**

Select "NONE" (none). The surround back channel signals are directed to the surround left and right speakers.

**LFE/Bass out** LFE/BASS OUT

Use this feature to select the speakers that output the LFE (low-frequency effect) and the low-frequency signals.

Choices: SWFR, FRNT, **BOTH**

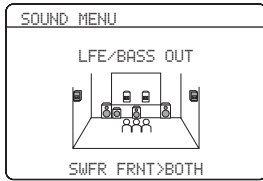

**When a subwoofer is connected to this unit and you want to get natural bass sound**

Select “SWFR” (subwoofer). The LFE signals as well as the low-frequency signals of other speakers set to “SML” (or “SMALL”) are directed to the subwoofer.

**When a subwoofer is connected to this unit and you want to get rich bass sound**

Select “BOTH” (both). The low-frequency signals of any source are output from the subwoofer. The LFE signals as well as the low-frequency signals of other speakers set to “SML” (or “SMALL”) are directed to the subwoofer. The low-frequency signals of the front left and right channels are directed to the front left and right speakers and the subwoofer regardless of the “FRONT SP” setting.

**When you do not use a subwoofer**

Select “FRNT” (front). The LFE signals, the low-frequency signals of the front left and right channels, and the low-frequency signals of other speakers set to “SML” (or “SMALL”) are all directed to the front left and right speakers regardless of the “FRONT SP” setting.

**Bass crossover** CROSSOVER

Use this feature to select the crossover frequency of all the speakers set to “SML” (or “SMALL”) or to “NONE” in “SPEAKER SET” (see page 73). All frequencies below the selected frequency will be sent to the subwoofer or to the speakers set to “LRG” (or “LARGE”) in “SPEAKER SET” (see page 73).

Choices: 40Hz, 60Hz, **80Hz**, 90Hz, 100Hz, 110Hz, 120Hz, 160Hz, 200Hz

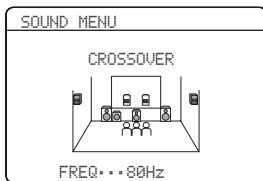

**Subwoofer phase** SUBWOOFER PHASE

Use this feature to switch the phase of your subwoofer if bass sounds are lacking or unclear.

Choices: **NORMAL**, REVERSE

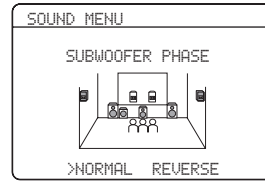

- Select “NORMAL” if you do not want to reverse the phase of your subwoofer.
- Select “REVERSE” to reverse the phase of your subwoofer.

■ **Speaker level** B>SPEAKER LEVEL

Use this feature to manually adjust the output level of each speaker.

Control range: -10.0 to +10.0 dB

Control step: 0.5 dB

Initial setting: 0.0 dB

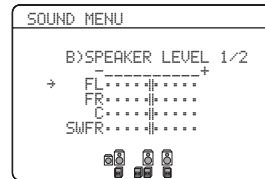

SPEAKER LEVEL	Adjusted speaker
FL	Front left speaker
FR	Front right speaker
C	Center speaker
SWFR	Subwoofer
SL	Surround left speaker
SR	Surround right speaker
SBR	Surround back right speaker
SBL	Surround back left speaker
PL	Presence left speaker
PR	Presence right speaker

**Notes**

- The available speaker channels differ depending on the setting of the speakers.
- Instead of “SBL” and “SBR”, “SB” is displayed if “SB.L/R SP” is set to either “SMLx1” or “LRGx1” (see page 73).

### ■ Speaker distance C)SP DISTANCE

Use this feature to manually adjust the distance of each speaker and the delay applied to the respective channel. Ideally, each speaker should be the same distance from the main listening position. However, this is not possible in most home situations. Thus, a certain amount of delay must be applied to the sound from each speaker so that all sounds will arrive at the listening position at the same time.

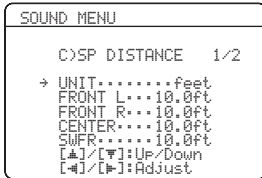

#### Unit UNIT

Choices: meters (m), feet (ft)

Initial setting:

[U.S.A. and Canada models]: feet (ft)

[Other models]: meters (m)

- Select “meters” to adjust speaker distances in meters.
- Select “feet” to adjust speaker distances in feet.

#### Speaker distances

Control range: 0.30 to 24.00 m (1.0 to 80.0 ft)

Control step: 0.10 m (0.5 ft)

Initial setting:

FRONT L/FRONT R/CENTER/SWFR/SUR. L/SUR. R/

PRNS L/PRNS R: 3.00 m (10.0 ft)

SB L/SB R: 2.10 m (7.0 ft)

SP DISTANCE	Adjusted speaker
FRONT L	Front left speaker
FRONT R	Front right speaker
CENTER	Center speaker
SWFR	Subwoofer
SUR. L	Surround left speaker
SUR. R	Surround right speaker
SB L	Surround back left speaker
SB R	Surround back right speaker
PRNS L	Presence left speaker
PRNS R	Presence right speaker

#### Notes

- The available speaker channels differ depending on the setting of the speakers.
- Instead of “SB L” and “SB R”, “SB” is displayed if “SB L/R SP” is set to either “SMLx1” or “LRGx1” (see page 73).

### ■ Equalizer D)EQUALIZER

Use this feature to select the parametric equalizer or the graphic equalizer.

#### Equalizer type select EQ TYPE SELECT

Use this feature to select the type of equalizer.

Choices: AUTO PEQ, CENTER GEQ, EQ OFF

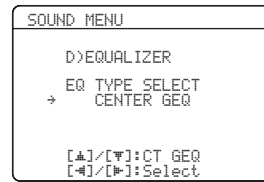

- Select “AUTO PEQ” to use the parametric equalizer adjusted in “AUTO SETUP” (see page 28).
- Select “CENTER GEQ” to adjust the built-in 5-frequency band graphic equalizer so that the tonal quality of the center speaker matches that of the front left and right speakers. Press  $\odot/\Delta/\nabla$  to display the graphic equalizer screen.
- Select “EQ OFF” to deactivate the equalizing feature.

#### Note

When you carry out “AUTO SETUP” in advance (see page 28), “AUTO PEQ” is automatically selected as the default setting.

#### Test tone TEST

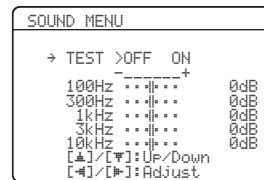

Use this feature to make adjustments for “CENTER GEQ” while listening to a test tone.

Choices: OFF, ON

- Select “OFF” to stop test tones and output the currently selected source component.
- Select “ON” to output test tones from the center and front left speakers.

### Center graphic equalizer CENTER GEQ

Use to match the tonal quality of the center speaker with that of the front left and right speakers. You can adjust 5 frequency bands (100 Hz, 300 Hz, 1 kHz, 3 kHz and 10 kHz).

Control range: -6.0 to +6.0 dB

Control step: 0.5 dB

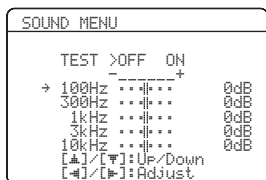

Press **⏪**/**⏩** to select a frequency band and **⏴**/**⏵** to adjust the selected frequency band.

#### Note

The “CENTER GEQ” parameter can be adjusted only when “CENTER GEQ” is selected in “EQ TYPE SELECT”.

### Low-frequency effect level

#### E>LFE LEVEL

Use this feature to adjust the output level of the LFE (low-frequency effect) channel according to the capacity of your subwoofer or headphones. The LFE channel carries low-frequency special effects which are only added to certain scenes. This setting is effective only when this unit decodes Dolby Digital or DTS signals.

Control range: -20 to 0 dB

Control step: 1 dB



#### Speaker SPEAKER

Adjusts the speaker LFE level.

#### Headphone HEADPHONE

Adjusts the headphone LFE level.

#### Note

Depending on the settings of “LFE/BASS OUT” (see page 72), some signals may not be output at the SUBWOOFER OUTPUT jack.

### Dynamic range F>DYNAMIC RANGE

Use this feature to select the amount of dynamic range compression to be applied to your speakers or headphones. This setting is effective only when this unit is decoding Dolby Digital and DTS signals.

Choices: MIN, STD, **MAX**

- Select “MIN” (minimum) if you regularly listen at low volume levels.
- Select “STD” (standard) for general use.
- Select “MAX” (maximum) to preserve the greatest amount of dynamic range.

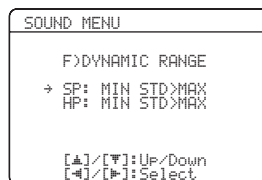

#### Speaker SP

Adjusts the speaker compression.

#### Headphone HP

Adjusts the headphone compression.

### Audio settings G>AUDIO SET

Use this feature to adjust the overall audio settings of this unit.

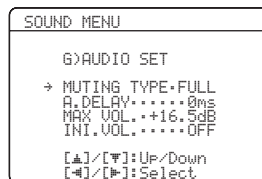

#### Muting type MUTING TYPE

Use this feature to adjust how much the mute function reduces the output volume (see page 40).

Choices: **FULL**, -20dB

- Select “FULL” to completely mute all the audio output.
- Select “-20dB” to reduce the current volume by 20 dB.

#### Audio delay AUDIO DELAY

Use this feature to delay the sound output and synchronize it with the video image. This may be necessary when using certain LCD monitors or projectors.

Control range: 0 to 160 ms

Control step: 1 ms



### Maximum volume MAX VOL.

Use this feature to set the maximum volume level in the main zone. This feature is useful to avoid the unexpected loud sound by mistake. For example, the original volume range is 16.5 dB to -80.0 dB. However, when "MAX VOL." is set to -5.0 dB, the volume range becomes -5.0 dB to -80.0 dB.

Control range: **16.5 dB**, 15.0 dB to -30.0 dB

Control step: 5.0 dB

#### Notes

- When this unit is in the auto setup procedure, the volume level is automatically set to 0 dB regardless of the current "MAX VOL." setting.
- The "MAX VOL." setting takes priority over the "Initial Volume" setting. For example, if "INI VOL." is set to -20.0 dB and "MAX VOL." is set to -30.0 dB, the volume level is automatically set to -30.0 dB when you turn on the power of this unit next time.
- Use "MAX VOL." in "ZONE2 SET" to set the initial volume level in Zone 2 (see page 83).

### Initial volume INI VOL.

Use this feature to set the volume level of the main zone when the power of this unit is turned on.

Choices: **Off**, -80.0 dB to +16.5 dB

Control step: 0.5 dB

#### Notes

- The "MAX VOL." setting takes priority over the "INI VOL." setting.
- Use "INI VOL." in "ZONE2 SET" to set the initial volume level in Zone 2 (see page 83).

### ■ HDMI setting H>HDMI SET

Use this feature to select the component to play back HDMI audio signals.



### Support audio SUPPORT AUDIO

Use this feature to select whether to play back HDMI audio signals on this unit or on another HDMI component connected to the HDMI OUT jack on the rear panel of this unit.

Choices: **RX-V661**, OTHER

- Select "RX-V661" to play back HDMI audio signals on this unit. The HDMI audio signals input at the HDMI IN jacks of this unit are not output to the HDMI component connected to the HDMI OUT jack on the rear panel of this unit.
- Select "OTHER" to play back HDMI audio signals on another HDMI component connected to the HDMI OUT jack.

#### Note

The HDMI video signals input at the HDMI IN 1 or HDMI IN 2 jack of this unit are always output at the HDMI OUT jack of this unit.

### ■ Extended surround decoders

#### I>EXTD SUR.

Use this feature to enjoy 6.1/7.1-channel playback for multi-channel sources using the Dolby Pro Logic IIX, Dolby Digital EX or DTS-ES decoders by using the connected surround back speakers.

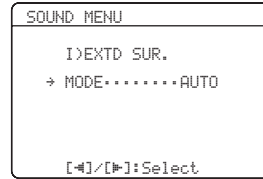

#### Mode MODE

Use this feature to select the mode of the decoder driving. Choices: **AUTO**, ON, OFF

- Select "AUTO" to activate the optimum decoder to play back the signal in 6.1/7.1 channels when a signal flag that can be recognized by this unit is input.
- Select "ON" to play back multi-channel sources using the selected decoder type in "TYPE".
- Select "OFF" not to use the decoders to create 6.1/7.1 channels.

#### Decoder type TYPE

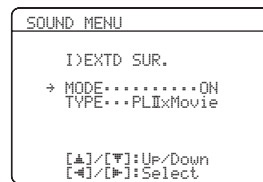

Use this feature to select the decoders used to play back multi-channel sources when you select "ON" in "MODE".

Choices: **PLIIXMovie**, PLIIXMusic, EX/ES, EX

- Select "PLIIXMovie" to play back Dolby Digital or DTS signals in 7.1 channels using the Pro Logic IIX movie decoder.
- Select "PLIIX Music" to play back Dolby Digital or DTS signals in 6.1/7.1 channels using the Pro Logic IIX music decoder.
- Select "EX/ES" to play back Dolby Digital or DTS signals in 6.1/7.1 channels using the Dolby Digital EX or DTS-ES decoder.
- Select "EX" to play back Dolby Digital or DTS signals in 6.1/7.1 channels using the Dolby Digital EX decoder.



Use this feature to activate the desired decoder manually when this unit cannot detect the signal flag encoded to the input sources correctly.

**Notes**

- The available decoders vary depending on the setting of the speakers and the input sources.
- 6.1/7.1-channel playback is not possible in the following cases:
  - when “SUR. L/R SP” (see page 73) or “SUR. B L/R SP” (see page 73) is set to “NONE”.
  - when the component connected to the MULTI CH INPUT jacks is being played.
  - when the source being played does not contain surround left and right channel signals.
  - when a Dolby Digital KARAOKE source is being played.
  - when this unit is in the stereo playback, Compressed Music Enhancer (see page 46) or Pure Direct (see page 48) mode.
  - when “BI-AMP” is set to “ON” (see page 95).
- When this unit is turned off, this setting will be reset to “AUTO”.

## 2 INPUT MENU

Use this menu to reassign the input/output jacks, select the input mode or rename the input source.

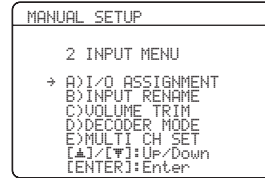

■ **Input/output assignment**

A) I/O ASSIGNMENT

Use this feature to assign the input/output jacks according to the component to be used if the initial settings of this unit do not correspond to your needs. Change the following parameters to reassign the respective jacks and effectively connect more components.

Once the input/output jacks are reassigned, you can select the corresponding component by using the INPUT selector on the front panel (or the input selector buttons on the remote control).



The input source name in parentheses indicates the default assigned input source.

**For COMPONENT VIDEO jacks A, B and C**

CMPNT-V INPUT

- Choices: [A] **DVD**, DTV/CBL, V-AUX, DVR, VCR  
 [B] DVD, **DTV/CBL**, V-AUX, DVR, VCR  
 [C] DVD, DTV/CBL, V-AUX, **DVR**, VCR

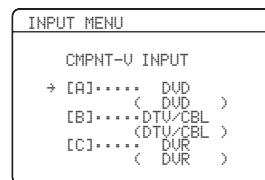

### For OPTICAL OUTPUT jack 1

#### OPTICAL OUT

Choices: (1) PHONO, CD, **MD/CD-R**, DVD, DTV/CBL, V-AUX, VCR, DVR

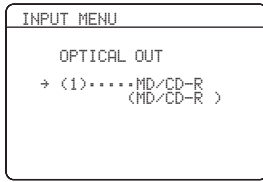

#### Notes

- You cannot select a specific item more than once for the same type of jack.
- When you connect a component to both the DIGITAL INPUT (COAXIAL) and DIGITAL INPUT (OPTICAL) jacks, priority is given to the signals input at the DIGITAL INPUT (COAXIAL) jack.

### For OPTICAL INPUT jacks 2, 3 and 4

#### OPTICAL IN

Choices: (2) PHONO, CD, **MD/CD-R**, DVD, DTV/CBL, DVR, VCR

(3) PHONO, CD, MD/CD-R, **DVD**, DTV/CBL, DVR, VCR

(4) PHONO, CD, MD/CD-R, DVD, **DTV/CBL**, DVR, VCR

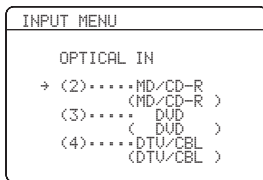

### For COAXIAL INPUT jacks 5 and 6

#### COAXIAL IN

Choices: (5) PHONO, **CD**, MD/CD-R, DVD, DTV/CBL, V-AUX, DVR, VCR

(6) PHONO, CD, MD/CD-R, **DVD**, DTV/CBL, V-AUX, DVR, VCR

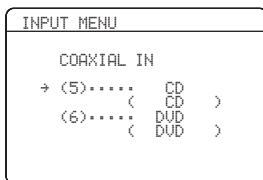

### For HDMI IN jacks 1 and 2

#### HDMI IN

Choices: [IN1] **DVD**, DTV/CBL, V-AUX, DVR, VCR

[IN2] DVD, **DTV/CBL**, V-AUX, DVR, VCR

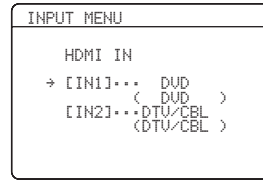

### Input rename B) INPUT RENAME

Use this feature to change the name of the input source that appears in the OSD and in the front panel display.

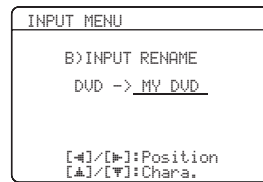

- This feature is useful when you change the input or output assignment for digital jacks and component video input jacks.
- You can only rename DOCK when iPod is stationed in the Yamaha Universal Dock connected to this unit.

- 1 Press one of the input selector buttons (A) on the remote control to select the input source you want to change the name of.
- 2 Press  $\text{D}\triangleleft/\triangleright$  to place the “\_” (underscore) under the space or the character you want to edit.
- 3 Press  $\text{D}\triangle/\nabla$  to select the character you want to use and then press  $\text{D}\triangleleft/\triangleright$  to move to the next space.

#### Notes

- You can use up to 8 characters for each input.
- Press  $\text{D}\nabla$  to change the character in the following order, or press  $\text{D}\triangle$  to go in the reverse order: A to Z, 0 to 9, a to z, symbols (#, \*, -, +, etc.), space.

- 4 Repeat steps 1 through 3 to rename each input source.
- 5 Press  $\text{D}\text{ENTER}$  on the remote control to exit from “INPUT RENAME”.

■ **Volume Trim** C>VOLUME TRIM

Use this feature to adjust the output level of each input source. This is useful if you want to balance the level of each input source to avoid sudden changes in volume when switching between input sources.

Choices: XM, TUNER, PHONO, CD, MD/CD-R, DVD, DTV/CBL, VCR, DVR, V-AUX, DOCK, MULTI CH

Control range: -6.0 to +6.0 dB

Control step: 0.5 dB

Initial setting: 0.0 dB

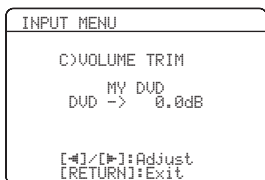

- You can adjust the value for DOCK only when iPod is stationed to the Yamaha Universal Dock connected to this unit.
- The default name (“DVD” in the display example above) and the new name (“MY DVD”) of the selected input source appears in the OSD.

■ **Decoder mode** D>DECODER MODE

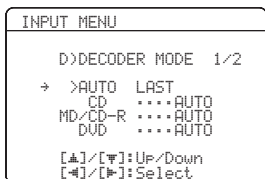

**Decoder select mode**

Use this feature to designate the default decoder mode for the input sources connected to the DIGITAL INPUT jacks when you turn on the power of this unit.

Choices: **AUTO**, LAST

- Select “AUTO” to if you want this unit to automatically detect the type of input signals and select the appropriate decoder mode.
- Select “LAST” to if you want this unit to automatically select the last decoder mode used for the connected input source.

**DTS decoder prioritize setting**

Choices: **AUTO**, DTS

- Select “AUTO” if you want this unit to automatically detect input signal types and select the appropriate input mode.
- Select “DTS” if you want this unit to select DTS as the input mode.

■ **Multi channel input settings**

E>MULTI CH SET

Use this feature to set the function of the multi channel input.

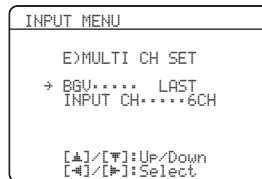

**BGV** BGV

Use this feature to select the video source played in the background of the sources input from the MULTI CH INPUT jacks.

Choices: DVD, DTV/CBL, V-AUX, DVR, VCR, **LAST**, OFF

- Select “LAST” to set this unit to automatically select the last selected video source as the background video source.
- Select “OFF” to set this unit not to play the video source in the background.

**Input channels** INPUT CH

Use this setting to select the number of channels input from an external decoder.

Choices: **6CH**, 8CH

- Select “6CH” if you input 6-channel signals.
- Select “8CH” if you input 8-channel signals.

**Front input** FRONT

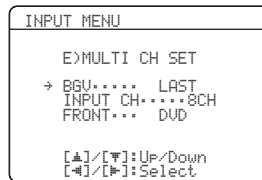

If you selected 8ch in “INPUT CH”, you can select the analog jacks at which the front signals from an external decoder will be input.

Choices: CD, MD/CD-R, **DVD**, DTV/CBL, V-AUX, DVR, VCR



See page 22 for the connection information.

**Note**

The “FRONT” parameter appears only when you set “INPUT CH” to “8CH”.

## 3 OPTION MENU

Use this menu to adjust the optional system parameters.

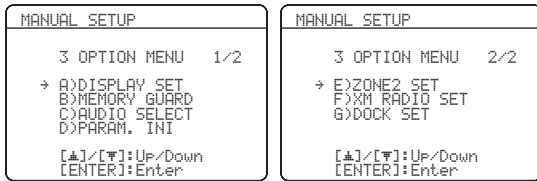

### ■ Display settings A)DISPLAY SET

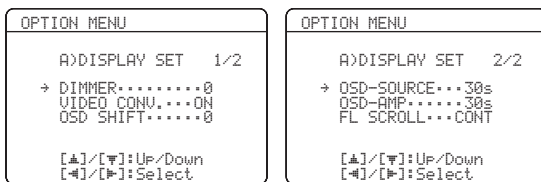

#### Dimmer DIMMER

Use this feature to adjust the brightness of the front panel display.

Control range: -4 to 0

Control step: 1

- Press **⊖** to make the front panel display dimmer.
- Press **⊕** to make the front panel display brighter.

#### Video conversion VIDEO CONV.

Use this feature to set whether to convert the video signals input at the VIDEO, S VIDEO and COMPONENT VIDEO jacks.

Choices: **ON**, **OFF**

- Select “ON” to convert composite, S-video and component video signals interchangeably.
- Select “OFF” not to convert any signals.

#### Notes

- This unit does not convert 480 line video signals and 576 line video signals interchangeably.
- The converted video signals are only output at the MONITOR OUT jacks. When recording a video source, you must make the same type of video connections between each component.
- When composite video or S-video signals from a VCR are converted to component video signals, the picture quality may suffer depending on your VCR.
- Unconventional signals input at the composite video or S-video jacks cannot be converted or may be output abnormally. In such cases, set “VIDEO CONV.” to “OFF”.
- When non-standard video signals (such as video signals from a game console) are input, this unit may not convert the signals even if you set “VIDEO CONV.” to “ON”.

#### OSD shift OSD SHIFT

Use this feature to adjust the vertical position of the OSD.

Control range: -5 (upward) to +5 (downward)

Control step: 1

Initial setting: 0

- Press **⊖** to raise the position of the OSD.
- Press **⊕** to lower the position of the OSD.

#### Source feature OSD display time

##### OSD-SOURCE

Use this feature to set the amount of time to display the XM Satellite Radio information or iPod menu in the OSD after you perform a certain operation.

Choices: **ON**, 10s, **30s**

- Select “ON” to display the OSD continuously during an operation.
- Select “10s” to turn off the OSD 10 seconds after you perform a certain operation.
- Select “30s” to turn off the OSD 30 seconds after you perform a certain operation.

#### Amplifier function OSD display time

##### OSD-AMP

Use this feature to set the amount of time to display the status and sound field parameters information screen after you perform a certain operation.

Choices: **ON**, 10s, **30s**

- Select “ON” to display the OSD constantly during an operation.
- Select “10s” to turn off the OSD 10 seconds after you perform a certain operation.
- Select “30s” to turn off the OSD 30 seconds after you perform a certain operation.

#### Front panel display scroll FL SCROLL

Use this feature to set whether to display the information (such as a song title or a channel name) in the front panel display in a continuous manner or by the first 14 alphanumeric characters after scrolling all characters once when “XM” or “DOCK” is selected as the input source.

Choices: **CONT**, **ONCE**

- Select “CONT” to display the operation status in the front panel display in a continuous manner.
- Select “ONCE” to display the operation status in the front panel display by the first 14 alphanumeric characters after scrolling all characters once.

### ■ Memory guard B>MEMORY GUARD

Use this feature to prevent accidental changes to DSP program parameter values and other system settings.

Choices: **OFF**, ON

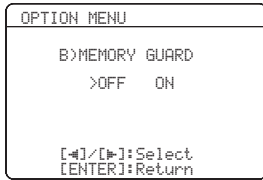

- Select “OFF” to turn off the “MEMORY GUARD” feature.
- Select “ON” to protect:
  - sound field program parameters
  - all “SET MENU” items
  - all speaker levels
  - SCENE template parameters

#### Note

When “MEMORY GUARD” is set to “ON”, you cannot select and adjust any other “SET MENU” items.

### ■ Audio select C>AUDIO SELECT

Use this feature to designate the default audio input jack select setting for the input sources when you turn on the power of this unit.

Choices: **AUTO**, LAST

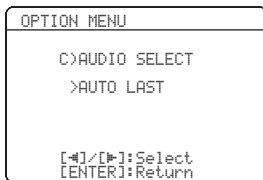

- Select “AUTO” if you want this unit to automatically detect the type of input signals and select the appropriate audio input jack select setting.
- Select “LAST” if you want this unit to automatically select the last audio input jack select setting used for the connected input source.

### ■ Parameter initialization D>PARAM. INI

Use this feature to initialize the parameters of each sound field program within a sound field program group. When you initialize a sound field program group, all of the parameter values within that group revert to their initial factory settings.

Press the corresponding sound field program selector buttons on the remote control to select the sound field program that you want to initialize.

An asterisk (\*) appears to the left of the sound field program names that have been changed from their initial factory settings.

Choices: CLASSICAL, LIVE/CLUB, ENTERTAINMENT, MOVIE, STEREO, ENHANCER, SUR. DECODE



#### Notes

- You cannot automatically revert to the previous parameter settings once you initialize a sound field program group.
- You cannot separately initialize individual sound field programs.
- You cannot initialize any sound field program groups when “MEMORY GUARD” is set to “ON”.

### ■ Zone 2 settings E>ZONE2 SET

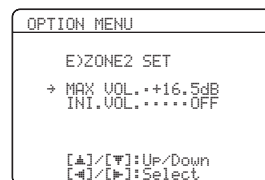

#### Zone 2 Maximum volume MAX VOL.

Use this feature to set the maximum volume level in the Zone 2.

Control range: **16.5 dB**, 15.0 dB to –30.0 dB

Control step: 5.0 dB

#### Notes

- The “MAX VOL.” setting takes priority over the “INI VOL.” setting. For example, when “INI VOL.” is set to –20.0 dB and then “MAX VOL.” is set to –30.0 dB, the volume level is automatically set to –30.0 dB when you turn on the power of this unit next time.
- The “MAX VOL.” setting does not affect the output level at the “ZONE 2 OUT” jacks.

**Zone 2 Initial volume** INI VOL.

Use this feature to set the volume level of Zone 2 when the power of this unit is turned on.

Choices: **Off**, -80.0 dB to +16.5 dB

Control step: 0.5 dB

**Notes**

- The “MAX VOL.” setting takes priority over the “INI VOL.” setting.
- When you select “FRONT B”, “PRNS” or “NONE” in “EXTRA SP ASSIGN” (see page 72), “Zone 2 SP Not Assigned” appears in the OSD and the “ZONE2 SET” parameter is not available.
- The “INI VOL.” setting does not affect the output level at the “ZONE 2 OUT” jacks.

■ **XM Radio setting** F>XM RADIO SET

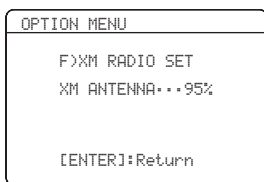

**XM Radio antenna** XM ANTENNA

Use this feature to check the current reception level of the XM Satellite Radio signals (see page 53). For the best reception, orient the XM Mini-Tuner so that a value of 60% or more is displayed here.

Display status: NONE, 0 to 100%

**Note**

“NONE” is displayed if the XM Mini-Tuner Dock is not connected to this unit. In this case, check the antenna connections (see page 53).

■ **iPod universal dock setting** G>DOCK SET

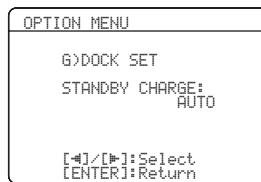

**Charge on standby** STANDBY CHARGE

Use this feature to select whether this unit charges the battery of the stationed iPod or not when this unit is in the standby mode (see page 58).

Choices: **AUTO**, **OFF**

- Select “AUTO” to charge the battery of the stationed iPod when this unit is turned on and in the standby mode.
- Select “OFF” to charge the battery of the stationed iPod only when this unit is turned on.

# Remote control features

In addition to controlling this unit, the remote control can also operate other audiovisual components made by Yamaha and other manufacturers. To control your TV or other components, you must set up the appropriate remote control code for each input source (see page 87).

## Using the remote control for the SCENE feature

### ■ Controlling the input source components in the SCENE mode

You can operate both this unit and the input source component by using the remote control. You must set the appropriate remote control code for each input source in advance (see page 87).

- 1 Press the desired **F SCENE** button on the remote control.
- 2 Press the desired buttons in the \* area below to control the input source component of the selected SCENE template.

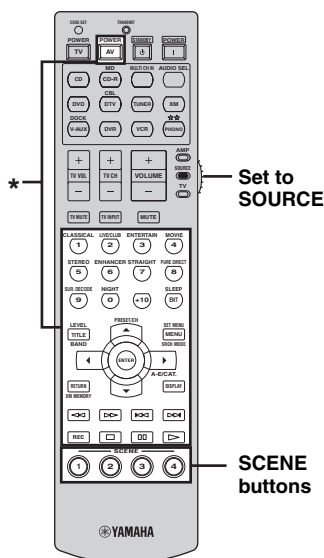

### Note

\* These buttons control the input source component. See page 86 for details of the function of each button.

### ■ Setting the input source of the customized SCENE template on the remote control

If you customize the input source of the selected SCENE template, you must set the input source of the SCENE template on the remote control to operate the input source component correctly.

- 1 Press the desired **F SCENE** button on the remote control.
- 2 Press and hold the **F SCENE** button and the desired input selector button (**A**).  
The **V TRANSMIT** indicator flashes twice.
- 3 Keep holding down the buttons pressed in step 2 until the **V TRANSMIT** indicator flashes twice again.

### Note

If the setting of the input source is not successful, the **V TRANSMIT** indicator flashes repeatedly. In this case, repeat the setup procedure.



## Controlling this unit, a TV, or other components

### Controlling this unit

Set the operation mode selector to **AMP** to control this unit.

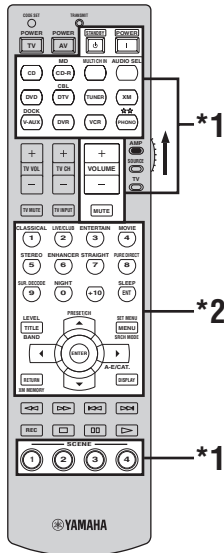

### Controlling a TV

Set the operation mode selector to **TV** to control your TV. To control your TV, you must set the appropriate remote control code for DTV/CBL or PHONO (see page 87). When you set the remote control codes for both DTV/CBL and PHONO, priority is given to the one set for DTV/CBL.

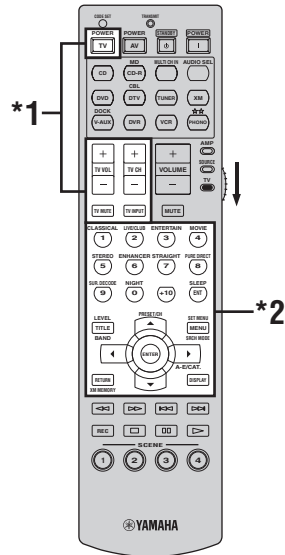

### Notes

- \*1 These buttons always control this unit regardless of the operation mode selector position.
- \*2 These buttons control this unit only when the component operation mode selector is set to **AMP**.

### Notes

- \*1 These buttons always control your TV regardless of the operation mode selector position.

Remote control	Digital TV/Cable TV
TV POWER	Turns the power on or off.
TV VOL +/-	Increases or decreases the volume level.
TV CH +/-	Changes the channel number.
TV MUTE	Mutes the audio output.
TV INPUT	Changes the input source.

- \*2 These buttons control your TV only when the operation mode selector is set to **TV**. For details, see the "Digital TV/Cable TV" column on page 86.

### ■ Controlling other components

Set the operation mode selector to **SOURCE** to control other components selected with the input selector buttons. You must set the appropriate remote control code for each input source in advance (see page 87). The following table shows the function of each control button used to control other components assigned to each input selector button. Be advised that some buttons may not correctly operate the selected component.

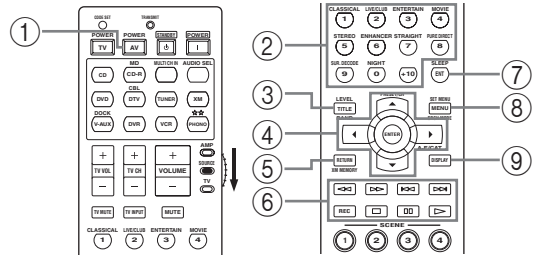

The remote control has 10 modes (input areas) to control components so that the remote control can operate up to 10 different components.

Remote control	DVD player/recorder	VCR	Digital TV/Cable TV	LD player	CD player	MD/CD recorder	Tuner	iPod
① AV POWER	Power *1	Power *1	Power *2	Power *1	Power *1	Power *1		
② 1-9, 0, +10	Numeric buttons	Numeric buttons	Numeric buttons	Numeric buttons	Numeric buttons	Numeric buttons	Preset stations (1-8)	
③ TITLE	Title						Band	
④ PRESET/CH $\Delta$	Up	VCR channel up	Up				Preset up (1-8)	Up
PRESET/CH $\nabla$	Down	VCR channel down	Down				Preset down (1-8)	Down
A-E/CAT. $\triangleleft$	Left		Left				Preset down (A-E)	Previous menu
A-E/CAT. $\triangleright$	Right		Right				Preset up (A-E)	Subsequent menu
ENTER	Enter		Enter					Subsequent menu
⑤ RETURN	Return		Return					
⑥ REC	Disc skip (player) Rec (recorder)	Rec	Rec *2		Disc skip	Rec		
$\triangleright$	Play	Play	Play *2	Play	Play	Play		Play (Play/pause)*4
$\triangleleft\triangleleft$	Search backward	Search backward	Search backward *2	Search backward	Search backward	Search backward		Search backward *3
$\triangleright\triangleright$	Search forward	Search forward	Search forward *2	Search forward	Search forward	Search forward		Search forward *3
$\parallel$	Pause	Pause	Pause *2	Pause	Pause	Pause		Pause (Play/pause)*4
$\triangleleft\triangleleft$	Skip backward	Skip backward	Skip backward *2	Skip backward	Skip backward	Skip backward		Skip backward
$\triangleright\triangleright$	Skip forward	Skip forward	Skip forward *2	Skip forward	Skip forward	Skip forward		Skip forward
$\square$	Stop	Stop	Stop *2	Stop	Stop	Stop		Stop
⑦ ENT	Title/Index	Enter	Enter	Chapter/Time	Index	Index		
⑧ MENU	Menu		Menu					Previous menu
⑨ DISPLAY	Display	Display	Display	Display	Display	Display		Display

#### Notes

\*1 This button is operational only when the original remote control supplied with the component has a POWER button.

\*2 These buttons operate your VCR or DVD recorder only when you set the appropriate remote control code for DVR (see page 87).

\*3 Press and hold to search backward or forward.

\*4 Simple remote mode (see page 58).

## Setting remote control codes

You can control other components by setting the appropriate remote control codes. For a complete list of available remote control codes, refer to “List of remote control codes” at the end of this manual.

### Remote control code default settings

Input source	Component category	Manufacturer	Default code
CD	CD	YAMAHA	62000
MD/CD-R	CD-R	YAMAHA	71292
DVD	DVD	YAMAHA	42000
DTV/CBL	–	–	–
TUNER	TUNER	YAMAHA	82005
XM	TUNER	YAMAHA	82006
V-AUX	OTHER AUDIO ACCESSORIES (iPod)	YAMAHA	82000
DVR	DVR	YAMAHA	52001
VCR	–	–	–
PHONO	–	–	–

### Note

You may not be able to operate your Yamaha component even if a YAMAHA remote control code is preset as listed above. In this case, try setting another YAMAHA remote control code.

- 1 Press one of the input selector buttons (A) on the remote control to select the input area you want to set up.

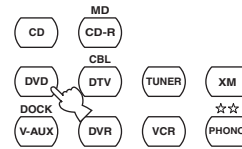

- 2 Press **CODE SET** using a ballpoint pen or a similar object.

The **TRANSMIT** indicator on the remote control flashes twice, and the selected input selector button lights up.

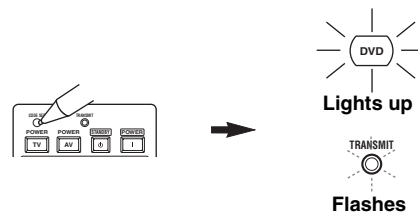

- 3 Press the numeric buttons (0 to 9) (B) to enter the five-digit remote control code for the component to be used.

The **TRANSMIT** indicator on the remote control flashes twice, and the remote control code for the selected component is set.

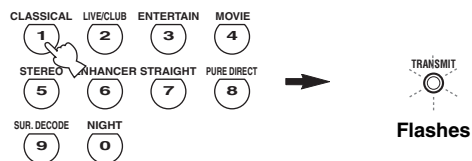

Refer to “List of remote control codes” at the end of this manual.

### Notes

- If the manufacturer of your component has more than one code, try each of them until you find the correct one.
- If you do not press any buttons within 30 seconds in step 3, the setup process is canceled. If this happens, repeat the setup procedure.
- If you enter the code number “9980”, the remote control code previously set for the selected input area is cleared.

## Resetting all remote control codes

Use this feature to clear all the remote control codes previously set and reset all of them to the initial factory settings.

### 1 Press **⓪** CODE SET using a ballpoint pen or a similar object.

The **⓪** TRANSMIT indicator on the remote control flashes twice.

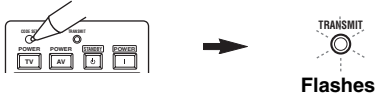

### 2 Press the numeric buttons (**Ⓢ**) to enter the code number "9981".

The **⓪** TRANSMIT indicator on the remote control flashes twice, and all the remote control codes previously set are cleared and reset to the initial factory settings.

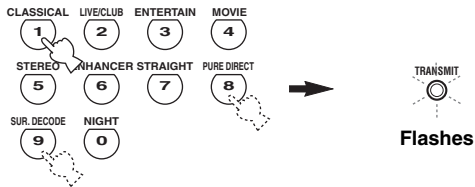

If you do not press any buttons within 30 seconds after step 2, the clearing process is canceled. In this case, repeat the clearing procedure.

# Using multi-zone configuration

This unit allows you to configure a multi-zone audio system. The Zone 2 feature allows you to set this unit to reproduce separate input sources in the main zone and the second zone (Zone 2). You can control this unit from the second zone using the supplied remote control.

Only analog signals are sent to the second zone. Any source you want to listen to in the second zone must be connected to the analog AUDIO IN jacks of this unit.

## Connecting Zone 2

You need the following additional equipment to use the multi-zone functions of this unit:

- An infrared signal receiver in the second zone.
- An infrared signal emitter in the main zone. This emitter transmits the infrared signals from the remote control via the infrared signal receiver in the second zone to a CD player or a DVD player, etc. in the main zone.
- An amplifier and speakers in the second zone.

- ☀ Since there are many possible ways to connect and use this unit in a multi-zone configuration, we recommend that you consult with your nearest authorized Yamaha dealer or service center about the Zone 2 connections that best meet your requirements.
- Some Yamaha models are able to connect directly to the REMOTE jacks of this unit. If you own these products, you may not need to use an infrared signal emitter. Up to 6 Yamaha components can be connected as shown below.

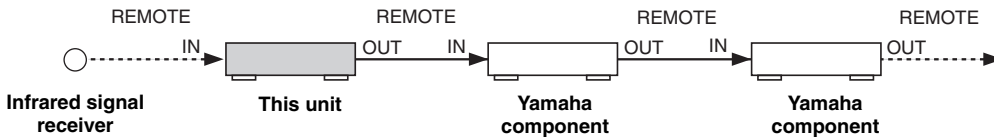

### ■ Using the external amplifier

Connect the amplifier/receiver in the second zone and other components to this unit as follows.

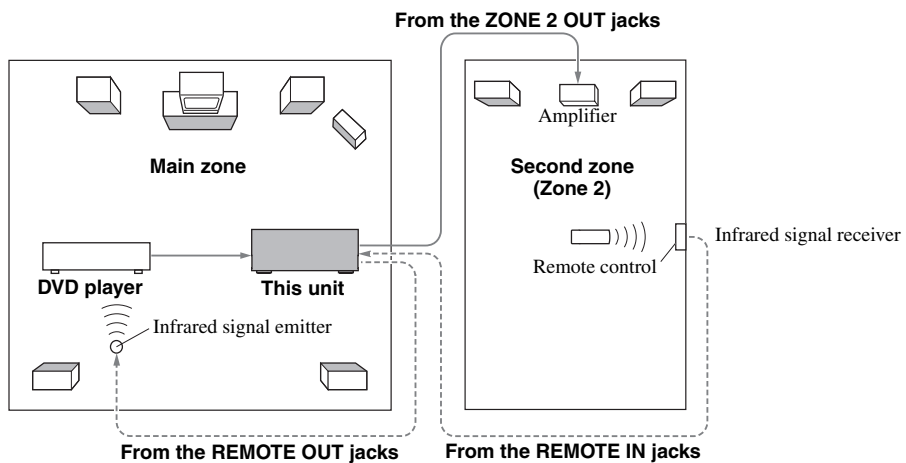

### Note

To avoid unexpected noise, DO NOT USE the Zone 2 feature with CDs encoded in DTS.

## ■ Using the internal amplifier of this unit

### Important safety notice

The EXTRA SP speaker terminals of this Receiver should not be connected to a Passive Loudspeaker Selector Box or more than one loudspeaker per channel.

Connection to a Passive Loudspeaker Selector Box or multiple speakers per channel could create an abnormally low impedance load resulting in amplifier damage. See this owner's manual for correct usage.

Compliance with minimum speaker impedance information for all channels must be maintained at all times. This information is found on the back panel of your Receiver.

Connect the speakers in the second zone to the EXTRA SP speaker terminals and then set the "EXTRA SP ASSIGN" to "ZONE2" (see page 72).

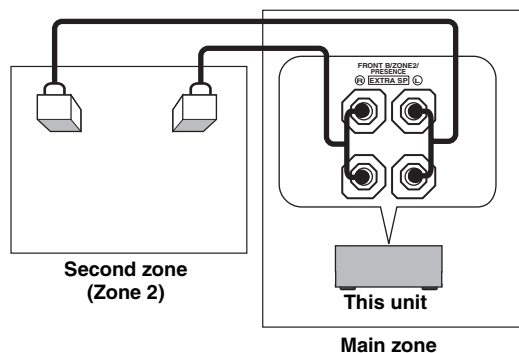

- You can use the FRONT B speakers as the front speaker system of another zone. Set "EXTRA SP ASSIGN" to "FRONT B" and then "FRONT B" to "ZONE B" (see page 72).
- When you use the internal amplifiers for the Zone 2 speakers, you can adjust the volume level and set the initial volume level and maximum volume level of the Zone 2 speakers (see page 82).

## Controlling Zone 2

You can select and control Zone 2 by using the control buttons on the front panel or on the remote control. The available operations are as follows:

- Selecting the input source of Zone 2
- Tuning into FM or AM when "TUNER" is selected as the input source of Zone 2 (see page 50)
- Tuning into XM Satellite Radio when "XM" is selected as the input source of Zone 2 (see page 53) (U.S.A. and Canada models only)
- Enjoying music stored on your iPod stationed in a Yamaha iPod universal dock (such as YDS-10 sold separately) connected to the DOCK terminal of this unit when "V-AUX" is selected as the input source (see page 58)

### Note

You must complete each step while the ZONE2 indicator is flashing in the front panel display. Otherwise, the Zone 2 mode is automatically canceled and this unit returns to the normal operation mode. In this case, repeat the Zone 2 selection procedure.

## ■ Controlling Zone 2 with the front panel

### Turning on Zone 2

Press **Ⓢ ZONE 2 ON/OFF** to turn on Zone 2.



**Ⓢ ZONE 2 ON/OFF** is operational only when **Ⓜ MASTER ON/OFF** on the front panel is pressed inward to the ON position. Once **Ⓜ MASTER ON/OFF** on the front panel is pressed inward to the ON position, you can also press **Ⓟ POWER** or **Ⓢ STANDBY** on the remote control to turn on the main zone and Zone 2 or set them to the standby mode.

### Activating the Zone 2 operation mode

Press **Ⓢ ZONE CONTROL** to control Zone 2.

The ZONE2 indicator flashes in the front panel display for approximately 10 seconds.



Operate the following operations after activating the Zone 2 operation mode.

## Operating Zone 2

Rotate the **INPUT** selector to select the desired input source while the **ZONE2** indicator is flashing in the front panel display.

- Select “TUNER” as the input source to use the TUNER features in Zone 2. For details about the TUNER operations, see “FM/AM tuning” on page 50.
- Select “XM” as the input source to use the XM Satellite Radio features in Zone 2. For details about the XM Satellite Radio operations, see “XM Satellite Radio tuning” on page 53.
- Select “V-AUX” as the input source to use iPod features in Zone 2. For details about the iPod operations, see “Using iPod™” on page 58.

## Set Zone 2 to the standby mode

Press **ZONE 2 ON/OFF** to set Zone 2 to the standby mode.

## Setting the remote control to the Zone 2 mode

The remote control is originally set to the main mode to control the main zone. To control Zone 2 with the remote control, you must first set the remote control to the Zone 2 mode.

### 1 Press **CODE SET** using a ballpoint pen or a similar object.

The **TRANSMIT** indicator on the remote control flashes twice.

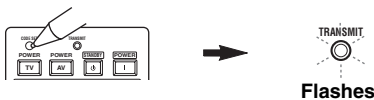

### 2 Press the numeric buttons (0-9) to enter the code number “9992”.

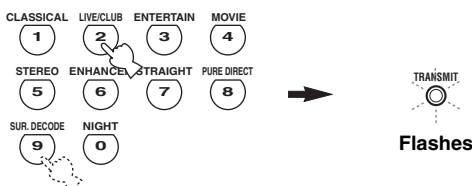

## Controlling Zone 2 with the remote control

### Turning on Zone 2

Press and hold **POWER** or **STANDBY** and then press **☆☆** to set the remote control to the Zone 2 mode.

- Press **POWER** when the main zone is turned on.
- Press **STANDBY** when the main zone is turned off.

The **TRANSMIT** indicator on the remote control lights up while the remote control is set to the Zone 2 mode.

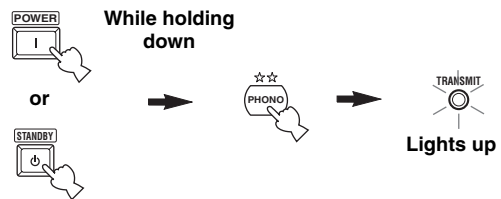

### Notes

- When the remote control is set to the Zone 2 mode, **POWER**, **STANDBY**, **VOLUME +/-**, **MUTE**, and the input selector buttons are set to control Zone 2. However, the rest of the remote control buttons remain in the main mode.
- The remote control automatically exits from the Zone 2 mode in the following cases:
  - when you do not make any operations within 10 seconds after the remote control is set to the Zone 2 mode.
  - when you press a remote control button other than **POWER**, **STANDBY**, **VOLUME +/-**, **MUTE**, and the input selector buttons.

### Activating the Zone 2 operation mode

Press **POWER** to turn on Zone 2.

### Operating Zone 2

Press one of the input selector buttons (A) to select the desired input source of Zone 2.

### Setting Zone 2 to the standby mode

Press **STANDBY** to set Zone 2 to the standby mode.

# Advanced setup

This unit has additional menus that are displayed in the front panel display. The advanced setup menu offers additional operations to adjust and customize the way this unit operates. Change the initial settings (indicated in bold under each parameter) to reflect the needs of your listening environment.

## Notes

- The settings you make are reflected next time you press **12** **MASTER ON/OFF** inward to the ON position to turn on this unit (see page 25).
- Only **12** **MASTER ON/OFF**, **13** **TONE CONTROL** and the **14** **PROGRAM** selector are effective while you are using the advanced setup menu.
- No other operations can be made while you are using the advanced setup menu.
- The advanced setup menu is only available in the front panel display.

## Using the advanced setup

**1** Press **12** **MASTER ON/OFF** on the front panel to release it outward to the OFF position to turn off this unit.

**2** Press and hold **13** **TONE CONTROL** and then press **12** **MASTER ON/OFF** inward to the ON position to turn on this unit.

This unit turns on, and the advanced setup menu appears in the front panel display.



**3** Rotate the **14** **PROGRAM** selector to select the parameter you want to adjust.

The name of the selected parameter appears in the front panel display.

See page 93 for a complete list of available parameters.

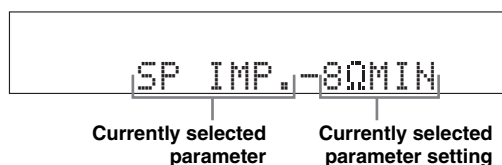

**4** Press **13** **TONE CONTROL** repeatedly to change the selected parameter setting.

**5** Press **12** **MASTER ON/OFF** to release it outward to the OFF position to save the new setting and turn off this unit.



The settings you made are reflected next time you turn on this unit.



See page 92 for the operation of the advanced setup.

**Speaker impedance SP IMP.**

Use this feature to set the speaker impedance of this unit so that it matches that of your speakers.

Choices: **8Ω MIN**, **6Ω MIN**

- Select “8Ω MIN” to set the speaker impedance to 8 Ω .
- Select “6Ω MIN” to set the speaker impedance to 6 Ω .

SP IMP.	Speaker	Impedance level
8Ω MIN	Front	If you use one set (A or B), the impedance of each speaker must be 8 Ω or higher.  If you use two sets (A and B), the impedance of each speaker must be 16 Ω or higher.*
	Center	
	Surround	The impedance of each speaker must be 8 Ω or higher.
	Surround back	
6Ω MIN	Front	If you use one set (A or B), the impedance of each speaker must be 4 Ω or higher.  If you use two sets (A and B), the impedance of each speaker must be 8 Ω or higher.
	Center	
	Surround	The impedance of each speaker must be 6 Ω or higher.
	Surround back	

\* The Canada model cannot use two separate speaker systems (A and B) simultaneously when “SP IMP.” is set to “8Ω MIN”.

**User presets PRESET**

Use this feature to reset all the parameters of this unit to the initial factory settings (see page 103).

Choices: **CANCEL**, **RESET**

- Select “CANCEL” not to reset any parameters of this unit.
- Select “RESET” to reset the parameters of this unit.

**Notes**

- This setting completely resets all the parameters of this unit including the “SET MENU” parameters.
- The initial factory settings are activated next time you turn on this unit.

**Remote control AMP ID REMOTE AMP**

Use this feature to set the AMP ID of this unit for remote control recognition. This feature is useful when you operate this unit and the other Yamaha receivers/ amplifiers in the same room separately.

Choices: **ID1**, **ID2**

- Select “ID1” when the remote control AMP ID code is set to “00001”.
- Select “ID2” when the remote control AMP ID code is set to “00002”.

**Setting remote control AMP ID codes**

You need to set the remote control AMP ID code for the remote control.

**1 Press  $\text{\textcircled{V}}$  CODE SET using a ballpoint pen or a similar object.**

The  $\text{\textcircled{V}}$  TRANSMIT indicator on the remote control flashes twice.

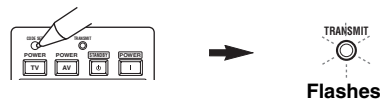

**2 Press the numeric buttons ( $\text{\textcircled{\#}}$ ) to enter the code number “00001” or “00002”.**

The  $\text{\textcircled{V}}$  TRANSMIT indicator on the remote control flashes twice, and the AMP ID code is changed.

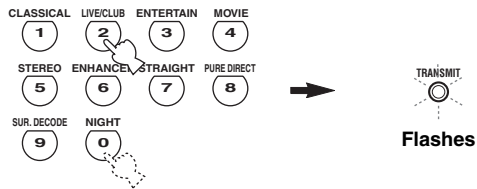

AMP ID code *1	Function	Remote control AMP ID *2
00001 (initial setting)	To operate this unit using the default code.	ID1 (initial setting)
00002	To operate this unit using an alternative code.	ID2

\*1 The remote control setting

\*2 The setting of this unit

See page 92 for the operation of the advanced setup.

### Remote control TUNER ID REMOTE TUN

Use this feature to set the TUNER ID of this unit for remote control recognition.

Choices: ID1, ID2

- Select "ID1" when the remote control TUNER ID code is set to "82005".
- Select "ID2" when the remote control TUNER ID code is set to "81949".

#### Setting remote control TUNER ID codes

You need to set the remote control TUNER ID library code for the remote control.

- 1 Press **(A) TUNER** to select "TUNER" as the input source.



- 2 Press **(U) CODE SET** using a ballpoint pen or a similar object.

The **(V) TRANSMIT** indicator on the remote control flashes twice.

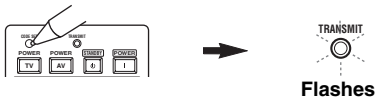

- 3 Press the numeric buttons **(B)** to enter the code number "82005" or "81949".

The **(V) TRANSMIT** indicator on the remote control flashes twice, and the TUNER ID code is changed.

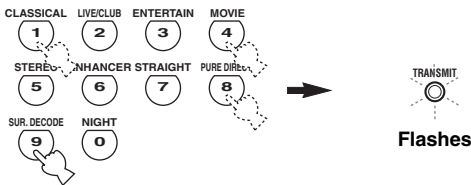

TUNER ID code *1	Function	Remote control TUNER ID *2
82005 (initial setting)	To operate this unit using the default code.	ID1 (initial setting)
81949	To operate this unit using an alternative code.	ID2

\*1 The remote control setting

\*2 The setting of this unit

### Remote control XM ID REMOTE XM (U.S.A. and Canada models only)

Use this feature to set the XM ID of this unit for remote control recognition.

Choices: ID1, ID2

- Select "ID1" when the remote control XM ID code is set to "82006".
- Select "ID2" when the remote control XM ID code is set to "82007".

#### Setting remote control XM ID codes

You need to set the remote control XM ID code for the remote control.

- 1 Press **(A) XM** to select "XM" as the input source.



- 2 Press **(U) CODE SET** using a ballpoint pen or a similar object.

The **(V) TRANSMIT** indicator on the remote control flashes twice.

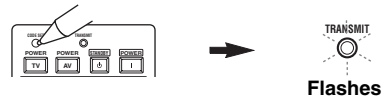

- 3 Press the numeric buttons **(B)** to enter the code number "82006" or "82007".

The **(V) TRANSMIT** indicator on the remote control flashes twice, and the XM ID code is changed.

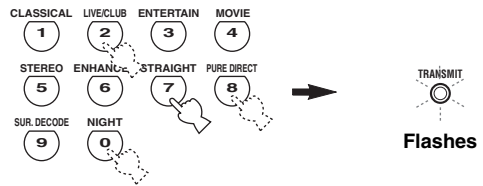

XM ID code *1	Function	Remote control XM ID *2
82006 (initial setting)	To operate this unit using the default code.	ID1 (initial setting)
82007	To operate this unit using an alternative code.	ID2

\*1 The remote control setting

\*2 The setting of this unit

See page 92 for the operation of the advanced setup.

### ■ SCENE IR code setting SCENE IR

Use this feature to output the remote control signals at the REMOTE OUT jack automatically when this unit is in the SCENE mode.

Choices: **ON**, OFF

- Select “ON” when the component connected to the REMOTE OUT jack is the Yamaha component and has the capability of the SCENE control signals. This unit automatically sends the remote control signals to the component.
- Select “OFF” when the component connected to the REMOTE OUT jack is not the Yamaha component and does not have the capability of the SCENE control signals.

#### Note

If noises are output when you operate the SCENE function, set “SCENE IR” to “OFF”.

### ■ Bi-amplifier setting BI-AMP

Use this feature to activate or deactivate the bi-amplifier function (see page 14).

Choices: ON, **OFF**

- Select “ON” if you want to activate the bi-amplifier function. “SUR. B L/R SP” is set to NONE” automatically, and this unit outputs the front channel audio signals at the SURROUND BACK speaker terminals.
- Select “OFF” if you want to deactivate the bi-amplifier function.

#### Note

When “BI-AMP” is set to “ON”, you can only select “FRONT B” or “NONE” in “EXTRA SP ASSIGN” (see page 72).

### ■ Tuner frequency step TU (Asia and General models only)

Use this feature to set the tuner frequency step according to the frequency spacing in your area.

Choices: **AM10/FM100**, AM9/FM50

- Select “AM10/FM100” for North, Central and South America.
- Select “AM9/FM50” for all other areas.

# Troubleshooting

Refer to the table below when this unit does not function properly. If the problem you are experiencing is not listed below or if the instruction below does not help, turn off this unit, disconnect the power cable, and contact the nearest authorized Yamaha dealer or service center.

## ■ General

Problem	Cause	Remedy	See page
<b>This unit fails to turn on or enters the standby mode soon after the power is turned on.</b>	The power cable is not connected or the plug is not completely inserted.	Connect the power cable firmly.	—
	The speaker impedance setting is incorrect.	Set the speaker impedance to match your speakers.	25
	The protection circuitry has been activated.	Make sure that all speaker wire connections on this unit and on all speakers are secure and that the wires for each connection do not touch anything other than their respective connections.	13
	This unit has been exposed to a strong external electric shock (such as lightning or strong static electricity).	Set this unit to the standby mode, disconnect the power cable, plug it back in after 30 seconds and then use this unit normally.	—
<b>No sound.</b>	Incorrect input or output cable connections.	Connect the cables properly. If the problem persists, the cables may be defective.	18-23
	The optimizer microphone is connected.	Disconnect the optimizer microphone.	31
	Audio input jack select is set to “HDMI”, “COAX/OPT” or “ANALOG”.	Set Audio input jack select to “AUTO”.	39
	Audio input jack select is set to “ANALOG” while playing a source encoded in Dolby Digital or DTS.	Set Audio input jack select to “AUTO” or “COAX/OPT”.	39
	No appropriate input source has been selected.	Select an appropriate input source with the INPUT selector on the front panel (or the input selector buttons on the remote control).	37, 38
	Speaker connections are not secure.	Secure the connections.	13
	The front speakers to be used have not been selected properly.	Select the front speakers by pressing <b>ⓈPEAKERS</b> on the front panel repeatedly.	38
	The volume is turned down.	Turn up the volume.	—
	The sound is muted.	Press <b>ⓂMUTE</b> or <b>ⓊVOLUME +/-</b> on the remote control to resume audio output and then adjust the volume.	40
	Signals this unit cannot reproduce are being input from a source component, such as a CD-ROM.	Play a source whose signals can be reproduced by this unit.	—
	The HDMI components connected to this unit do not support the HDCP copy protection standards.	Connect HDMI components that support the HDCP copy protection standards.	16
	“SUPPORT AUDIO” is set to “OTHER” and “HDMI” audio signals are not being played back on this unit.	Set “SUPPORT AUDIO” to “RX-V661” in “MANUAL SETUP”.	77
<b>No picture.</b>	The output and input for the picture are connected to different types of video jacks.	Set “V CONV.” to “ON” or connect your source components in the same way as you connect your video monitor to this unit.	81
	Non-standard video signals are input.		

Problem	Cause	Remedy	See page
<b>The sound suddenly goes off.</b>	The protection circuitry has been activated because of a short circuit, etc.	Check that the speaker impedance setting is correct.	25, 93
		Check that the speaker wires are not touching each other and then turn this unit back on.	—
	The sleep timer has turned this unit off.	Turn this unit on, and play the source again.	—
	The sound is muted.	Press <b>MUTE</b> or <b>VOLUME +/-</b> on the remote control to resume audio output.	40
<b>Sound is heard from the speaker on one side only.</b>	Incorrect cable connections.	Connect the cables properly. If the problem persists, the cables may be defective.	13
	Incorrect settings in “SPEAKER LEVEL”.	Adjust the “SPEAKER LEVEL” settings.	74
<b>Only the center speaker outputs substantial sound.</b>	When playing a monaural source with a CINEMA DSP program, the source signal is directed to the center channel, and the front and surround speakers output effect sounds.		
<b>No sound is heard from the center speaker.</b>	“CENTER SP” in “SET MENU” is set to “NONE”.	Set “CENTER SP” to “SML” or “LRG”.	73
	One of the HiFi DSP programs (except for “7ch Stereo”) has been selected.	Try another sound field program.	42
<b>No sound from the presence speakers.</b>	The sound field programs are turned off.	Press <b>STRAIGHT</b> to turn them on.	47
	You are using a source or program combination that does not output sound from all channels.	Try another sound field program.	37
	“EXTRA SP ASSIGN” is set to a setting other than “PRESENCE”.	Set “EXTRA SP ASSIGN” to “PRESENCE”.	72
<b>No sound is heard from the surround speakers.</b>	“SUR. L/R SP” in “SET MENU” is set to “NONE”.	Set “SUR. L/R SP” to “SML” or “LRG”.	73
	This unit is in the “STRAIGHT” mode and a monaural source is being played back.	Press <b>STRAIGHT</b> on the front panel so that “STRAIGHT” disappears from the front panel display.	47
<b>No sound is heard from the surround back speakers.</b>	“SUR. L/R SP” in “SET MENU” is set to “NONE” and “SB L/R SP” is automatically set to “NONE”.	Set “SUR. L/R SP” and “SB L/R SP” to a setting other than “NONE”.	73
	“SUR. B L/R SP” in “SET MENU” is set to “NONE”.	Set “SUR. B L/R SP” to a setting other than “NONE”.	73
<b>Zone 2 speaker settings are not available in “SET MENU”.</b>	“EXTRA SP ASSIGN” is set to a setting other than “ZONE2”.	Set “EXTRA SP ASSIGN” to “ZONE2”.	72
<b>FRONT B speakers cannot be activated.</b>	“EXTRA SP ASSIGN” is set to a setting other than “FRONT B”.	Set “EXTRA SP ASSIGN” to “FRONT B”.	72
<b>No sound from the center, surround or surround back speakers when the FRONT B speakers are activated.</b>	“FRONT B” in “SPEAKER SET” is set to “ZONE B”.	Set “FRONT B” to “FRONT”.	72
<b>Presence speaker settings are not available in “SET MENU”.</b>	“EXTRA SP ASSIGN” is set to a setting other than “PRESENCE”.	Set “EXTRA SP ASSIGN” to “PRESENCE”.	72

Problem	Cause	Remedy	See page
<b>No sound is heard from the subwoofer.</b>	“LFE/BASS OUT” in “SET MENU” is set to “FRONT” when a Dolby Digital or DTS signal is being played.	Set “LFE/BASS OUT” to “SWFR” or “BOTH”.	72
	“LFE/BASS OUT” in “SET MENU” is set to “SWFR” or “FRONT” when a 2-channel source is being played.	Set “LFE/BASS OUT” to “BOTH”.	72
	The source does not contain low-frequency signals.		
<b>Dolby Digital or DTS sources cannot be played. (Dolby Digital or DTS indicator in the front panel display does not light up.)</b>	The connected component is not set to output Dolby Digital or DTS digital signals.	Make an appropriate setting following the operating instructions for your component.	—
	Audio input jack select is set to “ANALOG”.	Set Audio input jack select to “AUTO”.	39
<b>A humming sound is heard.</b>	Incorrect cable connections.	Connect the audio cables firmly. If the problem persists, the cables may be defective.	—
	No connection from the turntable to the GND terminal.	Connect the grounding cable of your turntable to the GND terminal of this unit.	21
<b>The volume level is low while a record is being played.</b>	The record is being played on a turntable with an MC cartridge.	Connect your turntable to this unit through an MC-head amplifier.	21
<b>The volume level cannot be increased, or the sound is distorted.</b>	The component connected to the AUDIO OUT (REC) jacks of this unit is turned off.	Turn on the power of the component.	—
<b>The sound effects cannot be recorded.</b>	It is not possible to record the sound effects with a recording component.		
<b>A source cannot be recorded by a digital recording component connected to the DIGITAL OUTPUT jack.</b>	The source component is not connected to the DIGITAL INPUT jacks of this unit.	Connect the source component to the DIGITAL INPUT jacks.	19, 21
	Some components cannot record Dolby Digital or DTS sources.		
<b>A source cannot be recorded by an analog component connected to the AUDIO OUT (REC) jacks.</b>	The source component is not connected to the analog AUDIO IN jacks of this unit.	Connect the source component to the analog AUDIO IN jacks.	21
<b>The sound field parameters and some other settings of this unit cannot be changed.</b>	“MEMORY GUARD” in “SET MENU” is set to “ON”.	Set “MEMORY GUARD” to “OFF”.	82
<b>This unit does not operate properly.</b>	The internal microcomputer has been frozen by an external electric shock (such as lightning or excessive static electricity) or by a power supply with low voltage.	Disconnect the power cable from the AC wall outlet and then plug it in again after about 30 seconds.	—
<b>No sound is heard from the connected HDMI component.</b>	The HDMI component does not accept the multi-channel audio signals.	Convert the multi-channel audio signals to the 2-channel audio signals at the source component such as a DVD player.	—

Problem	Cause	Remedy	See page
<b>“CHECK SP WIRES” appears in the front panel display.</b>	Speaker cables are short-circuited.	Make sure all speaker cables are connected correctly.	13
<b>There is noise interference from digital or radio frequency equipment.</b>	This unit is too close to the digital or high-frequency equipment.	Move this unit further away from such equipment.	—
<b>The picture is disturbed.</b>	The video source uses scrambled or encoded signals to prevent dubbing.		
<b>This unit suddenly enters the standby mode.</b>	The internal temperature is too high and the overheat protection circuitry has been activated.	Wait about 1 hour for this unit to cool down and then turn it back on.	—

■ Tuner

Problem	Cause	Remedy	See page		
<b>FM</b>	<b>FM stereo reception is noisy.</b>	The characteristics of FM stereo broadcasts may cause this problem when the transmitter is too far away or the antenna input is poor.	Check the antenna connections. — Try using a high-quality directional FM antenna. — Use the manual tuning method.	24 — 50	
		<b>There is distortion, and clear reception cannot be obtained even with a good FM antenna.</b>	There is multi-path interference.	Adjust the antenna position to eliminate multi-path interference.	—
		<b>The desired station cannot be tuned into with the automatic tuning method.</b>	The signal is too weak.	Use a high-quality directional FM antenna. — Use the manual tuning method.	— 50
	<b>Previously preset stations can no longer be tuned into.</b>	This unit has been disconnected for a long period.	Preset the stations again.	51	
<b>AM</b>	<b>The desired station cannot be tuned into with the automatic tuning method.</b>	The signal is weak or the antenna connections are loose.	Tighten the AM loop antenna connections and orient the antenna for the best reception. — Use the manual tuning method.	— 50	
	<b>There are continuous crackling and hissing noises.</b>	Noise can result from lightning, fluorescent lamps, motors, thermostats and other electrical equipment.	Use an outdoor antenna and a ground wire. This will help somewhat, but it is difficult to eliminate all noise.	—	
	<b>There are buzzing and whining noises.</b>	A TV set is being used nearby.	Move this unit away from the TV set.	—	

## ■ XM Satellite Radio

If an operation takes longer than usual or an error occurs, one of the following messages may appear in the front panel display. In this case, read the cause and follow the corresponding remedies.

Status message	Cause	Remedy	See page
CHECK ANTENNA	The XM Mini-Tuner and XM Dock are not connected to the XM jack of this unit or do not work properly.	Check XM Mini-Tuner and XM Dock connections and orient for the best reception level.	53
UPDATING	The XM user encryption code is being updated.	Wait until the encryption code is updated.	—
NO SIGNAL	The signal is too weak.	Adjust the orientation of the XM Mini-Tuner for the best reception level.	53
LOADING	It takes longer than four seconds for audio or text data to be decoded.	Wait until the decoding process has finished.	—
OFF AIR	The XM Satellite Radio channel you selected is not currently broadcasting any signals.	Check the channel number again or select another XM Satellite Radio channel.	—
<XM> - - -	The Channel Station ID (SID) is no longer available.		
- - - / - - -	No artist name or song title is available.		
<CAT> - - -	No channels are available for the selected category.	Select another channel category by pressing <b>④CATEGORY</b> on the front panel (or <b>ⓂA-E/CAT.</b> < /> on the remote control) repeatedly.	55

## ■ Remote control

Problem	Cause	Remedy	See page
<b>The remote control does not work or function properly.</b>	Wrong distance or angle.	The remote control will function within a maximum range of 6 m (20 ft) and no more than 30 degrees off-axis from the front panel.	27
	Direct sunlight or lighting (from an inverter type of fluorescent lamp, etc.) is striking the remote control sensor of this unit.	Reposition this unit.	—
	The batteries are weak.	Replace all batteries.	—
	The operation mode selector is set incorrectly.	Set the operation mode selector correctly. When operating this unit, set it to the <b>ⓂAMP</b> position. When operating the component selected by the input selector button, set it to the <b>ⓂSOURCE</b> position. When operating the TV set in the DTV or PHONO area, set it to the <b>ⓂTV</b> position.	—
	The remote control code was not correctly set.	Set the remote control code correctly using “List of remote control codes” at the end of this manual.	87
		Try setting another code of the same manufacturer using “List of remote control codes” at the end of this manual.	87
	The ID code of the remote control and the remote control ID of this unit do not match.	Match the remote control ID of this unit with the corresponding remote control ID code.	93



## ■ HDMI

Error message	Cause	Remedy	See page
DEVICE OVER	The number of the connected HDMI components is over the limit.	Reduce the number of the connected HDMI components.	—
HDCP ERROR	HDCP authentication failed.	Check that the connected HDMI components support the HDCP copy protection standards.	—

## ■ iPod

### Note

In case of a transmission error without a status message appearing in the front panel and in the OSD, check the connection to your iPod (see page 23).

Status message	Cause	Remedy	See page
Loading...	This unit is in the middle of recognizing the connection with your iPod. This unit is in the middle of acquiring song lists from your iPod.		
Connect error	There is a problem with the signal path from your iPod to this unit.	Turn off this unit and reconnect the Yamaha iPod universal dock to the DOCK terminal of this unit. Try resetting your iPod.	23 —
Unknown iPod	The iPod being used is not supported by this unit.	Only iPod (Click and Wheel), iPod nano, and iPod mini are supported.	—
iPod connected	Your iPod is properly stationed in a Yamaha iPod universal dock (such as the YDS-10, sold separately) connected to the DOCK terminal of this unit, and the connection between your iPod and this unit is complete.		
Disconnected	Your iPod was removed from a Yamaha iPod universal dock (such as YDS-10 sold separately) connected to the DOCK terminal of this unit.	Station your iPod back in a Yamaha iPod universal dock (such as YDS-10 sold separately) connected to the DOCK terminal of this unit.	23
Unable to Play	This unit cannot play back the songs currently stored on your iPod.	Check that the songs currently stored on your iPod are playable. Store some other playable music files on your iPod.	— —

## ■ AUTO SETUP

### Before AUTO SETUP

Error message	Cause	Remedy	See page
Connect MIC!	Optimizer microphone is not connected.	Connect the supplied optimizer microphone to the OPTIMIZER MIC jack on the front panel.	28
Unplug HP!	Headphones are connected.	Unplug the headphones.	—

**During AUTO SETUP**

Error message	Cause	Remedy	See page
E-1:NO FRONT SP	Front L/R channel signals are not detected.	Check the front L/R speaker connections.	13
E-2:NO SUR SP	A surround channel signal is not detected.	Check the surround speaker connections.	13
E-3:NO PRNS SP	A presence channel signal is not detected.	Check the presence speaker connections.	13
E-4:SBR->SBL	Only a right surround back channel signal is detected.	Connect the surround back speaker to the LEFT SURROUND BACK SPEAKERS terminal if you only have one surround back speaker.	13
E-5:NOISY	Background noise is too loud.	Try running "AUTO SETUP" in a quiet environment.	—
		Turn off noisy electric equipment like air conditioners or move them away from the optimizer microphone.	—
E-6:CHECK SUR.	Surround back speakers are connected, though surround L/R speakers are not.	Connect surround speakers when you use surround back speakers.	13
E-7:NO MIC	The optimizer microphone was unplugged during the "AUTO SETUP" procedure.	Connect the supplied optimizer microphone to the OPTIMIZER MIC jack on the front panel.	28
E-8:NO SIGNAL	The optimizer microphone does not detect test tones.	Check the microphone setting.	28
		Check the speaker connections and placement.	13
E-9:USER CANCEL	The "AUTO SETUP" procedure was cancelled due to user activity.	Run "AUTO SETUP" again.	28
E-10:INTERNAL ERROR	An internal error occurred.	Run "AUTO SETUP" again.	28

**After AUTO SETUP**

Warning message	Cause	Remedy	See page
W-1:OUT OF PHASE	Speaker polarity is not correct. This message may appear depending on the speakers even when the speakers are connected correctly.	Check the speaker connections for proper polarity (+ or -).	13
W-2:OVER 24m (80ft)	The distance between the speaker and the listening position is over 24 m (80 ft).	Bring the speaker closer to the listening position.	—
W-3:LEVEL ERROR	The difference of volume level among speakers is excessive.	Readjust the speaker installation so that all speakers are set in locations with similar conditions.	—
		Check the speaker connections.	13
		Use speakers of similar quality.	—
W-4:CHECK PRNS	"EXTRA SP ASSIGN" is set to "PRESENCE", though the presence channel signals are not detected.	Adjust the output volume of the subwoofer.	28
		Check the presence speaker connections.	13
		Set "EXTRA SP ASSIGN" to a setting other than "PRESENCE".	72

**Notes**

- If the "ERROR" or "WARNING" screens appears, check the cause of the problem, then run "AUTO SETUP" again.
- If a warning message "W-1" appears, corrections are made, but they may not be optimal.
- If a warning message "W-2" or "W-3" appears, no corrections are made.
- If an error message "E-10" occurs repeatedly, contact a qualified Yamaha service center.

# Resetting the system

Use this feature to reset all the parameters of this unit to the initial factory settings.

## Notes

- This procedure completely resets all the parameters of this unit including the “SET MENU” parameters. However, the advanced setup menu parameters will not be initialized.
- The initial factory settings are activated next time you turn on this unit.



To cancel the initialization procedure at any time without making any changes, press **12 MASTER ON/OFF** on the front panel to release it outward to the OFF position.

---

**1 Press 12 MASTER ON/OFF on the front panel to release it outward to the OFF position to turn off this unit.**

---

**2 Press and hold 13 TONE CONTROL and then press 12 MASTER ON/OFF inward to the ON position to turn on this unit.**

This unit turns on, and the advanced setup menu appears in the front panel display.



---

**3 Rotate the 14 PROGRAM selector to select “PRESET”.**

---

**4 Press 13 TONE CONTROL repeatedly to select “RESET”.**



Select “CANCEL” to cancel the initialization procedure without making any changes.

---

**5 Press 12 MASTER ON/OFF to release it outward to the OFF position to confirm your selection and turn off this unit.**

# Glossary

## ■ Bi-amplification connection

A bi-amplification connection uses two amplifiers for a speaker. One amplifier is connected to the woofer section of a loudspeaker while the other is connected to the combined mid and tweeter section. With this arrangement each amplifier operates over a restricted frequency range. This restricted range presents each amplifier with a much simpler job and each amplifier is less likely to influence the sound in some way. The internal crossover of the speaker consists of a LPF (low pass filter) and a HPF (high pass filter). As its name implies, the LPF passes frequencies below a cutoff and rejects frequencies above the cutoff frequency. Likewise, the HPF passes frequencies above its cutoff.

## ■ Component video signal

With the component video signal system, the video signal is separated into the Y signal for the luminance and the P<sub>b</sub> and P<sub>r</sub> signals for the chrominance. Color can be reproduced more faithfully with this system because each of these signals is independent. The component signal is also called the “color difference signal” because the luminance signal is subtracted from the color signal. A monitor with component input jacks is required in order to output component signals.

## ■ Composite video signal

With the composite video signal system, the video signal is composed of three basic elements of a video picture: color, brightness and synchronization data. A composite video jack on a video component transmits these three elements combined.

## ■ Dolby Digital

Dolby Digital is a digital surround sound system that gives you completely independent multi-channel audio. With 3 front channels (front L/R and center), and 2 surround stereo channels, Dolby Digital provides 5 full-range audio channels. With an additional channel especially for bass effects, called LFE (Low Frequency Effect), the system has a total of 5.1-channels (LFE is counted as 0.1 channel). By using 2-channel stereo for the surround speakers, more accurate moving sound effects and surround sound environment are possible than with Dolby Surround. The wide dynamic range from maximum to minimum volume reproduced by the 5 full-range channels and the precise sound orientation generated using digital sound processing provide listeners with unprecedented excitement and realism. With this unit, any sound environment from monaural up to a 5.1-channel configuration can be freely selected for your enjoyment.

## ■ Dolby Digital EX

Dolby Digital EX creates 6 full-bandwidth output channels from 5.1-channel sources. This is done using a matrix decoder that derives 3 surround channels from the 2 in the original recording. For the best results, Dolby Digital EX should be used with movie sound tracks recorded with Dolby Digital Surround EX. With this additional channel, you can experience more dynamic and realistic moving sound especially with scenes with “fly-over” and “fly-around” effects.

## ■ Dolby Pro Logic II

Dolby Pro Logic II is an improved technique used to decode vast numbers of existing Dolby Surround sources. This new technology enables a discrete 5-channel playback with 2 front left and right channels, 1 center channel, and 2 surround left and right channels instead of only 1 surround channel for conventional Pro Logic technology. There are three modes available: “Music mode” for music sources, “Movie mode” for movie sources and “Game mode” for game sources.

## ■ Dolby Pro Logic IIx

Dolby Pro Logic IIx is a new technology enabling discrete multi-channel playback from 2-channel or multi-channel sources. There are three modes available: “Music mode” for music sources, “Movie mode” for movie sources (for 2-channel sources only) and “Game mode” for game sources.

## ■ Dolby Surround

Dolby Surround uses a 4-channel analog recording system to reproduce realistic and dynamic sound effects: 2 front left and right channels (stereo), a center channel for dialog (monaural), and a surround channel for special sound effects (monaural). The surround channel reproduces sound within a narrow frequency range. Dolby Surround is widely used with nearly all video tapes and laser discs, and in many TV and cable broadcasts as well. The Dolby Pro Logic decoder built into this unit employs a digital signal processing system that automatically stabilizes the volume on each channel to enhance moving sound effects and directionality.

## ■ DSD

Direct Stream Digital (DSD) technology stores audio signals on digital storage media, such as Super Audio CDs. Using DSD, signals are stored as single bit values at a high-frequency sampling rate of 2.8224 MHz, while noise shaping and oversampling are used to reduce distortion, a common occurrence with very high quantization of audio signals. Due to the high sampling rate, better audio quality can be achieved than that offered by the PCM format used for normal audio CDs.

### ■ DTS 96/24

DTS 96/24 offers an unprecedented level of audio quality for multi-channel sound on DVD video, and is fully backward-compatible with all DTS decoders. “96” refers to a 96 kHz sampling rate compared to the typical 48 kHz sampling rate. “24” refers to 24-bit word length. DTS 96/24 offers sound quality transparent to the original 96/24 master, and 96/24 5.1-channel sound with full-quality full-motion video for music programs and motion picture soundtracks on DVD video.

### ■ DTS (Digital Theater Systems) Digital Surround

DTS digital surround was developed to replace the analog soundtracks of movies with a 6.1-channel digital sound track, and is now rapidly gaining popularity in movie theaters around the world. Digital Theater Systems Inc. has developed a home theater system so that you can enjoy the depth of sound and natural spatial representation of DTS digital surround in your home. This system produces practically distortion-free 6.1-channel sound (technically, front left and right, center, surround left and right, and LFE 0.1 (subwoofer) channels for a total of 5.1 channels). This unit incorporates a DTS-ES decoder that enables 6.1-channel reproduction by adding the surround back channel to the existing 5.1-channel format.

### ■ HDMI

HDMI (High-Definition Multimedia Interface) is the first industry-supported, uncompressed, all-digital audio/video interface. Providing an interface between any source (such as a set-top box or AV receiver) and an audio/video monitor (such as a digital television), HDMI supports standard, enhanced or high-definition video as well as multi-channel digital audio using a single cable. HDMI transmits all ATSC HDTV standards and supports 8-channel digital audio, with bandwidth to spare to accommodate future enhancements and requirements. When used in combination with HDCP (High-bandwidth Digital Content Protection), HDMI provides a secure audio/video interface that meets the security requirements of content providers and system operators. For further information on HDMI, visit the HDMI website at “<http://www.hdmi.org/>”.

### ■ LFE 0.1 channel

This channel reproduces low-frequency signals. The frequency range of this channel is from 20 Hz to 120 Hz. This channel is counted as 0.1 because it only enforces a low-frequency range compared to the full-range reproduced by the other 5/6 channels in Dolby Digital or DTS 5.1/6.1-channel systems.

### ■ Neo:6

Neo:6 decodes the conventional 2-channel sources for 6-channel playback by the specific decoder. It enables playback with the full-range channels with higher separation just like digital discrete signal playback. There are two modes available: “Music mode” for music sources and “Cinema mode” for movie sources.

### ■ Neural Surround

Neural Surround™ represents the latest advancement in surround technology and has been adopted by XM Satellite Radio for digital radio broadcast of surround recordings and live events in surround sound. Neural Surround™ employs psychoacoustic frequency domain processing which allows delivery of a more detailed sound stage with superior channel separation and localization of audio elements. System playback is scalable from 5.1 to 7.1 multi-channel surround playback.

### ■ PCM (Linear PCM)

Linear PCM is a signal format under which an analog audio signal is digitized, recorded and transmitted without using any compression. This is used as a method of recording CDs and DVD audio. The PCM system uses a technique for sampling the size of the analog signal per very small unit of time. Standing for “Pulse Code Modulation”, the analog signal is encoded as pulses and then modulated for recording.

### ■ Sampling frequency and number of quantized bits

When digitizing an analog audio signal, the number of times the signal is sampled per second is called the sampling frequency, while the degree of fineness when converting the sound level into a numeric value is called the number of quantized bits. The range of rates that can be played back is determined based on the sampling rate, while the dynamic range representing the sound level difference is determined by the number of quantized bits. In principle, the higher the sampling frequency, the wider the range of frequencies that can be played back, and the higher the number of quantized bits, the more finely the sound level can be reproduced.

### ■ S-video signal

With the S-video signal system, the video signal normally transmitted using a pin cable is separated and transmitted as the Y signal for the luminance and the C signal for the chrominance through the S-video cable. Using the S VIDEO jack eliminates video signal transmission loss and allows recording and playback of even more beautiful images.

# Sound field program information

## ■ Elements of a sound field

What really creates the rich, full tones of a live instrument are the multiple reflections from the walls of the room. In addition to making the sound live, these reflections enable us to tell where the player is situated as well as the size and shape of the room in which we are sitting.

There are two distinct types of sound reflections that combine to make up the sound field in addition to the direct sound coming straight to our ears from the player's instrument.

### Early reflections

Reflected sounds reach our ears extremely rapidly (50 ms to 100 ms after the direct sound), after reflecting from one surface only (for example, from a wall or the ceiling).

Early reflections actually add clarity to the direct sound.

### Reverberations

These are caused by reflections from more than one surface (for example, from the walls, and the ceiling) so numerous that they merge together to form a continuous sonic afterglow. They are non-directional and lessen the clarity of the direct sound.

Direct sound, early reflections and subsequent reverberations taken together help us to determine the subjective size and shape of the room, and it is this information that the digital sound field processor reproduces in order to create sound fields.

If you could create the appropriate early reflections and subsequent reverberations in your listening room, you would be able to create your own listening environment. The acoustics in your room could be changed to those of a concert hall, a dance floor, or a room with virtually any size at all. This ability to create sound fields at will is exactly what Yamaha has done with the digital sound field processor.

## ■ CINEMA DSP

Since the Dolby Surround and DTS systems were originally designed for use in movie theaters, their effect is best felt in a theater having many speakers designed for acoustic effects. Since home conditions, such as room size, wall material, number of speakers, and so on, can differ so widely, it is inevitable that there are differences in the sound heard. Based on a wealth of actually measured data, Yamaha CINEMA DSP uses Yamaha original sound field technology to combine Dolby Pro Logic, Dolby Digital and DTS systems to provide the audiovisual experience of a movie theater in the listening room of your own home.

## ■ SILENT CINEMA

Yamaha has developed a natural, realistic sound effect DSP algorithm for headphones. Parameters for headphones have been set for each sound field so that accurate representations of all the sound field programs can be enjoyed on headphones.

## ■ Virtual CINEMA DSP

Yamaha has developed a Virtual CINEMA DSP algorithm that allows you to enjoy DSP sound field surround effects even without any surround speakers by using virtual surround speakers. It is even possible to enjoy Virtual CINEMA DSP using a minimal two-speaker system that does not include a center speaker.

# Parametric equalizer information

This unit employs Yamaha Parametric Room Acoustic Optimizer (YPAO) technology, together with the Parametric EQ settings (see page 75), to optimize the frequency characteristics of its parametric equalizer to match your listening environment. YPAO uses a combination of the following three parameters (Frequency, Gain and Q factor) to provide highly precise adjustment of the frequency characteristics.

## ■ Frequency

This parameter is adjustable in one-third octave increments between 32 Hz and 16 kHz.

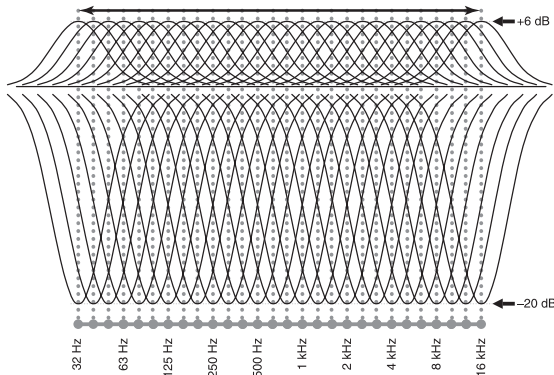

## ■ Gain

This parameter is adjustable in increments of 0.5 dB between -20 and +6 dB.

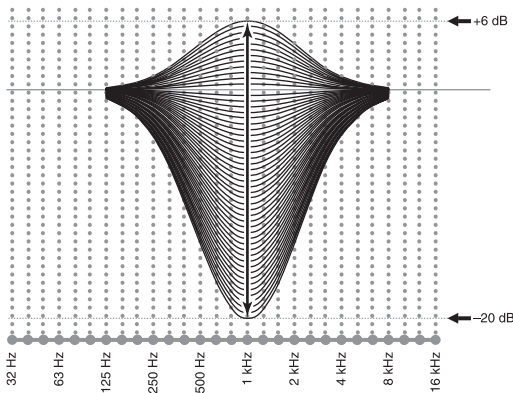

## ■ Q factor

The width of the specified frequency band is referred to as the Q factor. This parameter is adjustable between the values 0.5 and 10.

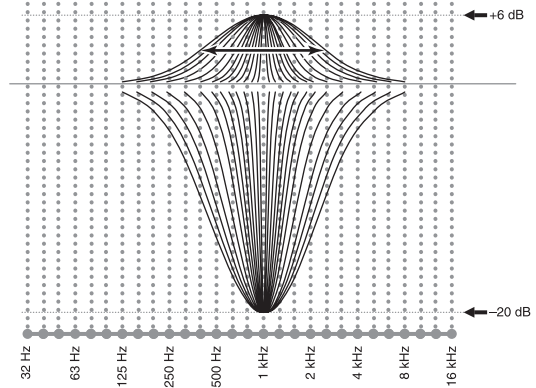

YPAO adjusts frequency characteristics to suit your listening requirements using a combination of the above three parameters (Frequency, Gain and Q factor) for each equalizer band in this unit's parametric equalizer. This unit has 7 equalizer bands for each channel.

The use of multiple equalizer bands enables more precise adjustments of frequency characteristics (as in Figure 2). This is not possible using only a single equalizer band (as in Figure 1).

Figure 1

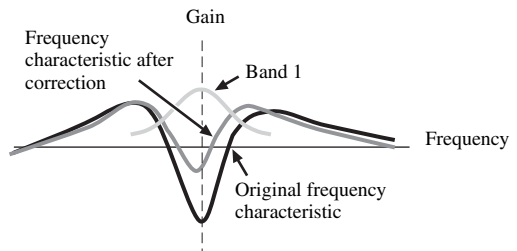
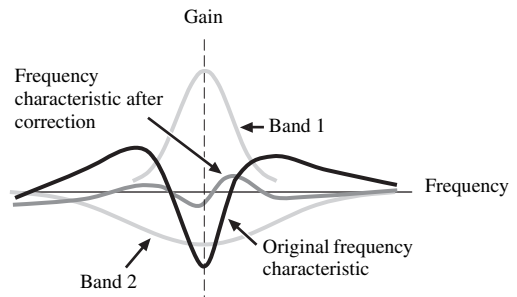

Figure 2



# Specifications

## AUDIO SECTION

- Minimum RMS Output Power for Front, Center, Surround, Surround back  
20 Hz to 20 kHz, 0.06% THD, 8  $\Omega$  ..... 90 W
- Dynamic Power (IHF)  
Front L/R, 8/6/4/2  $\Omega$  ..... 120/155/190/235 W
- Maximum Useful Output Power (JEITA)  
[Asia, General, China and Korea models]  
1 kHz, 10% THD, 6  $\Omega$  ..... 130 W
- Maximum Output Power [U.K., Europe and Asia models]  
1 kHz, 0.7% THD, 4  $\Omega$  ..... 140 W
- Dynamic Headroom  
8  $\Omega$  ..... 1.4 dB
- IEC Output Power [U.K., Europe and Asia models]  
Front L/R, 1 kHz, 0.06% THD, 8  $\Omega$  ..... 100 W
- Damping Factor (IHF)  
Front L/R, SPEAKERS A, 20 Hz to 20 kHz, 8  $\Omega$   
..... 120 or more
- Input Sensitivity/Input Impedance  
PHONO (MM) ..... 3.5 mV/47 k $\Omega$   
CD, etc. .... 200 mV/47 k $\Omega$   
MULTI CH INPUT ..... 200 mV/47 k $\Omega$
- Maximum Input Voltage  
PHONO (MM)  
1 kHz, 0.1% THD ..... 60 mV or more  
CD, etc.  
Effect On, 1 kHz, 0.5% THD ..... 2.3 V or more
- Rated Output Voltage/Output Impedance  
OUT (REC) ..... 200 mV/1.2 k $\Omega$   
PRE OUT ..... 1.0 V/1.2 k $\Omega$   
SUBWOOFER (2ch Stereo, FRONT SP: SMALL)  
..... 1.0 V/1.2 k $\Omega$   
ZONE 2 OUT ..... 200 mV/1.2 k $\Omega$
- Headphone Jack Rated Output/Impedance  
CD, etc. (1 kHz, 50 mV, 8  $\Omega$ ) ..... 150 mV/100  $\Omega$
- Frequency Response  
CD to Front L/R, 10 Hz to 100 kHz  
..... +0/-3 dB
- RIAA Equalization Deviation  
PHONO (MM) ..... 0  $\pm$  0.5 dB
- Total Harmonic Distortion  
PHONO (MM) to OUT (REC)  
20 Hz to 20 kHz, 1 V ..... 0.02% or less  
CD, etc. to Front L/R  
2ch Stereo, 20 Hz to 20 kHz, 50 W, 8  $\Omega$  ..... 0.06% or less
- Signal to Noise Ratio (IHF-A Network)  
PHONO (MM, 5 mV) to Front L/R  
[Australia, U.K., Europe, Korea and Asia models]  
..... 81 dB or more  
[Other models] ..... 86 dB or more  
CD, etc. (Effect Off, 250 mV) to Front L/R  
..... 100 dB or more
- Residual Noise (IHF-A Network)  
Front L/R ..... 150  $\mu$ V or less
- Channel Separation (1 kHz/10 kHz)  
PHONO (shortened) to Front L/R ..... 60 dB/55 dB or more  
CD, etc.  
(5.1 k $\Omega$  shortened) to Front L/R ..... 60 dB/45 dB or more

- Volume Control ..... MUTE/-80 dB to 16.5 dB
- Tone Control (Front L/R)  
BASS Boost/Cut .....  $\pm$ 10 dB/50 Hz  
BASS Turnover Frequency ..... 350 Hz  
TREBLE Boost/Cut .....  $\pm$ 10 dB/20 kHz  
TREBLE Turnover Frequency ..... 3.5 kHz
- Filter Characteristics (fc=40/60/80/90/100/110/120/160/200 Hz)  
H.P.F.  
(FRONT SP, CENTER SP, SUR. L/R SP, SUR. B L/R SP:  
SMALL/SML) ..... 12 dB/oct.  
L.P.F. (Subwoofer) ..... 24 dB/oct.

## VIDEO SECTION

- Video Format (Gray Back)  
[U.S.A., Canada, General and Korea models] ..... NTSC  
[U.K., Europe, Australia, Asia and China models] ..... PAL
- Video Format (Video Conversion) ..... NTSC/PAL
- Signal Level  
Composite ..... 1 Vp-p/75  $\Omega$   
S-video ..... 1 Vp-p/75  $\Omega$  (Y), 0.286 Vp-p/75  $\Omega$  (C)  
Component ..... 1 Vp-p/75  $\Omega$  (Y), 0.7 Vp-p/75  $\Omega$  (Pb/P<sub>R</sub>)
- Maximum Input Level (Video Conversion Off)  
..... 1.5 Vp-p or more
- Signal to Noise Ratio  
..... 50 dB or more
- Frequency Response (MONITOR OUT)  
Component (Video Conversion Off)  
..... 5 Hz to 60 MHz, -3 dB

## FM SECTION

- Tuning Range  
[U.S.A. and Canada models] ..... 87.5 to 107.9 MHz  
[Asia and General models] ..... 87.5/87.50 to 108.0/108.00 MHz  
[Other models] ..... 87.50 to 108.00 MHz
- 50 dB Quieting Sensitivity (IHF)  
Mono ..... 2.8  $\mu$ V (20.2 dBf)
- Signal to Noise Ratio (IHF)  
Mono/Stereo ..... 73 dB/70 dB
- Harmonic Distortion (1 kHz)  
Mono/Stereo ..... 0.5%
- Antenna Input (unbalanced) ..... 75  $\Omega$

## AM SECTION

- Tuning Range  
[U.S.A. and Canada models] ..... 530 to 1710 kHz  
[Asia and General models] ..... 530/531 to 1710/1611 kHz  
[Other models] ..... 531 to 1611 kHz



**GENERAL**

- Power Supply
  - [U.S.A. and Canada models] ..... AC 120 V, 60 Hz
  - [General model]
    - ..... AC 110/120/220/230–240 V, 50/60 Hz
  - [Asia model]
    - ..... AC 220/230–240 V, 50/60 Hz
  - [China model] ..... AC 220 V, 50 Hz
  - [Korea model] ..... AC 220 V, 60 Hz
  - [Australia model] ..... AC 240 V, 50 Hz
  - [U.K. and Europe models] ..... AC 230 V, 50 Hz
- Power Consumption
  - [U.S.A. and Canada models] ..... 380 W/480 VA
  - [Other models] ..... 390 W
- Standby Power Consumption ..... 0.1 W or less
- Maximum Power Consumption [General model only]
  - 6ch, 10% THD ..... 800 W
- AC Outlets
  - [U.S.A., Canada, and China models]
    - ..... 2 (Total 100 W maximum)
  - [Asia, General and Europe models] ..... 2 (Total 50 W maximum)
  - [Australia and U.K. models] ..... 1 (Total 100 W maximum)
- Dimensions (W x H x D) ..... 435 x 171 x 393 mm  
(17-1/8 x 6-3/4 x 15-1/2 in)
- Weight ..... 11.6 kg (25 lbs 9 oz)

\* Specifications are subject to change without notice.

■ Front panel

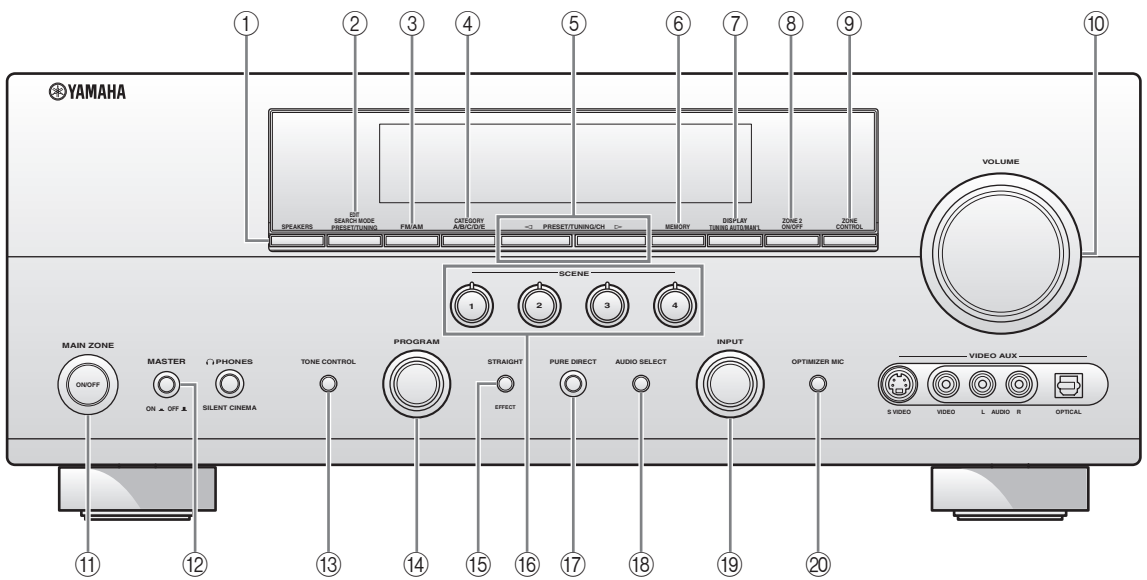

■ Remote control

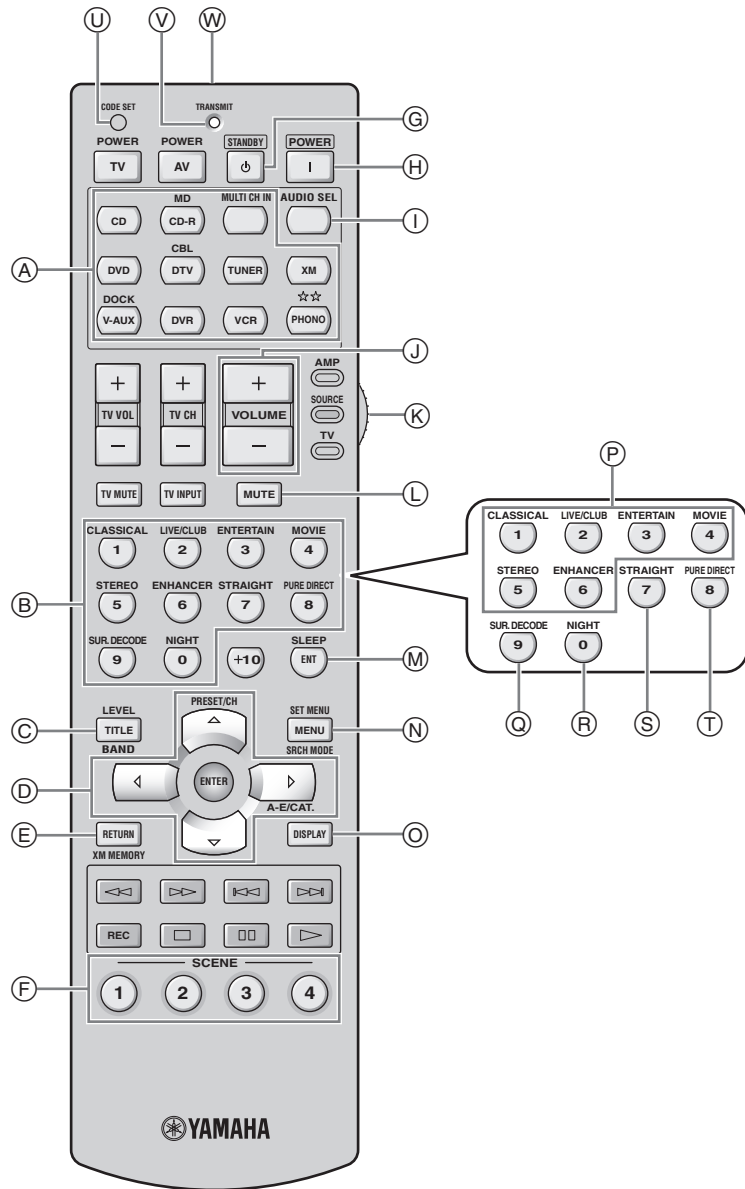

# Index

## ■ Numerics

- 1 SOUND MENU, Manual setup ..... 69
- 2 INPUT MENU, Manual setup ..... 69
- 2ch Enhancer, Sound field program .... 46
- 2ch STEREO, Sound field program .... 46
- 3 OPTION MENU, Manual setup ..... 70
- 7ch Enhancer, Sound field program .... 46
- 7ch STEREO, Sound field program .... 46
- 96/24 indicator ..... 27

## ■ A

- A)DISPLAY SET, Option menu ..... 81
- A)I/O ASSIGNMENT, Input menu ..... 78
- A)SPEAKER SET, Sound menu ..... 72
- AC OUTLET(S) (SWITCHED) ..... 24
- Action Game, Sound field program .... 44
- Advanced setup ..... 92
- Advanced sound configurations ..... 61
- Adventure, Sound field program ..... 45
- ALL CH SEARCH, XM tuning ..... 55
- All Channel Search mode,
  - XM tuning ..... 55
- All remote control codes resetting ..... 88
- AM antenna connection ..... 24
- AM tuning ..... 50
- Amplifier function OSD display time,
  - Display settings ..... 81
- Audio cable plugs ..... 15
- Audio components connection ..... 21
- AUDIO DELAY, Audio settings ..... 76
- Audio delay, Audio settings ..... 76
- Audio information ..... 41
- Audio input jacks selection ..... 39
- AUDIO jacks ..... 15
- Audio jacks ..... 15
- AUDIO SELECT ..... 39
- Audio select, Option menu ..... 82
- Audio settings, Sound menu ..... 76
- Audio signal flow ..... 17
- AUTO SETUP ..... 28, 69
- Auto setup ..... 69
- AUTO: RESULT ..... 31
- Automatic preset tuning,
  - FM/AM tuning ..... 51
- Automatic tuning, FM/AM tuning ..... 50
- Available decoders
  - with Sound field programs ..... 66

## ■ B

- B)INPUT RENAME, Input menu ..... 79
- B)MEMORY GUARD,
  - Option menu ..... 82
- B)SPEAKER LEVEL, Sound menu .... 74
- Bass cross over, Speaker settings ..... 74
- BGV, Multi channel input settings ..... 80
- BI-AMP, Advanced setup ..... 95
- Bi-Amplifier, Advanced setup ..... 95

## ■ C

- C)AUDIO SELECT, Option menu ..... 82
- C)SP DISTANCE, Sound menu ..... 75
- C)VOLUME TRIM, Input menu ..... 80
- C.IMAGE, Decoder parameter ..... 68
- Cable plugs ..... 15
- CAT SEARCH, XM tuning ..... 55
- CD player connection ..... 21
- Cellar Club, Sound field program ..... 43
- CENTER GEQ, Equalizer ..... 76
- Center graphic equalizer, Equalizer .... 76
- CENTER PRE OUT jack
  - connection ..... 22
- CENTER SP, Speaker settings ..... 73
- Center speaker level,
  - Sound field parameter ..... 66
- Center speaker, Speaker settings ..... 73
- CENTER WIDTH,
  - Decoder parameter ..... 68
- Chamber, Sound field program ..... 43
- Charge on standby,
  - iPod universal dock setting ..... 83
- CLASSICAL, Sound field category ..... 43
- CMPNT-V INPUT,
  - Input/output assignment ..... 78
- COAXIAL IN,
  - Input/output assignment ..... 79
- COAXIAL INPUT jack assignment,
  - Input/output assignment ..... 79
- COMPONENT VIDEO jack assignment,
  - Input/output assignment ..... 78
- COMPONENT VIDEO jacks ..... 15
- Compressed Music Enhancer ..... 46
- Compressed Music Enhancer effect level,
  - Sound field parameter ..... 66
- Connection, AM antenna connection ... 24
- Connection, audio components ..... 21
- Connection, CD player ..... 21
- Connection,
  - CENTER PRE OUT jack ..... 22
- Connection, DVD player ..... 19
- Connection, DVD recorder ..... 20
- Connection, External amplifier ..... 22
- Connection, external decoder ..... 22
- Connection, FM antenna ..... 24
- Connection,
  - FRONT PRE OUT jacks ..... 22
- Connection, iPod universal dock ..... 23
- Connection, Multi-format player ..... 22
- Connection, Power cable ..... 24
- Connection, projector ..... 18
- Connection, PVR ..... 20
- Connection, set-top boxes ..... 20
- Connection, speaker cable ..... 14
- Connection,
  - SUBWOOFER PRE OUT jack ..... 22
- Connection,
  - SUR.BACK PRE OUT jacks ..... 22

- Connection,
  - SURROUND PRE OUT jacks ..... 22
- Connection, Turntable ..... 21
- Connection, TV monitor ..... 18
- Connection, VCR ..... 20
- CROSSOVER, Speaker settings ..... 74
- CT LEVEL, Sound field parameter .... 66
- Current status display ..... 39

## ■ D

- D)DECODER MODE, Input menu .... 80
- D)EQUALIZER, Sound menu ..... 75
- D)PARAM.INI, Option menu ..... 82
- Decoder descriptions ..... 67
- Decoder indicators ..... 26
- Decoder mode ..... 80
- Decoder mode, Input menu ..... 80
- Decoder select mode, Decoder mode .. 80
- Decoder selection ..... 66
- Decoder type,
  - Extended surround decoders ..... 77
- DIALG.LIFT,
  - Sound field parameter ..... 62
- Dialogue left,
  - Sound field parameter ..... 62
- DIGITAL COAXIAL jacks ..... 15
- DIGITAL OPTICAL jacks ..... 15
- DIMENSION, Decoder parameter ..... 68
- DIMMER, Display settings ..... 81
- Dimmer, Display settings ..... 81
- Direct number access mode,
  - XM tuning ..... 55
- DIRECT, Sound field parameter ..... 66
- DISPLAY SET ..... 81
- Display settings, Option menu ..... 81
- DIST, Auto setup result ..... 30
- DISTANCE, Auto setup parameter .... 30
- DOCK indicator ..... 26
- Drama, Sound field program ..... 45
- DSP effect level,
  - Sound field parameter ..... 62
- DSP indicators ..... 26
- DSP LEVEL,
  - Sound field parameter ..... 62
- DTS decoder prioritize setting,
  - Decoder mode ..... 80
- DTS Neo:6 Music ..... 68
- DVD player connection ..... 19
- DVD recorder connection ..... 20
- Dynamic range, Sound menu ..... 76

## ■ E





- E)LFPE LEVEL, Sound menu ..... 76
- E)MULTI CH SET, Input menu ..... 80
- E)ZONE2 SET, Option menu ..... 82
- ENHANCER indicator ..... 26
- ENTERTAINMENT,
  - Sound field category ..... 44
- EQ TYPE SELECT, Equalizer ..... 75

- EQ TYPE, Auto setup parameter ..... 29
- Equalizer type select, Equalizer ..... 75
- Equalizer, Sound menu ..... 75
- EQUALIZING,
  - Auto setup parameter ..... 30
- Extended surround decoders,
  - Sound menu ..... 77
- External amplifier connection ..... 22
- External decoder connection ..... 22
- EXTRA SP ASSIGN,
  - Auto setup parameter ..... 29
- EXTRA SP ASSIGN,
  - Speaker settings ..... 72
- Extra speaker assignment,
  - Auto setup parameter ..... 29
- Extra speaker assignment,
  - Speaker settings ..... 72
- F**
  - F)DYNAMIC RANGE,
    - Sound menu ..... 76
  - F)XM RADIO SET, Option menu ..... 83
  - FL SCROLL, Display settings ..... 81
  - FM antenna ..... 24
  - FM antenna connection ..... 24
  - FM tuning ..... 50
  - FRONT B speaker setting,
    - Speaker settings ..... 72
  - FRONT B speakers setting ..... 72
  - FRONT B, Speaker settings ..... 72
  - Front input,
    - Multi channel input settings ..... 80
  - Front panel display ..... 26
  - Front panel display scroll,
    - Display settings ..... 81
  - FRONT PRE OUT jack connection ..... 22
  - FRONT SP, Speaker settings ..... 73
  - Front speaker set selection ..... 38
  - Front speakers, Speaker settings ..... 73
  - FRONT,
    - Multi channel input settings ..... 80
- G**
  - G)AUDIO SET, Sound menu ..... 76
  - G)DOCK SET, Option menu ..... 83
- H**
  - H)HDMI SET, Sound menu ..... 77
  - Hall in Munich,
    - Sound field program ..... 43
  - Hall in Vienna,
    - Sound field program ..... 43
  - HDMI ..... 16
  - HDMI IN jack assignment,
    - Input/output assignment ..... 79
  - HDMI IN, Input/output assignment ..... 79
  - HDMI indicator ..... 26
  - HDMI setting, Sound menu ..... 77
  - HEADPHONE ..... 76
  - Headphone, Dynamic range ..... 76
  - HEADPHONE,
    - Low-frequency effect level ..... 76
  - Headphone,
    - Low-frequency effect level ..... 76
- Headphones ..... 40
- Headphones indicator ..... 26
- HP, Dynamic range ..... 76
- I**
  - I)EXTD SUR., Sound menu ..... 77
  - Infrared window ..... 27
  - INI VOL., Audio settings ..... 77
  - INI VOL., Zone 2 settings ..... 83
  - INIT.DLY, Sound field parameter ..... 63
  - Initial delay, Sound field parameter ..... 63
  - Initial volume, Audio settings ..... 77
  - INPUT CH,
    - Multi channel input settings ..... 80
  - Input channel and speaker indicators ..... 27
  - Input channel indicators ..... 27
  - Input channels,
    - Multi channel input settings ..... 80
  - Input menu, Manual setup ..... 69
  - Input rename, Input menu ..... 79
  - Input signal indicators ..... 26
  - Input source indicators ..... 26
  - Input source information display ..... 40
  - Input/output assignment, Input menu ..... 78
  - iPod universal dock connection ..... 23
  - iPod universal dock setting ..... 83
  - iPod universal dock setting,
    - Option menu ..... 83
  - iPod use ..... 58
- J**
  - Jacks ..... 15
- L**
  - LEVEL, Auto setup parameter ..... 30
  - LFE indicator ..... 27
  - LFE/BASS OUT, Speaker settings ..... 74
  - LFE/Bass out, Speaker settings ..... 74
  - LIVE/CLUB, Sound field category ..... 43
  - LIVENESS, Sound field parameter ..... 64
  - Liveness, Sound field parameter ..... 64
  - Low-frequency effect level,
    - Sound menu ..... 76
  - LVL, Auto setup result ..... 30
- M**
  - Manual preset tuning,
    - FM/AM tuning ..... 51
  - MANUAL SETUP ..... 69
  - Manual setup ..... 69
  - Manual tuning, FM/AM tuning ..... 50
  - MASTER ON/OFF ..... 25
  - MAX VOL., Audio settings ..... 77
  - MAX VOL., Zone 2 settings ..... 82
  - Maximum volume ..... 77
  - Maximum volume, Audio settings ..... 77
  - Memory guard, Option menu ..... 82
  - MODE,
    - Extended surround decoders ..... 77
  - Mode, Extended surround decoders ..... 77
  - Mono Movie, Sound field program ..... 45
  - MOVIE, Sound field category ..... 45
  - MULTI CH INPUT
    - component selection ..... 38
- MULTI CH INPUT jacks ..... 22
- Multi channel input settings,
  - Input menu ..... 80
- Multi-channel source playback
  - in 2-channel stereo ..... 49
- Multi-channel source playback
  - with headphones ..... 46
- Multi-format player connection ..... 22
- Multi-information display ..... 27
- MULTI-ZONE Configuration ..... 89
- MUSIC ENHANCER,
  - Sound field category ..... 46
- Music Video, Sound field program ..... 44
- MUTE ..... 40
- MUTE indicator ..... 26
- Muting ..... 40
- MUTING TYPE, Audio settings ..... 76
- Muting type, Audio settings ..... 76
- N**
  - Neo:6 Cinema, Decoder type ..... 66, 67
  - Neo:6 Music, Decoder type ..... 67
  - Neural Sur., Decoder type ..... 67
  - NIGHT indicator ..... 26
  - Night listening mode ..... 49
  - Number of speakers,
    - Auto setup result ..... 30
- O**
  - Operation mode selector ..... 27
  - OPTICAL IN,
    - Input/output assignment ..... 79
  - OPTICAL INPUT jack assignment,
    - Input/output assignment ..... 79
  - OPTICAL OUT,
    - Input/output assignment ..... 79
  - OPTICAL OUTPUT jack assignment,
    - Input/output assignment ..... 79
  - OPTIMIZER MIC jack ..... 28
  - Option menu, Manual setup ..... 70
  - OSD SHIFT, Display settings ..... 81
  - OSD shift, Display settings ..... 81
  - OSD-AMP, Display settings ..... 81
  - OSD-SOURCE, Display settings ..... 81
  - Other components controlling
    - by remote control ..... 86
  - Other components controlling,
    - Remote control ..... 86
- P**
  - P.INIT.DLY,
    - Sound field parameter ..... 63
  - P.ROOM SIZE,
    - Sound field parameter ..... 64
  - PANORAMA, Decoder parameter ..... 68
  - Parameter initialization,
    - Option menu ..... 82
  - Parametric equalizer information ..... 107
  - Parametric equalizer type,
    - Auto setup parameter ..... 29
  - Parametric equalizer,
    - Auto setup parameter ..... 30
  - PHONES jack ..... 40
  - PL II Game, Decoder type ..... 67

- PL II Movie, Decoder type ..... 67  
 PL II Music, Decoder type ..... 67  
 PL LEVEL, Sound field parameter ..... 66  
 Playing video sources  
   in the background ..... 40  
 PLII Movie, Decoder type ..... 66  
 PLIIx Game, Decoder type ..... 67  
 PLIIx Movie, Decoder type ..... 66, 67  
 PLIIx Music, Decoder type ..... 67  
 Power cable connection ..... 24  
 PR LEVEL, Sound field parameter ..... 66  
 Presence and surround back speaker  
   indicators ..... 27  
 Presence left speaker level,  
   Sound field parameter ..... 66  
 Presence right speaker level,  
   Sound field parameter ..... 66  
 Presence sound field initial delay,  
   Sound field parameter ..... 63  
 Presence sound field room size,  
   Sound field parameter ..... 64  
 Presence/Surround back channel priority,  
   Speaker settings ..... 72  
 Preset channel setting, XM tuning ..... 56  
 Preset SCENE templates ..... 35  
 Preset Search mode, XM tuning ..... 55  
 PRESET SEARCH, XM tuning ..... 55  
 Preset station selection,  
   FM/AM tuning ..... 52  
 Preset stations exchange,  
   FM/AM tuning ..... 52  
 PRESET, Advanced setup ..... 93  
 PRIORITY, Speaker settings ..... 72  
 PRO LOGIC II Music ..... 68  
 PRO LOGIC IIX Music ..... 68  
 PRO LOGIC, Decoder type ..... 66, 67  
 Projector connection ..... 18  
 Pure Direct ..... 48  
 Pure hi-fi sound ..... 48  
 PVR connection ..... 20
- R**  
 Rear panel ..... 11  
 REMOTE AMP, Advanced setup ..... 93  
 Remote control AMP ID,  
   Advanced setup ..... 93  
 Remote control code default settings ... 87  
 Remote control codes ..... i  
 Remote control codes setting ..... 87  
 Remote control TUNER ID,  
   Advanced setup ..... 94  
 Remote control XM ID,  
   Advanced setup ..... 94  
 REMOTE IN/OUT jacks ..... 23  
 REMOTE TUN, Advanced setup ..... 94  
 REMOTE XM, Advanced setup ..... 94  
 Rename, SCENE template ..... 36  
 Repeat ..... 59  
 Repeat, iPod playback ..... 59  
 Resetting the system ..... 103  
 REV.DELAY,  
   Sound field parameter ..... 65  
 REV.LEVEL,  
   Sound field parameter ..... 65
- REV.TIME,  
   Sound field parameter ..... 65  
 Reverberation delay,  
   Sound field parameter ..... 65  
 Reverberation level,  
   Sound field parameter ..... 65  
 Reverberation time,  
   Sound field parameter ..... 65  
 Roleplaying Game,  
   Sound field program ..... 44  
 ROOM SIZE,  
   Sound field parameter ..... 64  
 Room size, Sound field parameter ..... 64
- S**  
 S VIDEO jacks ..... 15  
 S.INIT.DLY,  
   Sound field parameter ..... 63  
 S.LIVENESS,  
   Sound field parameter ..... 64  
 S.ROOM SIZE,  
   Sound field parameter ..... 64  
 SB INI.DLY,  
   Sound field parameter ..... 63  
 SB L/R SP, Speaker settings ..... 73  
 SB LEVEL,  
   Sound field parameter ..... 66  
 SB LIVENESS,  
   Sound field parameter ..... 64  
 SB ROOM SIZE,  
   Sound field parameter ..... 64  
 SCENE 1 ..... 9  
 SCENE 2 ..... 9  
 SCENE 3 ..... 9  
 SCENE 4 ..... 9  
 SCENE IR code setting,  
   Advanced setup ..... 95  
 SCENE IR, Advanced setup ..... 95  
 SCENE template rename ..... 36  
 Sci-Fi, Sound field program ..... 45  
 Selection, Audio input jacks ..... 39  
 Selection, Front speaker set ..... 38  
 Selection,  
   MULTI CH INPUT component ..... 38  
   Selection, SCENE template ..... 33  
 SET MENU usage ..... 71  
 Set-top box connection ..... 20  
 Shuffle, iPod playback ..... 59  
 SILENT CINEMA ..... 46  
 SILENT CINEMA indicator ..... 26  
 SIZE, Auto setup parameter ..... 30  
 SL LEVEL, Sound field parameter ..... 66  
 SLEEP indicator ..... 27  
 Sleep timer ..... 41  
 Sound field indicators ..... 26  
 Sound field programs ..... 42  
 Sound field programs  
   with headphones ..... 46  
 Sound field programs  
   without surround speakers ..... 46  
 SOUND MENU, Manual setup ..... 72  
 Sound menu, Manual setup ..... 69  
 Source feature OSD display time,  
   Display settings ..... 81
- SP A B indicators ..... 26  
 SP IMP., Advanced setup ..... 93  
 SP, Auto setup result ..... 30  
 SP, Dynamic range ..... 76  
 Speaker cable connection ..... 14  
 Speaker distance,  
   Auto setup parameter ..... 30  
 Speaker distance, Auto setup result ..... 30  
 Speaker distance, Sound menu ..... 75  
 Speaker distances ..... 75  
 Speaker impedance setting ..... 25  
 Speaker impedance,  
   Advanced setup ..... 93  
 Speaker level adjustment ..... 48  
 Speaker level,  
   Auto setup parameter ..... 30  
 Speaker level, Auto setup result ..... 30  
 Speaker level, Sound menu ..... 74  
 Speaker settings, Sound menu ..... 72  
 Speaker size, Auto setup parameter ... 30  
 Speaker wiring,  
   Auto setup parameter ..... 30  
 Speaker, Dynamic range ..... 76  
 SPEAKER,  
   Low-frequency effect level ..... 76  
 Speaker, Low-frequency effect level ... 76  
 Specifications ..... 108  
 Spectacle, Sound field program ..... 45  
 Sports, Sound field program ..... 44  
 SR LEVEL, Sound field parameter ..... 66  
 Standard, Sound field program ..... 45  
 STANDBY CHARGE,  
   iPod universal dock setting ..... 83  
 Standby mode, Main zone ..... 25  
 Standby mode, Zone 2 ..... 91  
 STEREO, Sound field category ..... 46  
 STRAIGHT ..... 47  
 STRAIGHT mode ..... 47  
 SUBWOOFER PHASE,  
   Speaker settings ..... 74  
 Subwoofer phase, Speaker settings ..... 74  
 SUBWOOFER PRE OUT jack  
   connection ..... 22  
 Supplied accessories ..... 3  
 SUPPORT AUDIO, HDMI setting ..... 77  
 Support audio, HDMI setting ..... 77  
 SUR. L/R SP, Speaker settings ..... 73  
 SUR.BACK PRE OUT jack  
   connection ..... 22  
 Surround back left/right speakers,  
   Speaker settings ..... 73  
 Surround back sound field initial delay,  
   Sound field parameter ..... 63  
 Surround back sound field liveness,  
   Sound field parameter ..... 64  
 Surround back sound field room size,  
   Sound field parameter ..... 64  
 Surround back speaker level,  
   Sound field parameter ..... 66  
 Surround decode mode ..... 66  
 SURROUND DECODE,  
   Decoder category ..... 67  
 Surround left speaker level,  
   Sound field parameter ..... 66

- Surround left/right speakers,  
Speaker settings ..... 73
- SURROUND PRE OUT jack  
connection ..... 22
- Surround right speaker level,  
Sound field parameter ..... 66
- Surround sound field initial delay,  
Sound field parameter ..... 63
- Surround sound field liveness,  
Sound field parameter ..... 64
- Surround sound field room size,  
Sound field parameter ..... 64
- **T**
- Test tone, Equalizer ..... 75
- TEST, Equalizer ..... 75
- The Bottom Line,  
Sound field program ..... 43
- The Roxy Theatre,  
Sound field program ..... 43
- Tonal quality adjustment ..... 48
- TRANSMIT indicator ..... 27
- Troubleshooting ..... 96
- TU, Advanced setup ..... 95
- Tuner frequency step,  
Advanced setup ..... 95
- Tuner indicators ..... 26
- Turning off ..... 25
- Turning on ..... 25
- Turntable connection ..... 21
- TV Controlling, remote control ..... 85
- TV monitor connection ..... 18
- TYPE,  
Extended surround decoders ..... 77
- **U**
- UNIT, Speaker distance ..... 75
- Unit, Speaker distance ..... 75
- Unprocessed input sources ..... 47
- User presets, Advanced setup ..... 93
- **V**
- VCR connection ..... 20
- VIDEO AUX jacks ..... 23
- VIDEO CONV., Display settings ..... 81
- Video conversion, Display settings ..... 81
- Video information ..... 41
- VIDEO jacks ..... 15
- Video jacks ..... 15
- Video signal flow ..... 17
- Video sources in the background ..... 40
- Virtual CINEMA DSP ..... 46
- VIRTUAL indicator ..... 26
- VOLTAGE SELECTOR ..... 4
- Volume level ..... 30
- VOLUME level indicator ..... 26
- Volume Trim, Input menu ..... 80
- **W**
- WIRING, Auto setup parameter ..... 30
- **X**
- XM ANTENNA, XM Radio setting .... 83
- XM Mini-Tuner Dock ..... 53
- XM Radio antenna,  
XM Radio setting ..... 83
- XM Radio setting, Option menu ..... 83
- XM satellite radio activation ..... 54
- XM Satellite Radio display ..... 57
- XM satellite radio tuning ..... 53
- **Y**
- YPAO indicator ..... 26
- **Z**
- Zone 2 ..... 89
- Zone 2 Initial volume,  
Zone 2 settings ..... 83
- Zone 2 Maximum volume,  
Zone 2 settings ..... 82
- Zone 2 settings, Option menu ..... 82
- Zone B ..... 38
- ZONE2 indicator ..... 26

### About this manual

-  indicates a tip for your operation.
- Some operations can be performed by using either the buttons on the front panel or the ones on the remote control. In case the button names differ between the front panel and the remote control, the button name on the remote control is given in parentheses.
- This manual is printed prior to production. Design and specifications are subject to change in part as a result of improvements, etc. In case of differences between the manual and product, the product has priority.
- “SPEAKERS” or “DVD” (example) indicates the name of the parts on the front panel or the remote control. Refer to the attached sheet or the pages at the end of this manual for the information about each position of the parts.
- The symbol “” with page number(s) indicates the corresponding reference page(s).

# List of remote control codes

## CABLE TV RECEIVER

3M	10033
A-MARK	10008, 10144
ABC	10237, 10003, 10008, 10033
ACCUPHASE	10003
ACORN	10237
ACTION	10237
ACTIVE	10237
AMERICAST	10899
ARCHER	10237
BCC	10276
BELL SOUTH	10899
BRITISH TELECOM	10003
CENTURY	10008
DIRECTOR	10476
DX ANTENNA	11500
FOSGATE	10276
FUJITSU	11497
GE	10144
GENERAL INSTRUMENT	10476, 10810, 10276, 10003
GIBRALTER	10003
GOLDSTAR	10144
HITACHI	10003, 10008, 10033
INSIGHT	10476, 10810
JERROLD	10476, 10810, 10276, 10003
MACOM	10033
MEMOREX	10000
MITSUBISHI	10003
MOTOROLA	11376, 10476, 10810, 10276 11496
NEC	11496
NOVA VISION	10008
NOVAPLEX	10008
PACE	11877, 10877, 10237, 10008
PANASONIC	10000, 10008, 10144, 10107, 10375, 11488
PARAGON	10000, 10008, 10525
PENNEY	10000
PHILIPS	11305, 10317
PIONEER	11877, 10877, 10144, 10533, 11021, 11500, 11782
PULSAR	10000
QUASAR	10000
REGAL	10276
RUNCO	10000
SAMSUNG	10003, 10144
SCIENTIFIC ATLANTA	11877, 10877, 10477, 10237, 10003, 10000, 10008
SONY	11006, 11460
SPRUCER	10144
STARCOM	10003
SUMITOMO	11500, 11503
SUPERCABLE	10276
TORX	10003
TOSHIBA	10000, 11509

UNITED CABLE	10276, 10003
US ELECTRONICS	10276, 10003, 10008
VIDEOWAY	10000
ZENITH	10000, 10525, 10899

## CABLE/PVR COMBINATION

AMERICAST	10899
GENERAL INSTRUMENT	10810
JERROLD	10810
MOTOROLA	11376, 10810
PACE	11877, 10237
PIONEER	11877, 10877
SCIENTIFIC ATLANTA	11877, 10877
SONY	11006
SUPERCABLE	10276
ZENITH	10899

## DBS/PVR COMBINATION

DIRECTV	11377, 10392, 10639, 11142, 11392, 11442, 11640
DISH NETWORK SYSTEM	11505, 10775
DISHPRO	11505, 10775
ECHOSTAR	11505, 10775
EXPRESSVU	10775
HUGHES NETWORK SYSTEMS	11142, 11442
PHILIPS	11142, 11442
PROSCAN	10392
RCA	11392
SAMSUNG	11442
SHARP	11489
SONY	10639, 11640

## SATELLITE RECEIVER

AIWA	11514, 11515
ALPHASTAR	10772
AUSTAR	10879
BELL EXPRESSVU	10775
CHAPARRAL	10216
DIRECTV	11377, 10392, 10566, 10639, 11639, 11142, 10247, 10749, 11749, 10724, 10819, 11856, 11392, 11442, 11640
DISH NETWORK SYSTEM	11505, 11005, 10775, 11775
DISHPRO	11505, 11005, 10775, 11775
DX ANTENNA	11530
ECHOSTAR	11505, 11005, 10775, 11775

ESAT	10879
EXPRESSVU	10775, 11775
FOXTEL	10879, 11356
FUNAI	11377
GE	10392, 10566
GOI	10775, 11775

HITACHI	10749, 10819, 10214, 11250, 11518, 11523, 11525
---------	--

HOUSTON	10775
HTS	10775, 11775
HUGHES NETWORK SYSTEMS	11142, 10749, 11749, 11442

JVC	10775, 10492, 11507, 11531, 11532, 11775
-----	--

LG	11226
MAGNAVOX	10724, 10722
MASPRO	11520, 11530
MATSUSHITA	10214
MEMOREX	10724
MITSUBISHI	10749
MOTOROLA	10856
NEC	10496, 11270, 11519

OPTIMUS	10724
PACE	11356
PANASAT	10879
PANASONIC	10247, 10701, 10214, 11508, 11526, 11527, 11528

PAYSAT	10724
PHILIPS	11142, 10749, 11749, 10775, 10724, 10819, 10722, 11442 11142, 11442
PIONEER	11142, 11442
PROSCAN	10392, 10566
RADIOHACK	10566, 10775
RCA	10392, 10566, 11142, 10775, 10855, 10143, 11392, 11442

SAMSUNG	11377, 11142, 11276, 11442
SANYO	11219
SHARP	10494, 11489, 11513, 11517

SKY	10856
SONY	10639, 11639, 10163, 10275, 10294, 11524, 11640

STAR TRAK	10772
THOMSON	10392, 10566
TIVO	11142, 11442
TOSHIBA	10749, 11749, 10790, 10819, 10486, 11285, 11501, 11516, 11530

UEC	11356
ULTIMATETV	11392, 11640
UNIDEN	10724, 10722
ZENITH	10856, 11856

## TV

A-MARK	20047, 20054, 20160
ACCUSCAN	20047
ACTION	20030
ADMIRAL	20017, 20047, 20051, 20054, 20093, 20179, 20180, 20264, 20463
ADVENT	20761, 20783, 20815, 20817, 20842
ADVENTURI	20000
AGNA	20150
AIKO	20092
AIWA	21180
AKAI	20030, 20060, 20145, 20672, 20702, 20812
ALARON	20170, 20179
ALBA	20037
ALBATRON	20700, 20843
ALFIDE	20672
ALLERON	20030, 20170
AMBASSADOR	20150
AMERICA ACTION	20180
AMERICAN HIGH	20000, 20060
AMSTRAD	20171
AMTRON	20000, 20180
ANAM	20180
ANAM NATIONAL	20161
AOC	20030, 20180
APEX DIGITAL	20156, 20748, 20765, 20767, 20879
AUDINAC	20180
AUDIOVOX	20092, 20179, 20180, 20451, 20623, 20802, 20875
AVENTURA	20171
BAYCREST	20186
BAYSONIC	20180
BEAUMARK	20017, 20030, 20178, 20179
BELCOR	20030
BELL & HOWELL	20054, 20093, 20154, 20179
BENQ	21032
BRADFORD	20180
BROCKWOOD	20030, 20178
BROKSONIC	20180, 20236, 20463
BROTHER	20264
BYD:SIGN	21309, 21311, 21485, 21486
CANDLE	20030, 20186
CAPEHART	20017, 20030, 20036, 20092, 20178
CARNIVALE	20030



CARVER	20054, 20170	EMERSON	20036, 20047, 20150, 20154, 20170, 20171, 20178, 20179, 20180, 20236, 20451, 20463, 20623	INTEQ	20017, 20145	MERMAID	20037
CCE	20037			JBL	20054	MGA	20030, 20150, 20178
CELEBRITY	20000			JCB	20000	MGN TECHNOLOGY	20178
CELERA	20765			JENSEN	20761, 20815, 20817		20178
CHANGHONG	20156, 20765, 20767, 20783			JIL	20030	MICRO GENIUS	20150
CINERAL	20092, 20451	ENVISION	20030	JINXING	20037	MIDLAND	20017, 20047, 20051
CITEK	20047	ESA	20171, 20812	JUTAN	20030	MINATO	20037
CITIZEN	20000, 20030, 20054, 20060, 20092, 20171, 20180, 20186, 20451, 20463	FISHER	20000, 20054, 20154	JVC	20030, 20036, 20053, 20054, 20160, 20653, 20731, 21172, 21253, 21428	MITSUBISHI	20030, 20036, 20093, 20150, 20154, 20160, 20178, 20250, 20836, 21150, 21171, 21182, 21250, 21522
CLARION	20180	FORTRESS	20093	KAMP	20017, 20180	MONIVISION	20700, 20843
CLASSIC	20030, 20092	FUJITSU	20179, 20186, 20683, 20809, 20853, 21181, 21607	KAWASHO	20030	MOTOROLA	20051, 20054, 20093, 20150
COLORTYME	20017, 20030, 20047, 20054, 20060, 20178	FUJITSU GENERAL	20186	KEC	20060, 20180	MTC	20030, 20060, 20092, 20180
COMMERCIAL SOLUTIONS	20047, 21447	FUNAI	20000, 20171, 20179, 20180, 20264, 20342	KENWOOD	20030, 20180	MULTITECH	20179, 20180
CONIC	20178	FUTURETECH	20180	KLH	20156, 20180, 20765, 20767	NAD	20156, 20166, 20178, 20866
CONTEC	20180	GATEWAY	21755, 21756	KLOSS	20030	NEC	20030, 20036, 20047, 20156, 20170, 20178, 20474, 20704, 21182, 21456, 21704
CRAIG	20161, 20171, 20179, 20180	GE	20000, 20030, 20047, 20051, 20060, 20178, 20451, 21147, 21347, 21447	KONKA	20180	NETTV	21755
CROSLEY	20000, 20030, 20054, 20171, 20180			KTV	20030, 20180, 20463	NIKKO	20030, 20092, 20178
CROWN	20093, 20180, 20672			LARK	20154	NIKKODO	20030, 20092, 20178
CROWN MUSTANG	20672			LG	20030, 20054, 20060, 20178, 20442, 20700, 20856, 21178, 21265, 21378	NISHI	20030
CURTIS MATHES	21347, 21147, 20702, 20451, 20180, 20179, 20178, 20166, 20154, 20145, 20093, 20060, 20054, 20051, 20047, 20037, 20030, 20000	GEMINI	20047	LLOYD'S	20030, 20179, 20180, 20236	NORCENT	20748, 20824
		GENERAL	20186	LOGIK	20179, 20180, 20236	NTC	20092
		GIBRALTER	20000, 20017, 20030	LUMATRON	20037, 20264	NYON	20000
		GOLDSTAR	20030, 20036, 20037, 20047, 20054, 20178, 21378	LXI	20179, 20178, 20171, 20166, 20156, 20154, 20093, 20060, 20054, 20053, 20051, 20047, 20037, 20036, 20030, 20017, 20000	ONWA	20180
		GOODMANS	20037			OPTIMUS	20030, 20093, 20150, 20154, 20166, 20178, 20180, 20250, 20650
		GPX	20179	MACY	20186	ORION	20017, 20178, 20179, 20180, 20236, 20463, 21463
		GRADIENTE	20053, 20170	MAGNASONIC	20000, 20030, 20054, 20092, 20093, 20156, 20179	PACE	20092
		GRAN PRIX	20179			PACIFIC	20037
		GRANADA	20037	MAGNAVOX	21755, 21454, 21254, 20802, 20706, 20250, 20186, 20180, 20179, 20171, 20154, 20092, 20060, 20054, 20051, 20047, 20037, 20036, 20030, 20000	PALSONIC	20264
		GRUNDIG	20037, 20672, 20683, 20706			PANASONIC	20000, 20030, 20051, 20054, 20156, 20161, 20236, 20250, 20650, 21168, 21175, 21177
		GRUNDY	20179, 20180			PANDA	20706
		GRUNPY	20179, 20180			PAUSA	20179
		HAIER	21034			PAXONIC	20030, 20060
		HALLMARK	20178, 20179, 20180, 20236			PCE	20060, 20156, 20179
		HARLEY DAVIDSON	20000, 20030, 20060, 20178, 20179, 20180			PENNEY	20000, 20030, 20036, 20037, 20047, 20051, 20060, 20156, 20161, 20178, 20250, 21347, 21378
		HARMAN/KARDON	20054	MAJESTIC	20017	PHILCO	20030, 20054, 20145, 20179, 20186, 20463
		HARVARD	20180	MARANTZ	20030, 20037, 20054, 20704, 21454		
		HAVERMY	20093				
		HEATHKIT	20017	MARK	20037		
		HELIOS	20865	MATSUI	20036, 20037		
		HELLO KITTY	20451	MATSUSHITA	20051, 20161, 20250, 20650		
		HISENSE	20748	MAXENT	21755, 21756		
		HITACHI	20000, 20017, 20036, 20047, 20051, 20054, 20145, 20178, 21150, 21245, 21378	MEGAPOWER	20700		
		HYUNDAI	20849, 20865	MEGATRON	20047, 20145, 20178		
		ICE	20264	MEMOREX	20030, 20037, 20150, 20154, 20178, 20179, 20180, 20463		
		IMA	20178, 20179, 20180, 20236				
		INFINITY	20054				
		INNOVA	20037				
		INSIGNIA	20171				

PHILIPS	20030, 20037, 20054, 20171, 20186, 20690, 21254, 21454, 21455	SEARS	20179, 20178, 20171, 20166, 20156, 20154, 20093, 20060, 20054, 20053, 20051, 20047, 20037, 20036, 20030, 20017, 20000	TEKNIKA	20054, 20060, 20092, 20150, 20178, 20179, 20180, 20186, 20463	XR-1000	20154, 20171, 20179, 20180
PILOT	20030, 20051, 20060, 20178			TELECOLOR	20017	YAMAHA	20030, 20650, 20769, 21405, 21406, 21407, 21522
PIONEER	20166, 20679, 20866, 21260			TELEFUNKEN	20702	YORX	20030
POLAROID	20765, 20865	SHARP	20036, 20054, 20093, 20179, 20180, 20256, 20787, 21165	TELETON	20186	ZENITH	20000, 20017, 20030, 20037, 20047, 20092, 20093, 20145, 20160, 20171, 20178, 20463, 20812, 21145, 21265
PORTLAND	20092, 20451			TEVION	20037		
PRECISION	20180, 20236			THOMAS	20047, 20178		
PRIMA	20761, 20783, 20815, 20817	SHENG CHIA	20093	THOMSON	20047, 21447		
PRINCETON	20700	SHIVAKI	20037, 20178	TMK	20178, 20180, 20236		
PRISM	20051, 20250	SIEMENS	20145	TNCI	20017		
PROSCAN	20047, 21347, 21447	SIGNATURE	20030, 20047, 20093, 20179	TOCOM	20156		
PROTEC	20037, 20264	SIMPSON	20030, 20178, 20186	TOSHIBA	21704, 21656, 21456, 21356, 21265, 21256, 21173, 21169, 21156, 21145, 20845, 20650, 20509, 20264, 20166, 20156, 20154, 20150, 20145, 20060, 20036		
PROTON	20178	SINGER	20060, 20092				
PROVISION	20037	SKY-NORTH	20037	TOTEVISION	20051		
PULSAR	20017, 20092	SOLAR DRAPE	20000	TOYOMENKA	20178		
PULSER	20092, 20178	SONY	20000, 20017, 20036, 20053, 20150, 20154, 21100, 21167, 21300, 21651	TRUETONE	20051, 20250		
QUARTZ	20150, 20178			TVS	20463		
QUASAR	20051, 20250, 20650			ULTRA	20092		
R-LINE	20037			UNIVERSAL	20047		
RABBIT	20047			UNIVERSUM	20036, 20037, 20170, 20264, 20474		
RADIOSHACK	20030, 20047, 20150, 20154, 20178, 20180	SOUNDESIGN	20178, 20179, 20180, 20186	V	20864, 20885, 21755, 21756		
RCA	20000, 20047, 20051, 20054, 20090, 20093, 20178, 20679, 21047, 21147, 21247, 21347, 21447, 21547	SPECTRAVISION	20156, 20178, 20179, 20186	VECTOR RESEARCH	20030		
REALISTIC	20030, 20047, 20150, 20154, 20178, 20180	SQUAREVIEW	20171	VICTOR	20036, 20053, 20160, 20653		
REVOX	20037	SR2000	20154, 20171	VIDIKRON	20054		
RUNCO	20017, 20030, 20060	SSS	20180	VIDTECH	20036, 20178		
SAMPO	20030, 20047, 21755, 21756	STARLITE	20180, 20236	VIEWSONIC	20857, 20864, 20885, 21755		
SAMSUNG	20017, 20030, 20036, 20037, 20047, 20054, 20060, 20154, 20178, 20264, 20587, 20702, 20766, 20812, 20814, 21060	STUDIO EXPERIENCE	20843	VIKING	20060		
SANKY	20030, 20060	SUPERSCAN	20093, 20864	VISIO	20864, 20885, 21755, 21756		
SANSUI	20030, 20060, 20463	SUPRE-MACY	20186	VIZIO	20864, 20885, 21756		
SANYO	20000, 20036, 20037, 20047, 20054, 20088, 20154, 20171, 20376, 20424, 20463, 21179, 21755	SUPREME	20000	WARDS	20000, 20017, 20030, 20037, 20047, 20051, 20054, 20093, 20154, 20166, 20178, 20179, 20186, 20236, 20866, 21156		
SAVILLE	20060	SV2000	20054	WAYCON	20156		
SCOTCH	20178	SVA	20587, 20748, 20865, 20870, 20871	WELTON	20178		
SCOTT	20030, 20178, 20179, 20180, 20236	SYLVANIA	20000, 20030, 20036, 20037, 20047, 20051, 20054, 20092, 20154, 20171, 20178, 20179, 20186	WESTINGHOUSE	20000, 20451, 20885, 20889		
		SYMPHONIC	20000, 20171, 20178, 20179, 20180	WHITE WESTINGHOUSE	20179, 20236, 20451, 20463, 20623, 20889		
		TANDY	20093				
		TATUNG	20000, 20037, 20051, 21756				
		TEAC	20037, 20154, 20264, 20706				
		TECHNICS	20051, 20054, 20250				
		TECHNOL ACE	20179				
		TECHNOVOX	20030				
		TECHWOOD	20051, 20060, 20250				
				WORLD	20180, 20236, 20451, 20463		

---

<b>PVR</b>	
ABS	31972
ALIENWARE	31972
CYBERPOWER	31972
DELL	31972
DIRECTV	30739
GATEWAY	31972
HEWLETT PACKARD	31972
HITACHI	31718
HOWARD COMPUTERS	31972
HP	31972
HUGHES NETWORK SYSTEMS	30739
HUMAX	30739
HUSH	31972
IBUYPOWER	31972
JVC	31279
LINKSYS	31972
MEDIA CENTER PC	31972
MICROSOFT	31972
MIND	31972
MITSUBISHI	31714
NIVEUS MEDIA	31972
NORTHGATE	31972
PANASONIC	30616, 31244, 31732, 31807, 31808, 31809
PHILIPS	30618, 30739
PIONEER	31803
RCA	30880
REPLAYTV	30614, 30616
SAMSUNG	30739
SHARP	31742, 31810
SONIC BLUE	30614, 30616
SONY	30636, 31447, 31448, 31636, 31972
STACK 9	31972
SYSTEMAX	31972
TAGAR SYSTEMS	31972
TIVO	30618, 30636, 30739
TOSHIBA	30828, 31008, 31739, 31972, 31996
TOUCH	31972
VICTOR	31706
VIEWSONIC	31972
VOODOO	31972
ZT GROUP	31972

<b>VCR</b>		<b>ELECTROPHONIC</b>		<b>LXI</b>	30037, 30000, 30042, 30067	<b>PANASONIC</b>	31062, 30035, 30162, 30000, 30225, 30226, 30614, 30616, 31035, 31244, 31292, 31308, 31732, 31807, 31808, 31809
A-MARK	30037, 30240, 30000	EMERALD	30184, 30121	M ELECTRONIC	30240		
ABS	31972	EMEREX	30032	MAGNASONIC			
ADMIRAL	30060, 30048, 30039, 30047, 30104, 30209	EMERSON	30037, 30184, 30240, 30000, 30121, 30043, 30209, 30348, 31278, 31479		30037, 30240, 30000, 31278		
ADVENTURA	30037, 30240, 30000	FISHER	30039, 30047, 30000, 30104	MAGNAVOX	30035, 30037, 30048, 30039, 30081, 30240, 30000, 30226, 30618, 31781	PENNEY	30035, 30162, 30037, 30047, 30081, 30240, 30000, 30042, 30067, 30038, 31035, 31237
AIWA	30037, 30000, 30307, 30348, 31284, 31291, 31332, 31336	FUJI	30035, 30033	MAGNIN	30240		
AKAI	30041	FUJITSU	30045, 30000	MARANTZ	30035, 30081, 30038, 31381	PENTAX	30042
ALBA	30209	FUNAI	30037, 30000, 31333	MARTA	30037	PHILCO	30035, 30081, 30000, 30209
ALIENWARE	31972	GARRARD	30000	MATSUI	30037, 30209, 30348	PHILIPS	30035, 30162, 30048, 30081, 30045, 30000, 30209, 30034, 30616, 30618, 30739, 31381
ALLEGRO	30039	GATEWAY	31972	MATSUSHITA	30035, 30162, 30081, 30226		
AMERICAN HIGH		GE	30060, 30035, 30048, 30240, 30000, 30807, 31035, 31060	MEDIA CENTER PC			
AMSTRAD	30000	GEMINI	30060		31972		
ANAM NATIONAL		GENERAL	30045	MEDION	30348		
	30226	GENEXXA	30037, 30000	MEI	30035	PILOT	30037
ASHA	30240	GO VIDEO	30240, 30614	MEMOREX	30035, 30162, 30037, 30048, 30039, 30047, 30240, 30000, 30104, 30209, 30307, 30348, 31237	PIONEER	30162, 30081, 30042, 30067, 31803
ASTRA	30035, 30240	GOLDSTAR	30035, 30037, 30039, 30000, 30038, 31237				
AUDIOVOX	30037, 30038	GOODMANS	30037, 30081, 30000	METZ	30037	POLK AUDIO	30081
AVIS	30000	GRADIENTE	30000	MGA	30060, 30240, 30043	PROFITRONIC	
BEAUMARK	30240	GRANADA	30081, 30042	MGN TECHNOLOGY	30240		30240
BELL & HOWELL		GRUNDIG	30081, 30034, 30226	MICROSOFT	31972	PROSCAN	30060, 31060
	30035, 30048, 30039, 30000, 30104	HARLEY DAVIDSON	30000	MIDLAND	30240	PROTEC	30000
BROKSONIC	30184, 30121, 30209, 30348, 31479	HARMAN/KARDON	30081, 30038	MIND	31972	PULSAR	30039, 30240
CALIX	30037	HEWLETT PACKARD	31972	MINOLTA	30042	PULSER	30240
CANDLE	30037, 30038	HI-Q	30035, 30047, 30000	MITSUBISHI	30060, 30048, 30047, 30000, 30042, 30067, 30043, 30041, 30807, 31343, 31714	QUARTZ	30035, 30047
CANON	30035, 30034	HITACHI	30035, 30037, 30045, 30000, 30042, 30041, 30166, 31286, 31326, 31718	MOTOROLA	30035, 30048	QUASAR	30035, 30162, 30226, 31035
CARRERA	30240	HOWARD COMPUTERS		MTC	30240, 30000	RADIOSHACK	
CARVER	30035, 30081	HP	31972	MTX	30000		30035, 30162, 30037, 30048, 30047, 30240, 30000, 30104
CITIZEN	30035, 30037, 30240, 30000, 30209, 31278	HUGHES NETWORK SYSTEMS	30042, 30739	MULTITECH	30039, 30000	RADIX	30037
CLASSIC	30037	HUMAX	30739	NAD	30240, 30104	RANDEX	30037
COLORTYME	30060, 30035, 30045	HUSH	31972	NEC	30104, 30067, 30041, 30038	RCA	30060, 30035, 30048, 30240, 30045, 30000, 30042, 30166, 30807, 30880, 31035, 31060
COLT	30000	IBUYPOWER	31972	NIKKO	30037	REALISTIC	30035, 30162, 30037, 30048, 30047, 30240, 30000, 30104, 30121
CRAIG	30037, 30047, 30240	ITT NOKIA	30240, 30041	NIKKODO	30037	REPLAYTV	30614, 30616
CRITERION	30000	JANEIL	30240	NIKON	30034	RICAVISION	31972
CROSLEY	30035, 30081, 30000	JENSEN	30067, 30041	NISHI	30240	RICOH	30034
CURTIS MATHES		JVC	30067, 30041, 31279, 31299, 31329	NIVEUS MEDIA		RUNCO	30039
	30060, 30035, 30162, 30240, 30000, 30041, 31035	KEC	30037	NOBLEX	30240	SAMSUNG	30060, 30240, 30045, 30000, 30038, 30739, 31014
CYBERNEX	30240	KENWOOD	30067, 30041, 30038	NORTHGATE	31972		
CYBERPOWER		KODAK	30035, 30037	OLYMPUS	30035, 30162, 30104, 30226	SAMTRON	30240
	31972	KTV	30000	OPTIMUS	31062, 30035, 30162, 30037, 30048, 30047, 30240, 30000, 30104	SANKY	30048, 30039
DAEWOO	30037, 30045, 31278	LG	30037, 30240, 30038	ORION	30184, 30240, 30000, 30104, 30121, 30209, 31479	SANSUI	30240, 30000, 30067, 30209, 30041, 31479
DAYTRON	30037	LIFETEC	30348	PANAMA	30035	SANYO	30047, 30240, 30000, 30104, 31330, 31331
DELL	31972	LINKSYS	31972			SCOTT	30184, 30045, 30121, 30043
DENON	30081, 30042	LLOYD'S	30240, 30000, 30038				
DERWENT	30041	LOEWE	30081				
DIRECTV	30739	LOGIK	30240, 30000				
DUAL	30000						
DURABRAND	30039, 30038						
DYNATECH	30240, 30000						
ELECTROHOME							
	30060, 30037, 30240, 30000, 30043, 30209						

SEARS	30060, 30035, 30162, 30037, 30048, 30039, 30047, 30033, 30045, 30000, 30042, 30104, 30067, 30043, 30209, 30041, 30034, 31237	VECTOR	30045	CRAIG	40831	KOSS	40651, 41061
		VECTOR RESEARCH		CREATIVE	40503, 40539	LASONIC	40627, 40798
			30184, 30038	CURTIS MATHES		LECSON	41533
		VICTOR	30067, 30041, 31299, 31706		41087	LENOXX	41127
		VIDEO CONCEPTS		CYBERHOME	40816, 40874, 41023, 41024, 41117, 41129	LG	40591, 40741, 40801, 40869, 41600
		VIDEOMAGIC	30045			LITEON	41058, 41158, 41416, 41440
		VIDEOSONIC	30240, 30000	CYTRON	40705		
SHARP	30048, 30047, 30032, 30000, 30807, 31285, 31742, 31810	VIEWSONIC	31972	DAEWOO	40784, 40705, 40770, 40869, 41169, 41172	LOEWE	40741
		VILLAIN	30000			LOGIX	40783
		VOODOO	31972	DANSAI	40770	MAGNASONIC	
SHINTOM	30039, 30240, 30000	WARDS	30060, 30035, 30037, 30048, 30047, 30081, 30033, 30240, 30045, 30000, 30042, 30043, 30041, 30038	DAYTEK	40872		40651, 40675
				DECCA	40770	MAGNAVOX	40503, 40539, 40646, 40675, 40821, 41268
SHOGUN	30240			DENON	40490, 40634, 41282, 41634		
SIEMENS	30037, 30104			DENVER	40778	MARANTZ	40503, 40539, 40675, 41627
SIGNATURE	30060, 30035, 30037, 30048, 30000	WHITE WESTINGHOUSE	30000, 30209	DIGITREX	40672	MCINTOSH	41533
				DISNEY	40675, 41270	MEDION	40651
SINGER	30037, 30240	WORLD	30209	DIVIDO	40705	MEMOREX	40695, 40831, 41270
SONIC BLUE	30614, 30616	XR-1000	30035, 30240, 30000	DUAL	40675	MICROSOFT	40522, 41708
SONY	30035, 30047, 30032, 30033, 30000, 30067, 30034, 30226, 30636, 31232, 31295, 31296, 31447, 31448, 31636, 31972	YAMAHA	30041, 30038	DURABRAND	41127	MINATO	40752
		ZENITH	30037, 30039, 30033, 30000, 30209, 30041, 30034, 31479	DVD2000	40521	MINTEK	40839, 40717
		ZT GROUP	31972	ELECTROHOME		MITSUBISHI	41521, 40521, 41403, 41629
					41003	NAD	40591, 40741
SOUNDMASTER	30000			EMERSON	40591, 40675, 40821, 41268	NAIKO	40770
				ENTERPRISE	40591	NEC	40785, 40869, 41404
STACK 9	31972			ENTIVO	40503, 40539	NESA	40717
STS	30042	<b>DVD PLAYER</b>		ENZER	40770	NEXSTECH	41402
SV2000	30000	3D LAB	40503, 40539	ESA	40821, 41268	NORCENT	41003, 40872, 41107
SVA	30000	ACCURIAN	41416	FIRSTLINE	40651		
SYLVANIA	30035, 30081, 30000, 30043, 31781	ADVENT	41016	FISHER	40670	ONKYO	40503, 40627, 40792, 41612, 41627
		AIWA	40641	FUNAI	40675, 41268		
		AKAI	40695, 40705, 40770, 40899	GATEWAY	41158	OPTIMUS	40571
SYMPHONIC	30240, 30000	ALBA	40672, 40717	GE	40522, 40815, 40717	ORION	41695
SYSTEMAX	31972	ALCO	40790	GO VIDEO	40573, 40744, 40717, 40741, 40783, 40869, 41044, 41075, 41099, 41158, 41304, 41730	ORITRON	40651
TAGAR SYSTEMS	31972	ALLEGRO	40869			PALSONIC	40672
		AMPHION MEDIA WORKS		GOLDSTAR	40741, 40801, 40869	PANASONIC	40503, 40490, 40571, 40703, 41010, 41011, 41282, 41362, 41462, 41490, 41632, 41641, 41762
TANDY	30000, 30104	AMW	40872			PHILIPS	40503, 40539, 40646, 40675, 40854, 41260, 41267, 41354
TATUNG	30048, 30081, 30000, 30067, 30041	APEX DIGITAL		GOODMANS	40790	PIANODISC	41024
			40533, 40672, 40717, 40755, 40794, 40796, 40797, 40830, 41004, 41020, 41056, 41061, 41100	GRADIENTE	40490, 40651	PIONEER	40525, 40571, 40631, 40638, 41475, 41476, 41571
TEAC	30000, 30067, 30041	ARRGO	41023	GREENHILL	40717		
		ASPIRE DIGITAL		GRUNDIG	40539, 40705	POLAROID	41020, 41061, 41086
TECHNICS	30035, 30162, 30037, 30000	AUDIOVOX	40717, 40790	HARMAN/KARDON	40582, 40702		
TEKNIKA	30035, 30037, 30000	BEL CANTO DESIGN	41571	HITACHI	40573, 40664, 41247, 41664, 41764	POLK AUDIO	40539
			41571			PORTLAND	40770
TELECORDER	30240	BLAUPUNKT	40717	IRT	40783	PRESIDIAN	40675
TELEFUNKEN	30041	BLUE PARADE	40571	JBL	40702	PRIMA	41016
THOMAS	30000	BLUE SKY	40695	JENSEN	41016	PROCEED	40672
THOMSON	30060, 30041	BRANDT	40651	JVC	40558, 40623, 40867, 41164, 41241, 41275, 41590, 41592, 41594	PROSCAN	40522
TIVO	30618, 30636, 30739, 31996	BROKSONIC	40695			PROVISION	40778
		BYD:SIGN	40872			QWESTAR	40651
TMK	30240, 30000	CALIFORNIA AUDIO LABS				RADIONETTE	40741
TNIX	30037	CELESTIAL	41020			RADIOSHACK	
TOCOM	30240	CENTREX	40672, 41004	KAWASAKI	40790		40571
TOSHIBA	30240, 30045, 30000, 30042, 30043, 30209, 30041, 30828, 30845, 31008, 31145, 31323, 31739, 31972, 31996	CINEA	40831	KENWOOD	40490, 40534	RCA	40522, 40571, 40717, 40790, 40822, 41022, 41132
		CINEVISION	40876, 40869	KLH	40717, 40790, 41020, 41149		
TOTEVISION	30037, 30240	CITIZEN	41003, 41277	KLOSS	40533		
TOUCH	31972	CLAIRTONE	40571				
TRIX	30037	COBY	40778, 41086, 41107				
ULTRA	30045						
UNITECH	30240						

REALISTIC 40571  
 REOC 40752  
 RIO 40869  
 ROTEL 40623  
 ROWA 41004  
 SABA 40651  
 SAMPO 40752  
 SAMSUNG 40490, 40573,  
 40744, 40820,  
 40899, 41044,  
 41075, 41599  
 SANSUI 40695, 41695  
 SANYO 40670, 40675,  
 40695, 41583  
 SCHNEIDER 40783  
 SCHWAIGER 40752  
 SENSORY SCIENCE  
 41158  
 SHARP 40630, 40675,  
 40752, 41256,  
 41556, 41642,  
 42002  
 SHARPER IMAGE  
 41117  
 SHERWOOD 40770  
 SHINSONIC 40533, 40839  
 SLIM ART 40784  
 SONIC BLUE 40573, 40783,  
 40869, 41099  
 SONY 40533, 41533,  
 40864, 40772,  
 41033, 41069,  
 41070, 41431,  
 41633  
 SUPERSCAN 40821  
 SVA 40717  
 SYLVANIA 40675, 40821,  
 41268  
 SYMPHONIC 40675, 40821,  
 41268  
 TATUNG 40770  
 TEAC 40571, 40717,  
 40790  
 TECHNICS 40490, 40703  
 TECHNIKA 40770  
 TEVION 40651  
 THETA DIGITAL  
 40571  
 THOMSON 40522  
 TOSHIBA 40503, 40573,  
 40539, 40695,  
 41045, 41154,  
 41510, 41595,  
 41639  
 UNIMAX 40770  
 UNIVERSUM 40591  
 URBAN CONCEPTS  
 40503, 40539  
 US LOGIC 40839  
 VENTURER 40790  
 VICTOR 41241, 41597  
 WYSE 41652  
 XBOX 40522, 41708  
 YAMAHA 40490, 40539,  
 40545, 41282,  
 42000, 42001  
 YAMAKAWA 40872  
 ZENITH 40503, 40591,  
 40741, 40869  
 ZEUS 40784

## LD PLAYER

AIWA 40203  
 CARVER 40064  
 DENON 40059, 40172,  
 40241  
 DISCO VISION  
 40023  
 FUNAI 40203  
 HITACHI 40023  
 KENWOOD 40236, 40258  
 MAGNAVOX 40064, 40217,  
 40241  
 MARANTZ 40064  
 MITSUBISHI 40059, 40241  
 NAD 40059  
 OPTIMUS 40059  
 PANASONIC 40204  
 PHILIPS 40064  
 PIONEER 40059, 40023,  
 40241  
 QUASAR 40204  
 REALISTIC 40203  
 SEGA 40023  
 SHARP 40001  
 SONY 40193, 40201  
 TECHNICS 40204  
 TOSHIBA 40059  
 VICTOR 40245  
 WARDS 40059  
 YAMAHA 40217

## DVD RECORDER

ACCURIAN 51416  
 APEX DIGITAL  
 51056  
 ASPIRE DIGITAL  
 51168  
 COBY 51086  
 CYBERHOME 51129  
 DENON 50490  
 EMERSON 50675  
 FUNAI 50675  
 GATEWAY 51158  
 GO VIDEO 50741, 51158,  
 51304, 51730  
 HITACHI 51664, 51764  
 JVC 51164, 51275  
 LG 50741  
 LITEON 51158, 51416,  
 51440  
 MAGNAVOX 50646, 50675  
 MITSUBISHI 51629  
 PANASONIC 50490, 51010,  
 51011  
 PHILIPS 50646  
 PIONEER 50631, 51475,  
 51476  
 POLAROID 51086  
 RCA 50522  
 SAMSUNG 50490  
 SENSORY SCIENCE  
 51158  
 SHARP 50630, 50675,  
 51556, 51642,  
 52002  
 SONY 51033, 51069,  
 51070, 51431  
 SYLVANIA 50675  
 TOSHIBA 51510, 51639  
 VICTOR 51275  
 YAMAHA 52001  
 ZENITH 50741

## CD PLAYER

ADC 60018  
 ADCOM 60234  
 AIWA 60157  
 AKAI 60083, 60643,  
 61688  
 ALBA 60625  
 ANAM NATIONAL  
 60362  
 ARCAM 60157  
 AUDIO RESEARCH  
 60157  
 CAIRN 60157  
 CALIFORNIA AUDIO LABS  
 60029, 60303  
 CAMBRIDGE SOUNDWORKS  
 60157  
 CARVER 60157  
 CCE 60643  
 CLASSIC 61297  
 CURTIS MATHES  
 60032  
 DENON 60873, 60626,  
 60003, 60034,  
 60766  
 DKK 60000  
 DMX ELECTRONICS  
 60157  
 FISHER 60000, 61325  
 GEMINI 60625  
 GENEXXA 60032  
 GOLDSTAR 61208  
 GPX 61296  
 GRUNDIG 60157  
 HARMAN/KARDON  
 60100, 60157,  
 60083, 61202  
 HITACHI 60032  
 INKEL 60157, 60180  
 INTEGRA 60101  
 JERROLD 60003  
 JVC 60032, 60072,  
 61294  
 KENWOOD 60681, 60826,  
 60626, 60000,  
 60029, 60028,  
 60190, 61683  
 KOSS 61317  
 KRELL 60157  
 KYOCERA 60018  
 LG 61208  
 LINN 60157  
 LUXMAN 60328, 60489  
 MAGNAVOX 60157, 60038,  
 60274  
 MARANTZ 60626, 60029,  
 60157, 60038,  
 60180, 60373,  
 60435  
 MATSUI 60157  
 MCS 60029, 60043  
 MEMOREX 60000, 60032,  
 60468  
 MGA 60083  
 MICROMEGA 60157  
 MIRO 60000  
 MISSION 60157  
 MITSUBISHI 60083, 60808  
 MODULAIRE 60000, 60032,  
 60087, 60180,  
 60468

MTC 60625  
 NAKAMICHI 60147, 60373  
 NEC 60043, 60234  
 NIKKO 60362, 60625  
 NSM 60157  
 ONKYO 60868, 61327,  
 60101, 61685  
 OPTIMUS 61063, 60000,  
 60032, 60087,  
 60468  
 PANASONIC 60029, 60303,  
 60388, 60752,  
 61682  
 PENNEY 60029  
 PHILIPS 60626, 60157,  
 60274  
 PIONEER 61063, 61062,  
 60032, 61087,  
 60468  
 POLK AUDIO 60157  
 PROTON 60157  
 QED 60157  
 QUAD 60157  
 QUASAR 60029  
 RADIOSHACK 60000, 60032,  
 60180, 60468  
 RCA 61062, 60032,  
 60053, 60468  
 REALISTIC 60000, 60032,  
 60087, 60180,  
 60468  
 REVOX 60157  
 ROKSAN 60435  
 ROTEL 60157  
 SAE 60157  
 SAMSUNG 60524  
 SANSUI 60000, 60157  
 SANYO 60000, 60087  
 SHARP 60861, 60034,  
 60180, 61684  
 SHERWOOD 61067, 60180  
 SHURE 60043  
 SONIC FRONTIERS  
 60157  
 SONY 60490, 60000,  
 60100, 61364,  
 60185, 61790  
 STS 60018  
 SUGDEN 60157  
 SYLVANIA 60157  
 SYMPHONIC 60180  
 TAG MCLAREN  
 60157  
 TANDY 60032  
 TDK 61208  
 TEAC 60490, 60180,  
 60362  
 TECHNICS 60029, 60303  
 TECHWOOD 60303, 60362  
 THULE AUDIO  
 60157  
 TOSHIBA 61693, 61694  
 VICTOR 60072  
 WARDS 60032, 60157,  
 60053, 60087  
 YAMAHA 60490, 60868,  
 60888, 60036,  
 61292, 62000,  
 62001  
 YBA 60625  
 YORX 60000

---

**CD RECORDER**

CLASSIC 71297  
DENON 70626  
FISHER 71325  
GPX 71296  
HARMAN/KARDON  
71202  
JVC 71294  
KENWOOD 70626  
LG 71208  
MARANTZ 70626  
PHILIPS 70626  
PIONEER 71062, 71087  
RCA 70053  
SONY 70000, 70100,  
71364  
TDK 71208  
YAMAHA 70888, 71292

---

**MD RECORDER**

DENON 70873  
KENWOOD 70681, 70826,  
71683  
ONKYO 70868, 71685  
OPTIMUS 71063  
PANASONIC 71682  
PIONEER 71063  
SHARP 70861, 71684  
SHERWOOD 71067  
SONY 70490, 71790  
YAMAHA 70490, 70888,  
72001

---

**TAPE DECK**

AIWA 70197  
DENON 70076, 70371,  
70412  
GARRARD 70308, 70309  
JVC 70244, 70273  
KENWOOD 70070, 70205,  
70365  
NIKKO 70365  
ONKYO 70135, 70282  
OPTIMUS 70027  
PANASONIC 70229  
PIONEER 70027, 70099  
RCA 70027  
SHARP 70205, 70371,  
70412  
SONY 70243, 70170,  
70291  
TEAC 70308, 70309,  
70365  
TECHNICS 70229  
TECHNOVOX 70229  
TECHWOOD 70365  
VICTOR 70273  
WARDS 70027  
YAMAHA 70097, 70205,  
70524

---

**TUNER**

ADC 80531  
AIWA 81405, 80158,  
80121, 81388,  
81641  
ALCO 81390  
ANAM 81609, 81074  
ARCAM 81189  
AUDIO PRO 80148

AUDIOTRONIC 81189  
AUDIOVOX 81390  
BOSE 81229, 81933  
CAPETRONIC 80531  
CARVER 81189, 80121  
CURTIS MATHES  
80014, 80080  
DELPHI 81414, 81846  
DENON 81360, 80121,  
80386, 81142  
EMERSON 80531  
FISHER 80219  
GARRARD 80281  
GOLDSTAR 80281  
GRUNDIG 80281  
HARMAN/KARDON  
80110  
HITACHI 80386  
INTEGRA 80135, 80842,  
81298, 81320  
JBL 80110  
JVC 81058, 80074,  
80262, 80464,  
81374, 81495,  
81665  
KAWASAKI 81390  
KENWOOD 80027, 80186,  
80262  
KLH 81390  
LG 80281  
MAGNAVOX 81189, 81269,  
80531, 81266  
MARANTZ 81189, 81269,  
80039, 81671  
MCS 80039  
MICROMEGA 81189  
MYRYAD 81189  
ONKYO 80135, 80380,  
80842, 81298,  
81320, 81677  
OPTIMUS 81023, 80158,  
80074, 80014,  
80080, 80121,  
80186, 80219,  
80531, 81074  
PANASONIC 81308, 81518,  
80039, 80367,  
81275, 81288,  
81316, 81548,  
81633, 81675,  
81763, 81764  
PENNEY 80039  
PHILIPS 81189, 81269,  
81266  
PIONEER 81023, 80014,  
80080, 80150,  
80281, 80531,  
80630, 81284,  
81384, 81678  
POLK AUDIO 81414  
PROSCAN 81254  
QUASAR 80039  
RADIOSHACK 81609  
RCA 81023, 81609,  
81254, 80080,  
80531, 81074,  
81390, 81511  
REALISTIC 81609, 80158,  
80121, 80186  
SANSUI 81189, 80148,  
81764  
SANYO 80219

SHARP 80186, 80262  
SONIC 80281  
SONY 81058, 81441,  
81258, 81759,  
81622, 80158,  
81406, 81558,  
81658, 81758,  
81858  
STEREOPHONICS  
81023  
TEAC 81074, 81390  
TECHNICS 81308, 81518,  
80039, 81384,  
81633, 81675  
TECHWOOD 80281  
THORENS 81189  
TOSHIBA 80080, 80135,  
80842  
VENTURER 81390  
VICTOR 80074  
WARDS 80158, 80014,  
80080  
XM 81406, 81414,  
81846  
YAMAHA 81023, 80176,  
80186, 80376,  
81176, 81276,  
81331, 81375,  
82004  
(TUNER ID1) 82005  
(TUNER ID2) 81949  
(XM ID1) 82006  
(XM ID2) 82007  
ZENITH 80281

---

**OTHER AUDIO ACCESSORIES**

YAMAHA 82001, 82002  
(iPod) 82000



© 2007 YAMAHA CORPORATION All rights reserved.

**YAMAHA ELECTRONICS CORPORATION, USA** 6660 ORANGETHORPE AVE., BUENA PARK, CALIF. 90620, U.S.A.  
**YAMAHA CANADA MUSIC LTD.** 135 MILNER AVE., SCARBOROUGH, ONTARIO M1S 3R1, CANADA  
**YAMAHA ELECTRONIK EUROPA G.m.b.H.** SIEMENSSTR. 22-34, 25462 RELLINGEN BEI HAMBURG, GERMANY  
**YAMAHA ELECTRONIQUE FRANCE S.A.** RUE AMBROISE CROIZAT BP70 CROISSY-BEAUBOURG 77312 MARNE-LA-VALLEE CEDEX02, FRANCE  
**YAMAHA ELECTRONICS (UK) LTD.** YAMAHA HOUSE, 200 RICKMANSWORTH ROAD WATFORD, HERTS WD18 7GQ, ENGLAND  
**YAMAHA SCANDINAVIA A.B.** J A WETTERGRENS GATA 1, BOX 30053, 400 43 VÄSTRA FRÖLUNDA, SWEDEN  
**YAMAHA MUSIC AUSTRALIA PTY, LTD.** 17-33 MARKET ST., SOUTH MELBOURNE, 3205 VIC., AUSTRALIA

**YAMAHA CORPORATION**  
Printed in Malaysia  WJ69940

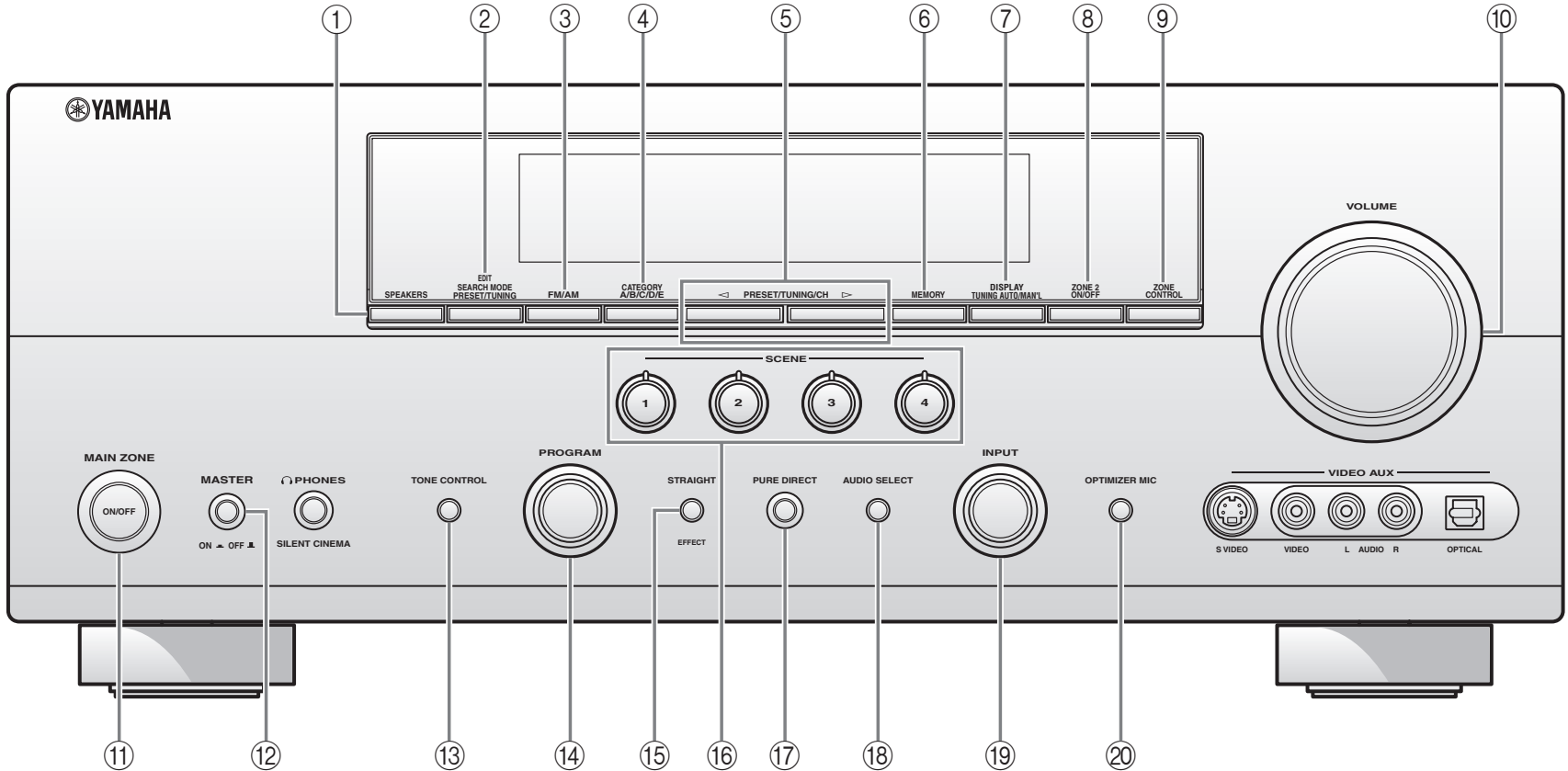
**■ Front panel**



# Remote control

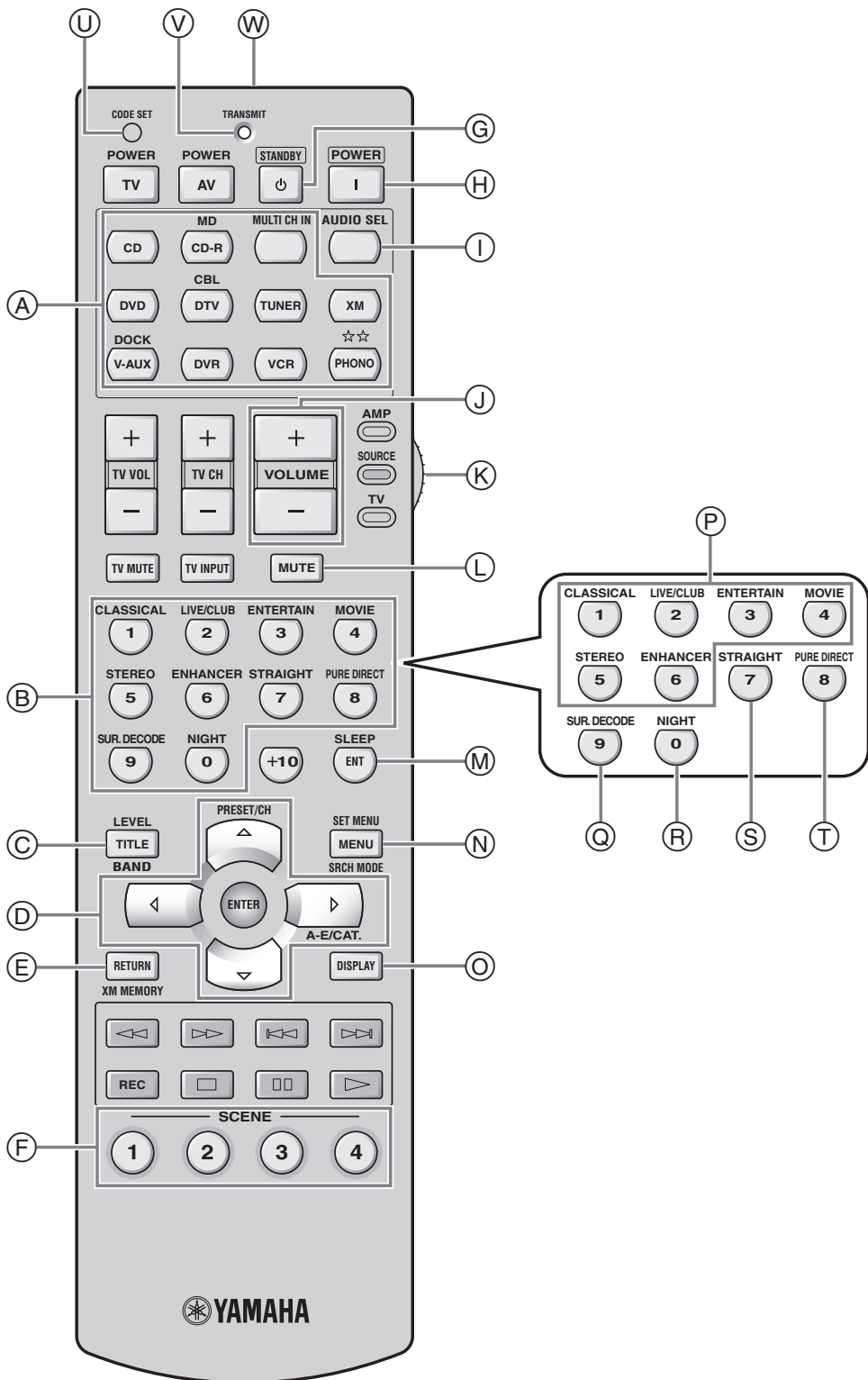

**Page 35 (footnote \*2)****Incorrect**

---

\*2 You can select "V-AUX" as the input source even if your iPod is stationed in the Yamaha Universal Dock connected to this unit. When the SCENE mode is deactivated and your iPod is stationed in the Yamaha Universal Dock, this unit selects "DOCK" as the input source automatically.

**Correct**

---

\*2 You can select "V-AUX" as the input source even if your iPod is stationed in the Yamaha Universal Dock connected to this unit.