



# DSP-A595a

*Natural sound AV Amplifier*

*Amplificateur audio-vidéo*

**OWNER'S MANUAL  
MODE D'EMPLOI  
BEDIENUNGSANLEITUNG  
BRUKSANVISNING  
MANUALE DI ISTRUZIONI  
MANUAL DE INSTRUCCIONES  
GEBRUIKSAANWIJZING**

**SUPPLIED ACCESSORIES**  
**ACCESSOIRES FOURNIS**  
**MITGELIEFERTE ZUBEHÖRTEILE**  
**MEDFÖLJANDE TILLBEHÖR**  
**ACCESSORI IN DOTAZIONE**  
**ACCESORIOS INCLUIDOS**  
**BIJGELEVERDE ACCESSOIRES**

- After unpacking, check that the following parts are included.
- Après le déballage, vérifier que les pièces suivantes sont incluses.
- Nach dem Auspacken überprüfen, ob die folgenden Teile vorhanden sind.
- Kontrollera efter uppäckningen att följande delar finns med.
- Verificare che tutte le parti seguenti siano contenute nell'imballaggio dell'apparecchio.
- Desembalar el aparato y verificar que los siguientes accesorios están en la caja.
- Controleer na het uitpakken of de volgende onderdelen voorhanden zijn.

- Batteries (size AA, R6, UM-3)
- Piles (taille AA, R6, UM-3)
- Batterien (Größe AA, R6, UM-3)
- Batterier (storlek AA, R6, UM-3)
- Batterie (formato AA, R6, UM-3)
- Pilas (tamaño AA, R6, UM-3)
- Batterijen (maat AA, R6, UM-3)

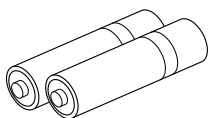

- Remote control  
 Before using the remote control, install the supplied batteries. See page 40 for battery installation.
- Télécommande  
 Avant d'utiliser la télécommande, mettre les piles fournies en place. Pour la mise en place des piles, voir page 84.
- Fernbedienung  
 Legen Sie vor Gebrauch der Fernbedienung die mitgelieferten Batterien ein. Angaben zum Einlegen der Batterien finden Sie auf Seite 128.
- Fjärrkontroll  
 Sätt i de medföljande batterierna innan du använder fjärrkontrollen. Se sidan 172 om hur man sätter i dem.
- Telecomando  
 Prima di usare il telecomando, installare le batterie in dotazione. Per l'installazione delle batterie vedere a pagina 216.
- Control remoto  
 Antes de utilizar el transmisor de control remoto, instálele las pilas suministradas. Para instalar las pilas, consulte la página 260.
- Afstandsbediening  
 Alvorens u de afstandsbediening gaat gebruiken, moet u de bijgeleverde batterijen plaatsen. Zie blz. 304 voor het plaatsen van de batterijen.

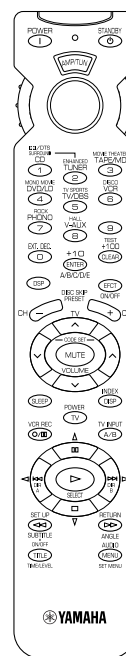

# FEATURES

## 5-Channel Power Amplification

**Minimum RMS Output**  
(0.04% THD, 20 Hz – 20 kHz)

**Main: 65 W + 65 W (8 Ω)**

**Center: 65 W (8 Ω)**

**Rear: 65 W + 65 W (8 Ω)**

## Multi-mode Digital Sound Field Processing

- Digital Sound Field Processor (DSP)
- Dolby Digital Decoder
- Dolby Pro Logic Decoder
- DTS Decoder
- CINEMA DSP: Theater-like Sound Experience by the Combination of YAMAHA DSP Technology and Dolby Digital, Dolby Pro Logic or DTS

- Automatic Input Balance Control for Dolby Pro Logic decoding
- Test Tone Generator for Easier Speaker Balance Adjustment
- Speaker Output Mode Selection
- 6-Channel External Decoder Input for Other Future Formats
- Video Signal Input/Output Capability (Including S Video Connections)
- SLEEP Timer
- Universal Remote Control with Preset

# CONTENTS

SUPPLIED ACCESSORIES .....	2
FEATURES .....	3
CAUTION .....	4

## ● Introduction

FEATURES OF THE SOUND EFFECTS .....	5
CONTROLS AND THEIR FUNCTIONS .....	8

## ● Preparation

SPEAKER SETUP .....	11
CONNECTIONS .....	12
ADJUSTMENTS BEFORE USING THIS UNIT .....	18

## ● Basic Operation

BASIC OPERATION .....	23
SETTING THE SLEEP TIMER .....	27

## ● Information about DSP

SOUND FIELD PROGRAM .....	28
---------------------------	----

## ● Advanced Information

ADJUSTMENTS IN THE "SET MENU" MODE .....	33
--	----

## ● Remote control

REMOTE CONTROL .....	35
SETUP CODES .....	41

TROUBLESHOOTING .....	42
SPECIFICATIONS .....	45

LIST OF MANUFACTURERS' CODES .....	310
------------------------------------	-----

# CAUTION: READ THIS BEFORE OPERATING YOUR UNIT.

1. To assure the finest performance, please read this manual carefully. Keep it in a safe place for future reference.
2. Install this unit in a cool, dry, clean place – away from windows, heat sources, sources of excessive vibration, dust, moisture and cold. Avoid sources of humming (transformers, motors). To prevent fire or electrical shock, do not expose the unit to rain or water.
3. Never open the cabinet. If something drops into the set, contact your dealer.
4. Do not use force on switches, controls or connection wires. When moving the unit, first disconnect the power plug and the wires connected to other equipment. Never pull the wires themselves.
5. The openings on the cover assure proper ventilation of the unit. If these openings are obstructed, the temperature inside the unit will rise rapidly. Therefore, avoid placing objects against these openings, and install the unit in a well-ventilated area to prevent fire and damage.  
  
Be sure to allow a space of at least 20 cm behind, 20 cm on both sides and 30 cm above the top panel of the unit to prevent fire and damage.
6. The voltage used must be the same as that specified on this unit. Using this unit with a higher voltage than specified is dangerous and may result in fire or other accidents. YAMAHA will not be held responsible for any damage resulting from the use of this unit with a voltage other than that specified.
7. Digital signals generated by this unit may interfere with other equipment such as tuners, receivers and TVs. Move this unit farther away from such equipment if interference is observed.
8. Always set the VOLUME control to “∞” before starting the audio source play. Increase the volume gradually to an appropriate level after playback has been started.
9. Do not attempt to clean the unit with chemical solvents; this might damage the finish. Use a clean, dry cloth.
10. Be sure to read the “TROUBLESHOOTING” section regarding common operating errors before concluding that the unit is faulty.
11. When not planning to use this unit for a long period of time (e.g., a vacation), disconnect the AC power plug from the wall outlet.
12. To prevent lightning damage, disconnect the AC power plug and disconnect the antenna cable when there is an electrical storm.
13. Grounding or polarization – Precautions should be taken so that the grounding or polarization of the unit is not defeated.
14. AC outlet  
Do not connect audio equipment to the AC outlet on the rear panel if that equipment requires more power than the outlet is rated to provide.

This unit is not disconnected from the AC power source as long as it is connected to the wall outlet, even if this unit itself is turned off. This state is called the standby mode. In this state, this unit is designed to consume a very small quantity of power.

## For U.K. customers

If the socket outlets in the home are not suitable for the plug supplied with this appliance, it should be cut off and an appropriate 3 pin plug fitted. For details, refer to the instructions described below.

**Note:** The plug severed from the mains lead must be destroyed, as a plug with bared flexible cord is hazardous if engaged in a live socket outlet.

## Special Instructions for U.K. Model

### IMPORTANT

THE WIRES IN MAINS LEAD ARE COLOURED IN ACCORDANCE WITH THE FOLLOWING CODE:

Blue: NEUTRAL

Brown: LIVE

As the colours of the wires in the mains lead of this apparatus may not correspond with the coloured markings identifying the terminals in your plug, proceed as follows:  
The wire which is coloured BLUE must be connected to the terminal which is marked with the letter N or coloured BLACK. The wire which is coloured BROWN must be connected to the terminal which is marked with the letter L or coloured RED.

Making sure that neither core is connected to the earth terminal of the three pin plug.

# FEATURES OF THE SOUND EFFECTS

## Introduction

---

Welcome to the exciting world of digital home entertainment. This unit is one of the most complete and advanced AV amplifiers available. Some of the more advanced features may not be familiar to you, but they are easy to use. State-of-the-art technologies such as Dolby Digital and Digital Theater Systems (DTS) may be new to your home, but you have probably experienced the amazing realism they bring to feature films in theaters around the world.

To make the listening experience even more enjoyable, this unit includes a number of exclusive, digitally created listening environments known as digital sound fields. Choosing a sound field program is like transporting yourself to such venues as an outdoor arena, a European church, or a cozy jazz club. Take some time now to read more about these features and enjoy the new experiences this unit brings to your home theater.

## Digital Sound Field Processing

---

What is it that makes live music so good? Today's advanced sound reproduction technology lets you get extremely close to the sound of a live performance, but the chances are that you'll still notice something missing — the acoustic environment of the live concert hall. Extensive research into the exact nature of the sonic reflections that create the ambience of a large hall has made it possible for YAMAHA engineers to bring you this same sound to your listening room, so you'll feel all the sound of a live concert.

Furthermore, our technicians, armed with sophisticated measuring equipment, have even made it possible to capture the acoustics of a variety of actual concert halls, theaters, etc. from around the world, to allow you to accurately re-create any one of these live performance environments, all in your own home.

## Dolby Pro Logic

---

Dolby Surround has been used in movie theaters since the mid-seventies. It has also been available in home entertainment systems since the late eighties and continues to be a popular format for home theater systems. It uses four discrete channels and five speakers to reproduce realistic and dynamic sound effects: two main channels (left and right), a center channel for dialog, and a rear channel for special sound effects. The rear channel reproduces sound within a narrow frequency range.

Most video tapes and laser discs include Dolby Surround encoding, as do many TV and cable broadcasts. The Dolby Pro Logic decoder built into this unit employs a digital signal processing system that stabilizes each channel for even more accurate sound positioning than is available with standard analog processors.

## Dolby Digital

---

Dolby Digital is the next level of the Dolby Surround sound system that was developed for 35 mm-film movies by employing low bit-rate audio coding.

Dolby Digital is a digital surround sound system that provides completely independent multi-channel audio to you. Dolby Digital provides five full-range channels in what is sometimes referred to as a "3/2" configuration: three front channels (left, center and right), and two surround channels. A sixth bass-only effect channel is also provided for output of LFE (low frequency effect), or low bass effects that are independent of other channels. (This is called the "LFE channel".) This channel is counted as 0.1, thus giving rise to the term 5.1 channels in total.

Compared to Dolby Surround, which is referred to a "3/1" system (left front, center, right front and just one surround channel), Dolby Digital features two surround channels, called stereo or split surrounds, each offering the same full-range fidelity as the three front channels.

By using the built-in Dolby Digital decoder, you can experience the dramatic realism and impact of Dolby Digital theater sound in your home.

The wide dynamic range of sound reproduced by the five full-range channels and precise sound orientation by digital sound processing provides listeners with excitement and realism that have never been experienced before.

Dolby Digital forms 5.1 channels as already mentioned, but it can also form fewer channels, for example 2-channel stereo and monaural. You may be able to find some 2-channel stereo and/or monaural sources encoded with Dolby Digital in the market.

Laser disc and DVD are home audio/video program sources that could benefit from Dolby Digital. In the near future, Dolby Digital will also be applied to DBS, CATV and HDTV. The ongoing release of Dolby Digital theatrical films now underway will provide an immediate source of Dolby Digital encoded video software.



Manufactured under license from Dolby Laboratories. "Dolby", "Pro Logic" and the double-D symbol are trademarks of Dolby Laboratories.

## DTS Digital Surround

---

DTS (Digital Theater Systems) was developed to replace analog soundtracks of movies with six discrete channels of digital soundtracks, and it is now installed in many theaters around the world. The DTS digital playback system changed the way we experienced movies in theaters with six discrete channels of superb digital audio.

DTS technology, through intense research and development has made it possible to deliver similar encode/decode discrete technology to home audio surround-sound entertainment. DTS Digital Surround is an encode/decode system which delivers six channels of master-quality, 20-bit audio; technically, it is 5.1 channels, which means 5 full-range (left, center, right and two surround) channels, plus a subwoofer (LFE) channel (as "0.1"). It is compatible with the 5.1 speaker configurations that are currently available for home theater systems.

The DTS Digital Surround algorithm is designed to encode the six channels of 20-bit audio on to some laser discs, compact discs and DVDs with considerably less data compression.

By using the DTS decoder built into this unit, you can experience the dramatic realism and impact of the DTS-installed theater's high quality sound in your home.

Laser disc, compact disc and DVD are home audio formats by which DTS can present its high-quality multi-channel audio. (In addition to movies on laser discs, many exciting new multi-channel music recordings will also become available in the form of DTS-encoded compact discs.)



Manufactured under license from Digital Theater Systems, Inc. US Pat. No. 5,451,942 and other world-wide patents issued and pending. "DTS", "DTS Digital Surround", are trademarks of Digital Theater Systems, Inc. Copyright 1996 Digital Theater Systems, Inc. All Rights Reserved.

## CINEMA DSP: Dolby Surround + DSP / DTS + DSP

The Dolby Surround sound and DTS systems show their full ability in a large movie theater, because movie sounds are originally designed to be reproduced in a large movie theater that uses a multitude of speakers. Trying to create a sound environment similar to that of a movie theater in your home is difficult because of the room size, material inside the walls, the number of speakers, and so on. In other words, your listening room is very different from a movie theater.

However, YAMAHA DSP technology allows you to create nearly the same sound experience as that of a large movie theater in your home by compensating for the lack of presence and dynamics in the listening room with original digital sound fields combined with Dolby Surround or DTS Digital Surround sounds.

### CINEMA DSP

The YAMAHA "CINEMA DSP" logo indicates those programs that are created by the combination of YAMAHA DSP technology and Dolby Surround or DTS.

#### Dolby Pro Logic + 2 Digital Sound Fields

Digital sound fields are created on the presence side and the rear surround side of the Dolby Pro Logic-decoded sound field, respectively. They create a wide acoustic environment and emphasize the surround effect in the room, letting you feel as much presence as if you were watching a movie in a popular Dolby Stereo theater.

Refer to pages 28 to 29 for the DSP program.

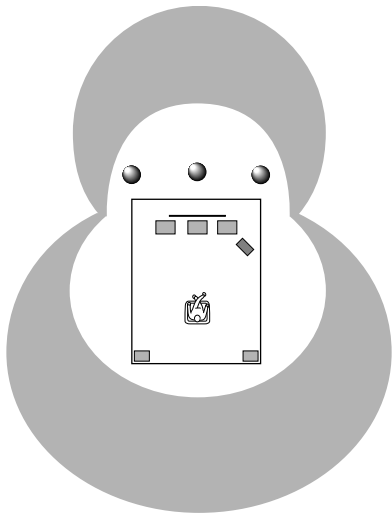

#### Dolby Digital or DTS + 3 Digital Sound Fields

Digital sound fields are created on the presence side and the independent left and right surround sides of the Dolby Digital-decoded or DTS-decoded sound field, respectively. They create a wide acoustic environment and strong surround effect in the room without losing high-channel separation. With the wide dynamic range of Dolby Digital or DTS sound, this sound field combination lets you feel as if you were watching a movie in the newest Dolby Digital theater or DTS-installed theater. This is the most ideal home theater sound at the present time.

Refer to pages 28 to 29 for the DSP program.

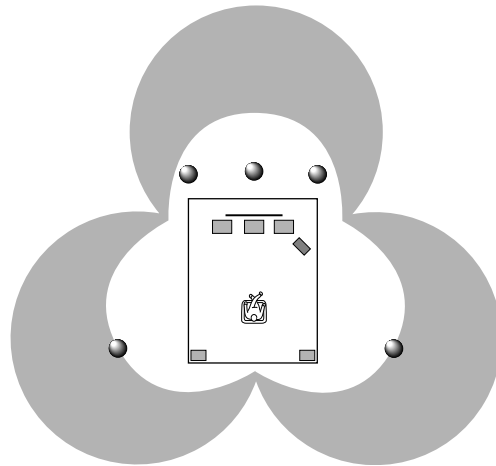

# CONTROLS AND THEIR FUNCTIONS

## FRONT PANEL

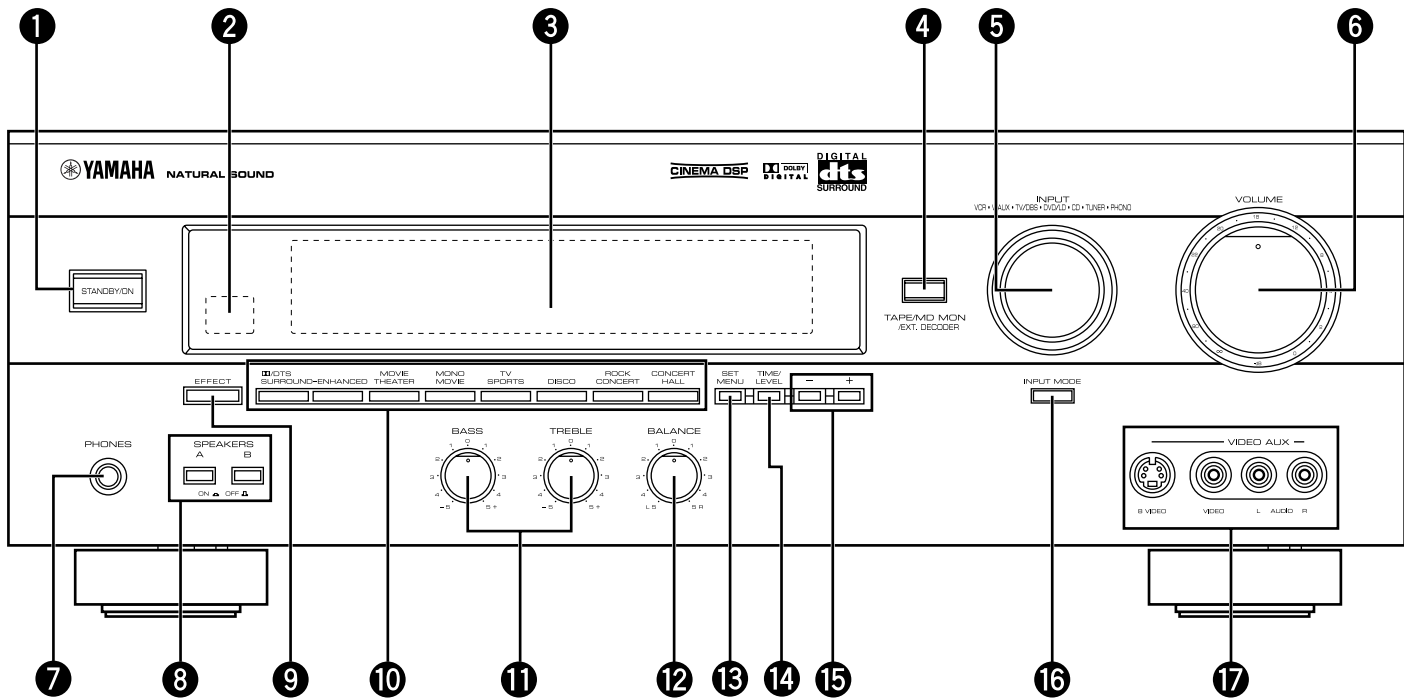

Refer to pages 35 to 40 for the remote control.

### 1 STANDBY/ON

Press this switch to turn on the power of this unit. Press it again to set this unit in the standby mode.

#### Standby mode

In this state, this unit consumes a very small quantity of power to receive infrared-signals from the remote control.

### 2 Remote control sensor

This receives signals from the remote control.

### 3 Display

This shows various information. (Refer to page 10 for details.)

### 4 TAPE/MD MON / EXT. DECODER

Press this button to play a tape or an MD. The "TAPE/MD MON" indicator lights up on the display. When you press the button next, the "TAPE/MD MON" indicator goes off, "EXT. DECDR" appears on the display and you can play the signal connected to the **EXTERNAL DECODER INPUT** terminals.

### 5 INPUT

Turn this selector to select the input source (VCR, VIDEO AUX, TV/DBS, DVD/LD, CD, TUNER, PHONO) that you want to listen to or watch.

The name of the selected input source appears on the display.

### 6 VOLUME

This control is used to raise or lower the volume level.

### 7 PHONES jack

When you use headphones, connect the headphones to the **PHONES** jack. You can listen to the sound to be output from the main speakers through the headphones.

When using headphones only, set both **SPEAKERS A** and **B** to the OFF position and switch off the digital sound field processor (so that no DSP program name appears on the display) by pressing **EFFECT**.



## 8 SPEAKERS

Set **A** or **B** (or both **A** and **B**) to the ON position for the main speaker system (connected to this unit) that you want to use. Set the button(s) for the main speaker system you don't want to use to the OFF position.

## 9 EFFECT

Press this button once to switch the effect speakers (center and rear) on or off. If you turn off the effect by using **EFFECT**, all Dolby Digital and DTS audio signals are directed to the main left and right channels. In that case, the left and right channel signal levels may not match.

## 10 PROGRAM selector

Press one of these buttons to select a DSP program. The name of the selected program appears on the display.

## 11 Tone controls

These controls are only effective for the sound from the main speakers.

### BASS

Use this control to increase or decrease the low-frequency response. The "0" position produces a flat response.

### TREBLE

Use this control to increase or decrease the high-frequency response. The "0" position produces a flat response.

## 12 BALANCE

This control is only effective for the sound from the main speakers.

Turn the control to adjust the balance of the output volume to the left and right speakers to compensate for sound imbalance caused by the speaker location or listening room conditions.

## 13 SET MENU

Press this button to select functions in the SET MENU mode.

## 14 TIME/LEVEL

Press this button to select the item in the TIME/LEVEL mode.

## 15 +/-

These buttons are used to adjust the settings of the SET MENU mode and the TIME/LEVEL mode. In the TIME/LEVEL mode, press **+** to increase the delay time or speaker output level. Press **-** to decrease the delay time or speaker output level.

## 16 INPUT MODE

This button switches between the DVD/LD and TV/DBS input signal modes.

## 17 VIDEO AUX terminals

Connect an auxiliary video or audio input source such as a camcorder to these terminals. If the connected video unit has an S video output terminal, connect it to the **S VIDEO** terminal to obtain a high-resolution picture. The source connected to these terminals can be selected by **INPUT**.

## DISPLAY PANEL

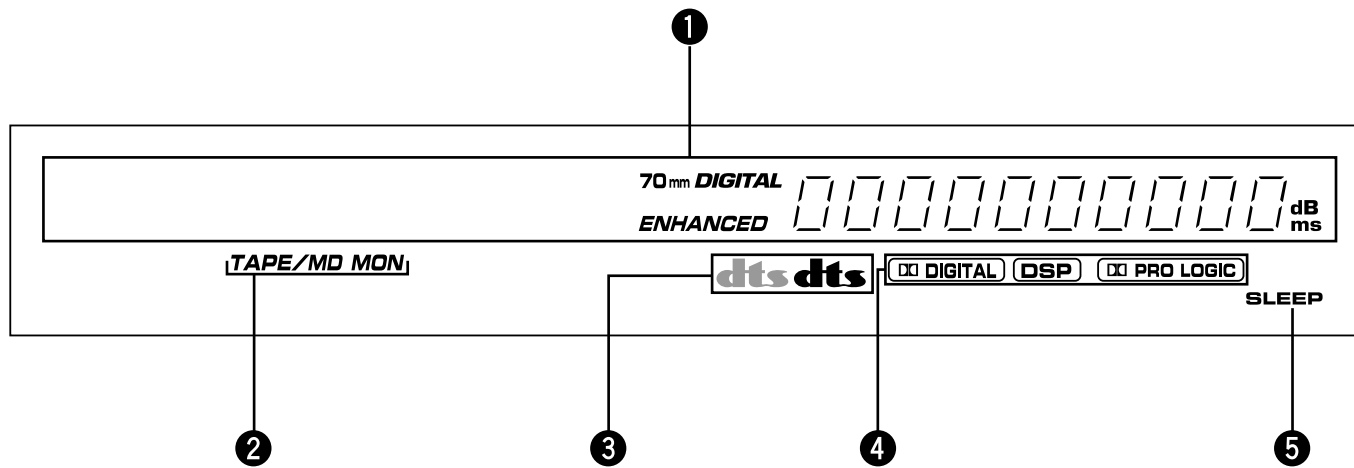

### 1 Multi-information display

This displays various information, for example the name of selected DSP program and name of selected input source.

### 2 TAPE/MD MON indicator

This lights up when the tape deck (or MD recorder, etc.) is selected as the input source by pressing **TAPE/MD MON / EXT. DECODER** on the front panel or **TAPE/MD** on the remote control.

### 3 dts indicators

Either "dts" indicator lights up when the built-in DTS decoder is turned on.

The red "dts" indicator lights up when playing a CD or LD encoded with DTS.

The orange "dts" indicator lights up when playing a DVD encoded with DTS.

\* An orange "dts" indicator may light up when playing a CD or LD encoded with DTS after playing a video-CD or DVD on a DVD/LD combi-player.

### 4 DIGITAL, DSP and PRO LOGIC indicators

"DIGITAL" lights up when the built-in Dolby Digital decoder is on and the signals of the selected source encoded with Dolby Digital are not in 2-channel. "DSP" lights up when the built-in digital sound field processor is on, and "PRO LOGIC" lights up when the built-in Dolby Pro Logic decoder is on. Depending on the selected DSP program, both "DIGITAL" and "DSP", or both "DSP" and "PRO LOGIC" will light up.

### 5 SLEEP indicator

This lights up while the built-in SLEEP timer is functioning.

# SPEAKER SETUP

## SPEAKERS TO BE USED

This unit is designed to provide the best sound-field quality with a 5-speaker configuration, using main speakers, rear speakers and a center speaker.

The main speakers are used for the main source sound plus the effect sounds. They will probably be the speakers from your present stereo system. The rear speakers are used for the effect and surround sounds, and the center speaker is for the center sounds (dialog, vocals, etc.). If for some reason it is not practical to use a center speaker, you can do without it. Best results, however, are obtained with the full system.

The main speakers should be high-performance models and have enough power-handling capacity to accept the maximum output of your audio system.

The other speakers do not have to be equal to the main speakers. For precise sound localization, however, it is ideal to use high-performance models that can reproduce sounds over the full range for the center speaker and the rear speakers.

### Use of a subwoofer expands your sound field

It is also possible to further expand your system with the addition of a subwoofer. The use of a subwoofer is effective not only for reinforcing bass frequencies from any or all channels, but also for reproducing the LFE (low frequency effect) sound with high fidelity when playing back a source that is Dolby Digital or DTS-decoded. The YAMAHA Active Servo Processing Subwoofer System is ideal for natural and lively bass reproduction.

## SPEAKER PLACEMENT

Refer to the following diagram when you place the speakers.

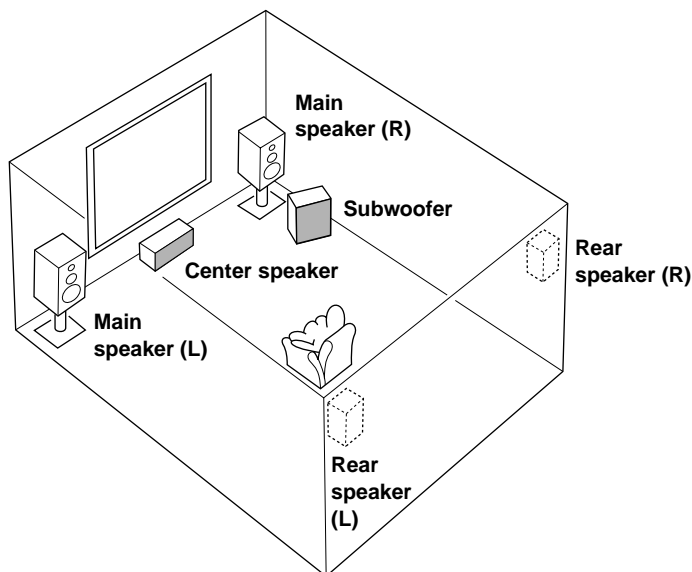

- Main:** The position of your present stereo speaker system.
- Rear:** Behind your listening position, facing slightly inward. Nearly 1.8 m (approx. 6 feet) up from the floor.
- Center:** Precisely between the main speakers. (To avoid interference with TV sets, use a magnetically shielded speaker.)
- Subwoofer:** The position of the subwoofer is not as critical, because low bass tones are not highly directional.

**Note:** If the center speaker (principally, it reproduces dialog, vocals, etc.) is not used, the sound will be output from the left and right main speakers. In that case, be sure to select the NONE position for "CNTR" in the SET MENU mode. (See page 18 for details.)

# CONNECTIONS

Never plug in this unit and other components until all connections have been completed.

## CONNECTIONS WITH OTHER COMPONENTS

Use RCA-type pin plug cables for connecting audio/video components with the exception described later.

When making connections between this unit and other components, be sure all connections are made correctly, that is to say L (left) to L, R (right) to R, “+” to “+” and “-” to “-”. Also, refer to the owner’s manual for each component to be connected to this unit.

\* If you have YAMAHA components numbered as 1, 2, 3, 4, etc. on the rear panel, connections can be made easily by making sure to connect the output (or input) terminals of each component to the same-numbered terminals of this unit.

### \*<sup>1</sup> AC OUTLET(S) (SWITCHED)

Europe model ..... 2 OUTLETS  
U.K. model ..... 1 OUTLET

Use these to connect the power cords from your components to this unit.

The power to the **AC OUTLET(S)** is controlled by this unit’s **STANDBY/ON** or the provided remote control’s **POWER** and **STANDBY**. These outlets will supply power to any connected component whenever this unit is turned on.

The maximum power (total power consumption of components) that can be connected to the **AC OUTLET(S)** is 100 watts.

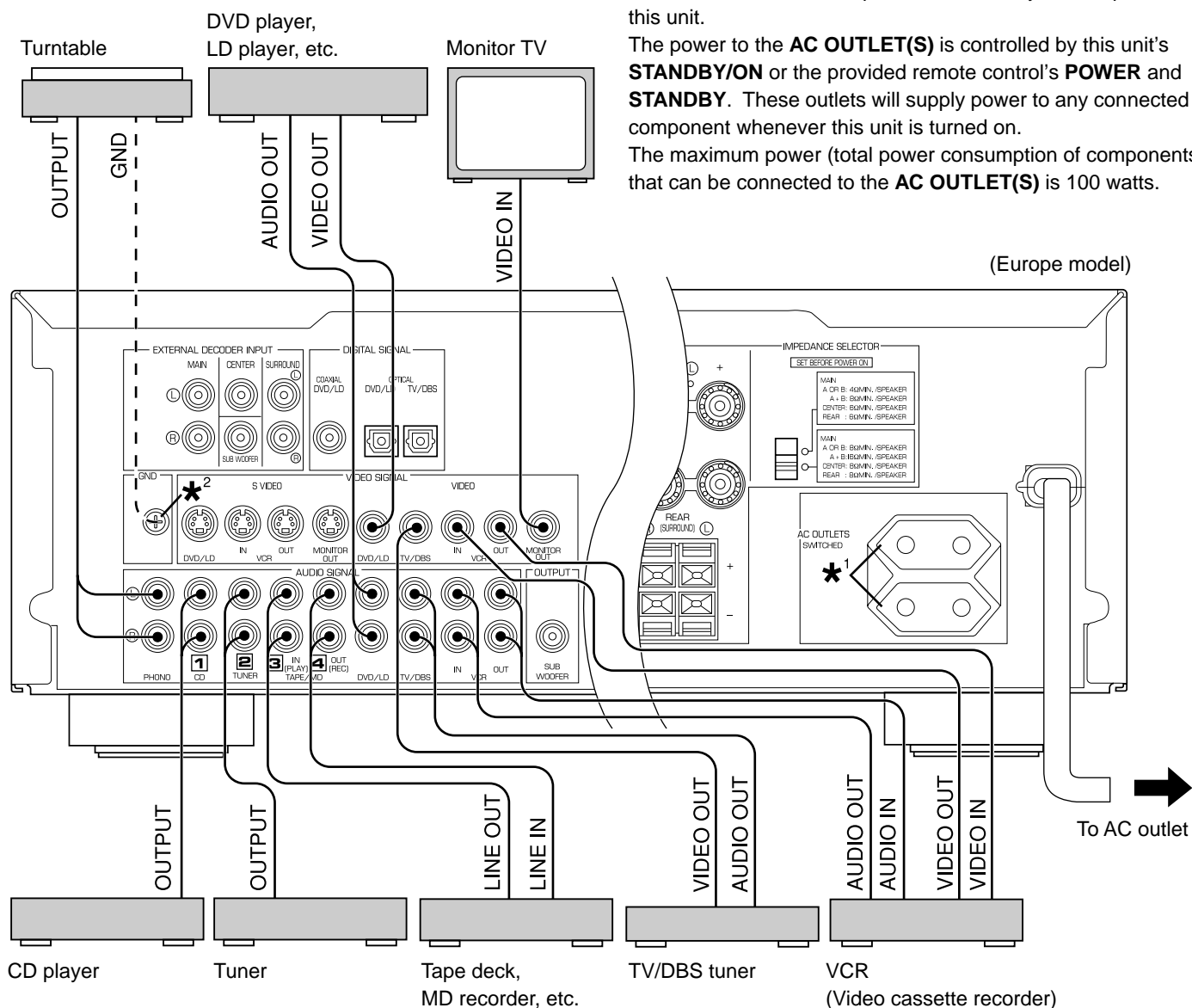

### \*<sup>2</sup> GND terminal (for turntable use)

Connecting the ground (earth) wire of the turntable to the **GND** terminal will normally minimize hum, but in some cases, better results may be obtained with the ground wire disconnected.

## CONNECTING TO DIGITAL (COAXIAL AND/OR OPTICAL) TERMINALS

If your DVD (LD) player, TV/DBS tuner, etc. are equipped with coaxial or optical digital audio signal output terminals, they can be connected to this unit's **COAXIAL** and/or **OPTICAL** digital signal input terminals.

Digital audio signals are transmitted with less loss than analog audio signals. In addition, digital audio signal connections are necessary, especially for an LD player or a DVD player, to send signals encoded with Dolby Digital or DTS to this unit.

To make a connection between optical digital audio signal terminals, remove the cover from each terminal, and then connect them by using a commercially available optical fiber cable that conforms to EIAJ standards. Other cables might not function correctly.

Even if you connect an audio/video unit to the **COAXIAL** (or **OPTICAL**) terminal of this unit, you must keep the unit connected with the same-named analog audio signal terminals of this unit, because a digital signal cannot be recorded by a tape deck, MD recorder or VCR connected to this unit. You can easily switch the selection of input signals between "digital" and "analog." (See page 25 for details.)

### Notes

- When connecting an audio/video unit to both the digital and analog terminals of this unit, make sure to connect between both terminals of the same name.
- Be sure to attach the covers when the **OPTICAL** terminals are not being used in order to protect them from dust.
- The input signal from the DVD/LD input terminals is selected in the following order of priority with the input mode set to the AUTO position:
  - 1 **COAXIAL** terminal
  - 2 **OPTICAL** terminal
  - 3 Analog terminal
- If the DIGITAL OUT data of the player has been processed in any way, you may not be able to perform DTS playback even if you make a digital connection between this unit and the player.
- All digital audio signal input terminals are applicable to sampling frequencies of 32 kHz, 44.1 kHz and 48 kHz.

No sound will be generated when connecting your LD player's Dolby Digital RF signal output terminal directly to this unit's **COAXIAL DVD/LD** digital signal input terminal.

DVD or LD player\*

\* If your LD player has a Dolby Digital RF signal output terminal, be sure to use the RF demodulator (separately purchased).

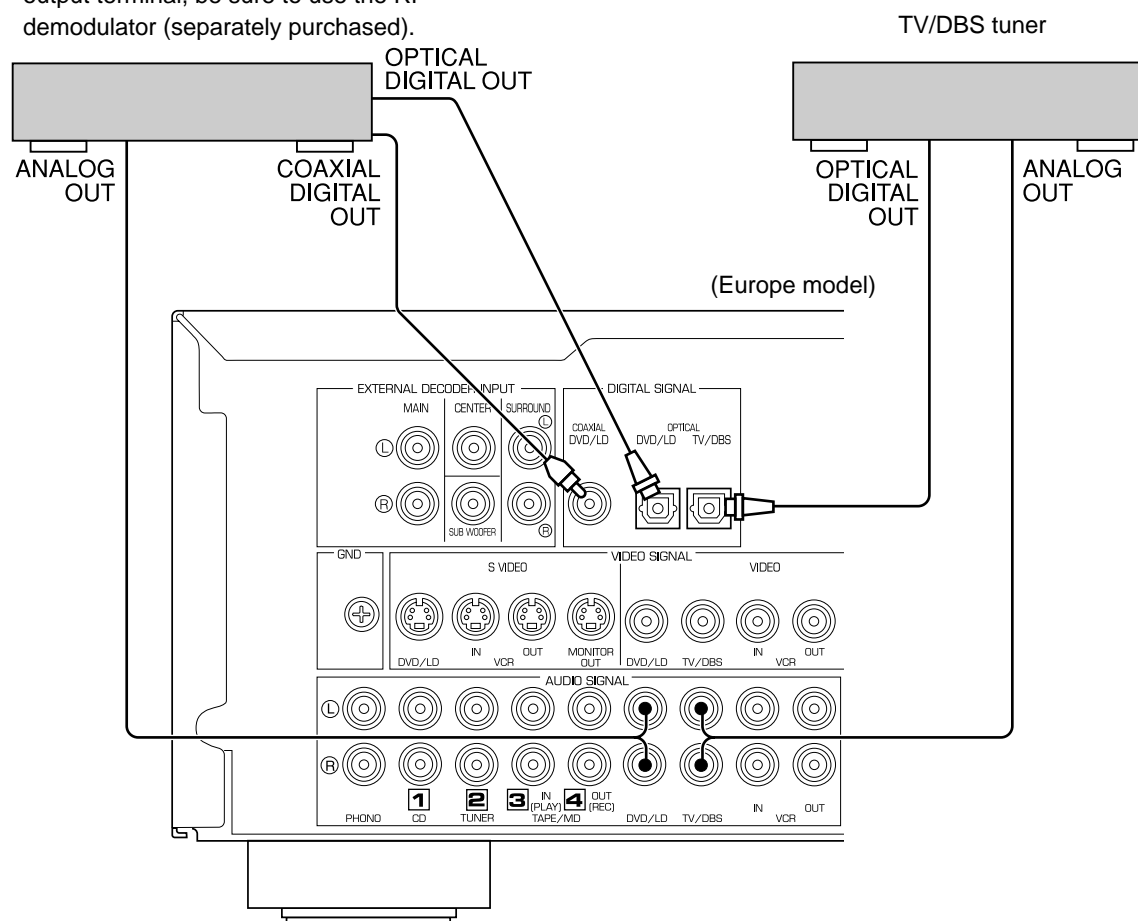

## CONNECTING TO S VIDEO TERMINALS

If you have a VCR and a monitor equipped with “S” (high-resolution) video terminals, those terminals can be connected to this unit’s **S VIDEO** terminals. Connect the VCR’s “S” video input and output terminals to this unit’s **S VIDEO VCR OUT** and **IN** terminals, respectively, and connect the monitor’s “S” video input terminal to this unit’s **S VIDEO MONITOR OUT** terminal. Otherwise, connect the VCR’s composite video terminals to this unit’s composite video terminals, and connect the monitor’s composite video input terminal to this unit’s composite **MONITOR OUT** terminal.

In addition, if you have a DVD or LD player equipped with an “S” video terminal, connect the DVD/LD player’s “S” video output terminal to this unit’s **S VIDEO DVD/LD** terminal.

### Note

If video signals are sent to both **S VIDEO** input and composite input terminals, the signals will be sent to their respective output terminals.

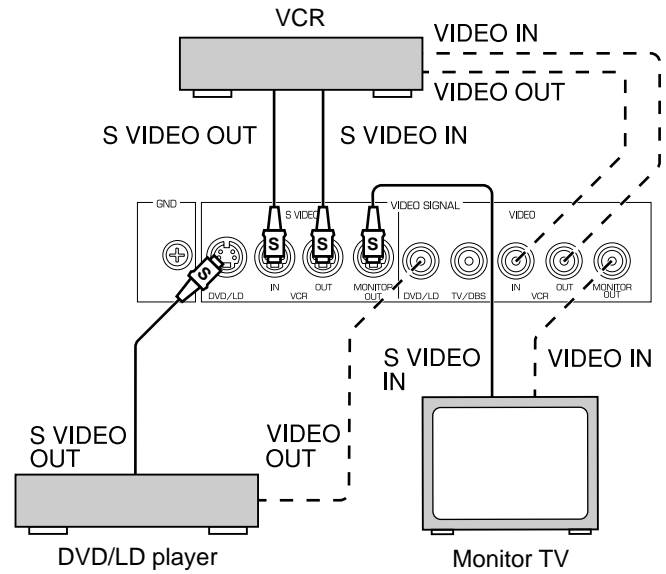

 S VIDEO cable

### S VIDEO terminals

This unit provides you with **S VIDEO** terminals in addition to standard VIDEO terminals.

**S VIDEO** terminals transmit video signals separated into luminance (Y) signals and color (C) signals. In comparison with **S VIDEO** terminals, standard VIDEO terminals transmit “composite” video signals.

## CONNECTING TO VIDEO AUX TERMINALS (ON THE FRONT PANEL)

These terminals are used to connect any video input source such as a camcorder to this unit.

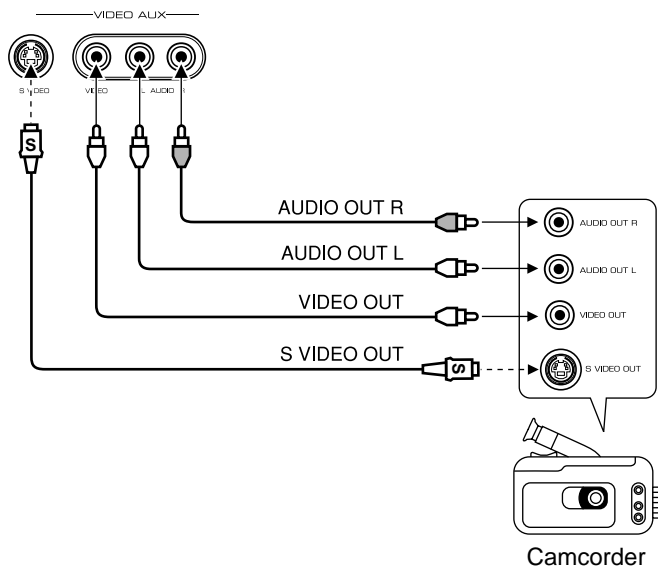

## CONNECTING WITH A MONITOR TV THAT USES A 21-PIN CONNECTOR FOR INPUT

Make a connection as shown below with a commercially available SCART-plug connector cable.

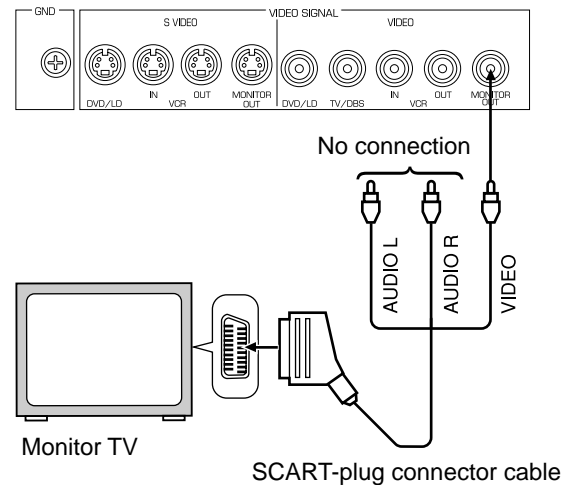

## CONNECTING TO AN EXTERNAL DECODER

This unit is equipped with additional 6-channel audio signal input terminals for inputting signals from an external decoder to this unit.

Connect the 6-channel audio signal output terminals of the decoder to the **EXTERNAL DECODER INPUT** terminals of this unit.

### Notes

- When signals input to these terminals are selected, the digital sound field processor cannot be used.
- The settings of “CNTR”, “REAR”, “MAIN” and “BASS” in the SET MENU mode have no effect on the signals input to these terminals. The setting of “M.LVL” is effective. (Refer to page 18 for details.)
- Adjustment of the output level of the center speakers, rear speakers and subwoofer is effective when the signals input to these terminals are selected as the input source. (Refer to page 31 for details.)

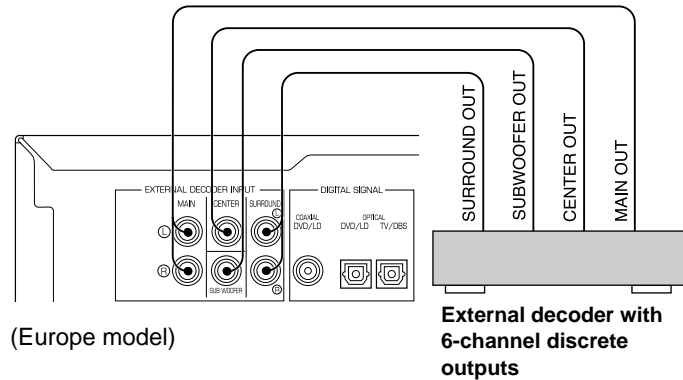

## IMPEDANCE SELECTOR SWITCH

### WARNING

Do not change the **IMPEDANCE SELECTOR** switch setting while the power to this unit is on, otherwise this unit may be damaged.

If this unit fails to turn on when the STANDBY/ON switch is pressed, the **IMPEDANCE SELECTOR** switch may not be fully set to either end. If so, set the switch to either end fully when this unit is in the standby mode.

### IMPEDANCE SELECTOR

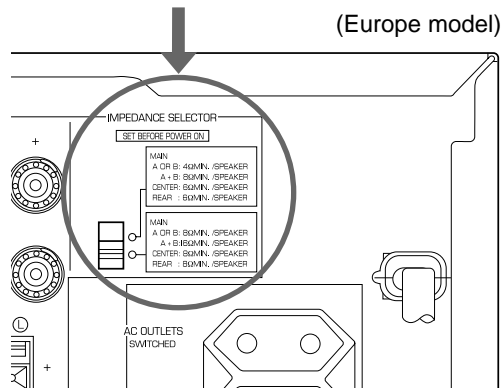

Select the position whose requirements your speaker system meets.

 (Upper position)

**Main:** If you use one pair of main speakers, the impedance of each speaker must be 4 Ω or higher.

If you use two pairs of main speakers, the impedance of each speaker must be 8 Ω or higher.

**Center:** The impedance of the speaker must be 6 Ω or higher.

**Rear:** The impedance of each speaker must be 6 Ω or higher.

 (Lower position)

**Main:** If you use one pair of main speakers, the impedance of each speaker must be 8 Ω or higher.

If you use two pairs of main speakers, the impedance of each speaker must be 16 Ω or higher.

**Center:** The impedance of the speaker must be 8 Ω or higher.

**Rear:** The impedance of each speaker must be 8 Ω or higher.

# CONNECTING SPEAKERS

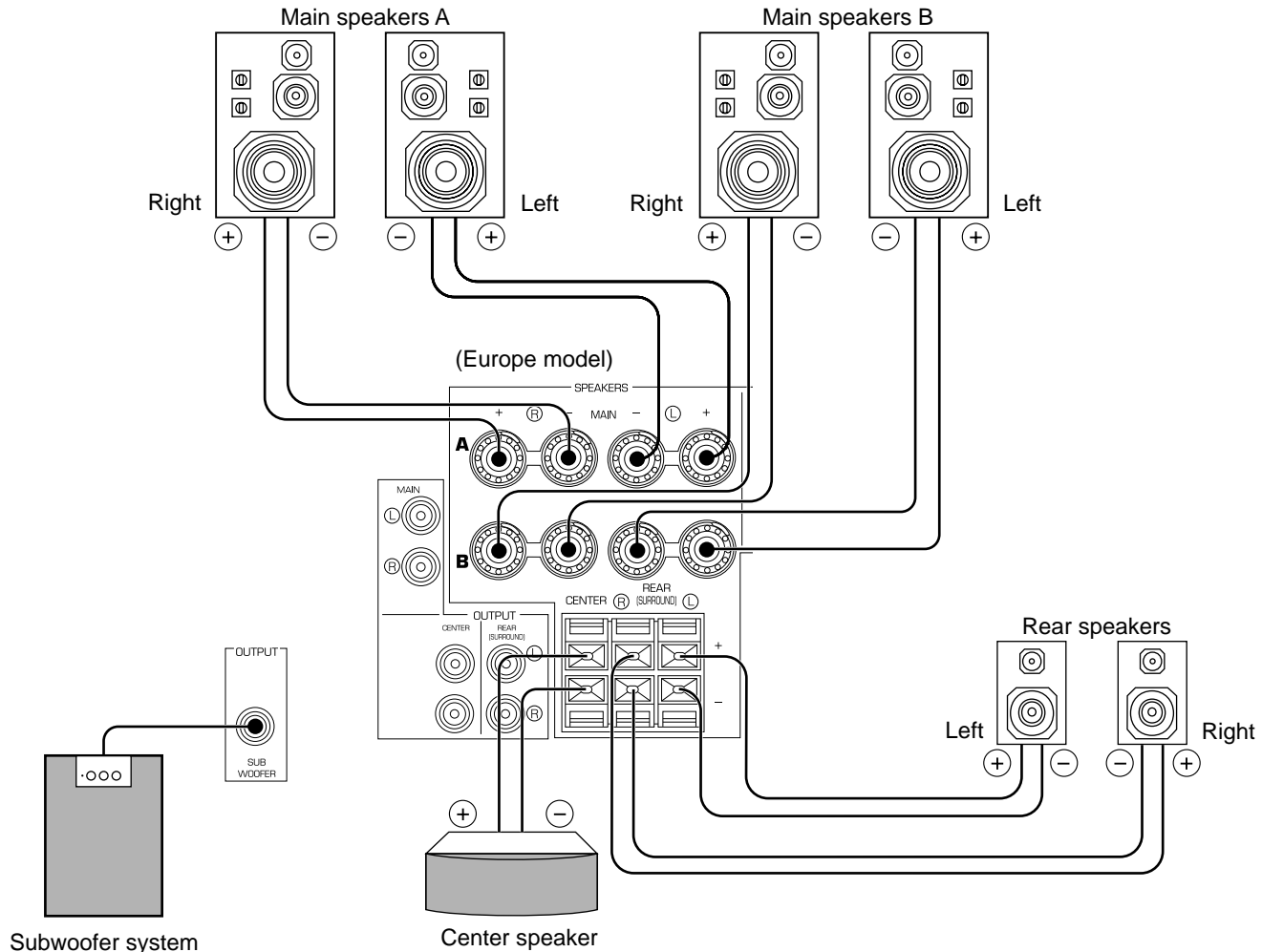

**Note**

Use speakers with the specified impedance shown on the rear panel of this unit.

**Main speaker connections**

One or two speaker systems can be connected to this unit. If you use only one speaker system, connect it to either of the **SPEAKERS A** or **B** terminals.

**Rear speaker connections**

A rear speaker system can be connected to this unit. Place them to the rear of your listening position.

**Center speaker connection**

A center speaker can be connected to this unit. Place it on or under the TV.

**Subwoofer connection**

You may wish to add a subwoofer to reinforce low frequencies or to output low bass sound from the subwoofer channel. If you have a subwoofer with built-in amplifier, including the YAMAHA Active Servo Processing Subwoofer System, connect the **SUBWOOFER OUTPUT** terminal of this unit to the input terminal of the subwoofer system.



## How to connect

Connect the **SPEAKERS** terminals to your speakers with wire of the proper gauge, cut as short as possible. If the connections are faulty, no sound will be heard from the speakers. Make sure that the polarity of the speaker wires is correct, that is the + and – markings are observed. If these wires are reversed, the sound will be unnatural and lack bass.

### Caution

**Do not let the bare speaker wires touch each other and do not let them touch any metal part of this unit. This could damage the unit and/or speakers.**

### Connecting to the MAIN SPEAKERS terminals

Red: positive (+)  
Black: negative (–)

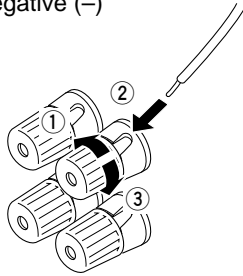

- ① Unscrew the knob.
- ② Remove approx. 5 mm (1/4") of insulation from each of the speaker wires and insert one bare wire into each terminal.
- ③ Tighten the knob to secure the wire.

### Connecting to the REAR and CENTER SPEAKERS terminals

Red: positive (+)  
Black: negative (–)

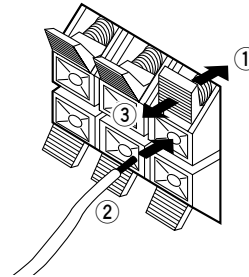

- ① Press the tab.
- ② Remove approx. 5 mm (1/4") of insulation from each of the speaker wires and insert one bare wire into each terminal.
- ③ Release the tab to secure the wire.

## OUTPUT TERMINALS (FOR DRIVING A SPEAKER WITH AN EXTERNAL AMPLIFIER)

The speaker connections described on page 16 are fine for most applications. If for some reason, however, you wish to drive main, center and/or rear speakers with your existing amplifier, etc., the following terminals are available for connecting an external amplifier(s) to this unit.

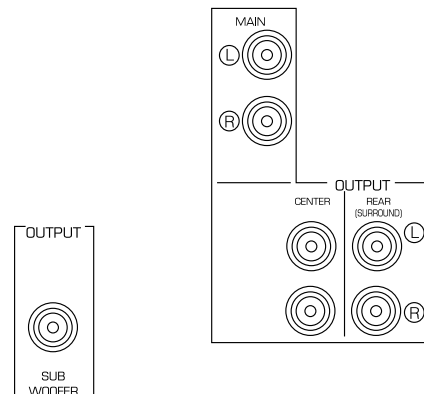

# ADJUSTMENTS BEFORE USING THIS UNIT

## SELECTING THE OUTPUT MODES

This unit provides you with the following five functions to determine the method of distributing output signals to speakers suitable for your audio system. When speaker connections have all been completed, select the proper setting for each function to make the best use of your speaker system. (See "ADJUSTMENTS IN THE 'SET MENU' MODE" on page 33.)

1. CNTR (CENTER SPEAKER)
2. REAR (REAR SPEAKERS)
3. MAIN (MAIN SPEAKERS)
4. BASS (LFE/BASS OUT)
5. M.LVL (MAIN LEVEL)

### DESCRIPTION OF EACH FUNCTION

#### CNTR (CENTER SPEAKER)

Choices: LARGE/SMALL/NONE

Preset position: LARGE

- LARGE:** Select this position when your center speaker is approximately the same size as the main speakers.
- SMALL:** Select this position when you use a center speaker that is smaller than the main speakers.  
In this position, low bass signals (below 90 Hz) on the center channel are output from the main speakers (or the **SUBWOOFER OUTPUT** terminal if the SMALL position is selected for "MAIN" and the SW position is selected for "BASS").
- NONE:** Select this position when you do not have a center speaker (four speaker system). The center channel sound will be output from the left and right main speakers.

#### REAR (REAR SPEAKERS)

Choices: LARGE/SMALL

Preset position: LARGE

- LARGE:** Select this position if your rear speakers have high ability for bass reproduction, or if a subwoofer is connected in parallel to the rear speaker.  
In this position, full-range signals are output from the rear speakers.
- SMALL:** Select this position if your rear speakers do not have high ability for bass reproduction.  
In this position, low bass signals (below 90 Hz) on the rear channels are output from the **SUBWOOFER OUTPUT** terminal (or the main speakers if the MAIN position is selected for "BASS").

#### MAIN (MAIN SPEAKERS)

Choices: LARGE/SMALL

Preset position: LARGE

- LARGE:** Select this position if your main speakers have high ability for bass reproduction.  
In this position, full-range signals present on the main channels are output from the main speakers.
- SMALL:** Select this position if your main speakers do not have high ability for bass reproduction. However, if your system does not include a subwoofer, do not select this position.  
In this position, low bass signals (below 90 Hz) on the main channels are output from the **SUBWOOFER OUTPUT** terminal if the SW or BOTH position is selected for "BASS".

#### BASS (LFE/BASS OUT)

Choices: SW/MAIN/BOTH

Preset position: SW

- MAIN:** Select this position if your system does not include a subwoofer.  
In this position, full-range signals present on the main channels, signals from the LFE channel and other low bass signals that are distributed from other channels are output from the main speakers.
- SW/BOTH:** Select either the SW or BOTH position if your system includes a subwoofer.  
In either position, signals on the LFE channel and other low bass signals that are distributed from other channels are output from the **SUBWOOFER OUTPUT** terminal.  
When the LARGE position is selected for "MAIN", in the SW position, no signal is distributed from the main channels to the **SUBWOOFER OUTPUT** terminal; however, in the BOTH position, low bass signals from the main channels are output to both the main speakers and the **SUBWOOFER OUTPUT** terminal.

#### M.LVL (MAIN LEVEL)

Choices: NRML (NORMAL)/-10 dB

Preset position: NRML (NORMAL)

- NRML (NORMAL):** Normally select this position.
- 10 dB:** Select this position if the sound output from the main speakers is too loud and cannot be balanced with the sound output from the center and rear speakers. In this position, the sound output from the main speakers is attenuated.

#### Note

The settings of "CNTR", "REAR", "MAIN" and "BASS" have no effect on the signals input to the **EXTERNAL DECODER INPUT** terminals on the rear of this unit.

## ADJUSTMENT METHOD

Adjustments should be made while watching the information on this unit's display.

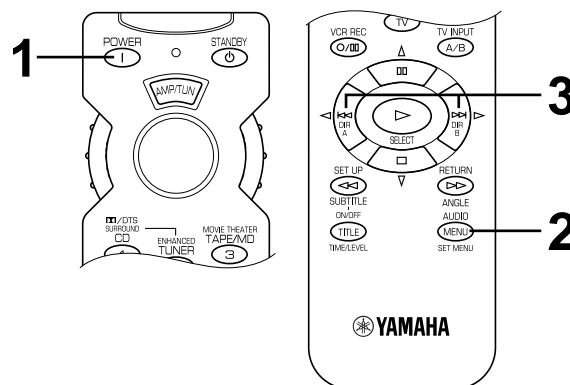
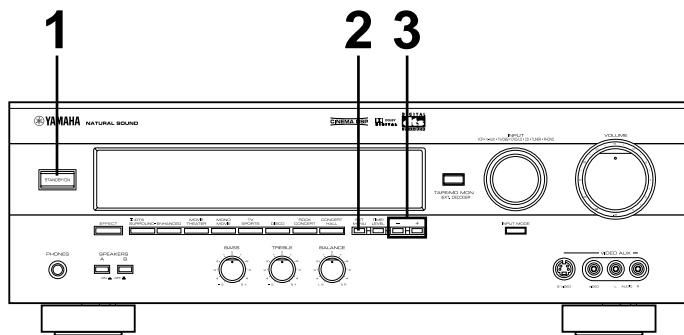

When adjusting with the remote control, set the SELECTOR DIAL to the AMP/TUN or DSP position on the remote control.

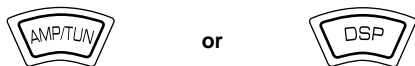

**1** Turn the power on.

Front panel

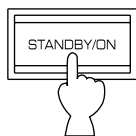

Remote control



**2** Press **SET MENU** once or more to select the function "CNTR" on the display.

Front panel



Remote control



\* After pressing **SET MENU** once on the remote control, you can also select the function by pressing  $\nabla$ . (Pressing  $\Delta$  goes back one selection.)



CNTR>LARGE

**3** Press **+** or **-** once or more to select the setting you want.

Front panel

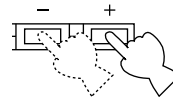

Remote control

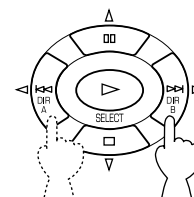

CNTR>SMALL

**4** Repeat steps 2 and 3 to change the settings for "REAR", "MAIN", "BASS" and/or "M.LVL" in the same way.

# SPEAKER BALANCE ADJUSTMENT

This procedure lets you adjust the sound output level balance between the main, center and rear speakers by using the built-in test tone generator. When this adjustment is performed, the sound output level heard at the listening position will be the same from each speaker. This is important for the best performance of the digital sound field processor, the Dolby Digital decoder, the Dolby Pro Logic decoder and the DTS decoder.

**The adjustment of each speaker output level should be done at your listening position with the remote control.**  
**After completing the adjustment of the output level for each speaker, use VOLUME ( ^ v ) on the remote control at your listening position to check if the adjustments are satisfactory.**

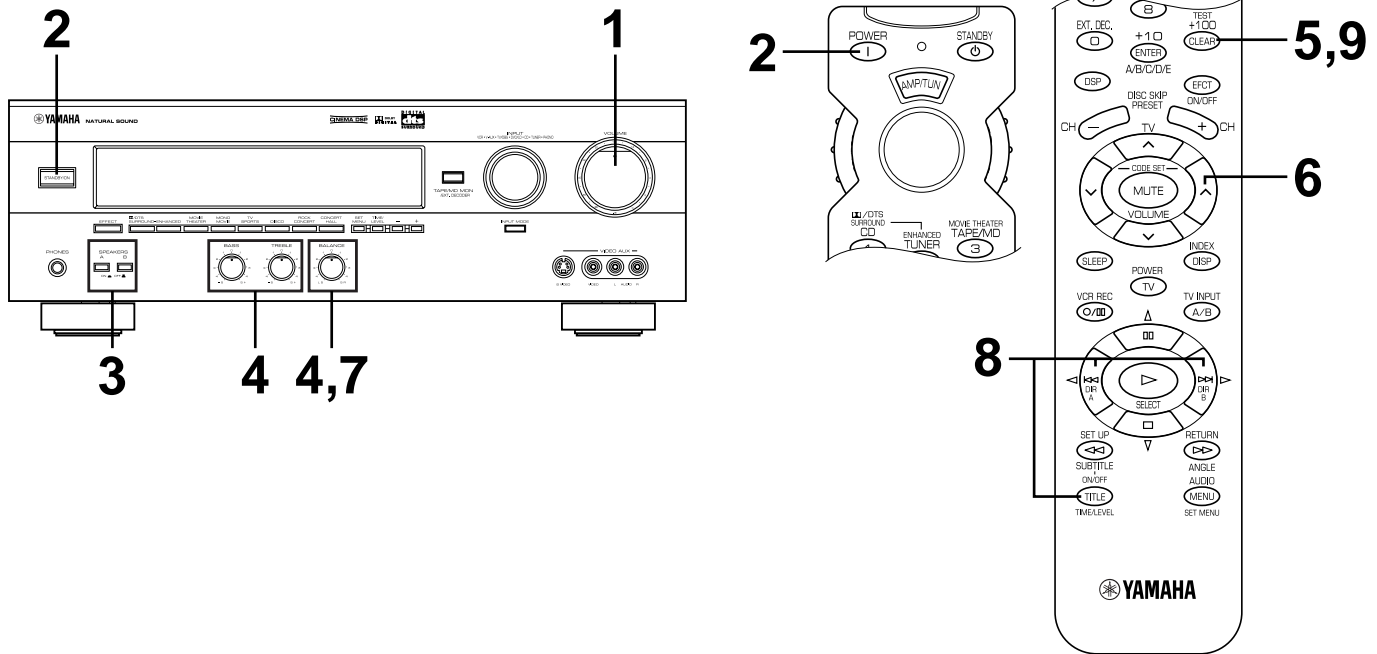

Set the SELECTOR DIAL to the AMP/TUN or DSP position on the remote control.

**2** Turn the power on.

**Front panel** **Remote control**

**1** Set **VOLUME** to the "∞" position.

**Front panel**

**3** Select the main speakers to be used.

**Front panel**

\* If you use two main speaker systems, press both **A** and **B**.

**4** Set **BASS**, **TREBLE** and **BALANCE** to the "0" position.

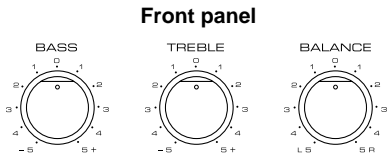

**5** Press **TEST** so that "TEST LEFT" appears on the display.

**Remote control**

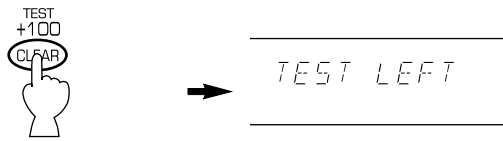

**6** Turn up the volume.

**Remote control**

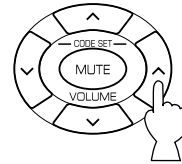

You will hear a test tone (like pink noise) from each speaker for about two seconds in following order: left main speaker, center speaker, right main speaker, right rear speaker and left rear speaker. The display changes as shown below.

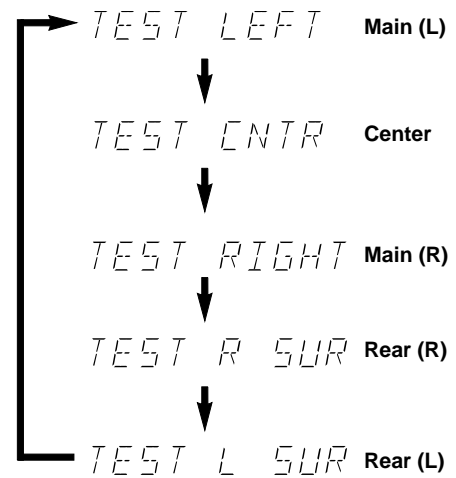

\* If the function "CNTR" in the SET MENU mode is set to the NONE position, you will hear the center channel test tone from the left and right main speakers.

**7** Adjust **BALANCE** so that the sound output level of the left main speaker and the right main speaker is the same.

**Front panel**

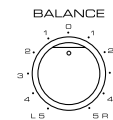

**8** Adjust the sound output levels of the center speaker and the rear speakers so that they become almost the same as that of the main speakers.

Press **TIME/LEVEL** once or more to select the speaker to be adjusted so that "CENTER", "R SUR." or "L SUR." appears on the display.

**Remote control**



\* You cannot adjust the delay time while the test tone is sounding even if "DELAY" appears on the display after pressing **TIME/LEVEL** once or more.

Adjust the level.

\* Pressing **▷** raises and **◁** lowers the level.

\* While adjusting, the test tone is heard from the selected speaker.

**Remote control**

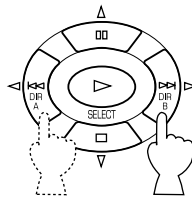

**9** When the adjustment is finished, press **TEST** again to stop the test tone.

**Remote control**



**Notes**

- Once you have completed these adjustments, you can only adjust the overall sound level of your audio system by using **VOLUME** (or **VOLUME** ( ^ v ) on the remote control).
- If you use external power amplifiers, you may also use their volume controls to achieve the proper balance.
- If the function "CNTR" in the SET MENU mode is set to the NONE position, the sound output level of the center speaker cannot be adjusted in step 8. The center sound is automatically output from the left and right main speakers.
- If there is insufficient sound output from the center and rear speakers, you may decrease the main speaker output level by setting "M.LVL" to "-10 dB".

# BASIC OPERATION

## TO PLAY A SOURCE

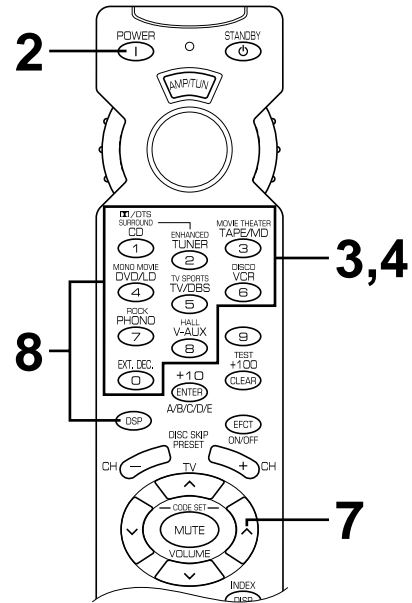
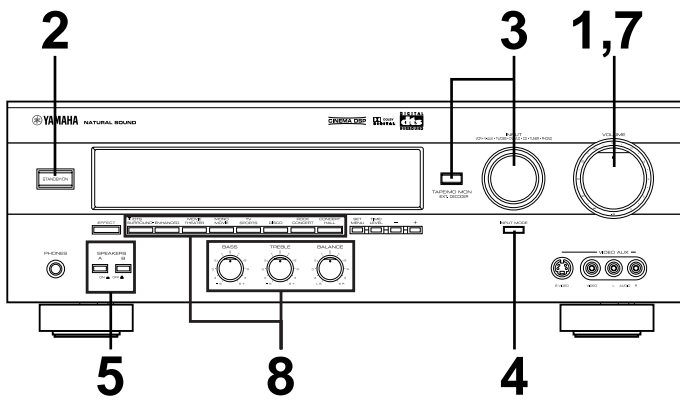

### When using the remote control

- Set the SELECTOR DIAL to the AMP/TUN position on the remote control.
- To operate the tuner, the CD player, DVD/LD player, tape deck, MD recorder, or other components with this remote control, set the SELECTOR DIAL to the component to be used. (See "SETUP CODES" on page 41.)

**1** Set **VOLUME** to the "∞" position.

#### Front panel

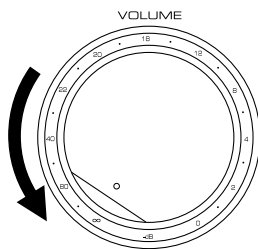

**2** Turn the power on.

#### Front panel



or

#### Remote control

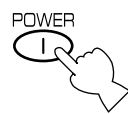

**3** Select the desired input source by using **INPUT**.  
(Turn on the monitor TV for video sources.)

#### Front panel

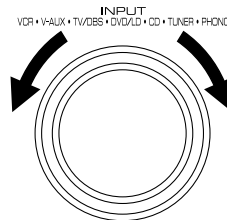

#### Remote control

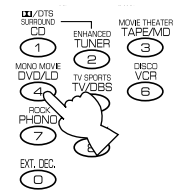

or

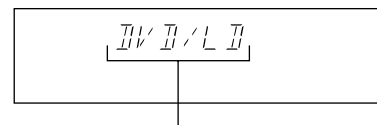

The name of the selected input source will appear on the display.

### To play a tape or an MD

Press **TAPE/MD MON / EXT. DECODER** on the front panel or **TAPE/MD** on the remote control so that the "TAPE/MD MON" indicator lights up on the display.

#### Front panel

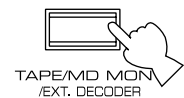

### To use a decoder connected to the EXTERNAL DECODER INPUT terminals

Press **TAPE/MD MON / EXT. DECODER** once or more on the front panel or **EXT. DEC.** on the remote control so that "EXT. DECDR" appears on the display.

- 4** For a DVD/LD or TV/DBS source, the current input mode is also shown.
- \* To change the input mode for the DVD/LD or TV/DBS source, press **INPUT MODE** (or the button that you have pressed to select the input source in step 3 on the remote control) once or more until the desired input mode is shown on the display. (See page 25 for details on switching the input mode.)

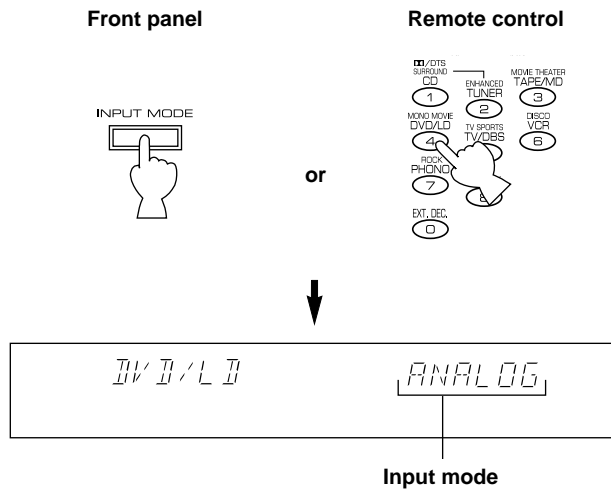

- 5** Select the main speakers to be used.

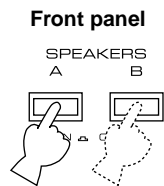

\* If you use two main speaker systems, press both **A** and **B**.

- 6** Play the source.

- 7** Adjust the volume to the desired output level.

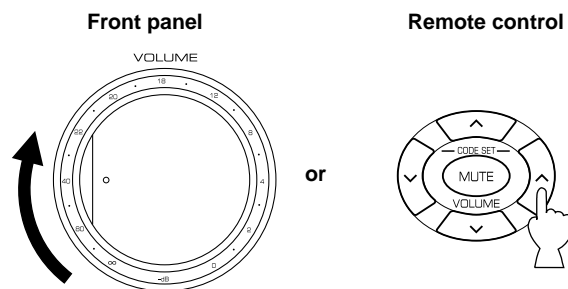

- 8** If desired, adjust **BASS**, **TREBLE**, **BALANCE**, etc. and use the digital sound field processor (see pages 28 to 29).

**BASS:** Turn this control clockwise to increase (or counterclockwise to decrease) the low-frequency response.

**TREBLE:** Turn this control clockwise to increase (or counterclockwise to decrease) the high-frequency response.

**BALANCE:** Adjust the balance of the output volume from the left and right speakers to compensate for any sound imbalance caused by the speaker location or listening room conditions.

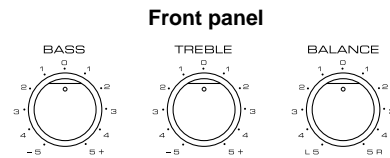

\* These controls are only effective for the sound from the main speakers.

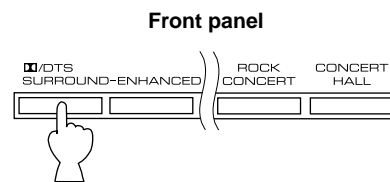

or  
**Remote control**

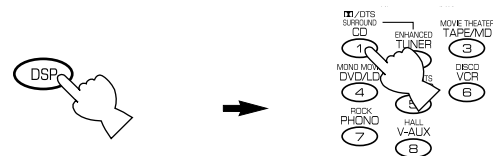

### When you have finished using this unit

Press **STANDBY/ON** on the front panel again or **STANDBY** on the remote control to set this unit in the standby mode.



## Notes on using INPUT

- The audio source selected by **INPUT** will not be played if the "TAPE/MD MON" indicator lights up or if "EXT. DECDR" is displayed.
- If you select a video source by **INPUT** without canceling the selection of **TAPE/MD MON / EXT. DECODER** on the front panel (or **TAPE/MD** or **EXT. DEC.** on the remote control), the play back result will be a video image from the video source and the sound from the audio source selected by **TAPE/MD MON / EXT. DECODER** on the front panel (or **TAPE/MD** or **EXT. DEC.** on the remote control).
- If an audio source is selected by **INPUT** while watching a video source, the selected audio source will be played, but the video image will not be interrupted.
- When you select an input source by **INPUT**, the DSP program (or no DSP program) that was being used when the same input source was selected the last time will be automatically recalled.
- If "DATA ERR" appears on the display while playing a CD or LD encoded with DTS, stop playback and turn the player off and then on again.

## Switching the input mode (for DVD/LD and TV/DBS)

This unit allows you to switch the input mode for sources that send two or more types of signal to this unit. The following three input modes are provided.

### AUTO

This mode is automatically selected when you turn on the power of this unit.

In this mode, the input signal is automatically selected in the following order of priority:

1. Digital signal encoded with Dolby Digital or DTS, or normal digital input signal (PCM)
2. Analog input signal (ANALOG)

\* For a DVD/LD source, if digital signals are input from both the **OPTICAL** and **COAXIAL** terminals, the digital signal from the **COAXIAL** terminal is selected.

### DTS

In this mode, only a digital input signal encoded with DTS is selected, even though other signals are input at the same time.

### ANALOG

In this mode, only an analog input signal is selected, even though digital signals are input at the same time.

Select this mode when you want to use an analog input signal instead of digital input signals.

## Notes on input mode selection

- The input mode for a TV/DBS source is selected with the function "INPUT" in the SET MENU mode. (See page 34 for details.)
- Set the input mode to AUTO to play a DVD/LD source encoded with Dolby Digital.
- Set the input mode to ANALOG to play a normal 2-channel source with a Dolby Surround program.
- The sound output may be interrupted in some LD and DVD players in the following situation:  
The input mode is set to AUTO. A search is made while playing the disc encoded with Dolby Digital or DTS, and then disc playing is restored. The sound output is interrupted for a moment because the digital input signal was selected again.
- The input mode cannot be changed for the PHONO, TUNER, TAPE/MD, CD, VCR and VIDEO AUX sources because only analog signals are used.
- The present input mode appears on the display when the input source is changed to DVD/LD or TV/DBS, or the input mode is changed.

### Notes on playing a source encoded with DTS

If you play a CD or LD encoded with DTS while the AUTO mode is selected, there will be a short noise at first while the unit identifies the DTS signal and activates the DTS decoder. This is not a malfunction, and can be avoided by setting the input mode to DTS beforehand. In addition, If you continue to play a CD or LD encoded with DTS with the input mode setting left at AUTO, this unit automatically switches to the "DTS-decoding" mode to prevent noise from being generated during future operation. (The red "dts" indicator lights up on the display.)

No sound will be heard if a normal PCM CD or LD is played in this mode. (The red "dts" indicator will flash.) To play a normal disk, return the input mode from DTS to AUTO.

# TO RECORD A SOURCE ON TAPE, MD OR VIDEO CASSETTE

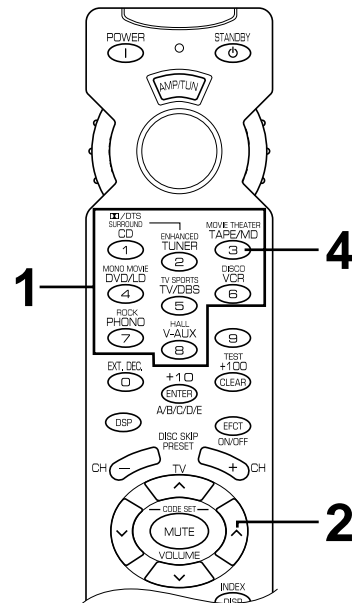
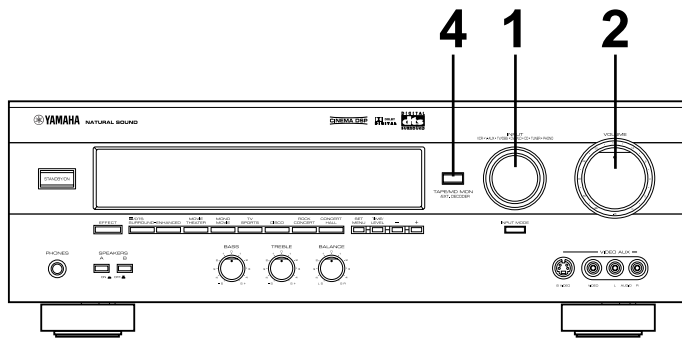

**1** Select the source to be recorded.

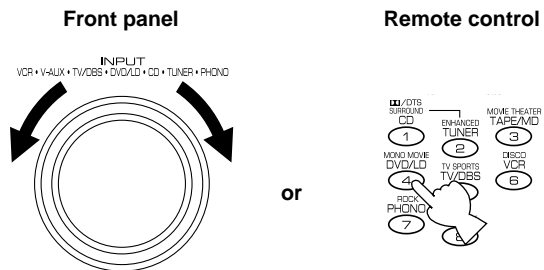

**4** When a tape deck or MD recorder is being used for recording, you can monitor the sounds being recorded by pressing **TAPE/MD MON / EXT. DECODER** on the front panel or **TAPE/MD** on the remote control so that the "TAPE/MD MON" indicator lights up on the display.

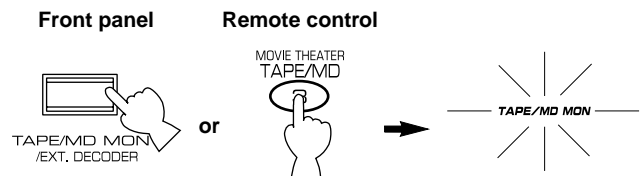

**2** Play the source and then turn up the volume to confirm the input source.

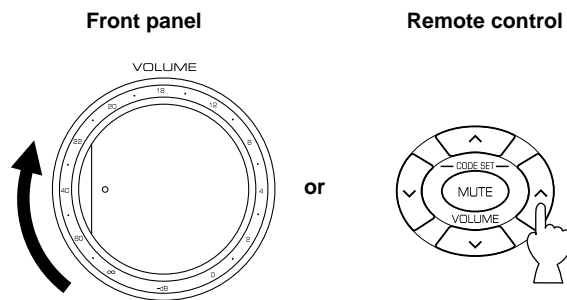

**3** Begin recording on the tape deck, MD recorder or VCR connected to this unit.

## Notes

- The settings of DSP and **VOLUME**, **BASS**, **TREBLE** and **BALANCE** have no effect on the material being recorded.
- Composite video and S video signals pass independently through this unit's video circuits. Therefore, when recording or dubbing video signals, if your video source unit is connected to provide only an S video (or only a composite video) signal, you can record only an S video (or only a composite video) signal on your VCR.
- A source that is connected to this unit only through the digital terminals cannot be recorded on a tape deck, MD recorder or VCR connected to this unit.
- A source of signals input to the **EXTERNAL DECODER INPUT** terminals of this unit cannot be recorded.
- Please check the copyright laws in your country to record from records, compact discs, radio, etc. Recording of copyright material may infringe copyright laws.

If you watch video software that uses scrambled or encoded signals to prevent it from being dubbed, there may be a case that the picture itself will be affected by those signals.

# SETTING THE SLEEP TIMER

The SLEEP timer can be used to make this unit automatically switch to the standby mode. When you are going to sleep while enjoying a broadcast or other desired input source, this timer function is useful. The SLEEP timer can only be controlled with the remote control.

**Notes**

- To set the SLEEP timer for this unit, set the SELECTOR DIAL to a position other than the TV position. To set the SLEEP timer for your TV, set the SELECTOR DIAL to the TV position.
- The components for which the SLEEP timer is effective are the sources connected to the **AC OUTLET(S)** on the rear panel of this unit.

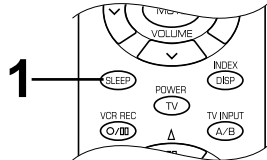

**To set the SLEEP time**

**1** Play the source which you want to enjoy when you are going to sleep and press **SLEEP** once or more to select the desired SLEEP time.

**Remote control**

↓

**The SLEEP time is displayed.**

**Flashes**

Each time you press **SLEEP**, the SLEEP time will change as follows:

(Minutes)

120 → 90 → 60 → 30

The SLEEP timer is off (SLEEP OFF).  
(This is the state before SLEEP is pressed.)

The "SLEEP" indicator soon lights up and the display returns to the indication before the SLEEP timer was set.

**2** The unit will be switched to the standby mode automatically at the selected SLEEP time.

**To cancel the selected SLEEP time**

**Remote control**



Press **SLEEP** once or more so that "SLEEP OFF" appears on the display. (It will soon disappear and the "SLEEP" indicator will go off from the display.)

**Note**

The SLEEP timer setting can also be canceled by setting the unit in the standby mode with **STANDBY/ON** on the front panel (or **STANDBY** on the remote control) or by disconnecting the power plug of the unit from the AC outlet.







# SOUND FIELD PROGRAM





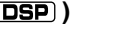

This unit incorporates a sophisticated, multi-program digital sound field processor. This processor allows you to electronically expand and change the shape of the audio sound field from both audio and video sources, creating a theater-like experience in your listening room. You can create outstanding audio sound by selecting a suitable sound field program (this will, of course, depend on what you are listening to) and adding any desired adjustments.

The operation of built-in decoders (Dolby Pro Logic, Dolby Digital and DTS) can be controlled by selecting a corresponding DSP program incorporating the combined operation of YAMAHA DSP and Dolby Surround, Dolby Digital or DTS.

The following list gives you a brief description of the sound fields produced by each of the DSP programs. Keep in mind that most of these are precise digital re-creations of actual acoustic environments.

## For movie or audio/video sources

No.	PROGRAM	FEATURES
1	<p><b>Normal Program</b></p> <p><b>[1] DOLBY PRO LOGIC (  )</b></p> <ul style="list-style-type: none"> <li>• Input source : Dolby Surround 2-ch Dolby Digital</li> <li>• Output channel : 4 channels</li> <li>• DSP : —</li> </ul> <p><b>[2] DOLBY DIGITAL (  )</b></p> <ul style="list-style-type: none"> <li>• Input source : Dolby Digital</li> <li>• Output channel : 5.1 channels</li> <li>• DSP : —</li> </ul> <p><b>[3] DTS (  )</b></p> <ul style="list-style-type: none"> <li>• Input source : DTS</li> <li>• Output channel : 5.1 channels</li> <li>• DSP : —</li> </ul>	<p>The built-in Dolby Pro Logic, Dolby Digital or DTS decoder precisely reproduces the sound and effect of the encoded source.</p> <p>The realization of a highly efficient decoding process improves cross talk and channel separation and makes sound positioning smoother and more precise.</p>
2	<p><b>Enhanced Program</b></p> <p><b>[1] DOLBY PRO LOGIC/Enhanced (  )</b></p> <ul style="list-style-type: none"> <li>• Input source : Dolby Surround 2-ch Dolby Digital</li> <li>• Output channel : 4 channels</li> <li>• DSP : 1 (surround)</li> </ul> <p><b>[2] DOLBY DIGITAL/Enhanced (  )</b></p> <ul style="list-style-type: none"> <li>• Input source : Dolby Digital</li> <li>• Output channel : 5.1 channels</li> <li>• DSP : 2 (surround L, R)</li> </ul> <p><b>[3] DTS/Enhanced (  )</b></p> <ul style="list-style-type: none"> <li>• Input source : DTS</li> <li>• Output channel : 5.1 channels</li> <li>• DSP : 2 (surround L, R)</li> </ul>	<p>This program ideally simulates the multi-surround speaker systems of the 35 mm-film movie theater. Each decoding and digital sound field processing operation is precisely performed without altering the original sound orientation.</p> <p>The surround effect produced by the sound field folds around the viewer naturally from the rear to the left and right and toward the screen.</p>

No.	PROGRAM	FEATURES
3	<p><b>CINEMA DSP Program</b></p> <p><b>[1] 70 mm MOVIE THEATER (   )</b></p> <ul style="list-style-type: none"> <li>• Input source : Dolby Surround 2-ch Dolby Digital</li> <li>• Output channel : 3 channels</li> <li>• DSP : 2 (presence &amp; surround)</li> </ul> <p><b>[2] 70 mm MOVIE THEATER – DOLBY D. (   )</b></p> <ul style="list-style-type: none"> <li>• Input source : Dolby Digital</li> <li>• Output channel : 5.1 channels</li> <li>• DSP : 3 (presence &amp; surround L, R)</li> </ul> <p><b>[3] 70 mm MOVIE THEATER – DTS (   )</b></p> <ul style="list-style-type: none"> <li>• Input source : DTS</li> <li>• Output channel : 5.1 channels</li> <li>• DSP : 3 (presence &amp; surround L, R)</li> </ul>	<p>Creates the extremely wide sound field of a movie theater. It precisely reproduces the source sound in detail, giving both the video and the sound field incredible reality. Any kind of video source encoded with Dolby Digital or DTS (especially large-scale movie productions) is ideal for use with this program.</p>
4	<p><b>MONO MOVIE</b></p> <ul style="list-style-type: none"> <li>• Input source : Monaural</li> <li>• Output channel : 1</li> <li>• DSP : 1</li> </ul>	<p>This program is designed specifically to enhance monaural sources. Compared to a strictly mono setting, the sound image is wider and slightly forward of the speaker pair, lending an immediacy to the overall sound.</p>
5	<p><b>TV SPORTS</b></p> <ul style="list-style-type: none"> <li>• Input source : Audio/Video</li> <li>• Output channel : 2 to 5.1 channels</li> <li>• DSP : 2 to 3 (presence &amp; surround)</li> </ul>	<p>This program is furnished with a tight sound field in which the sound will not spread excessively at the front, but the rear surround produces dynamic sound expansion.</p>

#### For Hi-Fi Audio sources

No.	PROGRAM	FEATURES
6	<p><b>Hi-Fi DSP Program</b></p> <ul style="list-style-type: none"> <li>• Input source : 2-ch PCM/Analog audio</li> <li>• Output channel : 2 channels</li> <li>• DSP : 1</li> </ul> <p><b>[1] DISCO</b></p> <p><b>[2] ROCK CONCERT</b></p> <p><b>[3] CONCERT HALL</b></p>	<p>Simulates the acoustics of disco in the heart of a lively city. The sound is dense and highly concentrated.</p> <p>Ideally suited for rock music. You will experience a dynamic and lively sound field.</p> <p>Creates the expansive ambience of a large concert hall. Orchestra and opera music are suited to this program.</p>

# PLAYING A SOURCE WITH THE DIGITAL SOUND FIELD PROCESSOR (DSP) EFFECT

Follow steps 1 to 7 shown in "TO PLAY A SOURCE" on pages 23 to 24.

Select the desired DSP program that is suitable for the source.

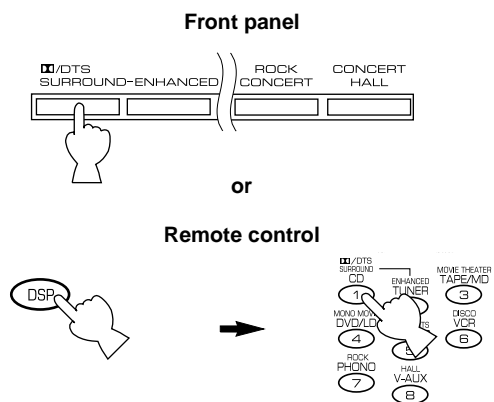

Press DSP. While the indicator is lit up for about three seconds, select a DSP program with the numeric buttons (1 to 8).

\* If the SELECTOR DIAL is set to the DSP position, you can also select a DSP program directly with the numeric buttons (1 to 8).

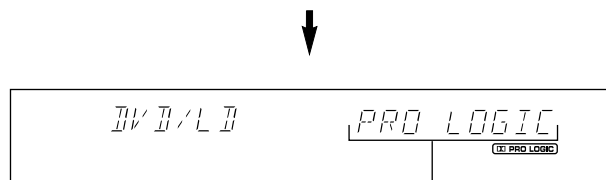

The name of the selected program appears on the display.

If desired, adjust the delay time and the output level of each speaker. (See pages 31 and 32 for details.)

The following indicators on the display show you what sound processing is being undertaken.

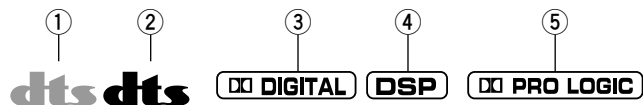

- ① This lights up in orange when a DVD source encoded with DTS is played back and DTS is decoded.
- ② This lights up in red when an LD source or a CD source encoded with DTS is played back and DTS is decoded.
- ③ This lights up when Dolby Digital is being decoded and the signals of the selected source encoded with Dolby Digital is not in 2-channel.
- ④ This lights up when the digital sound field processor is turned on.
- ⑤ This lights up when Dolby Surround is being decoded by Dolby Pro Logic.

## TO CANCEL THE SOUND EFFECT

To cancel the sound effect and monitor only the main sound, press **EFFECT** or **EFCT ON/OFF**. Press **EFFECT** or **EFCT ON/OFF** once more to turn sound effect back on.

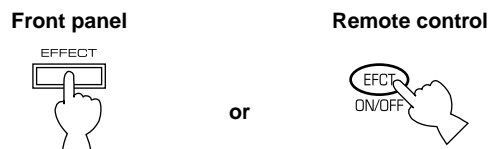

### Notes

- You can select a program for each of the input sources. Once you select a program, it is linked with the input source selected at that time. So, when you select the input source next time, the same program is automatically called up.
- When a monaural sound source is being played with **DOLBY PRO LOGIC** or **DOLBY PRO LOGIC ENHANCED**, no sound will be heard from the main speakers and the rear speakers. Sound can only be heard from the center speaker. However, if the NONE position is selected for "CNTR" in the SET MENU mode, the main speakers will output the sound of the center channel.
- When the source of signals input to the **EXTERNAL DECODER INPUT** terminals of this unit is selected, DSP cannot be used.
- If the sound effect is canceled when signals encoded with Dolby Digital or DTS are input to this unit, the signals of all channels are mixed and are output from the main speakers.
- If **EFFECT** or **EFCT ON/OFF** is pressed to turn the sound effects off when Dolby Digital or DTS is decoded, it may happen that the sound is output faintly or not output normally, depending on the source. In that case, press **EFFECT** or **EFCT ON/OFF** to turn on the sound effects.

If you change the LD (or CD) being played back with DTS being decoded to another disc that is not encoded with DTS when the red "dts" indicator lights up, playing back the newly selected disc will result in no sound output. In this state, the red "dts" indicator flashes to show that this unit is locked in the DTS-decoding mode. To play back the disc normally, change the current DTS-decoding mode to another mode by **INPUT MODE** on the front panel or by **INPUT** on the remote control so that the red "dts" indicator goes off.

# ADJUSTING THE DELAY TIME AND SPEAKER OUTPUT LEVELS

When using the digital sound field processor with the Dolby Pro Logic decoder, the Dolby Digital decoder or the DTS decoder, you can adjust the delay time between the main sound and sound effect, and each speaker's output level as you prefer.

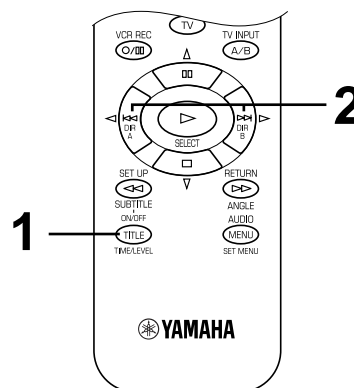
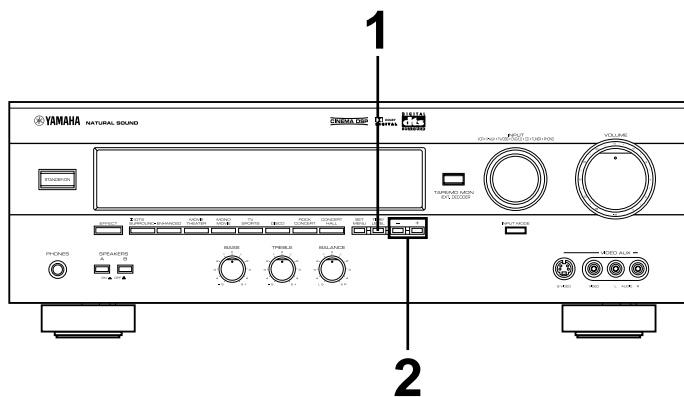

## Adjustment method

When adjusting with the remote control, set the SELECTOR DIAL to the AMP/TUN or DSP position on the remote control.



or



- 1 Press **TIME/LEVEL** once or more until the name of the item which you want to adjust appears on the display.

### Front panel



### Remote control



or

- 2 Press **+** or **-** to adjust the settings for the delay time or speaker output levels.

### Front panel

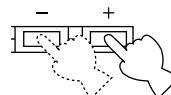

or

### Remote control

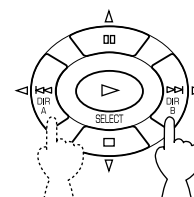

- 3 Repeat steps 1 and 2 to adjust the settings of any other item.

\* After pressing **TIME/LEVEL** once on the remote control, you can also select the name of item by pressing  $\nabla$ .

When pressed, the selection changes as follows:

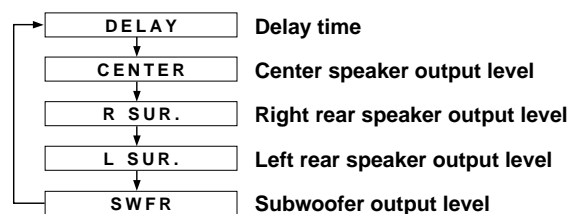

\* Pressing  $\Delta$  on the remote control changes the selection in the reverse order.

\* Depending on the setting in the SET MENU mode, you may not be able to select all these items.

## Adjusting the delay time

You can adjust the time difference between the beginning of the sound from the main speakers and the beginning of the sound effect from the rear speakers.

The larger the value, the later the sound effect is generated. This adjustment can be individually made to all programs.

### Notes

- Adding too much delay will cause an unnatural effect with some sources.
- When + or – is pressed, the sound is momentarily interrupted.

Program	Control range (ms)	Preset value
1. DOLBY PRO LOGIC	15 to 30	20
DOLBY DIGITAL	0 to 15	5
DTS	0 to 15	5
2. DOLBY PRO LOGIC/Enhanced	15 to 30	20
DOLBY DIGITAL/Enhanced	0 to 15	5
DTS/Enhanced	0 to 15	5
3. 70 mm MOVIE THEATER	15 to 30	20
70 mm MOVIE THEATER – DOLBY D.	1 to 99	16
70 mm MOVIE THEATER – DTS	1 to 99	16
4. MONO MOVIE	1 to 99	49
5. TV SPORTS	1 to 99	9
6. DISCO	1 to 99	40
7. ROCK CONCERT	1 to 99	16
8. CONCERT HALL	1 to 99	44

## Adjusting the output level of the center, right rear and left rear speakers, and subwoofer

If desired, you can adjust the sound output level of each speaker even if the output level has already been set in "SPEAKER BALANCE ADJUSTMENT" on pages 20 to 22.

### Notes

- The output level of the center speaker cannot be adjusted when the **DISCO**, **ROCK CONCERT** or **CONCERT HALL** program is selected, and the input signal is analog, PCM audio, or encoded with Dolby Digital in 2-channel.
- If the function "CNTR" in the SET MENU mode is set to the NONE position, the sound output level of the center speaker cannot be adjusted. This is because, in this mode, the center speaker sound is automatically output from the left and right main speakers.
- Once the output level has been adjusted, the level will be the same for all digital sound field programs.

Speaker	Control range (dB)	Preset value
CENTER	MIN, –20 to +10	0
RIGHT REAR	MIN, –20 to +10	0
LEFT REAR	MIN, –20 to +10	0
SUBWOOFER	MIN, –20 to 0	0

## Memory back-up

The memory back-up circuit prevents the stored data from being lost when this unit is set in the standby mode. If, however, the power plug is disconnected from the AC outlet or the power is cut due to temporary power failure for more than one week, the latest values for the delay time and the center/rear/subwoofer output levels that were set will automatically return to the preset values. If so, they can be re-set by simply following the adjustment method on page 31.



# ADJUSTMENTS IN THE “SET MENU” MODE

The following ten types of functions will maximize the performance of your system and expand your enjoyment for audio listening and video watching.

1. **CNTR (CENTER SPEAKER)**
2. **REAR (REAR SPEAKERS)**
3. **MAIN (MAIN SPEAKERS)**
4. **BASS (LFE/BASS OUT)**
5. **M.LVL (MAIN LEVEL)**
6. **D.D.LFE  
(DOLBY DIGITAL LFE LEVEL)**
7. **D.RNG (DYNAMIC RANGE)**
8. **DTS LFE (DTS LFE LEVEL)**
9. **C.DELAY (CENTER DELAY)**
10. **GUARD (MEMORY GUARD)**
11. **INPUT (INPUT MODE)**

For details on “CNTR”, “REAR”, “MAIN”, “BASS” and “M.LVL”, see page 18. (Once you have selected the appropriate settings, you do not have to change any settings unless an alteration is made in your speaker system.)

## D.D.LFE (Adjusting the level of the LFE channel for Dolby Digital)

**Control range:** –20 dB to 0 dB (in 1 dB steps)  
**Preset value:** 0 dB

\* This adjustment is effective only when Dolby Digital is being decoded and the signals of the selected source encoded with Dolby Digital contain LFE signals.

This adjusts the output level of the LFE channel. If the LFE signals are mixed with signals of other channels and they are output from the same speakers, the ratio of the LFE signal level to the level of the other signals can be adjusted. (See page 6 for details about the LFE channel.)

## D.RNG (Adjusting the dynamic range)

**Choices:** MAX/STD/MIN  
**Preset position:** MAX

\* This adjustment is effective only when Dolby Digital is being decoded.

“Dynamic range” is the difference between the maximum level and the minimum level of sounds.

Sounds on a movie originally designed for movie theaters feature a very wide dynamic range.

Dolby Digital technology can modify the original sound track into a home audio format with this wide dynamic range unchanged.

Powerful sounds of extremely wide dynamic range are not always suitable for home use. Depending upon the condition of your listening environment, it may not be possible to increase the sound output to a level as high as that in a movie theater.

However, at the normal level suitable for listening in your room, the low-level parts of source sound often cannot be heard well because they will be lost among noise in your environment. Dolby Digital technology has also made it possible to reduce an original sound track’s dynamic range for a home audio format by “compressing” the sound data.

**MAX:** In this position, a source encoded with Dolby Digital is reproduced in the original sound track’s wide dynamic range to provide you with powerful sounds just like those in a movie theater. Selecting this position will be even better if you can listen to a source at a high output level in a room specially soundproofed for audio/video enjoyment.

**STD (Standard):**

In this position, a source encoded with Dolby Digital is reproduced in the “compressed” dynamic range of the source that is suitable for low-level listening.

**MIN:** In this position, the dynamic range is more reduced than in the STD position.

Selecting this position will be effective when you must listen to a sound source at a low level.

\* In this position, it may happen that sound is output faintly or not output normally depending on the source. In that case, select the MAX or STD position.

## DTS LFE (Adjusting the level of the LFE channel for DTS)

**Control range:** –10 dB to +10 dB (in 1 dB steps)  
**Preset value:** 0 dB

\* This adjustment is effective only when DTS is being decoded and the signals of the selected source encoded with DTS contain LFE signals.

This adjusts the output level of the LFE channel. If the LFE signals are mixed with signals of other channels and they are output from the same speakers, the ratio of the LFE signal level to the level of the other signals can be adjusted. (See page 6 for details about the LFE channel.)

## C.DELAY [Adjusting the delay of center sounds (dialog, etc.)]

**Control range: 0 ms to 5 ms (in 1 ms steps)**  
**Preset value: 0 ms**

- \* This adjustment is effective only when Dolby Digital or DTS is being decoded and the signals of the selected source encoded with Dolby Digital or DTS contain center-channel signals.

This adjusts the delay between the main sound (on the main channels) and dialog, etc. (on the center channel). The larger the value, the later the dialog, etc. is generated.

This is for making sounds from the left main, center and right main speakers reach your listening position at the same time. This is achieved by delaying the sound from the center speaker if the distance from the center speaker to your listening position is shorter than the distance from the left or right main speaker to your listening position.

## GUARD (Memory guard)

**Choices: ON/OFF**  
**Preset position: OFF**

If you wish to prevent accidental alterations to SET MENU and other adjustments on this unit, select ON. The following functions on this unit can be locked by this operation:

- Other functions in the SET MENU mode
- Functions in the TIME/LEVEL mode
- Functions when using **TEST**

## INPUT (Selecting the mode of the TV/DBS input)

**Choices: AUTO/LAST**  
**Preset position: AUTO**

You can designate the input mode that is automatically selected when the power of this unit is switched on for only the sources connected to the TV/DBS input terminals of this unit.

- AUTO:** In this position, the AUTO input mode is always selected when the power for this unit is switched on.
- LAST:** In this position, the input mode you selected last time is memorized and will not be changed when the power is switched on again.

- \* See page 25 for details on switching the input mode.

## Adjustment method

Adjustments should be made while watching the information on this unit's display.

When adjusting with the remote control, set the SELECTOR DIAL to the AMP/TUN or DSP position on the remote control.

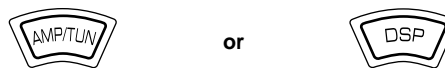

Press **SET MENU** once or more so that the function which you want to change appears on the display.

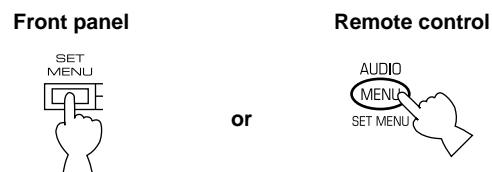

- \* After pressing **SET MENU** once on the remote control, you can also select the title by pressing  $\nabla$ . (Pressing  $\Delta$  goes back one selection.)

Press **+** or **-** to select any desired position or to edit parameters of the chosen function.

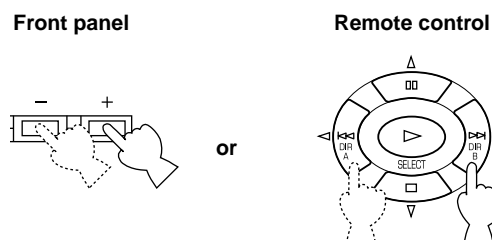

Repeat these steps to change or adjust the settings of any other function.

## Memory back-up

The memory back-up circuit prevents the stored data from being lost when this unit is set in the standby mode. If, however, the power plug is disconnected from the AC outlet or the power is cut due to temporary power failure for more than one week, the settings of the SET MENU mode will automatically return to the factory settings. If so, they can be re-set by simply following the procedure above.

# REMOTE CONTROL

You can use the remote control to control not only this unit but also other components connected to it. The remote control is factory set to control this unit and most YAMAHA audio components.

**To control other brands of components, you must preset the remote control with the manufacturers' codes listed from page 310.**

## Components which can be controlled

There are nine positions that you can select to control connected components with this remote control. When turning the SELECTOR DIAL, the position changes as follows:

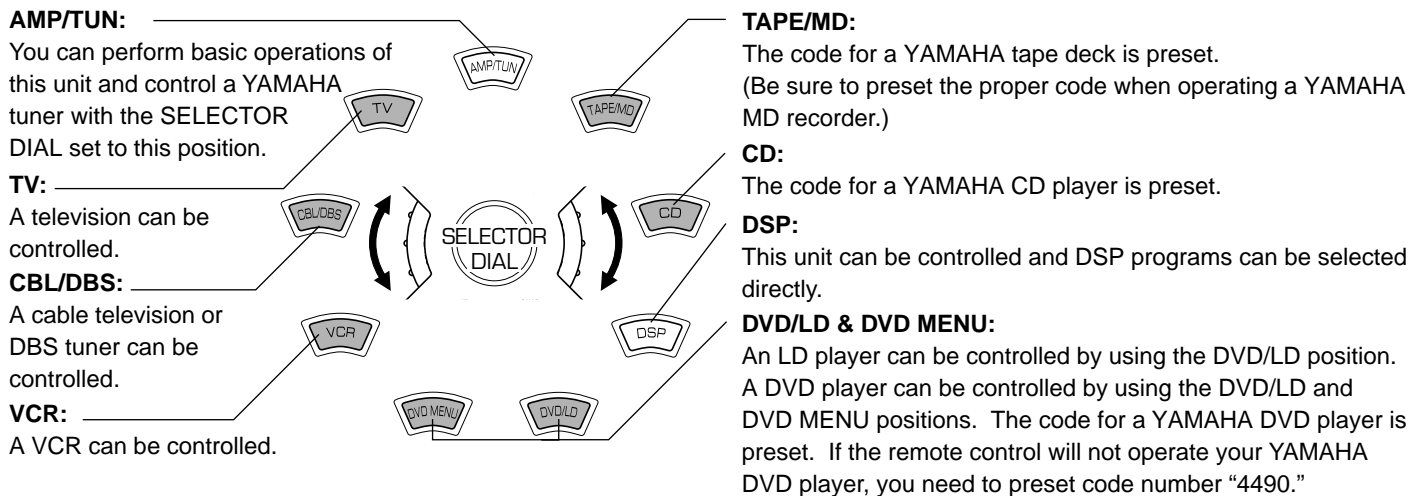

### Notes

- The shaded positions in the diagram above indicate that you can preset the code for the manufacturer of your component. Note that you can preset only one code for one position. (See "SETUP CODES" on page 41 for details).
- DVD/LD and DVD MENU positions:
  - Be sure that the SELECTOR DIAL is set to the DVD/LD position before presetting the code for a DVD or an LD player. The code that you preset to the DVD/LD position is also simultaneously preset to the DVD MENU position. You cannot preset the code for a DVD player when the SELECTOR DIAL is set to the DVD MENU position.
  - DVD MENU operations cannot be performed for some DVD players.
- When using a second (and third) VCR (See "To use a second (and third) VCR" on page 41 for details.):
  - If you are not using a CBL/DBS (cable TV or DBS tuner), the second (or third) VCR can be preset by using the CBL/DBS position.
  - If you are not using a DVD player, the second (or third) VCR can be preset by using the DVD MENU position. Note that in this case you must preset the code for an LD player to the DVD/LD position even if an LD player is not being used.
- The button functions on the remote control differ depending on the position selected by the SELECTOR DIAL. Refer to the following pages for details.

## Basic operation

- Select the position for the component that you want to control by turning the SELECTOR DIAL.  
Note: Turn the SELECTOR DIAL until it stops with a click.

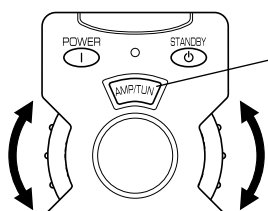

The position name is displayed in this window.

- Press the desired operation button.  
Note: Press the button with the remote control aimed at the front panel.

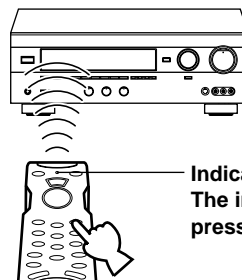

Indicator  
The indicator will flash when the button is pressed.

The lightly marked buttons do not function.

## AMP/TUN

Note: TV POWER and TV VOLUME function if you have preset the code for your TV.

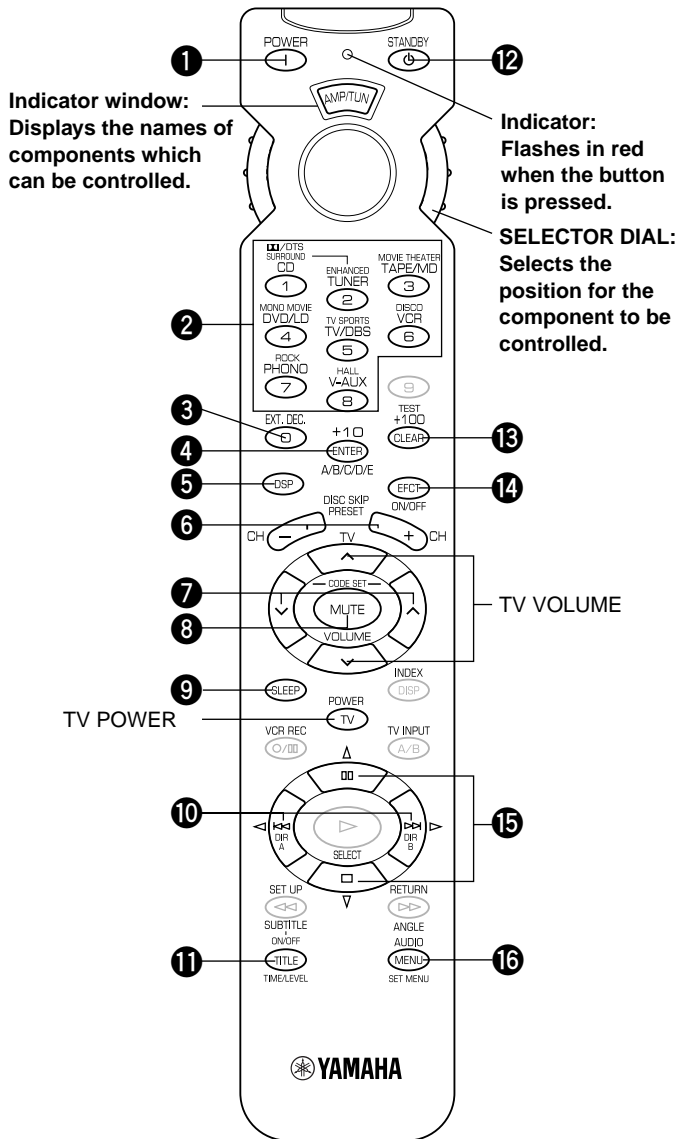

### 1 POWER

This button turns the unit on.

### 2 INPUT

Press one of these buttons to select the required input source.

### 3 EXT. DEC.

Press this button when using an external decoder.

### 4 A/B/C/D/E

Press this button to select a group of preset stations when using the YAMAHA tuner.

### 5 DSP

Press this button. While the indicator is lit up for about three seconds, select a DSP program by using the number buttons (1 to 8). No DSP program can be selected after the indicator goes off.

### 6 PRESET (+/-)

Press these buttons to select the preset station number when using the YAMAHA tuner.

### 7 VOLUME ( ^ v )

Press these buttons to adjust the volume level.

### 8 MUTE

Press this button to mute the sound. To cancel mute, press this button once more, or press the operation buttons of this unit.

### 9 SLEEP

Press this button to set the SLEEP timer.

### 10 < (LEFT), > (RIGHT)

These buttons are used to adjust the settings of the SET MENU mode and the TIME/LEVEL mode.

### 11 TIME/LEVEL

Press this button to set the unit in the TIME/LEVEL mode and to select the item.

### 12 STANDBY

Press this button to set this unit in the standby mode.

### 13 TEST

Press this button to output a test tone for adjusting the output level of the speakers.

### 14 EFCT (EFFECT) ON/OFF

Press this button to turn on or off the DSP program which includes the Dolby Pro Logic decoder, the Dolby Digital decoder and the DTS decoder.

### 15 v (NEXT), ^ (BACK)

These buttons are used to advance or back one selection in the SET MENU mode and TIME/LEVEL mode.

### 16 SET MENU

Press this button to set the unit in the SET MENU mode and to select functions.

## DSP

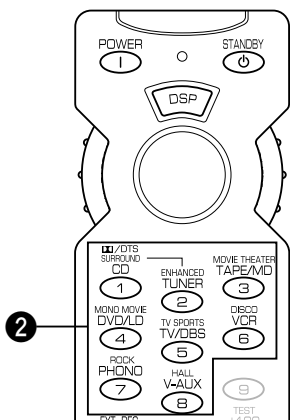

### 2 DSP program

Press one of these buttons to select the required DSP program (1 to 8). When you select the input source, set the SELECTOR DIAL to the AMP/TUN position.

Note: The function of all buttons other than DSP program is the same as that with the AMP/TUN position.

The lightly marked buttons do not function. See "AMP/TUN" on page 36 for those buttons which are not described here. Please refer to the owner's manual for details of each component.

**■ TAPE/MD**

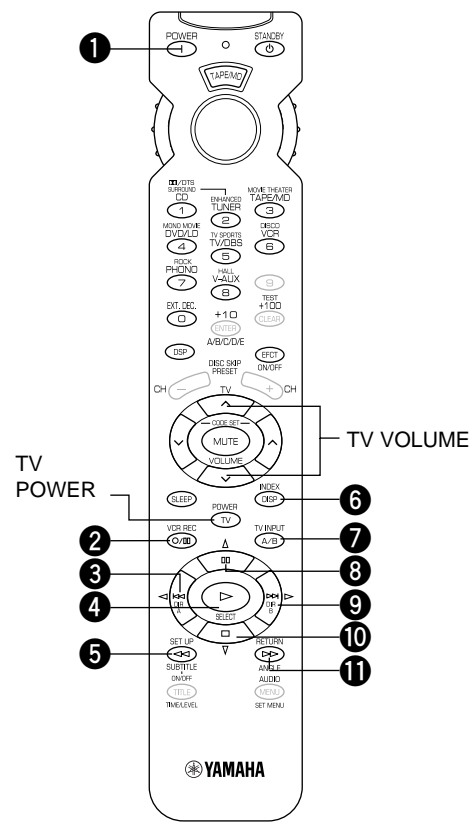

**Notes:**

- **TV POWER** and **TV VOLUME** function if you have preset the code for your TV.
- Be sure to preset the proper code for your MD recorder.

**TAPE**

- 1 POWER**  
This button turns the unit on under factory settings. If another code for your tape deck whose remote control has a power button is preset, the button will turn on the tape deck.
- 2 ○/⏸ (REC/PAUSE)**  
Press this button to give a pause in recording on the tape deck.
- 3 ◀ DIR A**  
Press this button to select the playing direction of deck A.
- 4 ▶ (PLAY)**  
Press this button to play a tape.
- 5 ◀◀ (REWIND)**  
Press this button to rewind a tape.
- 7 DECK A/B**  
Press this button to select deck A or B on the double cassette tape deck.
- 9 ▶ DIR B**  
Press this button to select the playing direction of deck B.
- 10 ◻ (STOP)**  
Press this button to stop the operation of a tape.
- 11 ▶▶ (FAST FORWARD)**  
Press this button to fast forward a tape.

**MD**

- 1 POWER**  
This button turns the unit on if you have preset the code for the YAMAHA MD recorder. If another code for your MD recorder whose remote control has a power button is preset, the button will turn on the MD recorder.
- 2 ○/⏸ (REC/PAUSE)**
- 3 ⏮ (SKIP)**
- 4 ▶ (PLAY)**
- 5 ◀◀ (SEARCH)**
- 6 DISP (DISPLAY)**
- 8 ⏸ (PAUSE)**
- 9 ⏭ (SKIP)**
- 10 ◻ (STOP)**
- 11 ▶▶ (SEARCH)**

**■ CD**

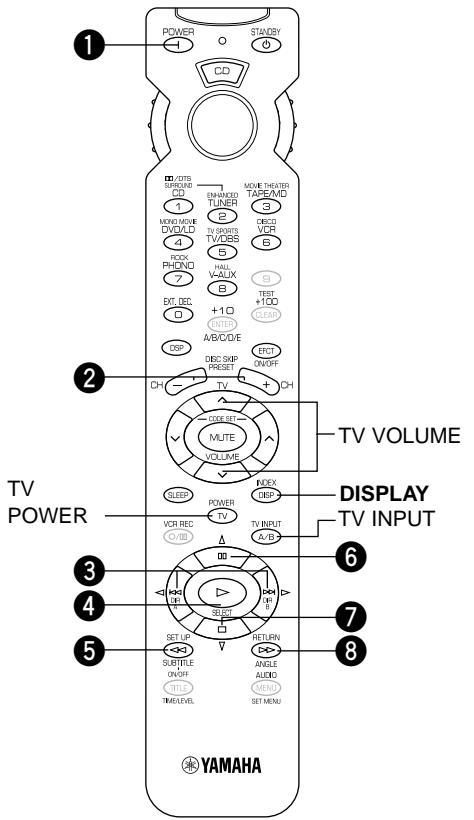

**Note:** **TV POWER**, **TV VOLUME** and **TV INPUT** function if you have preset the code for your TV.

- 1 POWER**  
This button turns the unit on under factory settings. If another code for your CD player whose remote control has a power button is preset, the button will turn on the CD player.
- 2 DISC SKIP (+/-) (for a CD player with a CD changer)**  
Press these buttons to skip to the next or previous CD.
- 3 ⏭, ⏮ (SKIP)**  
Press ⏭ to skip to the beginning of the next track. Press ⏮ to skip to the beginning of the previous track.
- 4 ▶ (PLAY)**  
Press this button to play a CD.
- 5 ◀◀ (SEARCH)**  
This button initiates a backward search on the track that is playing to find the point from which you want to listen.
- 6 ⏸ (PAUSE)**  
Press this button to give a pause in operation. This button functions as **PAUSE/STOP\*** for operating YAMAHA CD players under factory settings.
- 7 ◻ (STOP)**  
Press this button to stop operation. This button functions as **PAUSE/STOP\*** for operating YAMAHA CD players under factory settings.
- 8 ▶▶ (SEARCH)**  
This button initiates a fast-forward search on the track that is playing to find the point from which you want to listen.

\* **PAUSE/STOP** function ... Press the button once to give a pause in operation and once more to stop operation.

The lightly marked buttons do not function. See "AMP/TUN" on page 36 for those buttons which are not described here. Please refer to the owner's manual for details of each component.

## ■ DVD/LD

### POWER

**(DVD)** This button turns the unit on under factory settings. If another code for your DVD player whose remote control has a power button is preset, the button will turn on the DVD player.

**(LD)** This button turns the unit on if you have preset the code for the YAMAHA LD player. If another code for your LD player whose remote control has a power button is preset, the button will turn on the LD player.

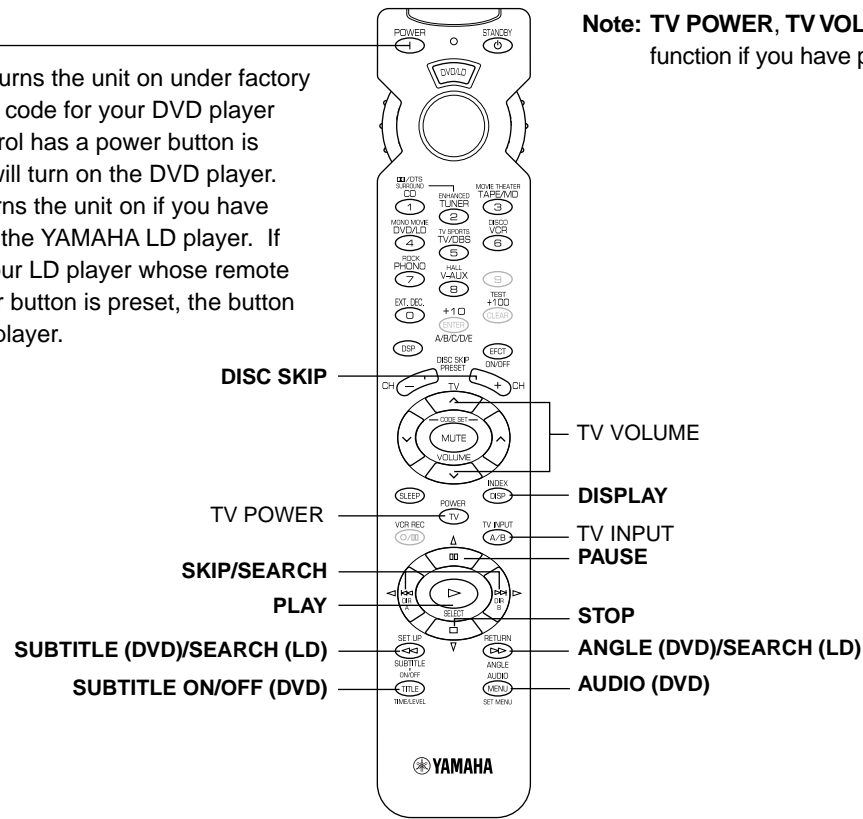

## ■ DVD MENU

### POWER

This button turns the unit on under factory settings. If another code for your DVD player whose remote control has a power button is preset, the button will turn on the DVD player.

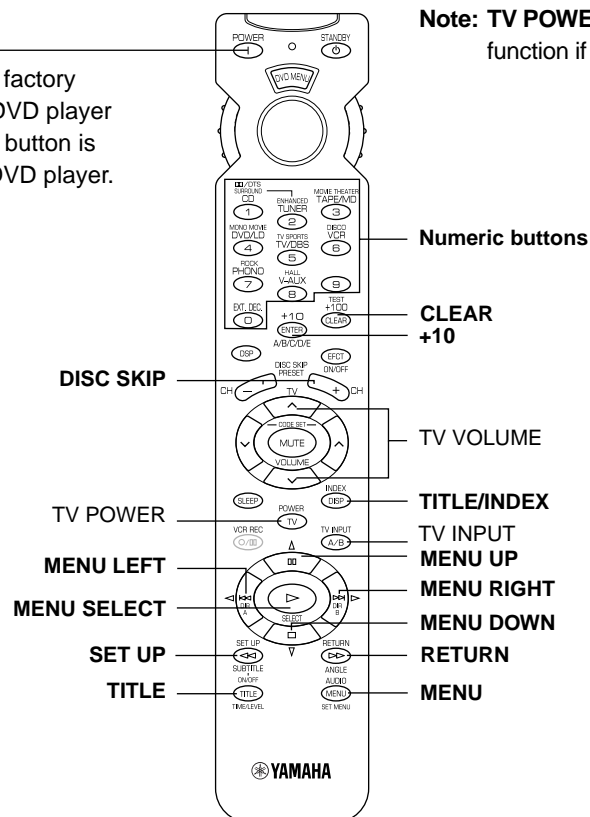

The lightly marked buttons do not function. See "AMP/TUN" on page 36 for those buttons which are not described here. Please refer to the owner's manual for details of each component.

**VCR**

**Note:** TV POWER, TV VOLUME and TV INPUT function if you have preset the code for your TV.

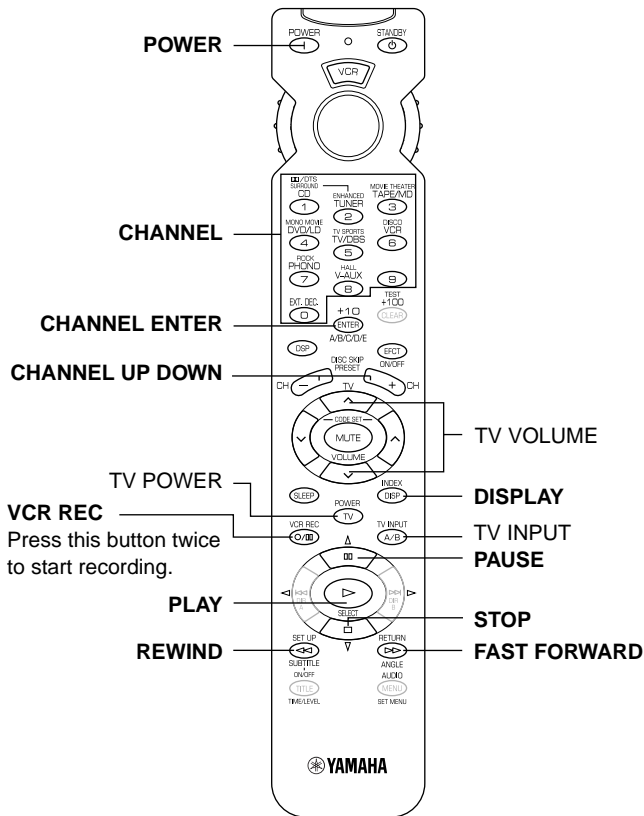

**TV**

**Note:** You can only control your VCR if you have preset the code for it.

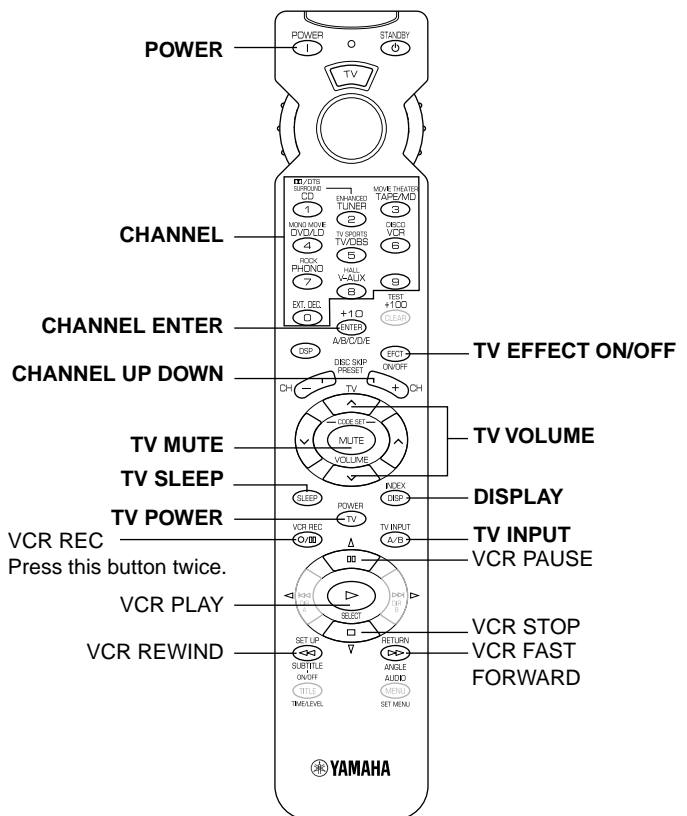

**CBL/DBS**

**Note:** TV POWER, TV VOLUME and TV INPUT function if you have preset the code for your TV.

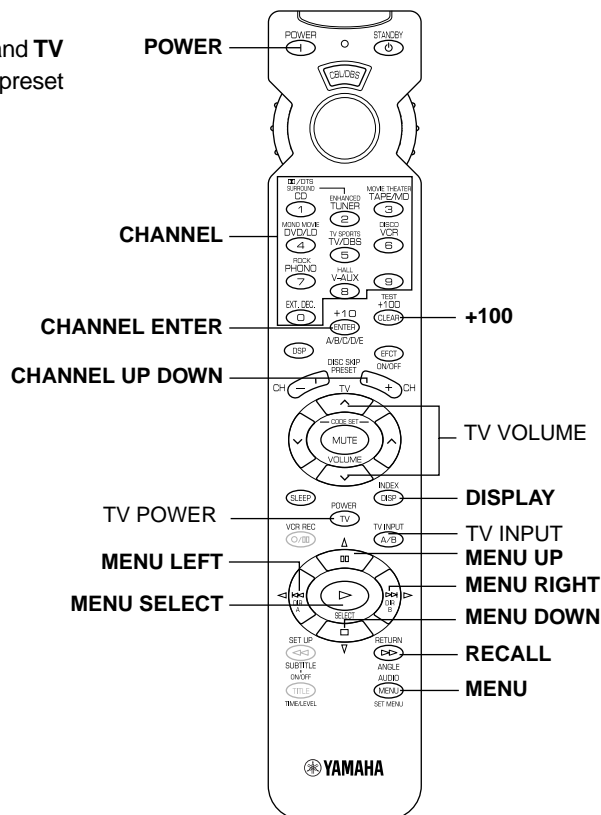

## NOTES ABOUT THE REMOTE CONTROL

### Battery installation

1. Turn the remote control over and slide the battery compartment cover in the direction of the arrow.
2. Insert the batteries (AA, R6 or UM-3 type) according the polarity markings on the inside of the battery compartment.
3. Close the battery compartment cover.

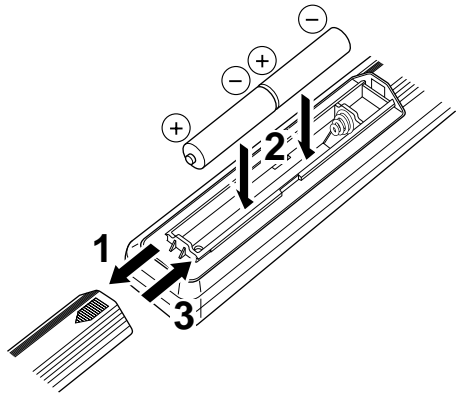

### Battery replacement

If the remote control operates only when it is close to the unit, the batteries are weak. Replace all the batteries with new ones.

Be sure to replace the batteries within about two minutes. If it takes longer than two minutes, the codes preset for the remote control will return to the factory settings.

#### Notes

- Use only AA, R6 or UM-3 batteries for replacement.
- Be sure the battery polarity is correct. (See the illustration inside the battery compartment.)
- Remove the batteries if the remote control will not be used for an extended period of time.
- If the batteries have leaked, dispose of them immediately. Avoid touching the leaked material or letting it come into contact with clothing, etc. Clean the battery compartment thoroughly before installing new batteries.

### Remote control operation range

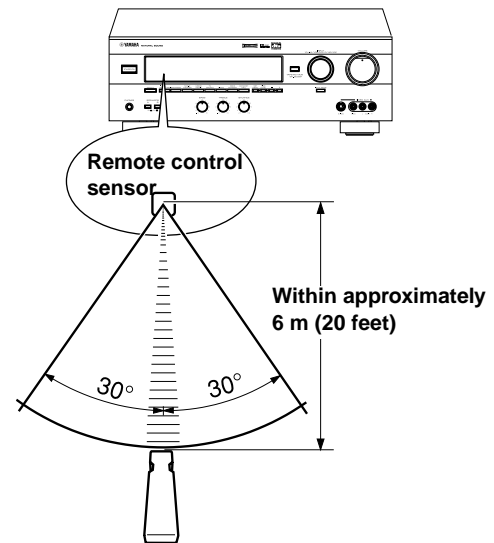

#### Notes

- There should be no large obstacles between the remote control and the unit.
- If the remote control sensor is directly illuminated by strong lighting (especially from an inverter type of fluorescent lamp), it might cause the remote control not to work correctly. In this case, reposition the unit to avoid direct lighting.



# SETUP CODES

## Presetting the remote control

Perform the presetting procedure for each component you want to control with the remote control.

**Note:** If your component does not respond to any of the codes listed for the manufacturer, use the original remote control that was supplied with the component.

### To control your components (MD recorder, DVD player, TV, etc.)

1. Turn on the component to be used.
2. Set the SELECTOR DIAL to the desired position for the component (TAPE/MD, DVD/LD, TV, etc.).

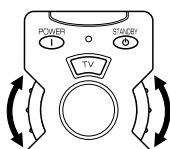

3. Press both **VOLUME** buttons ( ^ v ) for about four seconds at the same time so that the indicator flashes twice.

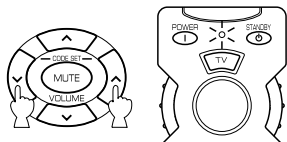

4. Use the numeric buttons to enter the four-digit manufacturer's code for the component to be used. Make sure that the indicator flashes twice. If the indicator does not flash, repeat step 3 and re-enter the code.

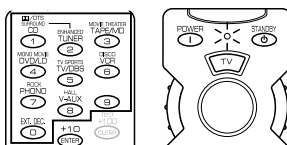

5. Press **POWER** (or any other button) on the remote control to check if you have preset the code correctly. If the component cannot be controlled with the remote control, try entering another code for the same manufacturer.

### To use a second (and third) VCR

You can use the CBL/DBS and/or DVD MENU positions to control a second (and/or third) VCR if a CBL (or DBS) or DVD player is not being used.

If you are using the DVD MENU position for a second (or third) VCR, you must preset the code for an LD player to the DVD/LD position.

1. Turn on the VCR to be used.
2. Set the SELECTOR DIAL to the CBL/DBS or DVD MENU position.

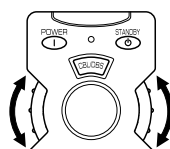

3. Press both **VOLUME** buttons ( ^ v ) for about four seconds at the same time so that the indicator flashes twice.

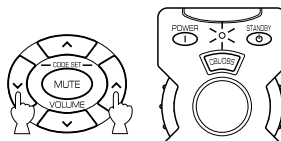

4. Press **MUTE**.

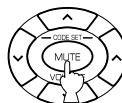

5. Use the numeric buttons to enter the four-digit code for the second (or third) VCR. Make sure that the indicator flashes twice. If the indicator does not flash, repeat steps 3 and 4, and re-enter the code.

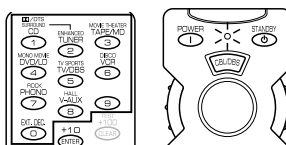

6. Press **POWER** (or any other button) on the remote control to check if you have preset the code correctly. If the VCR cannot be controlled with the remote control, try entering another code for the same manufacturer.

### Returning to the factory-set codes

To return all components to the factory-set codes, follow these steps.

1. Set the SELECTOR DIAL to a position other than the AMP/TUN or DSP position.
2. Press both **VOLUME** buttons ( ^ v ) for about four seconds at the same time so that the indicator flashes twice.
3. Enter code number "9987".
4. Make sure that the indicator flashes twice.

To return each component to the factory-set code, follow these steps.

1. Set the SELECTOR DIAL to the position for the component to be returned to the factory-set code.
2. Press both **VOLUME** buttons ( ^ v ) for about four seconds at the same time so that the indicator flashes twice.
3. Enter code number "9999".
4. Make sure that the indicator flashes twice.

The following codes are preset as the factory settings.

#### Factory-set codes

POSITION	Component	Code
TV	TV	0037
CBL/DBS	DBS tuner	2455
VCR	VCR	3072
DVD/LD	DVD player	4545 YAMAHA
CD	CD player	6187 YAMAHA
TAPE/MD	Tape deck	8524 YAMAHA

We recommend that you write all the code numbers you have preset on the "Quick Reference Card."

# TROUBLESHOOTING

If the unit fails to operate normally, check the following points to determine whether the fault can be corrected by the simple measures suggested. If it cannot be corrected, or if the fault is not listed in the SYMPTOM column, disconnect the power cord and contact your authorized YAMAHA dealer or service center for help.

	SYMPTOM	CAUSE	REMEDY
Amplifier	<b>The unit fails to turn on when STANDBY/ON is pressed, or set in the standby mode suddenly soon after the power has been turned on.</b>	The power cord is not plugged in or the plug is not completely inserted.	Firmly plug in the power cord.
		The <b>IMPEDANCE SELECTOR</b> switch on the rear panel is not fully set to the upper or lower end.	Set the switch fully to the upper or lower end when the unit is in the standby mode.
	<b>The unit does not work normally.</b>	The internal microcomputer has been frozen by an external electric shock (lightning, excessive static electricity, etc.) or by a power supply with low voltage.	Set the unit in the standby mode and disconnect the AC power cord from the AC outlet. After about 30 seconds have passed, connect the power and operate the unit again.
	<b>No sound or no picture.</b>	Incorrect output cord connections.	Connect the cords properly. If the problem persists, the cords may be defective.
		An appropriate input source has not been selected.	Select an appropriate input source with <b>INPUT</b> or <b>TAPE/MD MON / EXT. DECODER</b> .
		<b>SPEAKERS</b> have not been set properly.	Set <b>SPEAKERS</b> corresponding to the speakers in use to the ON position.
		The speaker connections are not secure.	Secure the connections.
		Digital signals other than PCM audio and Dolby Digital or DTS encoded signals which this unit cannot reproduce are input to this unit by playing a CD-ROM etc.	Play a source whose signals this unit can reproduce.
	<b>No picture.</b>	There is no S video terminal connection between this unit and the TV, although S video signals are input to this unit.	Connect this unit's <b>S VIDEO MONITOR OUT</b> terminal to the TV's S video input terminal.
	<b>The sound suddenly goes off.</b>	The protection circuit has been activated because of a short circuit, etc.	Set the unit in the standby mode and then switch on again to reset the protection circuit.
		The SLEEP timer has functioned.	Turn on the power, and play the source again.
	<b>Only the speakers on one side can be heard.</b>	Incorrect setting of <b>BALANCE</b> .	Adjust it to the appropriate position.
		Incorrect cord connections.	Connect the cords properly. If the problem persists, the cords may be defective.
	<b>A "humming" sound can be heard.</b>	Incorrect cord connections.	Firmly connect the audio plugs. If the problem persists, the cords may be defective.
		No connection from the turntable to the <b>GND</b> terminal.	Make the GND connection between the turntable and this unit.
<b>The volume level is low while playing a record.</b>	The record is being played on a turntable with an MC cartridge.	The turntable should be connected to the unit through the MC head amplifier.	
<b>The volume level cannot be increased, or the sound is distorted.</b>	The component connected to the <b>REC OUT</b> terminals of this unit is in the standby mode.	Turn on the power to the component.	

	SYMPTOM	CAUSE	REMEDY
Amplifier	No sound from the effect speakers.	The sound effect setting is off.	Press <b>EFFECT</b> on the front panel or <b>EFCT ON/OFF</b> on the remote control to turn it on.
		A Dolby Surround or DTS decoding program is being used with material not encoded with Dolby Surround or DTS.	Use a different sound field program.
	No sound from the rear speakers.	The sound output level of the rear speakers is set to minimum.	Raise the sound output level of the rear speakers.
		A monaural sound source is being played in the <b>DOLBY PRO LOGIC</b> or <b>DOLBY PRO LOGIC ENHANCED</b> program.	Select another sound field program suitable for the monaural sound source.
	No sound from the center speaker.	The sound output level of the center speaker is set to minimum.	Raise the sound output level of the center speaker.
		The function "CNTR" in the SET MENU is set to the NONE position.	Select the LARGE or SMALL position.
		Incorrect sound field program selection.	Select the appropriate program.
		The input signals of the source encoded with Dolby Digital or DTS do not have center channel signals.	Refer to the instructions for the source being currently played.
	The sound field cannot be recorded.	It is not possible to record the sound field on a tape deck or MD recorder connected to the unit's <b>REC OUT</b> terminals.	
	The DVD/LD, TV or DBS source cannot be recorded on a tape deck, MD recorder or VCR connected to this unit.	The DVD/LD player, TV or DBS tuner is connected to the unit by only the digital terminals.	Make additional connections between the analog terminals.
Remote control	The remote control does not work.	Direct sunlight or lighting (from an inverter type of fluorescent lamp, etc.) is striking the remote control sensor of this unit.	Change the position of this unit.
		The manufacturer's code has not been set properly.	Set the code again.
		The proper manufacturer's code for the component to be controlled has not been set.	Try entering another code for the same manufacturer.
		The component to be controlled has not been selected.	Set the SELECTOR DIAL to the proper position.
Others	The sound is degraded when listening with the headphones to a CD player or tape deck that is connected to this unit.	This unit is in the standby mode.	Turn on the power of the unit.
	There is noise interference from digital or high-frequency equipment or the unit.	The unit is too close to the digital or high-frequency equipment.	Move the unit further away from such equipment.

## When playing back a source encoded with DTS

SYMPTOM	CAUSE	REMEDY
A loud hissing noise is heard when you play back a source encoded with DTS.	The player which plays back the source is not connected to a digital audio signal input terminal of this unit.	The player must be connected to a digital audio signal input terminal of this unit besides the analog audio signal terminal connections.
	The ANALOG input mode is selected on this unit.	Select a proper input mode on this unit to turn on the DTS decoder built into the unit.
A percussive noise is heard when you begin playing back a source encoded with DTS.	If the AUTO input mode is selected, depending on some sources, there may be a case that a noise is heard while this unit is identifying the format of the input signal.	Set the input mode of the currently selected input source to DTS.
No sound is heard when you play back a source encoded with DTS, even though the AUTO input mode is selected on this unit.	The DTS decoder built into this unit does not function because the player has a digital volume control and it is set at a position other than "maximum," "neutral" or "ineffective."	Set the player's digital volume control at the maximum, neutral or ineffective position.
No sound is heard when you play back an MD or DAT on to which you have recorded a source encoded with DTS.	A source encoded with DTS cannot be recorded on to an MD or DAT.	
No sound is heard when you play back a source (CD, etc.) even though the currently selected input mode is AUTO.	In the AUTO mode, the DTS-decoding mode cannot be automatically changed to the normal (PCM) digital signal input mode.	Press <b>INPUT MODE</b> on the front panel or <b>INPUT</b> (for the currently selected source) on the remote control so that AUTO appears on the display.

### Notes

- It is necessary to use a DTS decoder to play back a source encoded with DTS, so the player which plays back the source must be connected to a digital audio input terminal of this unit in the way described in this manual. If this connection is not made or only a D-to-A converter is being used without using a DTS decoder, when you play back the source, only a loud hissing noise will be heard.
- If you make a search (or skip, etc.) operation while playing back a source encoded with DTS, the "dts" indicator goes out from the display. This is because this unit automatically changes the DTS-decoding mode to the standard (PCM) digital signal input mode to prevent a noise from being output.

# SPECIFICATIONS

## AUDIO SECTION

### Minimum RMS Output Power

8 ohms, 20 Hz to 20 kHz, 0.04% THD

MAIN L/R .....	65 W + 65 W
CENTER .....	65 W
REAR L/R .....	65 W + 65 W

8 ohms, 1 kHz, 0.07% THD

MAIN L/R .....	80 W + 80 W
CENTER .....	80 W
REAR L/R .....	80 W + 80 W

### Maximum Power

[China and General models only]

8 ohms, 1 kHz, 10% THD

MAIN L/R .....	105 W + 105 W
CENTER .....	105 W
REAR L/R .....	105 W + 105 W

### Dynamic Power per Channel

(by IHF Dynamic Headroom measuring method)

MAIN L/R	
8/6/4/2 ohms .....	90/110/135/160 W

### DIN Standard Output Power per Channel

[Europe model only]

4 ohms, 1 kHz, 0.7% THD .....	110 W
-------------------------------	-------

### IEC Power

[Europe model only]

8 ohms, 1 kHz, 0.04% THD ....	75 W + 75 W
-------------------------------	-------------

### Power Band Width

MAIN L/R	
8 ohms, 35 W, 0.1% THD	10 Hz to 50 kHz

### Damping Factor (SPEAKER A)

8 ohms, 20 Hz to 20 kHz .....	60 or more
-------------------------------	------------

### Input Sensitivity/Impedance

PHONO MM .....	2.5 mV/47 k-ohms
CD/TAPE-MD/DVD-LD/TV-DBS/VCR/ VIDEO AUX .....	150 mV/47 k-ohms
EXT. DECODER	
MAIN L/R .....	150 mV/47 k-ohms
CENTER/SURROUND L/R/SUBWOOFER .....	150 mV/40 k-ohms

### Maximum Input Signal

PHONO MM	
1 kHz, 0.1% THD .....	100 mV or more
CD/TAPE-MD/DVD-LD/TV-DBS/VCR/ VIDEO AUX (EFFECT ON) 1 kHz, 0.5% THD .....	2.2 V or more

### Output Level/Impedance

REC OUT .....	150 mV/1.2 k-ohms
PRE OUT	
[U.K. and Europe models only] .....	2.1 V/1.2 k-ohms
SUBWOOFER	
(MAIN SP: SMALL) .....	4.0 V/1.2 k-ohms

### Headphones Jack Rated Output/Impedance

CD/TAPE-MD/DVD-LD/TV-DBS/VCR/ VIDEO AUX input, 1 kHz, 150 mV, 8 ohms .....	0.5 V/390 ohms
--	----------------

### Frequency Response (20 Hz to 20 kHz)

CD/TAPE-MD/DVD-LD/TV-DBS/VCR/ VIDEO AUX to MAIN L/R SP OUT .....	0±0.5 dB
--	----------

### RIAA Equalization Deviation

PHONO MM .....	0±0.5 dB
----------------	----------

### Total Harmonic Distortion (20 Hz to 20 kHz)

PHONO MM to REC OUT 1 V .....	0.02% or less
CD/TAPE-MD/DVD-LD/TV-DBS/VCR/ VIDEO AUX (EFFECT OFF) to MAIN SP OUT 35 W/8 ohms .....	0.025% or less

### Signal-to-Noise Ratio (IHF-A Network)

PHONO MM to REC OUT (5 mV, Input Shorted) [U.K. and Europe models] ...	81 dB or more
[China and General models] .....	86 dB or more
CD/TAPE-MD/DVD-LD/TV-DBS/VCR/ VIDEO AUX (EFFECT OFF) to MAIN SP OUT (150 mV, Input Shorted) .....	96 dB or more

### Residual Noise (IHF-A Network)

MAIN L/R SP OUT .....	150 µV or less
-----------------------	----------------

### Channel Separation

(Vol. -30 dB, EFFECT OFF) PHONO MM (Input Shorted, 1 kHz/10 kHz) .....	60 dB or more/55 dB or more
CD/TAPE-MD/DVD-LD/TV-DBS/VCR/ VIDEO AUX (Input 5.1 k-ohms Terminated, 1 kHz/10 kHz) .....	60 dB or more/45 dB or more

### Tone Control Characteristics

BASS: Boost/cut .....	±10 dB (50 Hz)
Turnover Frequency .....	350 Hz
TREBLE: Boost/cut .....	±10 dB (20 kHz)
Turnover Frequency .....	3.5 kHz

### Filter Characteristics

MAIN L/R, REAR L/R (SPEAKER: SMALL) (H.P.F) .....	fc = 90 Hz, 12 dB/oct.
SUBWOOFER (L.P.F) .....	fc = 90 Hz, 18 dB/oct.

## VIDEO SECTION

### Video Signal Type

[U.K. and Europe models] .....	PAL
[China and General models] .....	NTSC/PAL

### Video Signal Level .....

1 Vp-p/75 ohms
----------------

### S-Video Signal Level

Y .....	1 Vp-p/75 ohms
C .....	0.286 Vp-p/75 ohms

### Maximum Input Level .....

1.5 Vp-p or more
------------------

### Signal-to-Noise Ratio .....

50 dB or more
---------------

### Monitor Out Frequency Response

.....	5 Hz to 10 MHz, -3 dB
-------	-----------------------

## GENERAL

### Power Supply

[U.K. and Europe models] .....	AC 230 V, 50 Hz
[China model] .....	AC 220 V, 50 Hz
[General model] .....	AC 110/120/220/240 V, 50/60 Hz

### Power Consumption

[U.K. and Europe models] .....	300 W
[China and General models] .....	310 W

### Maximum Power Consumption

[General model only] 5-ch, 10% THD .....	650 W
---	-------

### AC Outlets

3 SWITCHED OUTLETS [China and General models] .....	100 W max. total
2 SWITCHED OUTLETS [Europe model] .....	100 W max. total
1 SWITCHED OUTLET [U.K. model] .....	100 W max.

### Dimensions (W x H x D)

.....	435 x 151 x 391 mm (17-1/8" x 5-15/16" x 15-3/8")
-------	--

### Weight .....

12.5 kg (27 lbs. 8 oz.)
-------------------------

### Accessories .....

Remote control Batteries
-----------------------------

Specifications are subject to change without notice.

**LIST OF MANUFACTURERS' CODES  
LISTES DES CODES FABRICANT  
VERZEICHNIS DER HERSTELLER CODES  
LISTA ÖVER TILLVERKARKODER  
ELENCO DEI CODICI DEL FABBRICANTE  
LISTA DE CÓDIGOS DE FABRICANTES  
LIJST VAN CODES VAN FABRIKANT**

**TV**

Abex	0032	Crystal	0431	Hypson	0037, 0282, 0264
Acura	0009	Curtis Mathes	0093	ICE	0217, 0371, 0264
Admiral	0093, 0163, 0213	Cybertron	0218	ICeS	0218
Adyson	0217, 0032	Daewoo	0037, 0374, 0009	ITS	0371
Akai	0208, 0361	Dainichi	0218, 0215	ITT	0163, 0361
Akura	0218, 0264, 0369	Dansai	0037	Imperial	0370, 0418, 0074, 0076, 0084, 0247
Alaron	0216	Dayton	0009	Indiana	0037
Alba	0037, 0218, 0371, 0009, 0036, 0235	De Graaf	0208	Ingelen	0163
Allorgan	0294	Decca	0037, 0072	Inno Hit	0072
Amplivision	0217	Dixi	0037, 0009	Interbuy	0068
Amstrad	0371, 0009, 0362, 0369	Dual	0336, 0352	Interfunk	0037, 0163, 0247, 0361
Anam	0009, 0068	Dual Tec	0217	Intervision	0037, 0217, 0264, 0102, 0068
Anitech	0009, 0068, 0076	Dumont	0070	Isukai	0218
Arcam	0216, 0217	Elbe	0259	JVC	0371, 0036, 0053, 0190, 0192
Asberg	0076	Elin	0037	KTV	0217
Asuka	0218	Elite	0218, 0320	Kaisui	0216, 0217, 0218, 0009, 0282
Atlantic	0206	Elta	0009	Kamp	0216
Audiosonic	0037, 0109	Emerson	0282, 0213, 0361	Kapsch	0206, 0163
Autovox	0206, 0076, 0336	Erres	0037, 0012	Kawasho	0216
BPL	0282	Expert	0206	Kendo	0037, 0235, 0362
BSR	0294	Ferguson	0037, 0109, 0005, 0073, 0190, 0238, 0287, 0335, 0343	Kingsley	0216
BTC	0218	Fidelity	0216, 0361	Kneissel	0259
Baird	0343	Finlandia	0208, 0346, 0359	Korpel	0037
Basic Line	0218, 0009	Finlux	0037, 0072, 0070, 0105, 0346	Koyoda	0009
Baur	0037, 0010, 0554, 0349, 0361	Firstline	0216, 0217, 0294, 0009, 0321, 0247	Leyco	0037, 0294, 0072, 0264
Beko	0370	Fisher	0370, 0217, 0208, 0303	Liesenk & Tter	0037
Beon	0037	Flint	0455	Lloytron	0032
Binatone	0217	Formenti	0037, 0320, 0213	Loewe	0075
Blaupunkt	0554, 0191, 0195, 0200, 0213, 0327, 0328	Frontech	0264, 0431, 0163, 0247	Luma	0206
Blue Sky	0218	Fujitsu	0072, 0206	Luxor	0349, 0361
Blue Star	0282	Funai	0294, 0264, 0303	M Electronic	0037, 0217, 0374, 0009, 0109, 0068, 0105, 0163, 0287, 0346
Bondstec	0247	GE	0282, 0093	MGA	0150
Boots	0217	GEC	0037, 0217, 0072, 0043, 0205	MTC	0216, 0349
Brandt	0109, 0196, 0198, 0205, 0333, 0335	GPM	0218	Magnadyne	0102, 0247
Briovega	0362	Geloso	0009, 0213	Magnafon	0102, 0076, 0213
Britannia	0216	Genexxa	0218, 0163	Magnavox	0036
Bush	0037, 0218, 0374, 0371, 0294, 0009, 0282, 0036, 0349	GoldStar	0037, 0217, 0109, 0032, 0290	Manesth	0217, 0320, 0264, 0235
CCE	0037, 0217	Goodmans	0037, 0217, 0374, 0371, 0072, 0036, 0235, 0317, 0343	Marantz	0037
CGE	0074, 0076, 0084, 0247, 0306	Gorenje	0370	Mark	0037
CS Electronics	0216	Gradiente	0053	Matsui	0037, 0217, 0371, 0294, 0009, 0072, 0036, 0035, 0011, 0208, 0235
CTC	0247	Graetz	0163, 0361	Matsushita	0250
Carrefour	0036	Granada	0037, 0217, 0072, 0146, 0208, 0339, 0359	McMichael	0043
Cascade	0009	Grandin	0282	Mediator	0037, 0012
Cathay	0037	Grundig	0037, 0554, 0070, 0191, 0195, 0205	Memorex	0009, 0250, 0150
Centurion	0037	HCM	0009, 0282	Memphis	0337
Century	0213	Hanseatic	0037, 0320, 0361	Metz	0213, 0367
Cimline	0009	Harley Davidson	0043	Midland	0032
Clarivox	0037	Harvard	0068	Minerva	0554, 0070
Clatronic	0370, 0076, 0247	Hinari	0037, 0218, 0009, 0036	Minoka	0369
Condor	0370, 0320	Hisawa	0282, 0455	Mitsubishi	0036, 0093, 0108, 0150
Contec	0216, 0009, 0036, 0157	Hitachi	0217, 0036, 0109, 0032, 0043, 0044, 0105, 0163, 0196, 0198, 0225, 0306, 0349	Mivar	0216, 0290, 0291, 0292
Continental Edison	0196, 0198, 0205, 0333	Huanyu	0216, 0374	Motion	0076
Crosley	0074, 0076, 0084, 0213			Motorola	0093
Crown	0037, 0370, 0418, 0009, 0076			Multitech	0216, 0217, 0009, 0102, 0076

NEC	0455, 0036	Sanyo	0072, 0036, 0011, 0146, 0157,
NEI	0037, 0431, 0337		0208, 0213, 0339
Neckermann	0037, 0554, 0191, 0213, 0349	Schaub Lorenz	0361
Nikkai	0037, 0216, 0218, 0072,	Schneider	0037, 0218, 0371, 0247,
	0264, 0035, 0032, 0337		0303, 0323, 0336, 0352
Nikko	0317	Sears	0146
Nobliko	0102, 0076	Sei-Sinudyne	0010
Nokia	0361	Seleco	0206, 0163, 0259, 0362
Nordmende	0109, 0196, 0198,	Sentra	0035
	0213, 0287, 0343	Sharp	0036, 0093, 0157
Oceanic	0163, 0215, 0361	Shorai	0294
Optimus	0250	Siarem	0102, 0213
Optonica	0093	Siemens	0037, 0554, 0157, 0191, 0195,
Orion	0037, 0294, 0320, 0321, 0235		0200, 0213, 0327, 0328
Osaki	0217, 0218, 0072, 0264, 0032	Silver	0036
Oso	0218	Sinudyne	0294, 0102, 0213, 0235
Osume	0072, 0032, 0157	Solavox	0032, 0163
Otake	0317	Sonitron	0208
Otto Versand	0037, 0217, 0320, 0036,	Sonoko	0037, 0009
	0010, 0554, 0191, 0213,	Sonolor	0163, 0208, 0215
	0343, 0349	Sontec	0037
Palladium	0370, 0418	Sony	0036, 0010, 0011
Panama	0217, 0264	Soundwave	0037, 0418
Panasonic	0250, 0163, 0213, 0214,	Standard	0217, 0218, 0009
	0226, 0367	Stern	0206, 0163, 0259
Pathe Cinema	0216, 0320, 0213, 0238	Sunkai	0294, 0321
Pathe Marconi	0196, 0198, 0205, 0333	Susumu	0218
Pausa	0009	Sysline	0037
Penney	0032	Tandy	0217, 0218, 0072, 0093, 0163
Perdio	0320	Tashiko	0217, 0036, 0043, 0359
Phase	0032	Tatung	0037, 0217, 0072
Philco	0074, 0076, 0084, 0213, 0247	Tec	0217, 0247
Philips	0037, 0374, 0554, 0012,	Technema	0320
	0043, 0323	Technics	0250
Phonola	0037, 0012	Teknika	0150
Pioneer	0109, 0163, 0287	Teleavia	0205, 0333, 0343
Profex	0009, 0076, 0361	Telefunken	0109, 0005, 0074, 0084,
Proline	0321		0101, 0213, 0262, 0306,
Protech	0037, 0217, 0418, 0009, 0264,		0335, 0343
	0102, 0431, 0247, 0337	Telemeister	0320
Pye	0012	Teletech	0009
Quasar	0250	Teleton	0217, 0206, 0349
Quelle	0037, 0010, 0554, 0011, 0070,	Tensai	0218, 0294, 0320, 0317
	0074, 0084, 0200, 0213,	Texet	0216, 0218
	0306, 0327, 0328, 0361	Thomson	0109, 0196, 0198, 0205,
Questa	0036		0287, 0333, 0343, 0349
R-Line	0037	Thorn	0037, 0072, 0035, 0074,
RBM	0070		0084, 0190, 0192, 0361
RCA	0090, 0093	Thorn-Ferguson	0343
Radio Shack	0032	Tomashi	0282
Radiola	0037, 0012, 0323	Toshiba	0036, 0035, 0070, 0243
Rank Arena	0036	Trical	0157
Realistic	0032	Triumph	0243
Rediffusion	0361	Uher	0206, 0320, 0303
Revox	0037	Ultra	0192
Rex	0206, 0264, 0163, 0259	Ultravox	0102
Rhapsody	0216	Universum	0037, 0370, 0264, 0105, 0346
Roadstar	0218, 0418, 0009, 0264	Vestel	0037
SBR	0037, 0012, 0043	Victor	0053
SEG	0217, 0264, 0036, 0076	Videosat	0247
SEI	0294, 0102, 0213	Videotechnic	0217
Saba	0109, 0075, 0163, 0196, 0198,	Vidtech	0036
	0205, 0213, 0287, 0335, 0343	Vision	0320
Saccs	0238	Voxson	0163
Saisho	0009, 0264, 0431, 0011, 0235	Waltham	0217
Salora	0163, 0349, 0359, 0361	Watson	0037, 0320
Sambers	0102, 0076, 0213	Watt Radio	0102
Sampo	0032	Wega	0036
Samsung	0037, 0370, 0217, 0009,	White Westinghouse	0037, 0216, 0320
	0264, 0032, 0090, 0290	Yoko	0037, 0217, 0264, 0431
Sandra	0216	Zanussi	0206

## CABLE

ABC	1003, 1008, 1014, 1017
Birmingham Cable Communications	1276
British Telecom	1003, 1105
Cabletime	1161, 1271, 1377
Clyde	1086
Contec	1019
Decsat	1423
Filmnet	1443
France Telecom	1451
GEC	1086
General Instrument	1276
GoldStar	1144
Jerrold	1003, 1276, 1014
MNet	1443, 1019
Magnavox	1032
Memorex	1000
Movie Time	1156
NSC	1156
Oak	1019
PVP Stereo Visual Matrix	1003
Panasonic	1000
Paragon	1000
Pioneer	1144, 1260
Pulsar	1000
Runco	1000
STS	1156
Salora	1382
Samsung	1144
Satbox	1375
Scientific Atlanta	1008, 1277, 1017
Starcom	1003
Tele+1	1443
Teleservice	1281
Toshiba	1000
Tudi	1286
United Cable	1003
Videoway	1250
Westminster	1105
Zenith	1000

## DBS TUNER

AST	2321, 2351
Alba	2455, 2421, 2362, 2613
Aldes	2288
Allantide	2333
Amstrad	2080, 2252, 2345, 2461, 2501
Ankaro	2369, 2288, 2220, 2519, 2217
Anttron	2421, 2183
Arcon	2368
Armstrong	2243
Astra	2108, 2539
Astro	2520, 2173, 2358, 2501
Avalon	2396
Axis	2369, 2530
BT	2668
Barcom	2217
Beko	2189
Best	2369, 2217
Blaupunkt	2173
Boca	2243, 2513
Brain Wave	2332
Bush	2067
CNT	2520
Cambridge	2344
Channel Master	2362
Chaparral	2053, 2209

CityCom	2394	Palcom	2297	Amstrad	3000, 3278, 3325, 3332
Commlink	2288	Palladium	2571	Anitech	3072
Connexions	2396	Palsat	2501	Asha	3240
Crown	2243	Panda	2455	Asuka	3037
Cyrus	2200	Philips	2455, 2571, 2200, 2292, 2328	Audiovox	3037
D-box	2723	Phonotrend	2288, 2592	Baird	3000, 3041, 3104, 3107
DDC	2362	Planet	2871	Basic Line	3072, 3020, 3278
DNT	2396, 2200	Plasmatic	2442	Beaumarck	3240
Diskxpress	2217	Polytron	2394	Bell & Howell	3104
Drake	2268	Promax	2455	Blaupunkt	3034, 3226, 3195, 3003, 3006, 3154, 3162, 3227, 3403
EIF	2417	Prosat	2288	Brandt	3320, 3187, 3321
Echostar	2396, 2871	RQDral	2362, 2519	Brandt Electronic	3041
Emanon	2421	RFT	2288, 2220, 2200	Broksonic	3209
FTE	2331	Radiola	2200	Bush	3072, 3278, 3209, 3352
Ferguson	2183, 2067, 2189, 2336	Radix	2396, 2882	CCE	3072, 3278
Fidelity	2252	SAT	2321, 2351, 2461	CGE	3000
Finlux	2455, 2108, 2344, 2397	SEG	2421, 2369, 2539	Calix	3037
Fracarro	2871	STVI	2417	Capehart	3020
Freecom	2421, 2335	Saba	2520, 2336	Carver	3081
Fuba	2421, 2369, 2396, 2217, 2297, 2417	Sabre	2455	Catron	3020
G-Sat	2183	Sagem	2820	Cimline	3072
Galaxis	2288, 2834, 2863	Salora	2108	Cineral	3278
Galaxisat	2321	Samsung	2287	Citizen	3037, 3278
GoldStar	2335	SatPartner	2421, 2332, 2520, 2502, 2335, 2692	Clatronic	3020
Gooding	2571	Satcom	2605, 2346	Colt	3072
Goodmans	2189	Satec	2183, 2328	Combitech	3352
Grothusen	2335	Satmaster	2346	Condor	3020
Grundig	2571, 2173, 2189, 2328	Schwaiger	2183, 2394, 2504	Craig	3072, 3037, 3047, 3240
Harting und Helling	2333	Seemann	2396, 2530	Crown	3072, 3020, 3278
Hinari	2183	Siemens	2173	Curtis Mathes	3041, 3162
Hirschmann	2502, 2173, 2573, 2287, 2333, 2397, 2398	Skymaster	2288, 2605, 2519	Cybernex	3240
Hitachi	2455	Star Trak	2421	Cyrus	3081
Houston	2668	Strong	2421	Daewoo	3020, 3278, 3045
Huth	2243, 2288, 2220, 2346	Sunstar	2513	Dansai	3072
ITT	2108	TPS	2820	Daytron	3020
InVideo	2871	Tantec	2455, 2297, 2336	De Graaf	3042, 3166
Intervision	2592	TechniSat	2262, 2501	Decca	3000, 3081
JVC	2571	Techniland	2346	Denon	3042
Johansson	2332	Telefunken	2421	Dual	3041
Kathrein	2173, 2200, 2092, 2331, 2358, 2394, 2442, 2480, 2504	Teleka	2243, 2613	Dumont	3000, 3081, 3104
Kosmos	2331, 2335	Telesat	2605	Dynatech	3000
Kreiselmeyer	2173	Thomson	2455	ESC	3278, 3240
Kyostar	2421	Tonna	2668, 2346	Elbe	3038
La Sat	2520, 2513, 2464	Triad	2321, 2333, 2335, 2351	Elcatech	3072
Lemon	2692	Triasat	2501	Electrohome	3037
Lenco	2421, 2335	Unitor	2332, 2217	Electroponic	3037
Lennox	2592	Universum	2571, 2173	Emerex	3032
Lupus	2369	Vector	2333	Emerson	3000, 3037, 3278, 3209, 3036, 3043, 3088
Luxor	2573, 2108	Ventana	2200	Ferguson	3320, 3041, 3107, 3321
Manhattan	2455, 2592, 2520	Vortec	2421	Fidelity	3000
Marantz	2200	Vtech	2351	Finlandia	3081, 3104
Maspro	2092, 2328, 2336	Wevasat	2333	Finlux	3000, 3081, 3042, 3104
Matsui	2571, 2344	Winersat	2332	Firstline	3072, 3037, 3209, 3045, 3043
Mediamarkt	2243	Wisi	2455, 2396, 2173, 2321, 2351, 2372, 2406, 2407	Fisher	3046, 3047, 3054, 3104
Micro Technology	2333, 2539	XSat	2889	Frontech	3020
Minerva	2571	Xcom Multimedia	2889	Fuji	3033
Morgan's	2243, 2513	Zehnder	2520, 2321, 2331	Funai	3000
Multistar	2331, 2464			GE	3048, 3240
Muratto	2335			GEC	3081
Navex	2332			Garrard	3000
Neuhaus	2501			General	3020
Neusat	2692, 2834			Go Video	3432
Newhaus	2220			GoldHand	3072
Nikko	2360			GoldStar	3037, 3038, 3225
Nokia	2455, 2573, 2108, 2328, 2397, 2873			Goodmans	3072, 3000, 3020, 3037, 3278, 3403
Nordmende	2362			Gradiente	3000, 3008
Orbitech	2501			Graetz	3005, 3041, 3104, 3240
Oxford	2344			Granada	3081, 3046, 3104
Pace	2455, 2183, 2067, 2328, 2336, 2791			Grandin	3072, 3000, 3037

## VCR

ASA	3037, 3081
Admiral	3048
Adventura	3000
Aiko	3278
Aiwa	3000, 3037, 3307, 3348, 3352
Akai	3315, 3106, 3041, 3053
Akiba	3072
Alba	3072, 3020, 3278, 3209, 3315, 3352
Ambassador	3020



Grundig	3072, 3081, 3347, 3226, 3195, 3003, 3006, 3007, 3207, 3349, 3403	Optimus	3037, 3432, 3048, 3104, 3162	Sunstar	3000
HCM	3072	Orion	3209, 3004, 3036, 3088, 3348, 3352	Suntronic	3000
HI-Q	3047	Osaki	3072, 3000, 3037	Sylvania	3000, 3081, 3043
Hanseatic	3037	Otto Versand	3081	Symphonic	3000
Harley Davidson	3000	Palladium	3072, 3037, 3006, 3041	TMK	3036, 3240
Harman/Kardon	3038	Panasonic	3226, 3162, 3225, 3227	Tashiko	3000
Harwood	3072	Pathe Cinema	3036	Tatung	3000, 3081, 3041
Headquarter	3046	Pathe Marconi	3041	Teac	3000, 3041
Hinari	3072, 3004, 3240, 3352	Penney	3037, 3042, 3038, 3054, 3240	Tec	3020
Hitachi	3000, 3004, 3042, 3041, 3166, 3235, 3240	Pentax	3042	Technics	3226, 3162
Hypson	3072	Perdio	3000	Teknika	3000, 3037
ITT	3106, 3046, 3384, 3005, 3041, 3104, 3240	Philco	3209, 3038	Teleavia	3041
ITV	3037, 3278	Philips	3081, 3384, 3403	Telefunken	3320, 3384, 3041, 3187, 3321
Imperial	3000	Phonola	3081	Tenosal	3072
Ingersol	3004	Pilot	3037	Tensai	3322, 3000
Interfunk	3081	Pioneer	3081, 3067, 3162, 3235	Thomas	3000
JVC	3067, 3384, 3008, 3041, 3206, 3207, 3486	Portland	3020	Thomson	3320, 3384, 3041
Jensen	3041	Profex	3322	Thorn	3036, 3041, 3104
KEC	3037, 3278	Profitronic	3240	Toshiba	3081, 3045, 3384, 3041, 3043
KLH	3072	Proline	3000	Totevision	3037, 3240
Kaisui	3072	Protec	3072	Towada	3322
Kendo	3209, 3106	Pye	3081	Uher	3240
Kenwood	3067, 3384, 3038, 3041	Quarter	3046	Unitech	3240
Kodak	3037	Quartz	3046	Universum	3000, 3037, 3081, 3106, 3195, 3006, 3240, 3325
Korpel	3072	Quasar	3162	Vector	3045
LXI	3037	Quelle	3081	Vector Research	3038
Lenco	3278	RCA	3106, 3042, 3048, 3240	Video Concepts	3045
Leyco	3072	RFT	3403	Videosonic	3240
Lloyd's	3000	Radio Shack	3000, 3037	Wards	3072, 3000, 3081, 3042, 3048, 3047, 3240
Loewe	3037, 3004, 3081, 3006	Radiola	3081	White Westinghouse	3278
Logik	3072, 3004, 3240	Radix	3037	XR-1000	3072, 3000
Luxor	3106, 3048, 3046, 3043, 3104	Randex	3037	Yamaha	3038
M Electronic	3000	Realistic	3000, 3037, 3048, 3046, 3047, 3104	Yamishi	3072
MGA	3043, 3240	Rex	3384, 3041	Yokan	3072
MGN Technology	3240	Ricoh	3034	Yoko	3020, 3240
MTC	3000, 3240	Roadstar	3072, 3037, 3278, 3240	Zenith	3000, 3033, 3034
Magnasonic	3278	SBR	3081		
Magnavox	3000, 3081	SEG	3322, 3240		
Magnin	3240	SEI	3004, 3081		
Manesth	3072, 3045	STS	3042		
Marantz	3081, 3003, 3006	Saba	3320, 3384, 3041, 3206, 3207, 3297, 3321		
Marta	3037	Saisho	3209, 3004, 3036, 3088		
Matsui	3209, 3004, 3036, 3088, 3348, 3352	Salora	3106, 3046, 3043		
Matsushita	3162	Samsung	3432, 3045, 3053, 3240		
Memorex	3000, 3037, 3048, 3046, 3047, 3104, 3162, 3240, 3307	Sanky	3048		
Memphis	3072	Sansui	3000, 3067, 3041		
Metz	3347, 3195, 3003, 3006, 3162, 3227	Sanyo	3046, 3047, 3104, 3240		
Minerva	3195, 3006	Saville	3352		
Minolta	3042	Schaub Lorenz	3000, 3005, 3041, 3104		
Mitsubishi	3081, 3067, 3048, 3043	Schneider	3072, 3000, 3081		
Motorola	3048	Scott	3045, 3043		
Multitech	3072, 3000	Sears	3000, 3037, 3042, 3046, 3047, 3054, 3104		
Murphy	3000	Seleco	3041		
NEC	3067, 3038, 3041, 3104	Semp	3045		
Neckermann	3081	Sentra	3020		
Nesco	3072	Sharp	3048		
Nikko	3037	Shintom	3072, 3104		
Nikon	3034	Shogun	3240		
Noblex	3240	Shorai	3004		
Nokia	3106, 3046, 3041, 3104, 3240	Siemens	3037, 3081, 3195, 3003, 3006, 3054, 3104		
Nordmende	3320, 3384, 3041, 3297, 3321	Silva	3037		
Oceanic	3000, 3041	Singer	3072, 3045		
Okano	3315, 3348	Sinudyne	3004, 3081		
Olympus	3226	Solavox	3020		
		Sonolor	3046		
		Sontec	3037		
		Sony	3000, 3032, 3033, 3034, 3011		
		Sunkai	3348		

---

## DVD PLAYER

Kenwood	4534
Magnavox	4503
Onkyo	4503
Panasonic	4490
Philips	4539, 4503
Pioneer	4525
Sony	4533
Technics	4490
Thomson	4551
Toshiba	4503
Yamaha	4490, 4545
Zenith	4503

---

## LD PLAYER

Aiwa	5203
Carver	5064, 5194
Cyrus	5388
Denon	5059, 5172
Disco Vision	5023
Funai	5203
Hitachi	5023
Magnavox	5194, 5217
Marantz	5064, 5194
Mitsubishi	5059
NAD	5059
Panasonic	5204, 5496
Philips	5064, 5388, 5194
Pioneer	5023, 5059

Quasar 5204  
 Radiola 5388  
 Realistic 5203  
 Salora 5064  
 Sega 5023  
 Sharp 5001  
 Sony 5193, 5201  
 Technics 5204, 5496  
 Telefunken 5059  
 Theta Digital 5194  
 Thorn 5014  
 Yamaha 5217

---

## CD PLAYER

Aiwa 6124, 6157, 6419  
 Akai 6108, 6156, 6199  
 Alba 6536, 6288, 6334  
 Arcam 6157  
 Audio Research 6157  
 Audio Ton 6157  
 Audiolab 6157  
 Audiomeca 6157  
 BSR 6134  
 Bestar 6164  
 Binatone 6452  
 California Audio Lab 6029  
 Carver 6157, 6179  
 Condor 6134, 6164  
 Cyrus 6157  
 DKK 6000  
 Denon 6003, 6034  
 Dual 6196  
 Emerson 6164  
 Fisher 6048, 6179, 6342  
 GE 6334  
 Genexxa 6032, 6164  
 GoldStar 6525, 6383  
 Goodmans 6536  
 Grundig 6157  
 Harman/Kardon 6108, 6173  
 Hitachi 6032, 6291  
 JVC 6072  
 Kenwood 6037, 6523, 6028,  
 6048, 6190  
 Kodak 6287  
 Krell 6157  
 Linn 6157

Luxman 6328  
 M Electronic 6525  
 MCS 6029  
 Magnavox 6157, 6038, 6129  
 Marantz 6157, 6029, 6038, 6129  
 Matsui 6157, 6288, 6307  
 McIntosh 6287  
 Memorex 6032, 6164  
 Meridian 6157  
 Micromega 6157  
 Mission 6157  
 Mitsubishi 6108, 6156  
 NAD 6000  
 NSM 6157  
 Naim 6157  
 Nikko 6525, 6164  
 Onkyo 6101, 6102  
 Optimus 6000, 6032, 6037, 6536,  
 6048, 6179, 6196, 6342  
 Panasonic 6303, 6029, 6367  
 Philips 6157, 6274, 6287  
 Pioneer 6032  
 Poppy 6164  
 Proton 6157  
 QED 6157  
 Quad 6157  
 Quasar 6029  
 RCA 6179  
 Realistic 6164, 6179  
 Revox 6157, 6113  
 Roadstar 6461, 6525, 6527  
 Rotel 6157  
 SAE 6157  
 Sansui 6157, 6202, 6513  
 Sanyo 6048, 6179, 6342  
 Schneider 6134  
 Scott 6164  
 Sharp 6037, 6262, 6265  
 Sherwood 6114, 6196  
 Siemens 6516  
 Signature 6108  
 Sony 6000, 6490  
 Teac 6378  
 Technics 6207, 6303, 6029  
 Toshiba 6481  
 Universum 6157  
 Victor 6072  
 Wards 6157, 6108  
 Yamaha 6036, 6082, 6187, 6712  
 Yorx 6461

---

## MD RECORDER

Kenwood 7826  
 Sony 7490  
 Yamaha 7888, 7490

---

## TAPE DECK

Aiwa 8029, 8197, 8200  
 Akai 8188, 8189  
 Arcam 8076  
 Carver 8029  
 Denon 8076, 8412  
 Fisher 8074  
 Grundig 8029  
 Harman/Kardon 8182  
 JVC 8244, 8273, 8274  
 Kenwood 8070, 8071, 8092,  
 8205, 8233, 8234  
 Magnavox 8029  
 Marantz 8029, 8009  
 Memorex 8099, 8101  
 Mitsubishi 8189  
 Onkyo 8136, 8135  
 Optimus 8027, 8220  
 Panasonic 8229  
 Philips 8029  
 Pioneer 8027, 8099, 8101, 8220  
 Revox 8029  
 Sansui 8029, 8009  
 Sanyo 8074  
 Sharp 8205  
 Sony 8170, 8243  
 Technics 8229  
 Victor 8273, 8274  
 Wards 8027  
 Yamaha 8094, 8097, 8205, 8478, 8524



---

**YAMAHA ELECTRONICS CORPORATION, USA** 6660 ORANGETHORPE AVE., BUENA PARK, CALIF. 90620, U.S.A.  
**YAMAHA CANADA MUSIC LTD.** 135 MILNER AVE., SCARBOROUGH, ONTARIO M1S 3R1, CANADA  
**YAMAHA ELECTRONIK EUROPA G.m.b.H.** SIEMENSSTR. 22-34, 25462 RELLINGEN BEI HAMBURG, F.R. OF GERMANY  
**YAMAHA ELECTRONIQUE FRANCE S.A.** RUE AMBROISE CROIZAT BP70 CROISSY-BEAUBOURG 77312 MARNE-LA-VALLEE CEDEX02, FRANCE  
**YAMAHA ELECTRONICS (UK) LTD.** YAMAHA HOUSE, 200 RICKMANSWORTH ROAD WATFORD, HERTS WD1 7JS, ENGLAND  
**YAMAHA SCANDINAVIA A.B.** J A WETTERGRENS GATA 1, BOX 30053, 400 43 VÄSTRA FRÖLUNDA, SWEDEN  
**YAMAHA MUSIC AUSTRALIA PTY, LTD.** 17-33 MARKET ST., SOUTH MELBOURNE, 3205 VIC., AUSTRALIA

**YAMAHA CORPORATION**  
Printed in Malaysia ID V403430

# Quick Reference Card

## AMP/TUN

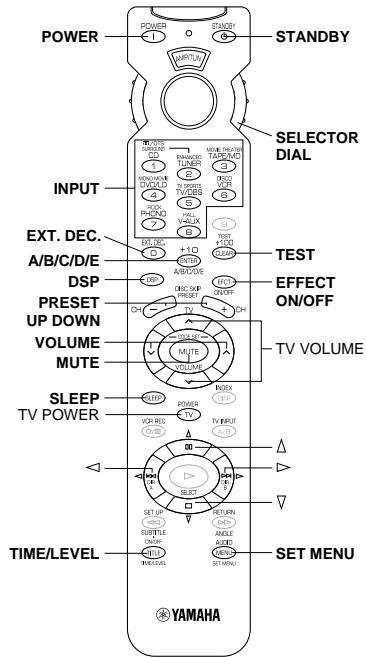

## TAPE/MD

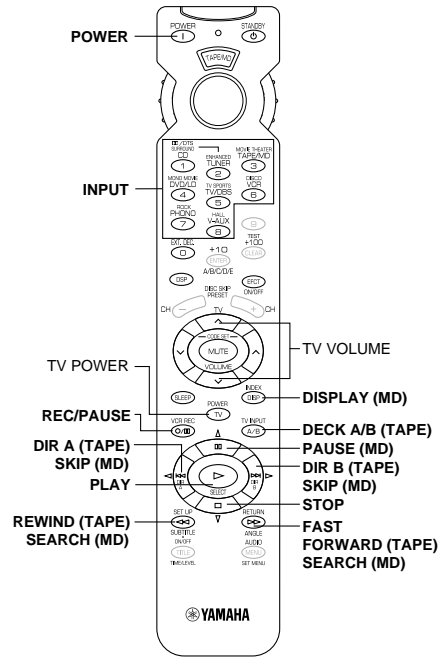

## CD

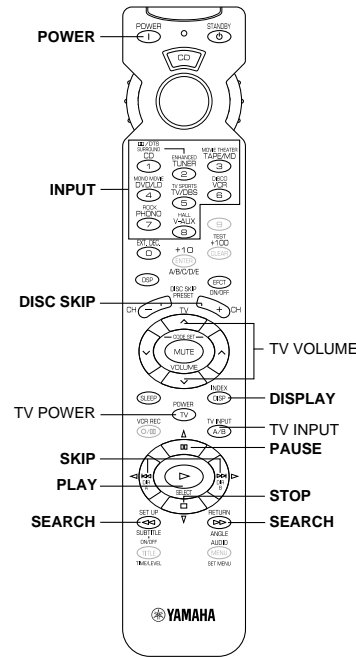



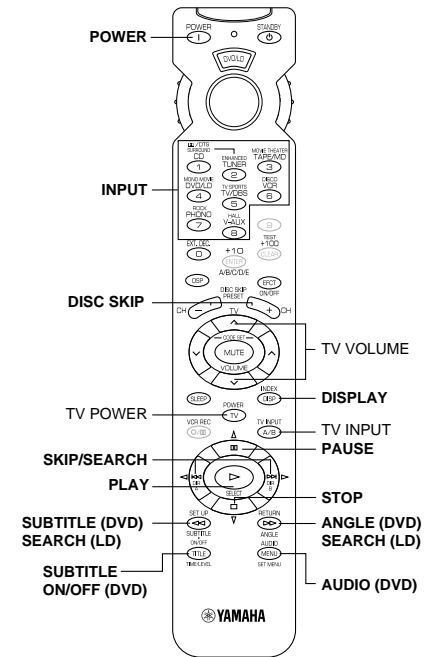

## DVD/LD

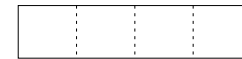
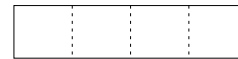
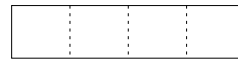
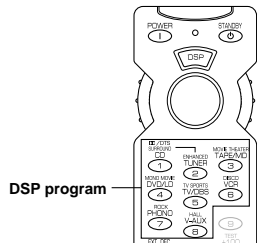

## DSP

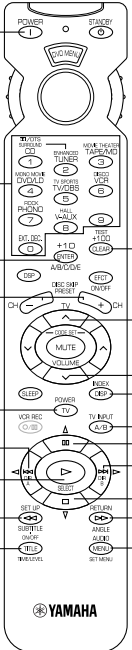
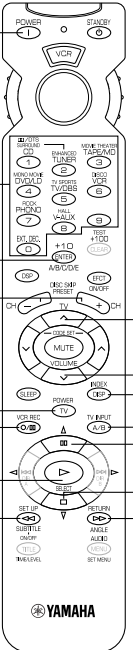
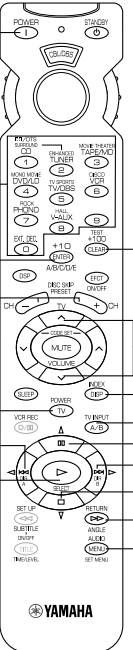
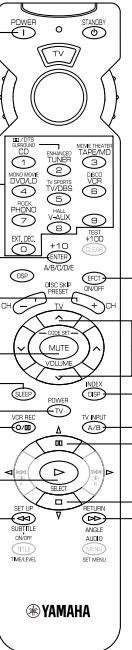

# Quick Reference Card

DVD MENU	VCR	CBL/DBS	TV
 <p><b>POWER</b> (POWER, STANDBY)</p> <p><b>Numeric buttons</b> (1-9, 0, *, #)</p> <p><b>+10</b> (+10, +100)</p> <p><b>DISC SKIP</b> (SKIP, CH)</p> <p><b>TV VOLUME</b> (MUTE, VOLUME)</p> <p><b>TV POWER</b> (SLEEP, POWER, TV, TV MUTE, A/B)</p> <p><b>MENU LEFT</b> (LEFT, MENU)</p> <p><b>MENU SELECT</b> (ENTER, MENU)</p> <p><b>SET UP</b> (SET UP, TV, TV MUTE, A/B)</p> <p><b>TITLE</b> (TITLE, TV, TV MUTE, A/B)</p> <p><b>YAMAHA</b></p>	 <p><b>POWER</b> (POWER, STANDBY)</p> <p><b>CHANNEL</b> (1-9, 0, *, #)</p> <p><b>CHANNEL ENTER</b> (ENTER, CH)</p> <p><b>CHANNEL UP DOWN</b> (UP, DOWN, CH)</p> <p><b>TV VOLUME</b> (MUTE, VOLUME)</p> <p><b>TV POWER</b> (SLEEP, POWER, TV, TV MUTE, A/B)</p> <p><b>VCR REC (*1)</b> (VCR REC, TV, TV MUTE, A/B)</p> <p><b>PLAY</b> (PLAY, TV, TV MUTE, A/B)</p> <p><b>REWIND</b> (REWIND, TV, TV MUTE, A/B)</p> <p><b>YAMAHA</b></p>	 <p><b>POWER</b> (POWER, STANDBY)</p> <p><b>CHANNEL</b> (1-9, 0, *, #)</p> <p><b>CHANNEL ENTER</b> (ENTER, CH)</p> <p><b>CHANNEL UP DOWN</b> (UP, DOWN, CH)</p> <p><b>TV VOLUME</b> (MUTE, VOLUME)</p> <p><b>TV POWER</b> (SLEEP, POWER, TV, TV MUTE, A/B)</p> <p><b>MENU LEFT</b> (LEFT, MENU)</p> <p><b>MENU SELECT</b> (ENTER, MENU)</p> <p><b>DISPLAY</b> (DISPLAY, TV, TV MUTE, A/B)</p> <p><b>PAUSE</b> (PAUSE, TV, TV MUTE, A/B)</p> <p><b>STOP</b> (STOP, TV, TV MUTE, A/B)</p> <p><b>FAST FORWARD</b> (FAST FORWARD, TV, TV MUTE, A/B)</p> <p><b>RECALL</b> (RECALL, TV, TV MUTE, A/B)</p> <p><b>MENU</b> (MENU, TV, TV MUTE, A/B)</p> <p><b>YAMAHA</b></p>	 <p><b>POWER</b> (POWER, STANDBY)</p> <p><b>CHANNEL</b> (1-9, 0, *, #)</p> <p><b>CHANNEL ENTER</b> (ENTER, CH)</p> <p><b>CHANNEL UP DOWN</b> (UP, DOWN, CH)</p> <p><b>TV VOLUME</b> (MUTE, VOLUME)</p> <p><b>TV EFFECT ON/OFF</b> (TV EFFECT, TV, TV MUTE, A/B)</p> <p><b>TV MUTE</b> (MUTE, TV, TV MUTE, A/B)</p> <p><b>TV SLEEP</b> (SLEEP, TV, TV MUTE, A/B)</p> <p><b>TV POWER</b> (SLEEP, POWER, TV, TV MUTE, A/B)</p> <p><b>VCR REC (*1)</b> (VCR REC, TV, TV MUTE, A/B)</p> <p><b>VCR PLAY</b> (PLAY, TV, TV MUTE, A/B)</p> <p><b>VCR REWIND</b> (REWIND, TV, TV MUTE, A/B)</p> <p><b>VCR STOP</b> (STOP, TV, TV MUTE, A/B)</p> <p><b>VCR FAST FORWARD</b> (FAST FORWARD, TV, TV MUTE, A/B)</p> <p><b>YAMAHA</b></p>
			

\*1: Press this button twice to start recording.  
 Appuyer deux fois sur cette touche pour démarrer l'enregistrement.  
 Diese Taste zweimal drücken, um die Aufnahme zu starten.  
 Tryck två gånger på denna knapp för att starta inspelningen.

Premere due volte questo tasto per iniziare la registrazione.  
 Presione dos veces este botón para empezar a grabar.  
 Druk tweemaal op deze toets om met opnemen te beginnen.  
 按两次该按钮即可开始录像。