



Front Surround System

ATS-4080

Owner's Manual

• Read the supplied booklet "Safety Brochure" before using the unit.

CONTENTS

NOTICE AND INFORMATION 4

BEFORE USING THE UNIT 6

Features..... 6

Accessories..... 9

Using the remote control..... 9

Part names and functions..... 11

PREPARATION 17

1 Installation..... 17

Installing the center unit on a TV stand, etc..... 17

2 Connecting a TV..... 18

Connecting a TV that supports Audio Return Channel (ARC)..... 18

Connecting a TV that does not support Audio Return Channel (ARC)..... 19

3 Connecting playback devices..... 20

HDMI connection with a playback device..... 20

Analog connection with a playback device..... 20

4 Connecting the power cord..... 21

Connecting the power cord..... 21

5 Connecting to a network..... 21

Network functions and the MusicCast CONTROLLER app..... 21

Wired network connections..... 22

Wireless network connections..... 23

Connecting with the MusicCast CONTROLLER app (registering the unit as a MusicCast-enabled device)..... 23

PLAYBACK 27

Basic operations..... 27

Basic procedure for playback..... 27

Enjoying your favorite sound..... 30

Playback with 3D surround sound..... 30

Playback with surround sound..... 30

Playback with 2-channel stereo sound..... 30

Playback of human voices clearly (clear voice)..... 31

Enjoying enhanced bass sound (bass extension)..... 31

Use of a Bluetooth® device..... 32

Listening to music stored on a Bluetooth® device..... 32

Useful features for playback..... 34

Using a TV's remote control to operate the unit (HDMI control)..... 34

Showing audio information and function settings..... 35

Registering favorites with the unit..... 36

Play music with AirPlay..... 37

Playing iTunes/iOS device music with AirPlay..... 37

Play music stored on a media server (computer or NAS).....	39
Playing music stored on a media server (computer or NAS).....	39
Listening to Internet radio.....	40
Selecting an Internet radio station.....	40
Bookmark an Internet station.....	40
Listening to streaming services.....	42
Listening to a streaming service.....	42
Play music stored on mobile devices.....	43
Playing songs stored on your mobile device.....	43

CONFIGURATIONS 44

Configuring various functions.....	44
Changing the brightness of the indicators (DIMMER).....	44
Configuring the HDMI control function.....	44
Configuring HDMI audio output.....	45
Setting the auto power standby function.....	46
Enabling/disabling touch panel control (child lock function).....	46
Using surround speakers (MusicCast Surround function).....	47
Enabling/disabling the network standby function.....	49
Enabling/disabling a wireless (Wi-Fi) connection.....	50
Enabling/disabling the Bluetooth function.....	50
Updating the unit's firmware.....	51
Pairing the center unit and subwoofer manually.....	52
Initializing the unit.....	53
Connecting to a network using the WAC function.....	53
Adjusting the levels of the speakers.....	54
Setting the dynamic range compression.....	55

APPENDIX 57

When any problem appears (General).....	57
When any problem appears (Power and system function).....	57
When any problem appears (Audio).....	60
When any problem appears (Bluetooth®).....	62
When any problem appears (Network trouble).....	63
Specifications.....	66
Specifications (ATS-CU4080).....	66
Specifications (NS-WSW43).....	69
Supported HDMI audio and video formats.....	70
Supported digital audio formats.....	71
Supported file formats.....	71
Information for qualified contractors or dealers.....	72
Mounting the center unit on a wall.....	72

NOTICE AND INFORMATION

Information

Indicates notes on instructions, restrictions on functions, and additional information that may be helpful.

Trademarks



Manufactured under license from Dolby Laboratories. Dolby, Dolby Audio, Pro Logic, Dolby Vision, and the double-D symbol are trademarks of Dolby Laboratories.



For DTS patents, see <http://patents.dts.com>.

Manufactured under license from DTS, Inc. DTS, the Symbol, DTS and the Symbol together, DTS Digital Surround, and DTS Virtual:X are registered trademarks or trademarks of DTS, Inc. in the United States and/or other countries.

© DTS, Inc. All Rights Reserved.



To control this AirPlay 2-enabled speaker, iOS 11.4 or later is required.

Use of the Works with Apple badge means that an accessory has been designed to work specifically with the technology identified in the badge and has been certified by the developer to meet Apple performance standards.

Apple, AirPlay, Apple TV, Apple Watch, iPad, iPad Air, iPad Pro, iPhone, Lightning, and iTunes are trademarks of Apple Inc., registered in the U.S. and other countries.

App StoreSM

App Store is a service mark of Apple Inc.



The terms HDMI, the HDMI Logo, and High-Definition Multimedia Interface are trademarks or registered trademarks of HDMI Licensing LLC in the United States and other countries.

x.v.ColorTM

"x.v.Color" is a trademark of Sony Corporation.

Windows[®]

Windows is a registered trademark of Microsoft Corporation in the United States and other countries.

Internet Explorer, Windows Media Audio and Windows Media Player are either registered trademarks or trademarks of Microsoft Corporation in the United States and/or other countries.

Android™ Google Play™

Android and Google Play are trademarks of Google LLC.



The Wi-Fi CERTIFIED™ Logo is a certification mark of Wi-Fi Alliance®. Wi-Fi and Wi-Fi CERTIFIED are registered trademarks of Wi-Fi Alliance®.



The Bluetooth® word mark and logos are registered trademarks owned by Bluetooth SIG, Inc. and any use of such marks by Yamaha Corporation is under license.

Blu-ray™

"Blu-ray Disc™", "Blu-ray™", and the logos are trademarks of the Blu-ray Disc Association.





MusicCast is a trademark or registered trademark of Yamaha Corporation.



Yamaha Eco-Label is a mark that certifies products of high environmental performance.

About content in this manual

- This manual is for the following readers:
 - the users of the unit
 - the constructor, builder and dealer that mount the unit on the wall
- This manual uses the following signal words for the important information:
 -  **WARNING**
This content indicates "risk of serious injury or death."
 -  **CAUTION**
This content indicates "risk of injury."
 - **NOTICE**
Indicates points that you must observe in order to prevent product failure, damage or malfunction and data loss, as well as to protect the environment.
 - **NOTE**
Indicates notes on instructions, restrictions on functions, and additional information that may be helpful.
- The illustrations and screens in this manual are for instructional purposes only.
- The company names and product names in this manual are the trademarks or registered trademarks of their respective companies.
- Software may be revised and updated without prior notice.
- In this manual, iOS and Android mobile devices are collectively referred to as "mobile devices". The specific type of mobile device is noted in explanations as needed.

BEFORE USING THE UNIT

Features

Introduction

This front surround system allows for the enjoyment of dynamic sound with video played on a TV.

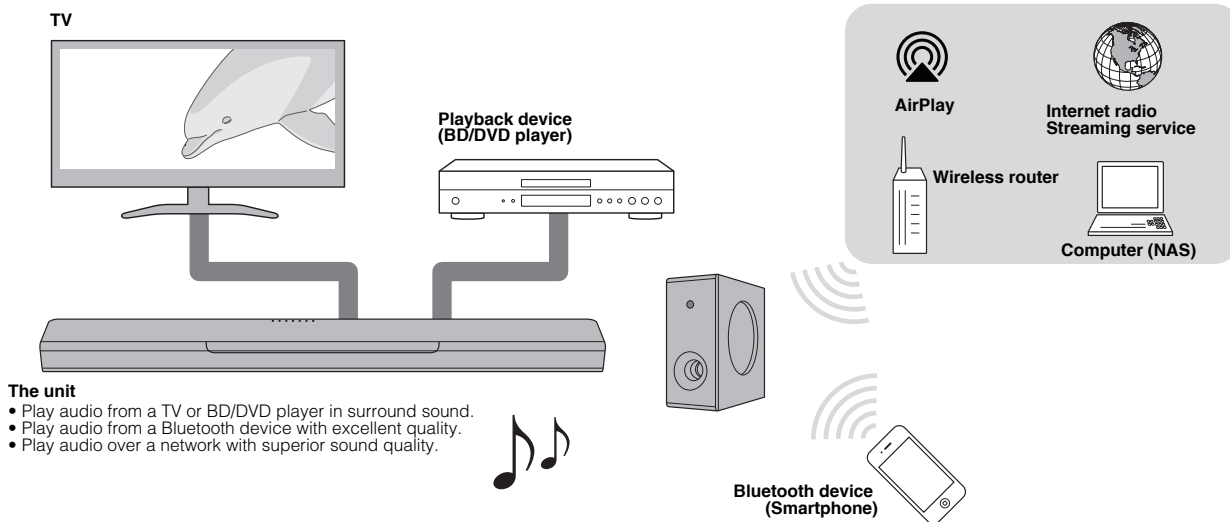

3D surround playback

Surround sound can be heard not only from horizontal directions, but also from varying heights when DTS Virtual:X is used. For details, see the following:

- “Playback with 3D surround sound” (p.30)

Transmission of 4K high dynamic range (HDR) video

Enjoy high-resolution video from a cable or satellite set top box, or a BD/DVD player. For details, see the following:

- “Supported HDMI audio and video formats” (p.70)

HDMI control function

Link functions of a TV and the unit are available using the TV's remote control. When a TV that supports Audio Return Channel (ARC) is used, this ARC-compatible unit can be connected to the TV via a single HDMI cable. For details, see the following:

- “Using a TV's remote control to operate the unit (HDMI control)” (p.34)
- “Connecting a TV that supports Audio Return Channel (ARC)” (p.18)

Support for playback of Bluetooth devices

Easily play content from a Bluetooth-compatible smartphone, tablet, or computer. In addition, our exclusive Compressed Music Enhancer technology improves sound quality and characteristics, and can be used to enjoy realistic and impressive sound. For details, see the following:

- “Listening to music stored on a Bluetooth® device” (p.32)

Unrestricted playback of music using MusicCast

Audio from a server, Internet radio, or streaming services can be played on this unit. In addition, the unit can distribute content to other MusicCast-enabled devices for synchronized playback.

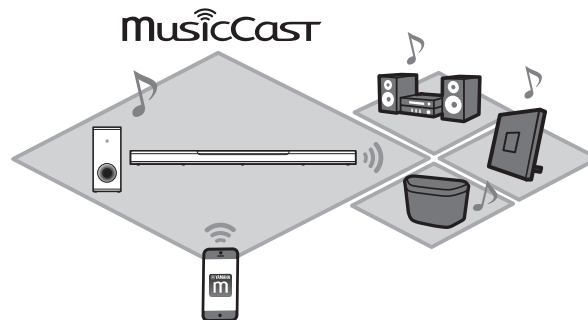

The MusicCast CONTROLLER app can be used to perform such tasks as selecting the input source or song and adjusting volume. For details, see the following:

- “Network functions and the MusicCast CONTROLLER app” (p.21)

Visit the Yamaha website for more information.

Bass extension

The bass extension function boosts low bass levels to enjoy more powerful sound. For details, see the following:

- “Enjoying enhanced bass sound (bass extension)” (p.31)

Clear voice

The clear voice function makes speech, such as dialog and narration, clearer. For details, see the following:

- “Playback of human voices clearly (clear voice)” (p.31)

Accessories

Checking the accessories

Make sure you have received all of the following accessories.



Center unit (ATS-CU4080)



Remote control
* A CR2025 Lithium battery has already been inserted into the remote control.



Wireless subwoofer (NS-WSW43)
In this manual, the wireless subwoofer is referred to as "subwoofer".



Power cord x 2



Optical digital audio cable



Quick Start Guide



Safety Brochure



Mounting template
* Use when mounting the center unit on a wall.

Using the remote control

Preparing the remote control

Remove the battery's insulating strip before attempting to use the remote control.

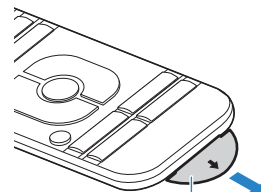

Battery's insulating strip

Operating range of the remote control

Operate the remote control within the range shown in the following figure.

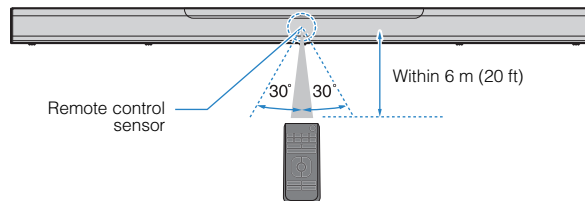

Replacing the battery in the remote control

Press and hold the release tab firmly in the direction indicated by [A], and slowly slide the battery holder out in the direction indicated by [B].

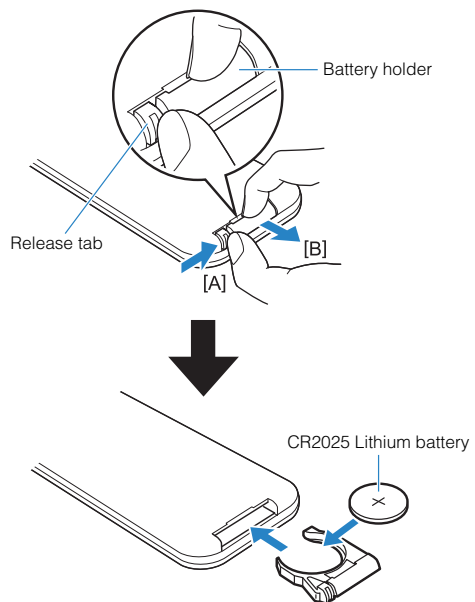

Part names and functions

Part names and functions of the front/top panel

The part names and functions of the front and top panels are as follows.

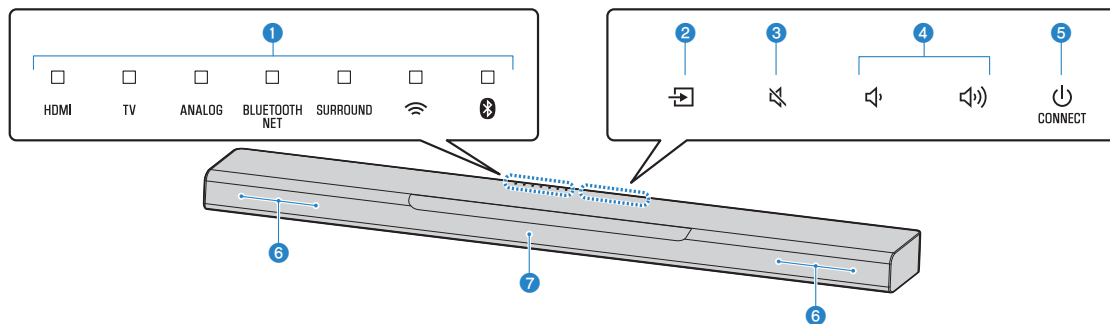

1 Indicators

The indicators on the top panel flash or glow, to show the operation and setting status. In this manual, indicators status, such as off, glowing, and flashing, are shown as the illustrations below.

Off

Glows

Flashes

NOTE

The brightness of the indicators can be changed using DIMMER on the remote control. For details, see the following:

- “Changing the brightness of the indicators (DIMMER)” (p.44)

2 (input)

Select an input source to be played back (p.27).

3 (mute)

Mute the audio output (p.27). Touch again to unmute.

4 / (volume +/-)

Adjust the volume (p.27).

5 (power)/CONNECT

Turn on or off the unit.
In addition, use to connect the unit to a network using the MusicCast CONTROLLER app (p.23).

NOTE

The unit may automatically turn off when the auto power standby function is enabled. For details, see the following:

- “Setting the auto power standby function” (p.46)

6 Speakers

7 Remote control sensors

Receive infrared signals from the remote control of the unit (p.9).

NOTE

- ②, ③, ④ and ⑤ are touch sensors. Touch icons with your finger to control functions.
- Do not place any objects on the touch panel as doing so may result in unintended operations.
- When touch panel control is disabled, no operations can be performed using the unit's touch panel. This prevents accidental operation of the unit. For details, see the following:
 - “Enabling/disabling touch panel control (child lock function)” (p.46)

Part names and functions of the rear panel

The part names and functions of the rear panel are as follows.

The illustrations in this manual include labels next to the jacks on the bottom of the unit for easy identification.

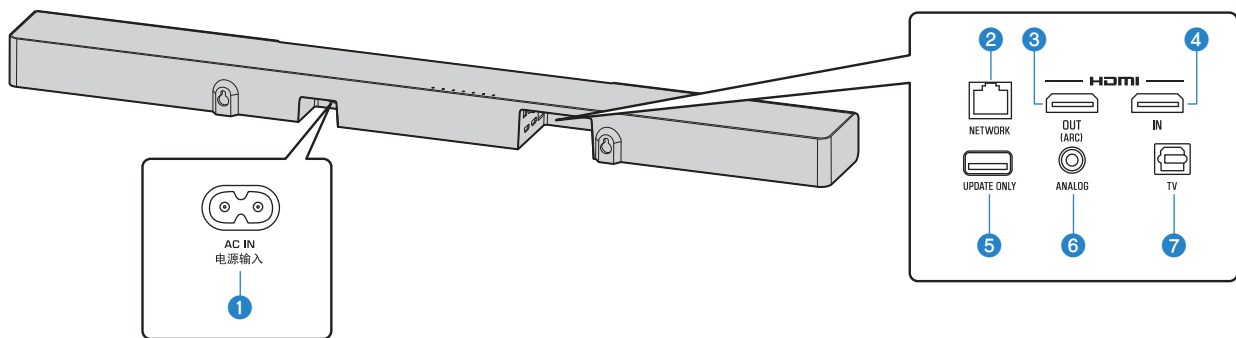

1 AC IN jack

Connect the power cord of the center unit (p.21).

2 NETWORK jack

For connecting to a network with a network cable (p.22).

3 HDMI OUT (ARC) jack

For connecting to an HDMI-compatible TV and outputting video/audio signals (p.18). When a TV that supports Audio Return Channel (ARC) is used, TV audio signal can also be input through this jack.

4 HDMI IN jack

For connecting to an HDMI-compatible playback device, such as a BD/DVD player, a satellite and cable TV tuner, and a game console, and inputting video/audio signals (p.20).

5 UPDATE ONLY jack

Use to update this unit's firmware. The jack is located inside the cover.

Refer to the instructions supplied with the firmware for details.

6 ANALOG input jack

For connecting to an external device with a 3.5 mm stereo mini plug cable and inputting audio signals (p.20).

7 TV input jack

For connecting to a TV with an optical digital audio cable and inputting audio signals (p.19).

Part names and functions of the subwoofer

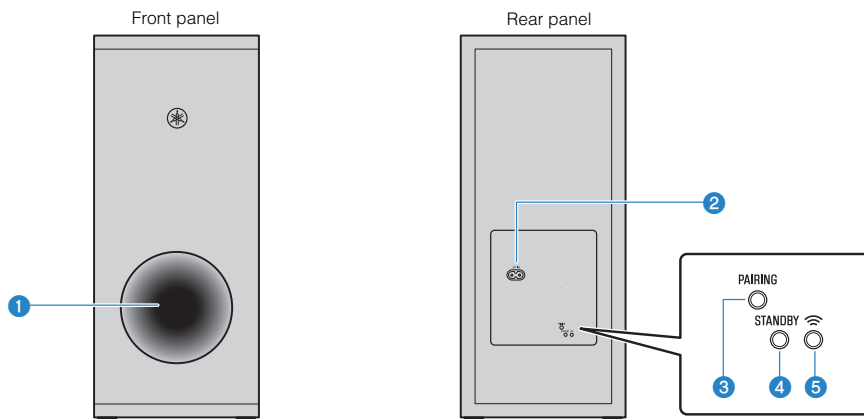

1 Bass reflex port

2 AC IN jack

Connect the power cord of the subwoofer (p.21).

3 PAIRING button

Use to pair the center unit with the subwoofer manually (p.52).

4 STANDBY indicator

Shows subwoofer's status (p.15).

5  indicator

Glow when the center unit and subwoofer are connected wirelessly.

Part names and functions of the remote control

The part names and functions of the supplied remote control are as follows.

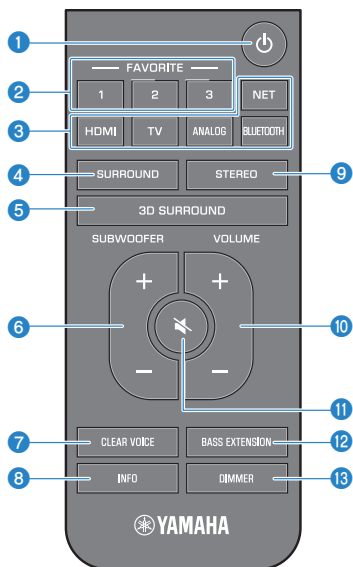

1 (power) button

Turn on/off the unit.

Center unit

Turned on



The indicator for the last input source selected glows.

Turned off/network standby (p.49)



Subwoofer

Turned on



Turned off/network standby (p.49)



2 Favorites (1-3) buttons

Register input sources via a network (Internet radio stations, music files stored on a media server) as favorites with the FAVORITE button (p.36).

3 Input buttons

Select an input source to be played back.

- HDMI : Sound from a device connected to the HDMI IN jack (p.20)
- TV : TV audio (p.18)
- ANALOG : Sound from a device connected to the ANALOG input jack (p.20)
- BLUETOOTH : Sound from a Bluetooth device (p.32)
- NET : Audio acquired via a network (p.27)

4 SURROUND button

Switch to surround playback (p.30).

5 3D SURROUND button

Switch to 3D surround playback (p.30).

6 SUBWOOFER (+/-) button

Adjust the volume of the subwoofer (p.27).

7 CLEAR VOICE button

Enable/disable the clear voice function (p.31).

8 INFO button

Confirm the type of audio signal being played, as well as settings for functions such as the bass extension function (p.35).

9 STEREO button

Switch to stereo (2-channel) playback (p.30).

⑩ **VOLUME (+/-) button**

Adjust the volume of the unit (p.27).

⑪ **🔇 (mute) button**

Mute the audio output (p.27). Press the key again to unmute.

⑫ **BASS EXTENSION button**

Enable/disable the bass extension function (p.31).

⑬ **DIMMER button**

Change the brightness of the indicators (p.44).

PREPARATION

1 Installation

Installing the center unit on a TV stand, etc.

Position the center unit with the touch panel facing up on a TV stand, etc.

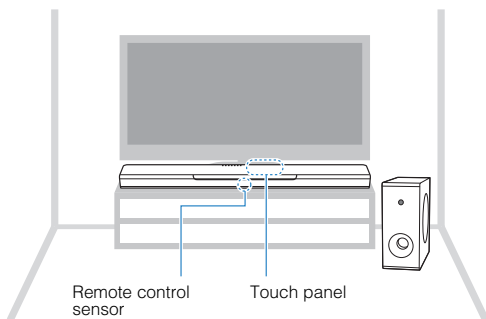

NOTICE

- Do not stack the center unit and a BD player or other device directly on each other. Doing so may cause a malfunction due to vibrations.
- Avoid touching, and never place any weight or pressure on, the subwoofer's speaker (portion covered with fabric). Doing so may damage the speakers.
- Do not install the subwoofer where the speaker (portion covered with fabric) is too close to a wall, or cover the subwoofer's bass reflex port. Doing so may reduce sound volume.
- The subwoofer can only be used in its upright position. Do not position the subwoofer on its side.
- The unit contains non-magnetic shielding speakers. Do not place magnetically sensitive items (hard disk drive, etc.) near the unit.
- The center unit and subwoofer communicate wirelessly. Do not place objects that block or interfere with wireless signals, such as metallic furniture or devices, between the center unit and the subwoofer as wireless communication may be adversely affected.

NOTE

The center unit can also be mounted on a wall. Some knowledge of building construction is required for safe installation. Please have a qualified contractor or dealer install the center unit on a wall. For details, see the following:

- "Information for qualified contractors or dealers" (p.72)

2 Connecting a TV

Connecting a TV that supports Audio Return Channel (ARC)

Connect the TV, which supports Audio Return Channel (ARC), to the unit with an HDMI cable (sold separately).

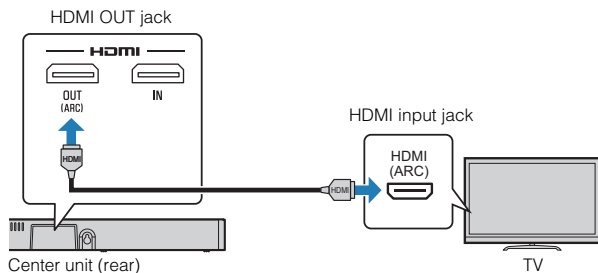

What is Audio Return Channel (ARC)?

In order for the unit to play audio from a TV, the TV must usually be connected to the unit via an audio cable as well as an HDMI cable. If, however, the TV supports Audio Return Channel (ARC), TV audio signals can be input to the unit via the HDMI cable that outputs video signals from the unit to the TV.

NOTE

- Connect an HDMI cable to the audio return channel supported jack (the jack with “ARC” indicated) on TV.
- Enable the HDMI control function of the unit to activate the Audio Return Channel (ARC). For details, see the following:
 - “Configuring the HDMI control function” (p.44)
- Use a 19-pin HDMI cable with the HDMI logo printed on it. A cable with a maximum length of 5 m (16 ft) is recommended to prevent degradation of signal quality.
- Use a premium high-speed HDMI cable for playback of 3D and 4K video content.
- The unit supports HDCP version 2.2, a copy protection technology. For playback of 4K video, connect the unit to the HDMI input jack (one compatible with HDCP 2.2) on an HDCP 2.2-compliant TV.
- The TV input jack cannot be used when a TV that supports the Audio Return Channel is connected to the unit.

Connecting a TV that does not support Audio Return Channel (ARC)

Connect the TV to the unit with an HDMI cable (sold separately) and an optical digital audio cable (supplied).

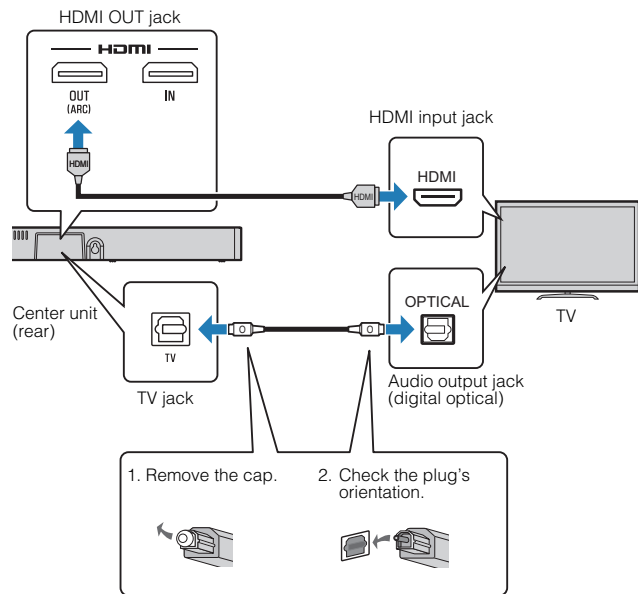

NOTE

- Use a 19-pin HDMI cable with the HDMI logo printed on it. A cable with a maximum length of 5 m (16 ft) is recommended to prevent degradation of signal quality.
- Use a premium high-speed HDMI cable for playback of 3D and 4K video content.

- The unit supports HDCP version 2.2, a copy protection technology. For playback of 4K video, connect the unit to the HDMI input jack (one compatible with HDCP 2.2) on an HDCP 2.2-compliant TV.
- If the TV has no optical jack, connect the audio output jack on the TV to the ANALOG input jacks on the unit. For details, see the following:
 - “Analog connection with a playback device” (p.20)

3 Connecting playback devices

HDMI connection with a playback device

Connect a playback device such as a BD/DVD player to the unit with an HDMI cable (sold separately). Use the HDMI cable to best connect a playback device equipped with the HDMI output jack.

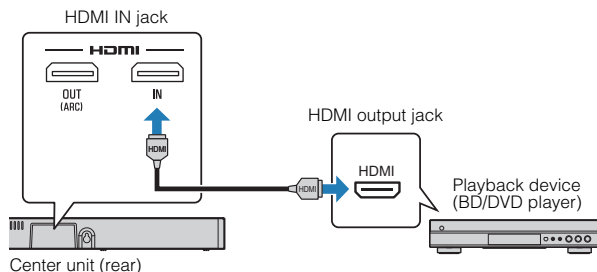

NOTE

- Once the HDMI control function has been activated, video and audio contents from playback devices can be output from the TV even when the unit is turned off (HDMI signal pass-through). For details, see the following:
 - “Configuring the HDMI control function” (p.44)
- Use a 19-pin HDMI cable with the HDMI logo printed on it. A cable with a maximum length of 5 m (16 ft) is recommended to prevent degradation of signal quality.
- Use a premium high-speed HDMI cable for playback of 3D and 4K video content.
- The unit supports HDCP version 2.2, a copy protection technology. For playback of 4K video, connect the unit to the HDMI output jack on a HDCP 2.2-compliant BD/DVD player.

Analog connection with a playback device

Connect a playback device, such as a game console or a TV that does not have an optical digital audio output, to the unit via a 3.5 mm stereo mini plug cable (sold separately).

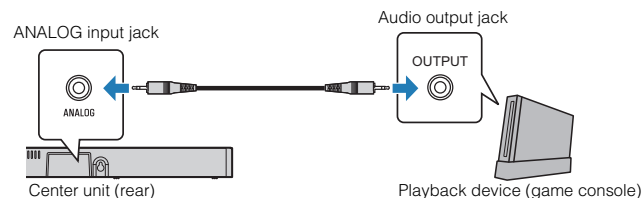

CAUTION

- If volume can be adjusted on the device connected to the unit's ANALOG input jack, set that device's volume to the same level as that of other devices connected to the unit's HDMI IN jack to prevent volume from being louder than expected.

NOTE

When connecting the video device, connect the video device's video output to the TV's video input directly.

4 Connecting the power cord

Connecting the power cord

Once all connections have been made, connect the supplied power cords to the AC IN jacks on the center unit and subwoofer respectively, and plug the power cables into AC wall outlets.

Center unit

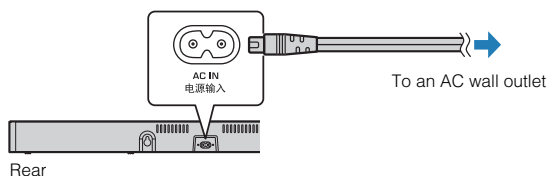

Subwoofer

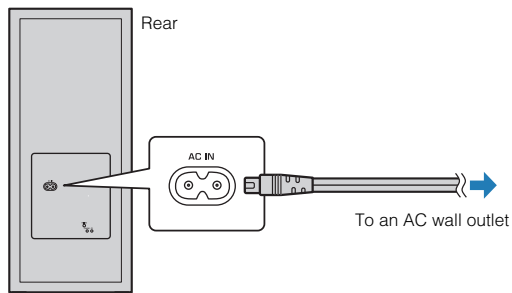

5 Connecting to a network

Network functions and the MusicCast CONTROLLER app

A network connection allows you to listen to Internet radio stations or music streaming services, and to use AirPlay to play music files, or to play music files stored on your computer (media server) via this unit.

Most playback requires the MusicCast CONTROLLER app for mobile devices. Install and use the MusicCast CONTROLLER app on your mobile device to play music files.

Proceed from network connection to playback in the following sequence.

- 1 Choose a wired network connection (p.22) or a wireless network connection (p.23).
- 2 Use the MusicCast CONTROLLER app to connect the unit to a network, and register the unit as a MusicCast-enabled device (p.23).
- 3 Use the MusicCast CONTROLLER app to play music over a network* (p.39, p.40, p.42, p.43).

* AirPlay can be used to play music files without using the MusicCast CONTROLLER app.

NOTE

- To use network function, the unit, computer and mobile device must be connected to the same router.
- When using a multiple SSID router, access to the unit might be restricted depending on the SSID to connect. Connect the unit and mobile device to the same SSID.

- Some security software installed on your computer, or network device settings (such as a firewall), may block the unit's access to your computer or Internet radio stations. Should this occur, change security software and/or network device settings.
- A network connection cannot be established if the MAC address filter on your router is enabled. Check your router's settings.
- To configure your router's subnet mask manually, apply the same subnet used by this unit to all devices.
- Use of a broadband connection is recommended when using Internet services.
- The unit cannot be connected to a network that requires manual setup. Connect the unit to a DHCP enabled router.

Wired network connections

To use a wired network connection, connect the unit to a router via an STP network cable (category 5 or higher straight cable; sold separately).

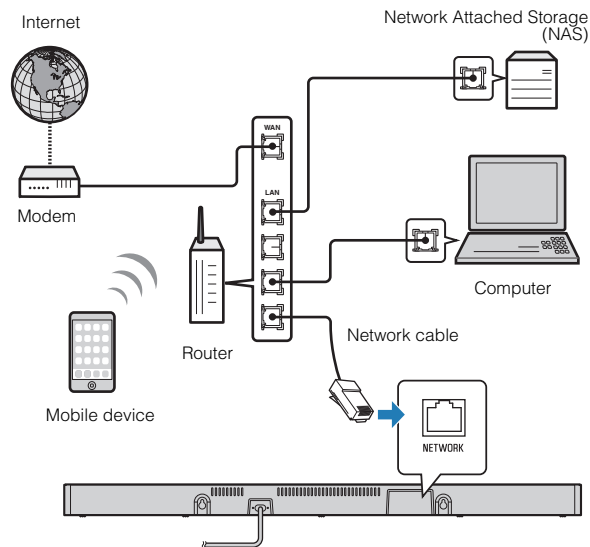

NOTE

If network connections or settings are changed, use the MusicCast CONTROLLER app to connect the unit to a network and register the unit as a MusicCast-enabled device again (p.23).

Wireless network connections

Connect the unit to a wireless router (access point) to use a network.

See the following for instructions on connecting to a wireless router (access point).

- “Connecting with the MusicCast CONTROLLER app (registering the unit as a MusicCast-enabled device)” (p.23)
- “Connecting to a network using the WAC function” (p.53)

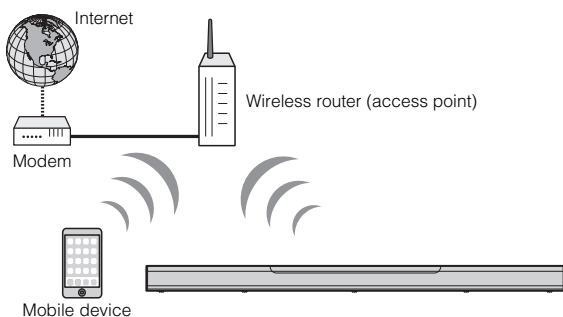

The  indicator on the unit glows when the unit is connected to a wireless network.

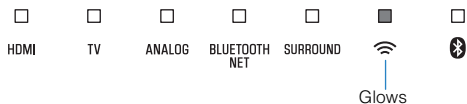

NOTE

If the unit and the wireless router (access point) are too far apart, the unit may not connect to a wireless router (access point). In such case, place them close to each other.

Connecting with the MusicCast CONTROLLER app (registering the unit as a MusicCast-enabled device)

Install the MusicCast CONTROLLER app on your mobile device to connect the unit to a network and register it as a MusicCast-enabled device.

NOTE

- Confirm that your mobile device is connected to your home router before beginning.
- This section uses MusicCast CONTROLLER app screens displayed in English on an iPhone as examples.
- MusicCast CONTROLLER app screens and menu labels are subject to change without prior notice.

1 Install the MusicCast CONTROLLER app on your mobile device, and open the app.

Search for “MusicCast CONTROLLER” on the App Store or Google Play.

2 Tap “Setup”.



4 Touch and hold /CONNECT until the indicator on the unit starts flashing.

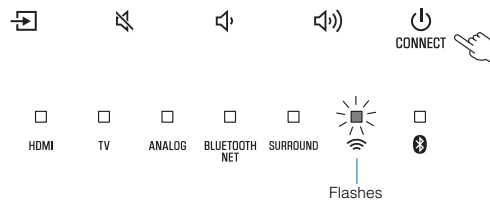

3 Turn on the unit, and then tap “Next”.

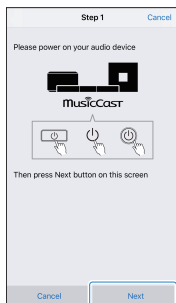

5 Follow the on-screen instructions to configure network settings.

NOTE

When a screen like that below is displayed, follow the on-screen instructions to configure network settings.

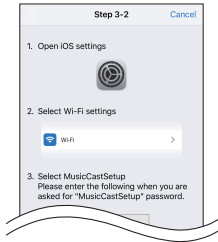

1. Use the Home button on your mobile device to return to the Home screen.
2. Select "Wi-Fi" from "Settings".
3. Select "MusicCastSetup" from "CHOOSE A NETWORK...". If the on-screen instructions prompt you to enter the MusicCastSetup password, enter the password displayed on the screen.
4. Use the Home button to return to the MusicCast CONTROLLER app.

Entering the router's password

When a screen like that at left below is displayed, select the network to which the unit will be connected and enter the router's password (encryption key). The router's password (encryption key) is often noted on the router itself. Refer to documentation supplied with the router for details.

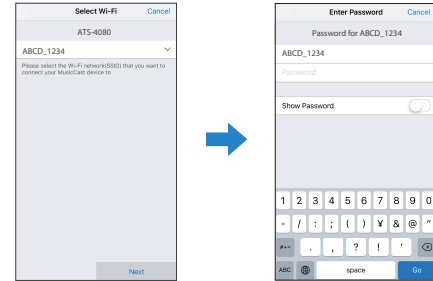

6 To register the unit as a MusicCast-enabled device, configure the following items.

- Location name (“home”, “John’s house”, etc.)
- Name and photo of the room where the unit is installed

The location name, and the name and photo of the room where the unit is installed can be changed later.

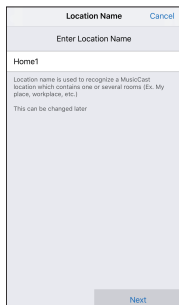

The screenshot shows a mobile app interface for configuring a location name. At the top, there is a title bar with 'Location Name' and a 'Cancel' button. Below the title bar is a text input field labeled 'Enter Location Name' containing the text 'Home1'. Underneath the input field, there is a small informational text block: 'Location name is used to recognize a MusicCast location which contains one or several rooms (Ex. My place, workplace, etc.) This can be changed later.' At the bottom right of the screen, there is a 'Next' button.

Network connection with the MusicCast CONTROLLER app is now complete, and the unit has been registered as a MusicCast-enabled device.

NOTE

If a different MusicCast-enabled device is already registered with the MusicCast CONTROLLER app, tap  (Settings) in the room selection screen, and then select “Add New Device” to add the unit to the app.

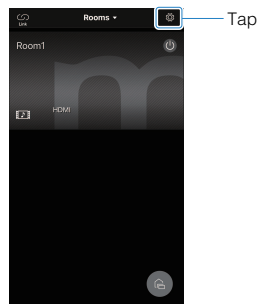

PLAYBACK

Basic operations

Basic procedure for playback

Basic procedure for playing back music is as follows.

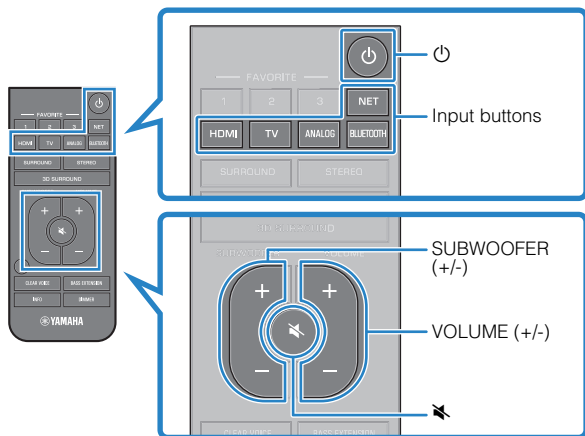

1 Press to turn on the unit.

The center unit and subwoofer are automatically connected via wireless connection. Once the connection has been successfully established, the  indicator on the subwoofer's rear panel glows, and the unit is ready for playback.

2 Turn on the external devices (such as a TV or BD/DVD player, game console) connected to the unit.

3 Use the input buttons to select an input source to be played back.

HDMI: Sound from a device connected to the HDMI IN jack

TV: TV audio

ANALOG: Sound from a device connected to the ANALOG input jack

BLUETOOTH: Sound from a Bluetooth device

NET: Audio acquired via a network

The indicator for the selected input source glows.

Example

When TV is selected



4 Start playback on the external device selected in step 3.

5 Press VOLUME (+/-) to adjust the volume.

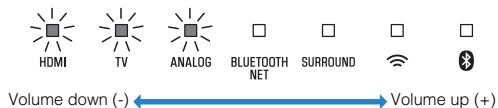

When audio is output from both TV speaker and the unit, mute the TV sound.

6 Adjust sound settings to suit individual preferences.

NOTE

- If the Wi-Fi indicator on the subwoofer does not glow properly the first time the unit is turned on, pair the center unit and subwoofer manually. For details, see the following:
 - “Pairing the center unit and subwoofer manually” (p.52)
- For details on adjusting sound settings, see the following:
 - “Playback with 3D surround sound” (p.30)
 - “Playback with surround sound” (p.30)
 - “Playback with 2-channel stereo sound” (p.30)
 - “Playback of human voices clearly (clear voice)” (p.31)
 - “Enjoying enhanced bass sound (bass extension)” (p.31)
- For details on playing music files stored on a Bluetooth device, see the following:
 - “Listening to music stored on a Bluetooth® device” (p.32)
- For details on playing audio via a network, see the following:
 - “Play music with AirPlay” (p.37)
 - “Play music stored on a media server (computer or NAS)” (p.39)
 - “Listening to Internet radio” (p.40)
 - “Listening to streaming services” (p.42)

- To mute the sound, press . Press  again to unmute.



Flash (on mute)

- When sound input to the HDMI IN jack is output from the TV, the volume level does not change even if you press VOLUME (+/-) or .
- To adjust the subwoofer volume, press SUBWOOFER (+/-). The subwoofer volume can be adjusted separately from the whole volume.



Volume down (-)  Volume up (+)

- When playing audio/video from a device connected to the TV, select TV as the unit's input source, and select the playback device with the input selector on the TV.

Enjoying your favorite sound

Playback with 3D surround sound

Press 3D SURROUND to switch to 3D surround playback according to the input source or your individual preference.

When 3D surround playback is selected, DTS Virtual:X makes it possible to hear sound not only from horizontal directions, but also from varying heights.

The SURROUND indicator glows blue.



NOTE

The TV Program, Movie, Music, Sports, or Game surround mode can be selected using the dedicated MusicCast CONTROLLER app installed on a mobile device when the unit is connected to a network and registered as a MusicCast-enabled device with the app. For details, see the following:

- "Connecting with the MusicCast CONTROLLER app (registering the unit as a MusicCast-enabled device)" (p.23)

Playback with surround sound

Press SURROUND to switch to surround playback according to the input source or your individual preference.

The SURROUND indicator glows white.

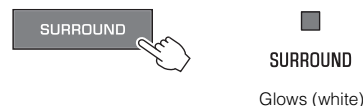

NOTE

The TV Program, Movie, Music, Sports, or Game surround mode can be selected using the dedicated MusicCast CONTROLLER app installed on a mobile device when the unit is connected to a network and registered as a MusicCast-enabled device with the app. For details, see the following:

- "Connecting with the MusicCast CONTROLLER app (registering the unit as a MusicCast-enabled device)" (p.23)

Playback with 2-channel stereo sound

Press STEREO to switch to 2-channel stereo playback. You can enjoy playback sources with your favorite sound mode.

When stereo playback is enabled, the SURROUND indicator goes out.



Playback of human voices clearly (clear voice)

Press CLEAR VOICE to turn on the clear voice function. Human voices such as lines in movies and TV shows, or news and sport commentary, are played clearly.

Press the button again to disable the function.

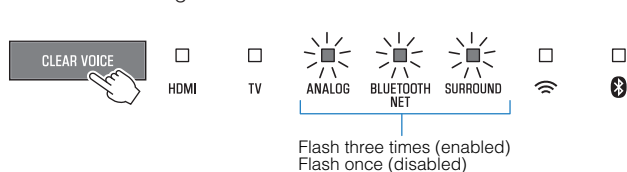

NOTE

Press INFO to confirm whether the clear voice function is enabled or disabled. For details, see the following:

- “Showing audio information and function settings” (p.35)

Enjoying enhanced bass sound (bass extension)

Press BASS EXTENSION to turn on the bass extension function. You can enjoy enhanced bass sound and more powerful sound.

Press the button again to disable the function.

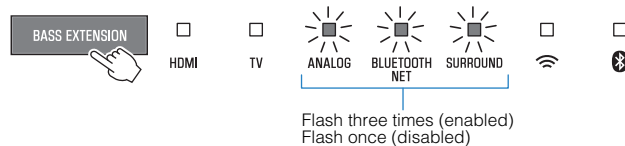

NOTE

Press INFO to confirm whether the bass extension function is enabled or disabled. For details, see the following:

- “Showing audio information and function settings” (p.35)

Use of a Bluetooth® device

Listening to music stored on a Bluetooth® device

Music files stored on a Bluetooth device, such as a smartphone, smart speaker, or digital music player, can be played on the unit over a wireless connection.

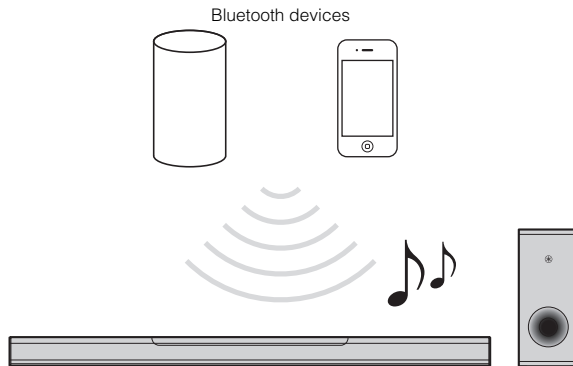

NOTE

The network standby function is enabled by default. When a Bluetooth device is connected to this unit while the unit is off, the unit will be turned on and will be immediately ready to play sound from the Bluetooth device. For details, see the following:

- “Enabling/disabling the network standby function” (p.49)

- 1 Press **BLUETOOTH** to select “Bluetooth” as the input source.

The BLUETOOTH/NET indicator on the unit glows.



NOTE

If Bluetooth devices have been connected before, the unit will connect to the last connected device when BLUETOOTH is pressed.

- 2 On the Bluetooth device, enable the Bluetooth function.

The Bluetooth device list appears on the Bluetooth device.

3 Select this unit in the list.

When the unit has been registered as a MusicCast-enabled device, the room name specified for the unit is displayed in the list. Otherwise, "ATS-4080 XXXXX Bluetooth" is displayed. If a passkey (PIN) is required, enter the number "0000".

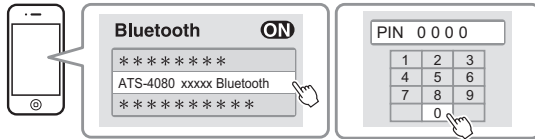

When the connection between the Bluetooth device and the unit is established, a completion message is displayed on the Bluetooth device, and the  indicator on the unit glows blue.



4 Play a song on the Bluetooth device.

The unit will begin playing audio from the Bluetooth device.

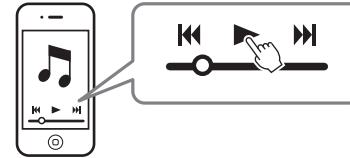

NOTE

- To terminate the Bluetooth connection, perform one of the following operations.
 - Turn off the Bluetooth function on the Bluetooth device.
 - Hold down BLUETOOTH for more than 3 seconds.
 - Select an input source other than Bluetooth on the unit.
 - Turn off the unit.
- If the Bluetooth connection is terminated when the unit's input is BLUETOOTH, the  indicator turns off and the unit enters the connection wait status.
- Adjust the volume level of the Bluetooth device as required.
- Perform Bluetooth connection with the Bluetooth device and unit within 10 m (33 ft) of each other.
- See documentation supplied with your Bluetooth device for more information.

Useful features for playback

Using a TV's remote control to operate the unit (HDMI control)

The HDMI control function coordinates TV and unit operation so that the unit can be operated using the TV's remote control.

When the unit is connected to a TV via HDMI cable, the TV's remote control can be used to perform the following operations.

Operations that can be controlled via the TV's remote control

TV's remote control (example)

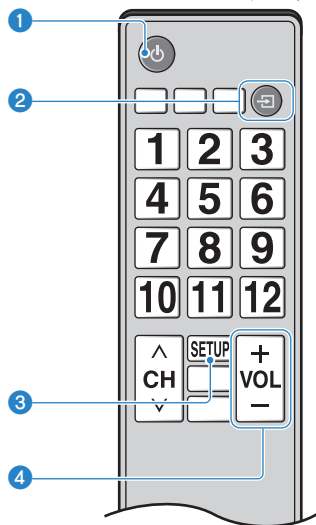

1 Turn on/off

Both the TV and the unit turn on/off at the same time.

2 Switch input sources

The unit's input source switches accordingly when the TV's input source is switched.

For example, when a TV program is selected on the TV, the unit's audio input source is switched to the HDMI OUT (ARC) jack using the ARC function or TV input jack.

And also, when a BD/DVD player is connected to the HDMI IN jack on the unit, the unit's input source switches to HDMI when the BD/DVD player is selected with the TV's remote control.

3 Switch the audio output device

The audio output device can be switched to the TV or this unit.

4 Adjust volume

The unit's volume can be adjusted when the TV's audio output is set to the unit.

NOTE

- If you are unable to operate the unit with your TV's remote control, configure the HDMI control function of your TV and the unit. For details, see the following:
 - “Configuring the HDMI control function” (p.44)
- The input source can be switched while the unit is off (HDMI signal pass-through).
- The volume displays on the TV and unit may not be the same.

Showing audio information and function settings

The type of audio signal being played, as well as settings for functions such as the bass extension function can be confirmed by the status of indicators.

1 Press INFO on the remote control.

The indicators on the unit will show the following audio information for three seconds immediately after INFO is pressed.

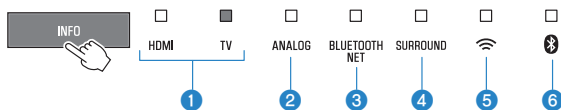

- 1 Show the type of audio signal.**
HDMI glows (white): Dolby Digital
HDMI glows (red): DTS
TV glows (white): AAC
HDMI and TV off: PCM/analog input/no input
- 2 Show whether Dolby Pro Logic II is enabled or disabled. Dolby Pro Logic II is enabled automatically when 2-channel stereo signals are played in surround sound.**
Glow: Enabled
Off: Disabled
- 3 Show the bass extension function setting.**
Glow: Enabled
Off: Disabled
- 4 Show the clear voice function setting.**
Glow: Enabled
Off: Disabled
- 5 Show the network standby function setting.**
Glow: Enabled
Off: Disabled
- 6 Show the Bluetooth function setting.**
Glow (blue): Enabled
Off: Disabled

Registering favorites with the unit

Use the FAVORITE button to register input sources played over a network (Internet radio stations, music files stored on a media server, etc.) as favorites.

1 Play the input source to be registered.

“Play music stored on a media server (computer or NAS)” (p.39)

“Listening to Internet radio” (p.40)

“Listening to streaming services” (p.42)

2 Press and hold FAVORITE 1, 2, or 3 at least three seconds.

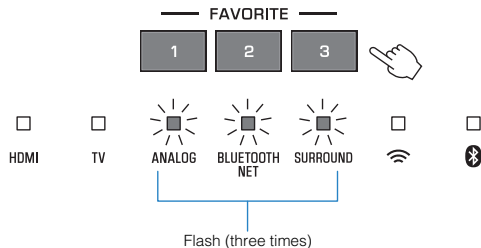

Play favorite input sources

1 Press FAVORITE 1, 2, or 3 to which the desired Internet radio station has been assigned.

NOTE

Favorites assigned to FAVORITE 1, 2, or 3 using the remote control will also be assigned to MusicCast CONTROLLER app “Favorites” 1, 2, and 3. If favorite 1, 2, or 3 is changed with either the unit or the MusicCast CONTROLLER app, the corresponding favorite will also be automatically changed with the other.

Play music with AirPlay

Playing iTunes/iOS device music with AirPlay

Music files in iTunes, or stored on an iOS device such as an iPhone, can be played on the unit using the AirPlay function via a network.

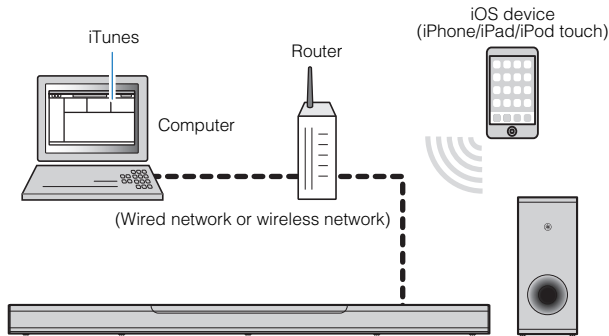

- 1 Start iTunes on the computer or display the playback screen on the iOS device.**

- 2 Click or tap the AirPlay icon in iTunes or on the iOS device, and select the unit (network name of the unit) as the audio output device.**

On an iOS device, the AirPlay icon is displayed on the playback screen of the Music app, or in the Control Center.



- 3 Select a song and start playback in iTunes or on the iOS device.**

The unit automatically selects “AirPlay” as the input source and starts playback. The unit’s volume can also be adjusted using iTunes or iOS device.



CAUTION

- When the volume control in iTunes or on the iOS device is used, the volume may be unexpectedly loud. This could result in damage to the unit or speakers. If the volume suddenly increases during playback, stop playback in iTunes or on the iOS device immediately.

NOTE

The network standby function is enabled by default. When a music file in iTunes, or stored on an iOS device, is played while the unit is off, the unit turns on and is immediately ready to play sound from iTunes or the iOS device. For details, see the following:

- “Enabling/disabling the network standby function” (p.49)

Play music stored on a media server (computer or NAS)

Playing music stored on a media server (computer or NAS)

Music files stored on a media server can be played on the unit.

NOTE

- Media sharing with this unit must first be enabled on the media server. See documentation supplied with the computer (or NAS), or the app for instructions on enabling media sharing.
- Use the MusicCast CONTROLLER app installed on a mobile device to play music. Be sure to register the unit with the MusicCast network in advance. For details, see the following:
 - “Connecting with the MusicCast CONTROLLER app (registering the unit as a MusicCast-enabled device)” (p.23)
- The unit and media server must be connected to the same wireless router.
- The audio may be interrupted while using the wireless network connection. In this case, use the wired network connection.
- For details on playable file formats, see the following:
 - “Supported file formats” (p.71)

1 Use the MusicCast CONTROLLER app to select the unit’s room (Room1, etc.).

2 Tap  (Server).

3 Follow the on-screen instructions to select a song.

NOTE

When a music file is registered with No. 1, 2, or 3 in “Favorites” with the MusicCast CONTROLLER app, the registered music file can be played with FAVORITE 1, 2, or 3 on the remote control. For details, see the following:

- “Registering favorites with the unit” (p.36)

Listening to Internet radio

Selecting an Internet radio station

Select an Internet radio station and start playback.

NOTE

- Use the MusicCast CONTROLLER app installed on a mobile device to select an Internet station. Be sure to register the unit with the MusicCast network in advance. For details, see the following:
 - “Connecting with the MusicCast CONTROLLER app (registering the unit as a MusicCast-enabled device)” (p.23)
- Some Internet radio stations may not be available.
- This function uses airable.Radio’s extensive catalog. “airable” is a service of Tune In GmbH.
- This service may be discontinued without notice.

1 Use the MusicCast CONTROLLER app to select the unit’s room (Room1, etc.).

2 Tap  (Net Radio).

3 Select a station from the list.

NOTE

When an Internet radio station is registered with No. 1, 2, or 3 in “Favorites” with the MusicCast CONTROLLER app, the registered Internet radio station can be played with NET RADIO 1, 2, or 3 on the remote control. For details, see the following:

- “Registering favorites with the unit” (p.36)

Bookmark an Internet station

Bookmark an Internet station being played.

NOTE

Use the MusicCast CONTROLLER app installed on a mobile device to select an Internet station. Be sure to register the unit with the MusicCast network in advance. For details, see the following:

- “Connecting with the MusicCast CONTROLLER app (registering the unit as a MusicCast-enabled device)” (p.23)

1 Select an Internet radio station.

2 Tap  in the playback screen, and then tap “Add Bookmark”.

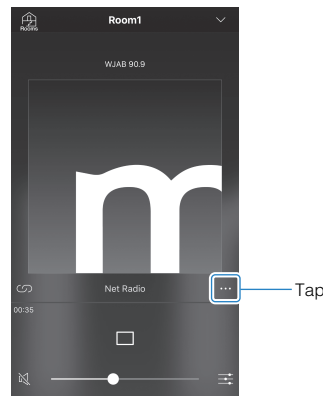

Tuning into registered Internet radio stations

- 1 Tap “Radio”, and then tap “Favorites” to select the desired Internet radio station.

Listening to streaming services

Listening to a streaming service

A streaming service can be heard using the MusicCast CONTROLLER app installed on a mobile device. On the MusicCast CONTROLLER screen, select the room name that was specified for the unit, and then select the streaming service to be tuned into by its station name. For details, see the MusicCast CONTROLLER app.

NOTE

- Service is limited to certain areas.
- Services supported with the unit may not be available depending upon some regions where the unit is purchased.
- Service may change or be discontinued without notice.
- Use the MusicCast CONTROLLER app installed on a mobile device to listen to streaming services. Be sure to register the unit with the MusicCast network in advance. For details, see the following:
 - “Connecting with the MusicCast CONTROLLER app (registering the unit as a MusicCast-enabled device)” (p.23)
- For details on music streaming services, see the supplements for streaming services. Access the Yamaha Downloads site to download the supplement. <https://download.yamaha.com/>

Play music stored on mobile devices

Playing songs stored on your mobile device

Play songs stored on your mobile device over a network.
Use the MusicCast CONTROLLER app installed on your mobile device to play songs.

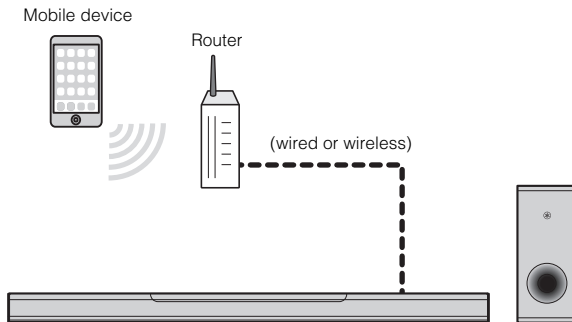

NOTE

Be sure to register the unit with the MusicCast network in advance to use this function. For details, see the following:

- “Connecting with the MusicCast CONTROLLER app (registering the unit as a MusicCast-enabled device)” (p.23)

1 Use the MusicCast CONTROLLER app to select the unit’s room (Room1, etc.).

2 Tap  (the name of the mobile device).

3 Select a song from “Playlists”, “Artists”, etc.

CONFIGURATIONS

Configuring various functions

Changing the brightness of the indicators (DIMMER)

Change the brightness of the indicators on the center unit.

Each time DIMMER is pressed, the brightness of the indicators changes as follows.

Dim (default setting) → Off → Bright → Dim → ...



Indicators glow brightly just after operation and change to the specified brightness after a few seconds.

Configuring the HDMI control function

Enable or disable the unit's HDMI control function (link function). This function coordinates TV and unit operation so that the unit can be operated using the TV's remote control.

This function is enabled by default.

1 Turn off the unit.

2 Press and hold HDMI at least three seconds.



The HDMI control function is enabled or disabled, and the unit turns on. The indicator shows HDMI control function status for several seconds, and then all indicators glow.

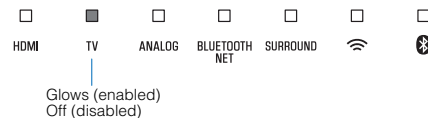

NOTE

- Enable the HDMI control function when connecting a TV that supports Audio Return Channel (ARC), or when using HDMI signal pass-through. For details, see the following:
 - “Connecting a TV that supports Audio Return Channel (ARC)” (p.18)
 - “Using a TV’s remote control to operate the unit (HDMI control)” (p.34)
- If the unit cannot be operated with the TV’s remote control, confirm that the HDMI control function of this unit is enabled and the HDMI control function is enabled on the TV. For details, see the following:
 - “The unit cannot be operated using the TV’s remote control” (p.59)
- The unit’s power consumption will be reduced if the HDMI control function is disabled.

Configuring HDMI audio output

Select the device from which audio input via the unit's HDMI IN jack will be played when the HDMI control function is disabled. HDMI audio is output from this unit by default.

Settings

The unit (default)	Play HDMI audio input signal from the unit.
TV Play	HDMI audio input signal from the TV.

1 Turn off the unit.

2 Press and hold SURROUND at least three seconds.



HDMI audio output switches between the unit and the TV, and the unit turns on. The indicator shows HDMI audio output status for several seconds, and then all indicators glow.



NOTE

- When playing back HDMI audio input signal from the TV, the unit cannot be used to adjust volume. Use TV controls to adjust volume.
- For details on the HDMI control function, see the following:
 - “Configuring the HDMI control function” (p.44)
- To configure HDMI audio output with the HDMI control function enabled, select the audio output device configured for the TV connected to the unit.
- HDMI video signals input to the HDMI IN jack of this unit are always output from the HDMI OUT (ARC) jack of the unit.

Setting the auto power standby function

Enabling the auto power standby function prevents the unit from remaining on when not in use. When the auto power standby function is enabled, the unit automatically turns off in any of the following situations.

- No operations for 8 hours
- No audio input and no operations for 20 minutes when Bluetooth or HDMI is selected as the input source.

1 Turn off the unit.

2 Touch and hold and then touch and hold /CONNECT on the unit for at least three seconds.



The auto power standby function is enabled or disabled, and the unit is turned on. The indicator shows auto power standby function status for several seconds, and then all indicators glow.

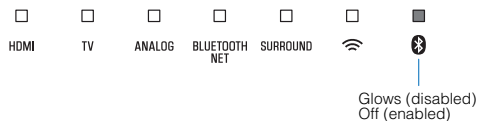

NOTE

The default setting for the auto power standby function varies by country or region.

- U.K., Europe, and Korea models: enabled
- Other models: disabled

Enabling/disabling touch panel control (child lock function)

Disable touch panel control to prevent children from accidentally operating the unit. When touch panel control is disabled, operations can be performed only via the remote control or dedicated free "MusicCast CONTROLLER" app.

This function is enabled by default.

1 Turn off the unit.

2 Press and hold INFO at least three seconds.



The touch panel control is enabled or disabled, and the unit is turned on. The indicator shows touch panel control status for several seconds, and then all indicators glow.

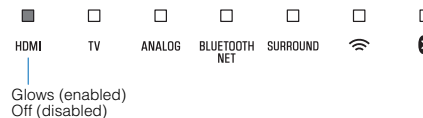

Using surround speakers (MusicCast Surround function)

Devices that support the MusicCast Surround function and serve as “Pairing Devices”, such as the MusicCast 20, can be used as surround speakers with this unit.

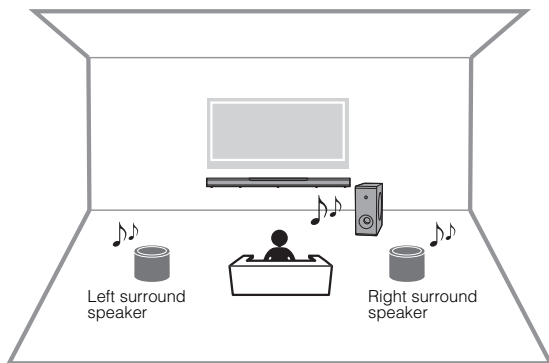

- 1 Use the MusicCast CONTROLLER app to register the unit and devices that support the MusicCast Surround function (Pairing Devices) with the same location.**
- 2 Set up all MusicCast Surround (wireless extension) compatible devices in the same room as the unit.**

3 Open the MusicCast CONTROLLER app.

4 Tap  (Setup).

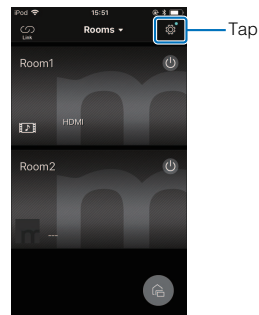

5 Tap “MusicCast Surround/Stereo”.

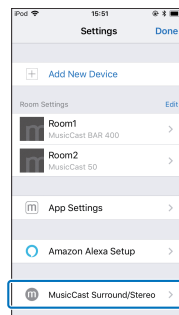

6 Select the room in which the unit is set up.



7 Follow the instructions on the app screen and complete setup.

Configure settings such as what devices will be connected as the unit's surround speakers, and how many there are.

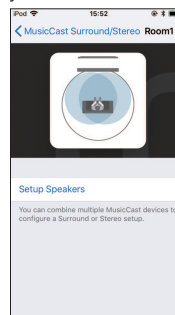

NOTE

- This function will be made available through a future firmware update. For details, refer to the website for this product.
- Functions and installation may vary depending upon the devices that support the MusicCast Surround function (Pairing Devices) used. For details, see documentation supplied with the device.
- After setup, you can adjust the levels of the surround speakers and check the balance using test tones. For details, see the following:
 - "Adjusting the levels of the speakers" (p.54)

Enabling/disabling the network standby function

Enabling the network standby function allows the unit to be turned on or off using a mobile or Bluetooth device as follows. This function is enabled by default.

- When the unit is turned off, it will turn on with the following playback operations.
 - Music files are played using the AirPlay function.
 - Music files stored on a network attached storage (NAS) unit are played
- The unit can also be turned on and off using the MusicCast CONTROLLER app installed on your mobile device.
- When a Bluetooth device is connected to this unit while it is off, this unit turns on and the input source switched to BLUETOOTH.

1 Turn off the unit.

2 Touch and hold and then touch and hold /CONNECT on the unit for at least three seconds.



The network standby function is enabled or disabled, and the unit turns on. The indicator shows network standby function status for several seconds, and then all indicators glow.

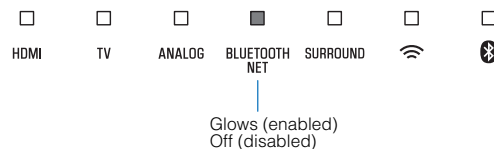

NOTE

- The unit consumes more power when it is off with the network standby function enabled than it does when it is off with this function disabled.
- Press INFO to confirm whether the network standby function is enabled or disabled. For details, see the following:
 - “Showing audio information and function settings” (p.35)

Enabling/disabling a wireless (Wi-Fi) connection

Enable or disable a wireless (Wi-Fi) connection.
This function is enabled by default.

- 1 Turn off the unit.
- 2 Press and hold NET at least three seconds.



The wireless (Wi-Fi) connection is enabled or disabled, and the unit turns on. The indicator shows wireless (Wi-Fi) connection status for several seconds, and then all indicators glow.

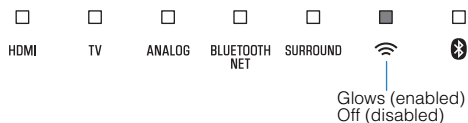

Enabling/disabling the Bluetooth function

Enable or disable the Bluetooth function.
This function is enabled by default.

- 1 Turn off the unit.
- 2 Press and hold BLUETOOTH at least three seconds.



The Bluetooth function is enabled, and the unit turns on. The indicator shows Bluetooth function status for several seconds, and then all indicators glow.

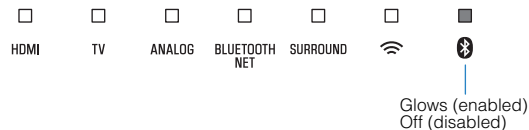

NOTE

Press INFO to confirm whether the Bluetooth function is enabled or disabled. For details, see the following:

- "Showing audio information and function settings" (p.35)

Updating the unit's firmware

New firmware that provides additional features or product improvements will be released as needed. Firmware can be updated using the MusicCast CONTROLLER app installed on a mobile device.

NOTICE

- Do not operate the unit or disconnect the power cord or network cable during firmware update.
- If the Internet connection speed is slow, or the unit is connected to the wireless network, network update may not be possible depending on the condition of the network connection. Should this occur, try again at a later time.
- For details on update, visit the Yamaha website.

When a new firmware is released, the "Update new firmware now?" message is displayed on the MusicCast CONTROLLER app's screen.

1 Tap "Yes".

The firmware update will begin. A progress bar indicating update progress will be displayed by the app while firmware is updated.

NOTE

If "Later" is selected, tap ⚙️ (Settings) in the app's room selection screen, and then select "New firmware is available". Follow the on-screen instructions to update the firmware.

If the update is completed successfully, the "Firmware update completed" message will be displayed on the app's screen, and all indicators on the unit will flash.



2 Touch ⏻/CONNECT on the unit.



The firmware update is complete.

NOTE

If the firmware update fails, the "Failed to update MusicCast device" message will be displayed by the app, and HDMI indicator on the unit will flash red. Press ⏻ to turn unit off and then on again, and try updating the firmware again. If the update fails again, check the network connection.

Pairing the center unit and subwoofer manually

The center unit and subwoofer are automatically connected via wireless connection the first time the unit is turned on. If the center unit and subwoofer are not properly connected due to a temporary communications failure, pair the center unit and subwoofer manually.

NOTE

Pairing is the process of establishing a wireless connection between the center unit and subwoofer.

- 1 Turn off the unit.
- 2 Press and hold SUBWOOFER (-) at least three seconds.

The TV indicator on the center unit flashes.

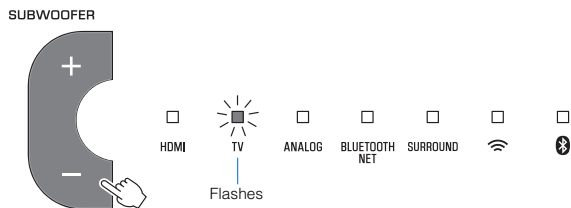

- 3 Within 30 seconds, press and hold the PAIRING button on the rear panel of the subwoofer at least three seconds.

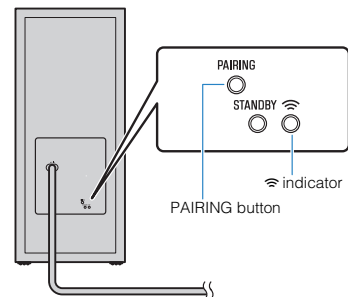

Once the center unit and subwoofer have been paired and a wireless connection established, the  indicator will glow, and the center unit and subwoofer turn on.



If the  indicator on the subwoofer does not glow after following the procedure described here, see “No sound is coming from the subwoofer” (p.60).

Initializing the unit

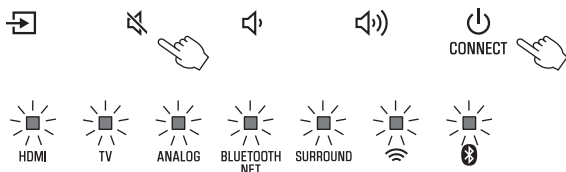

Reset the settings of the unit to the factory presets.

- 1 Turn off the unit.
- 2 Touch and hold  and /CONNECT on the unit until all indicators flash.



Flash (initialized)

Connecting to a network using the WAC function

When the unit is turned on for the first time after purchase, the  indicator on the center unit flashes slowly. While the  indicator is flashing, network settings from your iOS device (an iPhone, etc.) can be applied to the unit to connect the unit to a wireless network (WAC function).

NOTE

The  indicator does not flash if the unit's NETWORK jack is connected to a router using a cable (wired connection).

- 1 Display Wi-Fi settings on the iOS device and select the unit from “SETUP A NEW AIRPLAY SPEAKER...”.

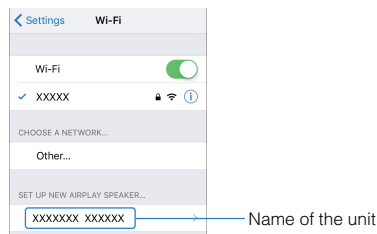

- 2 When the following screen is displayed, select the network (access point) to which the unit will be connected.

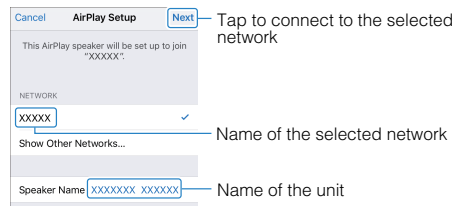

NOTE

If the unit is connected to a network using the MusicCast CONTROLLER app, network settings will be changed to those of the MusicCast CONTROLLER app.

Adjusting the levels of the speakers

Adjust the levels of the surround speakers connected to the main unit using the MusicCast Surround function.

This setting is available only when the MusicCast Surround function is in use.

1 Open the MusicCast CONTROLLER app.

2 Tap  (Setup) on the room selection screen.

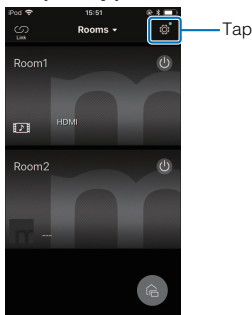

3 Tap “MusicCast Surround/Stereo”.

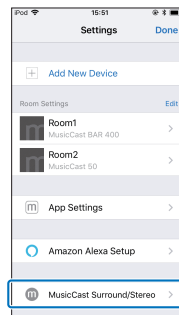

4 Select the room in which the unit is set up.

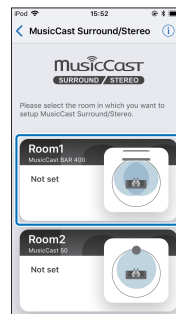

5 Select “Speaker Setup”.

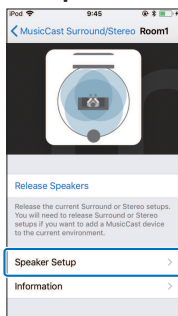

6 Set up according to the instructions on the screen.

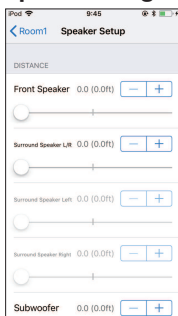

You can set up the following.

- DISTANCE
- LEVEL
- SOUND CHECK / Test tone

Setting the dynamic range compression



Select the dynamic range compression level.

This function is set to “No compression” by default.

- 1 Turn off the unit.
- 2 Use the remote control to select the desired compression level.

Compression level	Function	Operations (buttons must be pressed consecutively within three seconds.)
Compression (maximum)	Apply the maximum amount of dynamic range compression.	STEREO, VOLUME +, and then
Compression (standard)	Apply the standard amount of dynamic range compression for normal home use.	STEREO, VOLUME -, and then
No compression	Dynamic range compression is not applied.	STEREO, , and then

The indicators show the compression level applied for several seconds.

Compression level	Indicators
Compression (maximum)	 <p data-bbox="311 285 406 308">Glow (red)</p>
Compression (standard)	 <p data-bbox="311 412 422 434">Glow (white)</p>
No compression	 <p data-bbox="327 538 438 561">Glow (white)</p>

APPENDIX

When any problem appears (General)

First in trouble, check the following:

Refer to the following when the unit does not function properly.

- The power cord of the unit (center unit and subwoofer), TV and playback devices (such as BD/DVD players) are connected to AC wall outlets securely.
- The unit (center unit and subwoofer), TV and playback devices (such as BD/DVD players) are turned on.
- The connectors of each cable are securely inserted into jacks on each device.

If there is no problem with the power and cables, see the following:

- “When any problem appears (Power and system function)” (p.57)
- “When any problem appears (Audio)” (p.60)
- “When any problem appears (Bluetooth®)” (p.62)

If the problem you are experiencing is not listed or if the instructions do not help, turn off the unit, disconnect the power cord, and contact the nearest authorized Yamaha dealer or service center.

When any problem appears (Power and system function)

The power turns off suddenly

● The auto power standby function activated.

When the auto power standby function is enabled, the unit automatically turns off in any of the following situations:

- No operations have been performed for 8 hours
- BLUETOOTH or HDMI is selected as the input source, but no audio has been input to the unit or no operations have been performed with the unit for more than 20 minutes.

Turn on the unit again. If the auto power standby function is not used, disable the function. For details, see the following:

- “Setting the auto power standby function” (p.46)

● The protection circuitry has been activated. (The HDMI indicator flashes white or red.)

After confirming that all connections are made properly, turn on the unit again. If the power still turns off frequently, unplug the power cord from the AC wall outlet and contact the nearest authorized Yamaha dealer or service center.

The power cannot be turned on

- **The protection circuitry has been activated three times consecutively. (If you try to turn on the power in this condition, the HDMI indicator will flash red.)**

To protect the product, the power cannot be turned on. Unplug the power cord from the AC wall outlet and contact the nearest authorized Yamaha dealer or service center.

No operations can be performed from the unit's touch panel

- **The touch panel control is disabled.**

Enable the touch panel control. For details, see the following:
– “Enabling/disabling touch panel control (child lock function)” (p.46)

All indicators go out although the unit is turned on (it may seem that the unit is turned off)

- **The unit is configured so that indicators do not glow or flash unless the unit is being operated.**

Press DIMMER to select the desired brightness. For details, see the following:
– “Changing the brightness of the indicators (DIMMER)” (p.44)

The unit does not function correctly

- **The internal microcomputer is frozen, due to an external electric shock (such as lightning or excessive static electricity) or to a drop in the power supply voltage.**

Unplug the power cord from the AC wall outlet and plug it again.

The unit turns on by itself

- **Another Bluetooth device is being operated nearby.**

Terminate Bluetooth connection with the unit. For details, see the following:
– “Listening to music stored on a Bluetooth® device” (p.32)

The TV's 3D glasses do not work

- **The unit is blocking the TV's 3D glasses transmitter.**

Confirm the position of the TV's 3D glasses transmitter, and position the unit so that it does not obstruct the transmitter.

HDMI video is not displayed on TV screen

- **The HDMI cable is not securely connected.**

Connect the HDMI cable properly. For details, see the following:
– “Connecting a TV that supports Audio Return Channel (ARC)” (p.18)
– “Connecting a TV that does not support Audio Return Channel (ARC)” (p.19)

When the unit is turned off, video and/or audio from a playback device are not output to the TV

- **The HDMI control function is disabled.**

Enable the HDMI control function. For details, see the following:
– “Configuring the HDMI control function” (p.44)

The unit cannot be operated using the remote control

- **The unit is out of the operating range.**

Use the remote control within the operating range. For details, see the following:

– “Operating range of the remote control” (p.9)

- **The batteries are weak.**

Replace with new batteries. For details, see the following:
– “Replacing the battery in the remote control” (p.10)

- **The remote control sensor of the unit is exposed to direct sunlight or strong lighting.**

Adjust the lighting angle, or reposition the unit.

The TV cannot be operated using the TV’s remote control

- **The unit is blocking the TV’s remote control sensor.**

Position the unit so that it does not obstruct the TV’s remote control sensor.

The unit cannot be operated using the TV’s remote control

- **The HDMI control function is incorrect.**

Confirm the settings are properly configured as follows.

- The HDMI control function of the unit is enabled.
- The HDMI control function is enabled on the TV.
- Set audio output to any option other than TV.

If the unit cannot be operated with the TV’s remote control, even after the settings have been applied correctly:

- Turn off the unit and the TV, and then turn them back on again.
- Disconnect the power cord of the unit and external devices connected to the unit via HDMI cable. Plug them in again after about 30 seconds.

- **The TV and BD/DVD player are not from the same manufacturer.**

We suggest using devices such as a TV and BD/DVD player from the same manufacturer.

- **The TV does not support the unit’s functions.**

Even if your TV supports the HDMI control function, some functions may not be available. For details, see documentation supplied with your TV.

When any problem appears (Audio)

No sound

- **Another input source is selected.**

Select an appropriate input source. For details, see the following:

 - “Basic procedure for playback” (p.27)
- **The mute function is activated.**

Cancel the mute function. For details, see the following:

 - “Basic procedure for playback” (p.27)
- **The volume is too low.**

Turn up the volume. For details, see the following:

 - “Basic procedure for playback” (p.27)
- **The power cord of the unit is not connected properly.**

Make sure that the power cord of the unit is connected to an AC wall outlet securely. For details, see the following:

 - “Connecting the power cord” (p.21)
- **Input jacks on a playback device are connected.**

Connect the input jack on the unit and the output jack on the playback device.
- **Signals that the unit cannot play back are being input.**

Change the digital audio output setting on the playback device to PCM, Dolby Digital or DTS.
- **The unit is configured so that HDMI audio input signals are output from the TV.**

Configure the unit so that HDMI audio input signals are output from the unit. For details, see the following:

 - “Configuring HDMI audio output” (p.45)

- **The HDMI control function is disabled.**

When connecting a TV that supports ARC (Audio Return Channel) to the unit using an HDMI cable only, enable the HDMI control function.

To output audio signals from the unit with the HDMI control function disabled, connect the TV's audio output jack to the unit's TV input jack (optical digital) via the optical digital audio cable.

For details, see the following:

- “Configuring the HDMI control function” (p.44)
- “Connecting a TV that does not support Audio Return Channel (ARC)” (p.19)

- **Sound from an HDMI control-enabled TV is set for output from the TV's built-in speakers.**

Use the TV's HDMI settings to set audio output to any option other than the TV's built-in speakers.

No sound is coming from the subwoofer

- **The subwoofer is not connected to an AC wall outlet.**

Plug in the power cord of the subwoofer to an AC wall outlet. For details, see the following:

 - “Connecting the power cord” (p.21)
- **The protection circuitry in the subwoofer has been activated.**

To protect the product, the power of the subwoofer cannot be turned on. Unplug the power cord from the AC wall outlet and contact the nearest authorized Yamaha dealer or service center.
- **The playback source does not contain low-frequency signals.**

Play back a sound source containing low-frequency signals, and confirm that the sound is output from the subwoofer.

- **The volume is too low.**

Turn up the volume of the subwoofer. For details, see the following:

- “Basic procedure for playback” (p.27)

- **The front side of the subwoofer is blocked.**

Clear the area around the front side and the bass reflex port of the subwoofer.

- **[When the  indicator on the subwoofer flashes.] The center unit and subwoofer are not connected due to a bad wireless communication status.**

- Move the subwoofer closer to the center unit. If the issue is not resolved, move the subwoofer to a location that supports better communication (one in which the  indicator glows).
- If the communication between the center unit and subwoofer is obstructed by a metallic object or another object, change the position of the center unit and subwoofer or change the installation location of the subwoofer.
- If there is a device (microwave oven, wireless LAN, etc.) that emits radio frequency signals, move the center unit and subwoofer away from the device.

- **[When the  indicator on the subwoofer flashes.] The center unit and subwoofer are not paired.**

Pair the center unit and subwoofer manually. For details, see the following:

- “Pairing the center unit and subwoofer manually” (p.52)

If a wireless connection is not established, the unit may be malfunctioning. Unplug the power cords from the AC wall outlets and contact the nearest authorized Yamaha dealer or service center.

The volume decreases when the unit is turned on

- **The automatic volume adjustment function is activated.**

To prevent excessive loudness, the unit automatically controls its volume within a certain level when the unit is turned on. Turn up the volume as required. For details, see the following:

- “Basic procedure for playback” (p.27)

No surround effect

- **Stereo playback is selected.**

Select surround playback or 3D surround playback. For details, see the following:

- “Playback with 3D surround sound” (p.30)
- “Playback with surround sound” (p.30)

- **The volume is too low.**

Turn up the volume. For details, see the following:

- “Basic procedure for playback” (p.27)

- **The TV or playback device is set to output 2 channel audio (such as PCM) only.**

Change the digital audio output setting on the TV or playback device to multi-channel linear PCM or bitstream.

- **Sound is also heard from the TV built-in speakers.**

Set the TV volume to minimum. For details, see the following:

- “Basic procedure for playback” (p.27)

- **The listening position is too close to the unit.**

The listening position should be at some distance from the unit.

Noise is heard

- **The unit is too close to another digital or high-frequency device.**

Move those devices away from the unit.

When any problem appears (Bluetooth®)

The unit cannot be connected to a Bluetooth® device

- **Bluetooth is not selected as the input source.**

Select Bluetooth as the input source. For details, see the following:

 - “Listening to music stored on a Bluetooth® device” (p.32)
- **The unit is too far away from the Bluetooth device.**

Move the Bluetooth device closer to the unit.
- **A device emitting electromagnetic waves (such as a microwave oven, a wireless device and so on) may be located nearby.**

Do not use the unit near devices that emit electromagnetic waves.
- **The Bluetooth device you are using may not support the A2DP profile.**

Use a Bluetooth device that supports the A2DP profile.
- **The connection profile registered in the Bluetooth device may not be functioning correctly.**

Delete the connection profile in the Bluetooth device, and then connect the Bluetooth device to the unit.
- **The passkey for devices such as a Bluetooth adapter is not “0000”.**

Use a Bluetooth device with a passkey of “0000”.
- **The unit is already connected to another Bluetooth device.**

Terminate the current Bluetooth connection, and then connect to the new device.

No sound can be heard, or the sound cuts off intermittently from a Bluetooth® device

- **The volume on the Bluetooth device may be too low.**
Raise the volume on the Bluetooth device.
- **Bluetooth is not selected as the input source.**
Select Bluetooth as the input source. For details, see the following:
 - “Listening to music stored on a Bluetooth® device” (p.32)
- **Playback on the Bluetooth device has not been performed.**
Perform playback on the Bluetooth device.
- **The sound output on the Bluetooth device may not be set to the unit.**
Select the unit as the output destination on the Bluetooth device.
- **The connection to the Bluetooth device was terminated.**
Connect with the Bluetooth device one more time.
- **The unit may be too far away from the Bluetooth device.**
Move the Bluetooth device near the unit.
- **A device emitting electromagnetic waves (such as a microwave oven, a wireless device and so on) may be located nearby.**
Do not use the unit near devices that emit electromagnetic waves.

When any problem appears (Network trouble)

The network feature does not function

- **The network parameters (IP address) have not been obtained properly.**
Enable the DHCP server function on the wireless router.
- **The unit does not support IPv6 network.**
Connect IPv4 network.

The unit cannot connect to the Internet via a wireless router (access point)

- **The wireless router (access point) is turned off.**
Turn on the wireless router.
- **The unit and the wireless router (access point) are too far apart.**
Place the unit and the wireless router (access point) closer to each other.
- **There is an obstacle between the unit and the wireless router (access point).**
Move the unit and the wireless router (access point) in a location where there are no obstacles between them.
- **The wireless router (access point) is set to use the wireless channel 14.**
Change settings of the wireless router (access point) to use one of the wireless channels from 1 to 13.

Wireless network is not found

- **Microwave ovens or other wireless devices might disturb the wireless communication.**

Turn off these devices or move them farther away from the unit and wireless router. If the wireless router supports the 5 GHz band, connect the unit to the network using the 5 GHz band.

- **Access to the network is restricted by the firewall settings of the wireless router (access point).**

Check the firewall setting of the wireless router (access point).

The unit does not detect the media server (computer/NAS)

- **The media sharing setting is not correct.**

Configure the sharing setting and select the unit as a device to which music contents are shared.

- **Some security software installed on your media server is blocking the access of the unit to your media server.**

Check the settings of security software installed on your media server.

- **The unit and media server are not in the same network.**

Check the network connections and router's settings, and then connect the unit and the media server to the same network.

The files in the media server (computer/NAS) cannot be viewed or played back

- **The files are not supported by the unit or the media server.**

Use the file format supported by both the unit and the media server. For information about the file formats supported by the unit, see the following:

- “Supported file formats” (p.71)

The Internet radio cannot be played

- **The selected Internet radio station is currently not available.**

There may be a network problem at the radio station, or the service may have been stopped. Try the station later or select another station.

- **The selected Internet radio station is currently broadcasting silence.**

Some Internet radio stations broadcast silence at certain of times of the day. Try the station later or select another station.

- **Access to the network is restricted by the firewall settings of your network devices (such as the router).**

Check the firewall settings of your network devices. The Internet radio can be played only when it passes through the port designated by each radio station. The port number varies depending on the radio station.

The iOS device does not recognize the unit when using AirPlay

- **The unit is connected to a multiple SSID router.**

Access to the unit might be restricted by the network separation function on the router. Connect the iOS device to the SSID which can access the unit. (Connect it to the Primary SSID at the top of the list.)

The MusicCast CONTROLLER app does not detect the unit

- **The unit and mobile device are not in the same network.**

Check the network connections and router's settings, and then connect the unit and mobile device to the same network.

- **The unit is connected to a multiple SSID router.**

Access to the unit might be restricted by the network separation function on the router. Connect the mobile device to the SSID which can access the unit. (Connect it to the Primary SSID at the top of the list.)

- **The wireless (Wi-Fi) connection is disabled.**

Enable a wireless (Wi-Fi) connection. For details, see the following:

- “Enabling/disabling a wireless (Wi-Fi) connection” (p.50)

Firmware update via the network is failed

- **It may not be possible depending on the condition of the network.**

Update the firmware via the network again or use a USB memory device.

Specifications

Specifications (ATS-CU4080)

Amplifier section

Maximum rated output power

- Front L/R 50 W × 2ch

Speaker section

Front L/R

- Type Acoustic suspension type (non-magnetic shielding)
- Driver 4.6 cm (1-3/4") cone × 4
- Frequency response 160 Hz to 9 kHz
- Impedance 4 Ω (8 Ω × 2)

Tweeter

- Driver 2.5 cm (1") dome × 2
- Frequency response 9 kHz to 23 kHz
- Impedance 4 Ω

Decoder

Supported audio signal (HDMI/optical input) PCM (up to 5.1ch)
Dolby Digital (up to 5.1ch)
DTS Digital Surround (up to 5.1ch)

Input jacks

HDMI 1 (HDMI IN)

Digital (optical) 1 (TV)

Analog (3.5 mm stereo mini) 1 (ANALOG)

Output jacks

HDMI 1 (HDMI OUT (ARC))

Other jacks

USB 1 (UPDATE ONLY)

LAN 1 (NETWORK)

Bluetooth

Function Sink function (source device to this unit)

Bluetooth version Ver 4.2

Supported profiles A2DP, AVRCP

Supported codecs Sink function: SBC, AAC

Bluetooth class Bluetooth Class 2

Range (line-of-sight) Approx. 10 m (33 ft)

Supported content protection method SCMS-T (sink function)

[U.K. and Europe models]

- Radio frequency 2402 MHz to 2480 MHz
- Maximum output power (EIRP) 6.5 dBm (4.5 mW)

Network

Ethernet standard 100BASE-TX/10BASE-T

Supported codecs WAV (PCM format only) /AIFF/FLAC: up to 192 kHz
ALAC: up to 96 kHz
MP3/WMA/MPEG-4 AAC: up to 48 kHz

PC client function
AirPlay 2 supported
Internet Radio

Wi-Fi function

-
- Wireless LAN standards: IEEE 802.11 a/b/g/n/ac*
* 20 MHz channel bandwidth only
 - Radio frequency band 2.4 GHz/5 GHz
 - Available security method: WEP, WPA2-PSK (AES), Mixed Mode

[U.K. and Europe models]

- Radio frequency
 - 2.4 GHz band 2402 MHz to 2482 MHz (20 MHz)
 - 5 GHz band 5170 MHz to 5250 MHz (20 MHz)
 - 5250 MHz to 5330 MHz (20 MHz)
 - 5490 MHz to 5710 MHz (20 MHz)
 - 5735 MHz to 5835 MHz (20 MHz)
- Maximum output power (EIRP)
 - 2.4 GHz band 19.2 dBm (83.2 mW)
 - 5 GHz band 5170 MHz to 5250 MHz (20 MHz): 21.5 dBm (141.3 mW)
 - 5250 MHz to 5330 MHz (20 MHz): 21.8 dBm (151.4 mW)
 - 5490 MHz to 5710 MHz (20 MHz): 24.1 dBm (257.0 mW)
 - 5735 MHz to 5835 MHz (20 MHz): 13.5 dBm (22.4 mW)

General

-
- Power supply
- [U.S.A. and Canada models] AC 120 V, 60 Hz
 - [Australia model] AC 240 V, 50 Hz
 - [Europe, Asia, and Russia models] AC 110 to 240 V, 50/60 Hz
 - [U.K. model] AC 230 V, 50 Hz
 - [Taiwan model] AC 110 V, 60 Hz
 - [China model] AC 220 V, 50 Hz
 - [Korea model] AC 220 V, 60 Hz

Power consumption 30 W

Standby power consumption

- [U.S.A., Canada and Taiwan models]
 - HDMI control off, network standby off 0.4 W
 - HDMI control off, network standby on (Wired/Wi-Fi/Bluetooth) 1.6/1.8/1.7 W
 - HDMI control on, network standby off 0.7 W
 - HDMI control on, network standby on 2.2 W
- [U.K. and Europe models and other models]
 - HDMI control off, network standby off 0.4 W
 - HDMI control off, network standby on (Wired/Wi-Fi/Bluetooth) 1.6/1.8/1.7 W
 - HDMI control on, network standby off 0.7 W
 - HDMI control on, network standby on 2.2 W

Dimensions (W x H x D)

980 × 60 × 110.5 mm
(38-5/8" × 2-3/8" × 4-3/8")

Weight 2.7 kg (6 lbs)

NOTE

- The contents of this manual apply to the latest specifications as of the publishing date. To obtain the latest manual, access the Yamaha website then download the manual file.
- With an advanced energy saving design, this product achieves a low power consumption of not more than two watts when in Network Standby mode.



Specifications (NS-WSW43)

The specifications of the subwoofer are as follows.

Amplifier section

Maximum rated output power 100 W

Speaker section

- Type Bass reflex type (non-magnetic shielding type)
- Driver 16 cm (6-1/2") cone × 1
- Frequency response 40 Hz to 160 Hz
- Impedance 2 Ω
- Radio frequency band 2.4 GHz
- Transmission range 10 m ([33 ft] without interference)

[U.K. and Europe models]

- Radio frequency 2405.35 MHz to 2477.35 MHz
- Maximum output power (EIRP) 9.0 dBm (8 mW)

General

Power supply

- [U.S.A. and Canada models] AC 120 V, 60 Hz
- [Europe, Asia, and Russia models] AC 110 to 240 V, 50/60 Hz
- [U.K. model] AC 230 V, 50 Hz
- [Taiwan model] AC 110 V, 60 Hz
- [Korea model] AC 220 V, 60 Hz
- [China model] AC 220 V, 50 Hz
- [Australia model] AC 240 V, 50 Hz

Power consumption 19 W

Standby power consumption

- [U.S.A., Canada and Taiwan models] 0.8 W
- [U.K. and Europe models and other models] 0.8 W

Dimensions (W × H × D) 180 × 417 × 405 mm
(7-1/8" × 16-3/8" × 16)

Weight 9.4 kg (21 lbs)

NOTE

The contents of this manual apply to the latest specifications as of the publishing date. To obtain the latest manual, access the Yamaha website then download the manual file.

Supported HDMI audio and video formats

The following HDMI audio and video formats can be used by the unit.

Audio signals

Audio signal types	Audio signal formats	Compatible media
2ch Linear PCM	2ch, 32 kHz to 192 kHz, 16/20/24 bit	CD, DVD-Video, DVD Audio
Multi-ch Linear PCM	6ch, 32 kHz to 192kHz, 16/20/24 bit	DVD-Audio, Blu-ray disc, HD DVD
Bitstream	Dolby Digital, DTS	DVD-Video

Video signals

The unit is compatible with the following video signals.

- Deep Color
- x.v.Color
- 3D video signal
- High Dynamic Range (HDR) video
 - HDR10
 - Dolby Vision
 - HLG

The unit is compatible with the following resolutions.

- VGA
- 480i/60 Hz
- 480p/60 Hz
- 576i/50 Hz
- 576p/50 Hz
- 720p/60 Hz, 50 Hz
- 1080i/60 Hz, 50 Hz

- 1080p/60 Hz, 50 Hz, 30 Hz, 25 Hz, 24 Hz
- 4K/60 Hz, 50 Hz, 30 Hz, 25 Hz, 24 Hz

NOTE

- Refer to documentation supplied with the playback device, and set the device appropriately.
- When GPPM copy-protected DVD-Audio is played back, video and audio signals may not be output depending on the type of the DVD player.
- The unit is not compatible with HDCP-incompatible HDMI or DVI devices. Refer to documentation supplied with the HDMI or DVI device for HDCP compatibility.
- To decode audio bitstream signals on the unit, set the input source device appropriately so that the device outputs the bitstream audio signals directly (does not decode the bitstream signals on the device). Refer to documentation supplied with the device for details.
- The resolution of transmitted video signal varies according to specifications of the TV connected to the unit.
- The contents of this manual apply to the latest specifications as of the publishing date. To obtain the latest manual, access the Yamaha website then download the manual file.

Supported digital audio formats

The following digital audio formats can be used by the unit.

Optical

Audio signal types	Audio signal formats	Compatible media
2ch Linear PCM	2ch, 32 kHz to 96 kHz, 16/20/24 bit	CD, DVD-Video, DVD Audio, etc.
Bitstream	Dolby Digital, DTS	DVD-Video, etc.

HDMI (ARC)

Audio signal types	Audio signal formats	Compatible media
2ch Linear PCM	2ch, 32 kHz to 96 kHz, 16/20/24 bit	TV
Bitstream	Dolby Digital, DTS	TV

NOTE

The contents of this manual apply to the latest specifications as of the publishing date. To obtain the latest manual, access the Yamaha website then download the manual file.

Supported file formats

The following file formats can be used by the unit.

File	Sampling frequency (kHz)	Quantization bits (bit)	Bitrate (kbps)	Number of channels	Support for gapless playback
WAV*	32/44.1/48/ 88.2/96/ 176.4/192	16/24	-	2	✓
MP3	32/44.1/48	-	8 to 320	2	-
WMA	32/44.1/48	-	8 to 320	2	-

File	Sampling frequency (kHz)	Quantization bits (bit)	Bitrate (kbps)	Number of channels	Support for gapless playback
MPEG-4 AAC	32/44.1/48	-	8 to 320	2	-
FLAC	32/44.1/48/ 88.2/96/ 176.4/192	16/24	-	2	✓
ALAC	32/44.1/48/ 88.2/96	16/24	-	2	✓
AIFF	32/44.1/48/ 88.2/96/ 176.4/192	16/24	-	2	✓

* Linear PCM format only. 32 bit-float files cannot be played back.

- The playable file formats differ depending on the software installed on media servers (computers/NAS). Refer to the instruction manual of the server software for details.
- Digital Rights Management (DRM) contents cannot be played back.

Information for qualified contractors or dealers

Mounting the center unit on a wall

Mount the center unit on a wall using the screw holes on the rear panel.

CAUTION

- To prevent the center unit from falling, attach it to a wall constructed of drywall (plasterboard).
- Make sure you use screws (sold separately) that can support the weight of the installation. Using clamps other than specified screws, such as short screws, nails, and two-sided tape, may cause the center unit to fall.
- Fix the cables in place where they will not become loose. If your foot or hand accidentally gets caught on a loose cable, the center unit may fall.
- Do not lean on the unit or apply excessive force to the top of the center unit. Doing so may cause the center unit to fall.
- Check that the center unit is fixed securely after the installation. Yamaha will bear no responsibility for any accidents caused by improper installations.

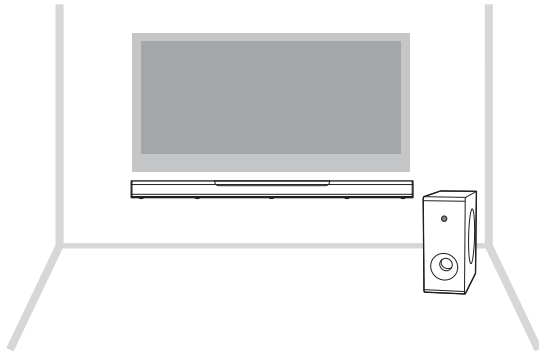

- 1 Attach the mounting template (supplied) on a wall and mark for the screw holes.**

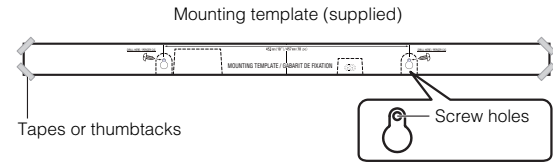

- 2 Remove the mounting template from the wall, and then install screws (sold separately) at the points marked on the wall.**

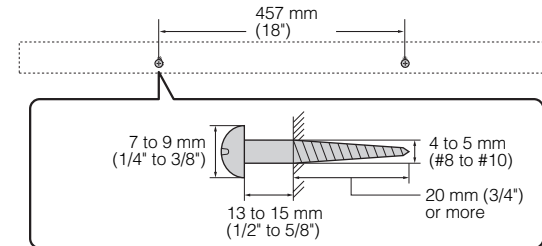

3 Hang the center unit on the screws.

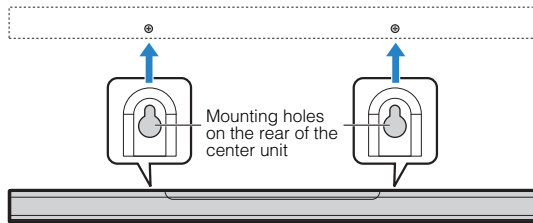

YAMAHA CORPORATION

10-1 Nakazawa-cho, Naka-ku, Hamamatsu, 430-8650 Japan

Yamaha Global Site
<https://www.yamaha.com/>

Yamaha Downloads
<https://download.yamaha.com/>

Manual Development Group
© 2018 Yamaha Corporation

Published 06/2019 NVOD-D0

AV17-0363