

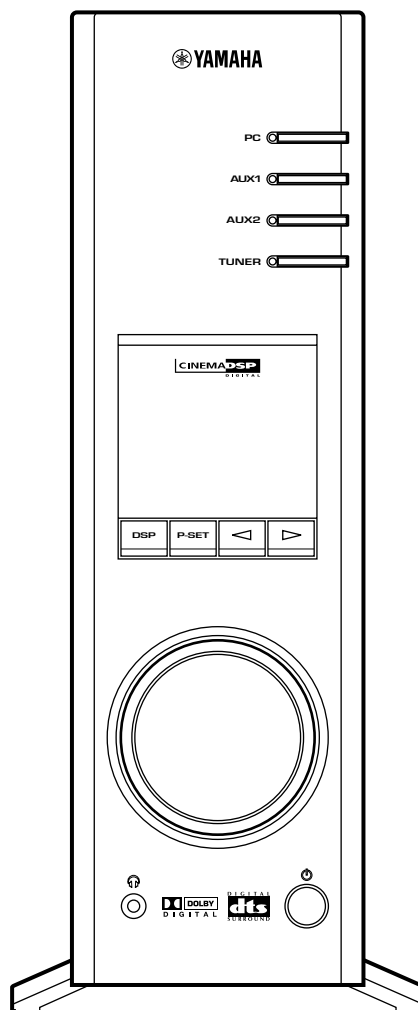

PERSONAL RECEIVER

RP-U200

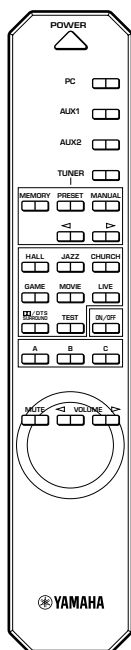

OPERATION MANUAL

MANUEL D'UTILISATION

BEDIENUNGSANLEITUNG

BRUKSANVISNING

MANUALE DELLE ISTRUZIONI

MANUAL DE OPERACIONES

BEDIENINGSHANDLEIDING

INTRODUCTION

About this manual

- This manual explains how to operate this unit. Refer to the separate “**SET UP MANUAL**” for how to connect this unit with other equipment, and to install the Application Software, etc. to your computer from the supplied CD-ROM.
- This manual mainly explains how to operate this unit using the front panel of this unit and the supplied remote control.
- When this unit and your computer are connected with the USB cable, and the supplied Application Software is installed on the computer, you can operate this unit from the computer using the Application Software. Refer to the online help of the Application Software for how to use the Application Software.

The Application Software extends the use of this unit with additional functions which cannot be used with the front panel keys or the remote control. This manual introduces those functions by the following style.

Example:



■ Adjusting USB MIX LEVEL

When an input other than the USB terminal is selected, you can listen to the mixed sound signals from the selected input and from the USB terminal. Also, the mixing ratio of the signals from the USB terminal can be adjusted.

* Refer to the online help of the Application Software for details.



This manual also offers brief explanations about the functions available with the Application Software on page 22–27. Refer to the online help of the Application Software for details of how to use the functions.

Features

- **This unit brings high-quality audio to your computer**
This unit is a multimedia amplifier that brings you a new level of audio enjoyment. This unit has a USB port for connection with a personal computer. The USB interface allows remote control of this unit from your computer and control of sound data sent from your computer.
- **Equipped with a five-channel power amplifier**
This unit has a five-channel power amplifier for reproducing surround sound fields of Dolby Digital*, DTS** and Yamaha CINEMA-DSP effectively. You can enjoy a full-scale home theater sound simply by adding the optional Yamaha speaker system NS-U40P and an optional subwoofer to this unit.
- **Equipped with Dolby Digital and DTS decoders**
This unit reproduces multichannel sources encoded with Dolby Digital* or DTS** faithfully by using the built-in Dolby Digital and DTS decoders. You can now experience the sound scale and the realistic sensation of actual theaters in your home.
- **The newly-developed Yamaha Near-Field Cinema DSP (Digital Sound Field Processor)**
Various DSP sound field programs allow you to select the program suitable for the selected input source. You can experience the sound fields of famous concert halls, movie theaters, etc. around the world in your home. The DSP sound effects are also available for headphone listening.
- **Compatible with various USB audio functions**
This unit is compatible with the following audio signals received via a USB connection:
multi-channel (two, four and six channels) audio, high quality digital audio of 24 bit/48 kHz and Dolby Digital-encoded signals. (Some operating systems and software programs do not support this feature.)
- **Various inputs/outputs and easy operation**
This unit is equipped with various input and output terminals for both analog and digital signals, making it ideal as a control center for other audio equipment, such as a personal computer, CD player and MD recorder. The supplied remote control makes operation easy, and the supplied Application Software allows control of this unit from your computer including detailed settings.
- **Compatible with Virtual Dolby Digital and DTS Virtual 5.1**
By employing the Virtual 3D technology, this unit reproduces multi-channel sources such as Dolby Digital and DTS providing realistic surround effects even with just two speakers.

CONTENTS

CAUTION	2	CAUTION
OUTLINE OF THIS UNIT		OUTLINE OF THIS UNIT
Main features of this unit	3	
Dolby Digital and DTS	4	
Virtual 3D	5	
Digital Sound Field Processing (DSP)	5	
CONTROLS AND THEIR FUNCTIONS		CONTROLS & THEIR FUNCTIONS
Front panel & Remote control	6	
About the display	8	
BASIC OPERATION		BASIC OPERATION
Playing a source	9	
Using sound field programs	11	
Recording	12	
LISTENING TO AN FM BROADCAST		LISTENING TO AN FM BROADCAST
Tuning into an FM station	14	
Using the presets	16	
ADVANCED OPERATION		ADVANCED OPERATION
Adjusting the speaker balance ...	19	
Setting USB channel	20	
Operating this unit with the Application Software	22	
APPENDIX		APPENDIX
Troubleshooting	28	
Specifications	31	



Manufactured under license from Dolby Laboratories.

"Dolby", "AC-3", "Pro Logic" and the double-D symbol are trademarks of Dolby Laboratories.

Confidential Unpublished Works. ©1992–1997 Dolby Laboratories, Inc. All rights reserved.



Manufactured under license from Digital Theater Systems, Inc. US Pat. No. 5,451,942 and other world-wide patents issued and pending. "DTS", "DTS Digital Surround", are trademarks of Digital Theater Systems, Inc. Copyright 1996 Digital Theater Systems, Inc. All Rights Reserved.

CAUTION: Read this before operating this unit

1. To assure the finest performance, please read this manual carefully. Keep it in a safe place for future reference.
2. Install this unit in a cool, dry, clean place – away from windows, heat sources, sources of excessive vibration, dust, moisture and cold. Avoid sources of humming (transformers, motors). To prevent fire or electric shock, do not expose the unit to rain or water.
3. Never open the cabinet. If something drops into the set, contact your dealer.
4. Do not use force on switches, controls or connection wires. When moving the unit, first disconnect the power plug and the wires connected to other equipment. Never pull the wires themselves.
5. The openings on the unit cover assure proper ventilation of the unit. If these openings are obstructed, the temperature inside the unit will rise rapidly; therefore, avoid placing objects against these openings. To prevent fire or damage, install the unit in a well-ventilated area.
<Europe and U.K. models only>
To prevent fire or damage, be sure to allow a space of at least 10 cm behind, 10 cm on both sides and 10 cm above the top panel of the unit.
6. The voltage used must be the same as that specified on this unit. Using this unit with a higher voltage than specified is dangerous and may result in fire or other accidents. YAMAHA will not be held responsible for any damage resulting from use of this unit with a voltage other than that specified.
7. Always set the volume to minimum before starting audio playback. Increase the volume gradually to an appropriate level after playback has been started.
8. Do not attempt to clean the unit with chemical solvents as this might damage the finish. Use a clean, dry cloth.
9. Be sure to read the “TROUBLESHOOTING” section regarding common operating errors before concluding that the unit is faulty.
10. When not planning to use this unit for a long period (i.e., vacation, etc.), disconnect the AC power plug from the wall outlet.
11. To prevent lightning damage, disconnect the AC power plug when there is an electric storm.
12. Grounding or polarization – Precautions should be taken so that the grounding or polarization of appliances is not defeated.

For U.K. customers

If the socket outlets in the home are not suitable for the plug supplied with this appliance, it should be cut off and an appropriate 3 pin plug fitted. For details, refer to the instructions described below.

Note: The plug severed from the mains lead must be destroyed, as a plug with bared flexible cord is hazardous if engaged in a live socket outlet.

SPECIAL INSTRUCTIONS FOR U.K. MODEL

IMPORTANT:

THE WIRES IN MAINS LEAD ARE COLOURED IN ACCORDANCE WITH THE FOLLOWING CODE:

Blue: NEUTRAL

Brown: LIVE

As the colours of the wires in the mains lead of this apparatus may not correspond with the coloured markings identifying the terminals in your plug, proceed as follows: The wire which is coloured BLUE must be connected to the terminal which is marked with the letter N or coloured BLACK. The wire which is coloured BROWN must be connected to the terminal which is marked with the letter L or coloured RED. Making sure that neither core is connected to the earth terminal of the three pin plug.

For Canadian Customers

To prevent electric shock, match wide blade of plug to wide slot and fully insert.

This Class B digital apparatus complies with Canadian ICES-003.

When this unit is turned off by pressing the power switch on the front panel or the POWER key on the remote control, this unit turns into the standby mode. In this mode, this unit is designed to consume a small amount of power. This unit's power supply is completely cut off from the AC line only when the AC power cord is disconnected.

OUTLINE OF THIS UNIT

Main features of this unit

Using Yamaha's unique DSP technology, this unit can bring excitement and realism to any audio source by simulating the acoustic environments of concert halls, movie theaters, and so on. With its stylish, vertical design, this unit allows you to use various audio sources, including the built-in FM tuner, your computer, CD player, MD or tape deck, as shown below.

Although this unit can be used as part of a typical hi-fi system, connecting it to your computer via the USB terminal, and running the supplied Application Software, allows you to remotely control this unit from your computer and make some adjustments and settings.

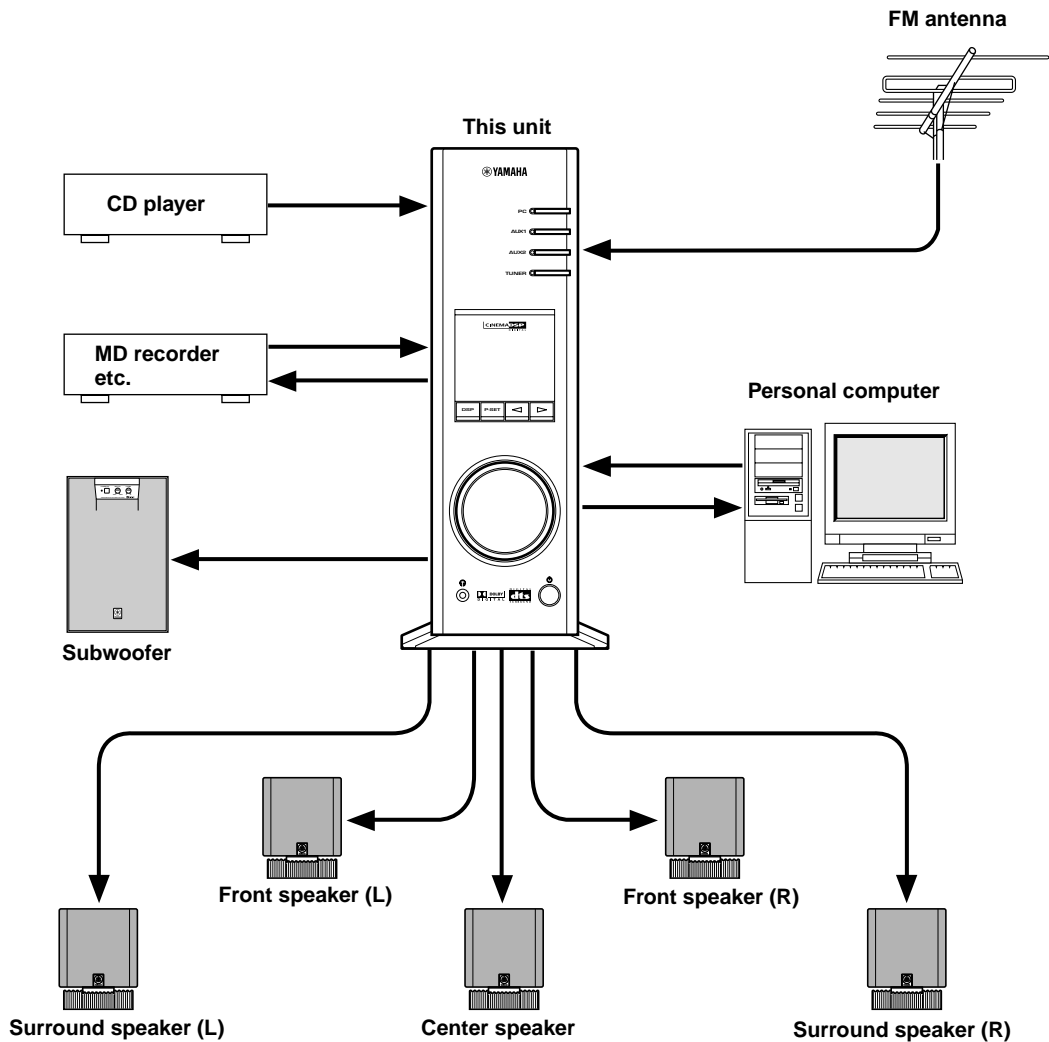

* Refer to the separate "SET UP MANUAL" for connections.

Dolby Digital and DTS

This unit features a built-in Dolby Digital decoder and a DTS decoder for reproducing surround sounds of sources encoded with Dolby Digital or DTS. With such state-of-the-art technologies, this unit can bring the same audio experience to your home as they have brought to feature films in quality theaters around the world.

Take some time now to read more about these features and enjoy the new experiences this system brings to your home theater.

■ Dolby Surround

Dolby Surround uses four discrete channels and five speakers to reproduce realistic and dynamic sound effects: two main channels (left and right), a center channel for dialog, and a surround channel for special sound effects. The surround channel reproduces sound within a narrow frequency range.

Most video tapes and laser discs include Dolby Surround encoding, as do many TV and cable broadcasts. The Dolby Pro Logic decoder built into this unit employs a digital signal processing system that stabilizes each channel for even more accurate sound positioning than is available with standard analog processors.

■ Dolby Digital

Dolby Digital is a digital surround sound system that provides completely independent multi-channel audio to you. Dolby Digital provides five full-range channels in what is sometimes referred to as a "3/2" configuration: three front channels (left, center and right), and two surround channels. A sixth bass-only effect channel is also provided for output of LFE (low frequency effect), or low bass effects that are independent of other channels. (This is called the "LFE channel".) This channel is counted as 0.1, thus giving rise to the term 5.1 channels in total.

The wide dynamic range of sound reproduced by the five full-range channels and precise sound orientation by digital sound processing provides listeners with excitement and realism that have never been experienced before.

■ DTS (Digital Theater System) Digital Surround

DTS was developed to replace the analog soundtracks of movies with six discrete channels of digital soundtracks, and it is now installed in many theaters around the world. The DTS digital playback system changed the way we experienced movies in theaters with six discrete channels of superb digital audio. DTS technology, through intense research and development, has made it possible to deliver similar encode/decode discrete technology to home audio surround-sound entertainment. DTS Digital Surround is an encode/decode system which delivers six channels of master-quality, 20-bit audio; technically, it offers 5.1 channels, which means 5 full-range (left, center, right and two surround) channels, plus a subwoofer (LFE) channel (as "0.1"). It is compatible with the 5.1 speaker configurations that are currently available for home theater systems.

Virtual 3D

Surround sound typically requires several speakers situated in front of and behind the listening position, which requires a substantial amount of space that may not always be available.

In addition to ordinary surround sound reproduction using several speakers, this unit enables you to enjoy surround sound effects with only two speakers by using Yamaha's unique "Virtual 3D" (three-dimensional) technology.

Virtual 3D, which is used by this unit's sound field programs, simulates the surround effect provided by surround and center speakers, creating "virtual" surround speakers, as shown, so even with only two front speakers, you can still enjoy surround sound.

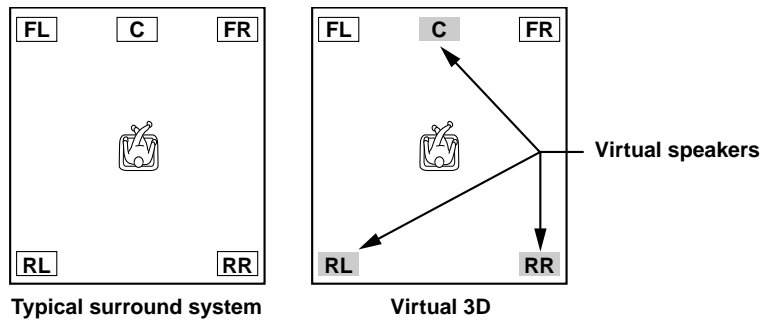

Digital Sound Field Processing (DSP)

When you listen to a performance in a concert hall, jazz club, or other live music venue, you not only hear the direct sound coming from the musical instruments and singers, but also the "early reflections" and natural reverberation. Early reflections are the initial sound waves that bounce off the floor, ceiling, and walls. Natural reverberation is made up of sound waves that gradually attenuate as they bounce repeatedly off multiple surfaces.

Since the way you hear early reflections and reverberation depends on the shape and size of the building as well as the material and construction of the walls and ceiling, each venue has its own unique "sound," called its "sound field." At Yamaha, we have measured all the elements that make up a typical sound field—direction and level of the reflections, band-width characteristics, and delay times—at famous concert halls and opera houses around the world. The information gained in this process has been converted into programs that can be reproduced using Yamaha's DSP technology. Using its on-board DSP, this unit can process any audio source and recreate the atmosphere of the original venue.

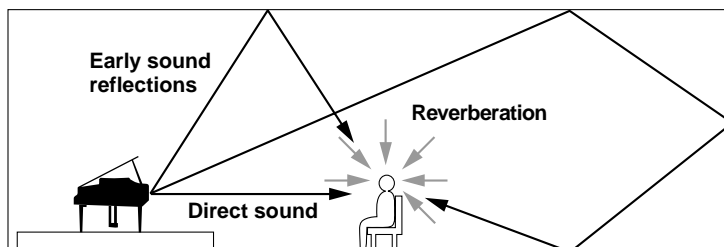

CONTROLS AND THEIR FUNCTIONS

Front panel & Remote control

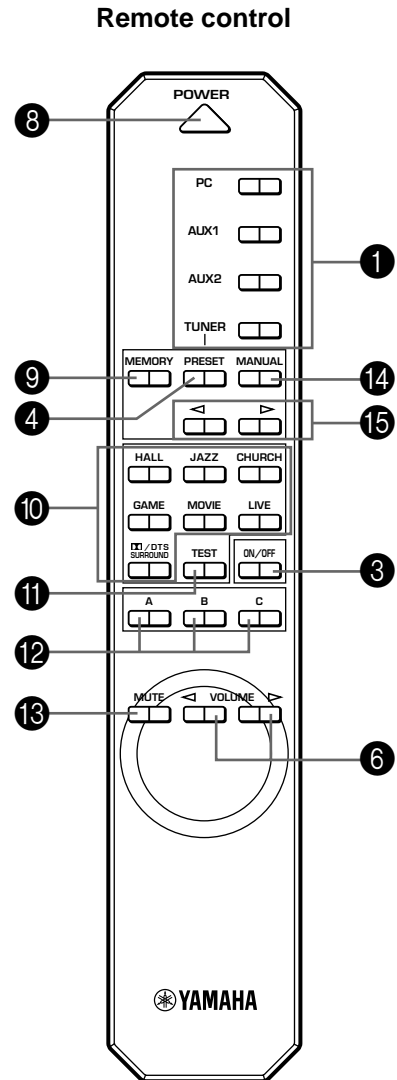
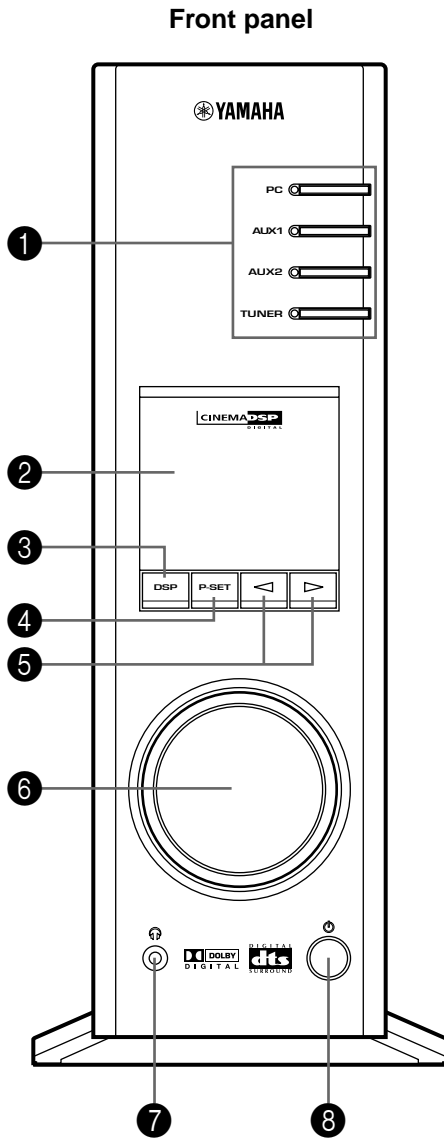

1 Input selectors & indicators

These four keys, explained below, are used to select the input source. The indicator of the selected source lights up.

● PC key

This key selects your computer as the input source. Pressing this key repeatedly selects the signals received at the USB, digital (DIGITAL PC COAX IN or DIGITAL PC OPT IN) or analog (ANALOG PC IN) input. The DIGITAL PC OPT IN has priority over the DIGITAL PC COAX IN, so if you connect to both inputs, the signal received at the DIGITAL PC OPT IN is used.

● AUX1 key

This key selects the equipment connected to the ANALOG AUX 1 IN or DIGITAL AUX 1 OPT IN connector as the input source. Pressing this key repeatedly selects the digital or analog input.

● AUX2 key

This key selects the equipment connected to the ANALOG AUX 2 IN connectors as the input source.

● TUNER key

This key selects the built-in FM tuner as the input source. If the tuner is already selected, this key toggles the reception mode between FM auto stereo and FM monaural.

2 Display

The display shows various settings, selected input source, sound field program and various other information.

3 DSP key [front panel]**ON/OFF key [remote control]**

This key activates the sound field programs produced by the internal DSP.

4 P-SET key (Ⓟ) [front panel]**PRESET key [remote control]**

This key changes the display status of the built-in FM tuner from the frequency display mode to the preset tuning mode.

If the tuner is already in the preset tuning mode, each press of this key changes the group of preset stations (A, B, C, D, E).

* This key works only when the tuner is selected as the input source.

5 </> (Down/Up) keys

These keys are used for selecting sound field programs, changing station frequencies, selecting preset station numbers, etc.

6 Volume control [front panel]**<VOLUME> (Down/Up) keys [remote control]**

These control and keys adjust the speaker and headphone volume. The volume cannot be adjusted when this unit is in the standby mode.

7 Headphone jack

Stereo headphones can be connected to this mini-jack for private listening, with Virtual 3D effects specifically tailored for headphone listening.

8 Power switch (Ⓟ) [front panel]**POWER key [remote control]**

Each click of this switch changes the status of this unit between standby mode and power on.

* In the standby mode, this unit can be turned on remotely from your computer, using the supplied Application Software. Note that this unit uses a small amount of power in the standby mode.

9 MEMORY key

This key is used to store a desired station in the memory.

* This key works only when the tuner is selected as the input source.

10 Sound field program selector keys

Each of these keys selects the corresponding sound field program.

11 TEST key

This key is used to output a test tone. The test tone is used when adjusting the volume balance among all speakers in the system including the virtual surround speakers. (Refer to page 19 for details.)

12 Custom keys (A, B, C)

These keys are available when this unit and your computer are connected with the USB cable, and the supplied Application Software is installed on the computer.

Each of these keys can be programmed with a set of commands (input selector, sound field program, volume setting, etc.) by using the Application Software. After storing, simply pressing each key will execute the stored command.

* Refer to the online help of the Application Software for details.

13 MUTE key

This key is used to cut off sound output temporarily. Turning the volume control on the front panel or pressing the **VOLUME** keys on the remote control restores sound output. Pressing this key again also restores sound output.

* Sound output will also be restored by changing the status of this unit between standby and power-on, changing the input source or the sound field program, and so on.

14 MANUAL key

This key changes the display status of the built-in FM tuner from the preset tuning mode to the frequency display mode.

* This key works only when the tuner is selected as the input source.

15 Tuning </> (Down/Up) keys

These keys work in the following ways according to the status of the tuner.

In the frequency display mode:

Each press of **▷** selects a higher frequency and **◁** selects a lower frequency.

In the preset tuning mode:

Each press of **▷** selects a higher preset station number and **◁** selects a lower preset station number.

About the display

This section explains what the various display indicators mean.

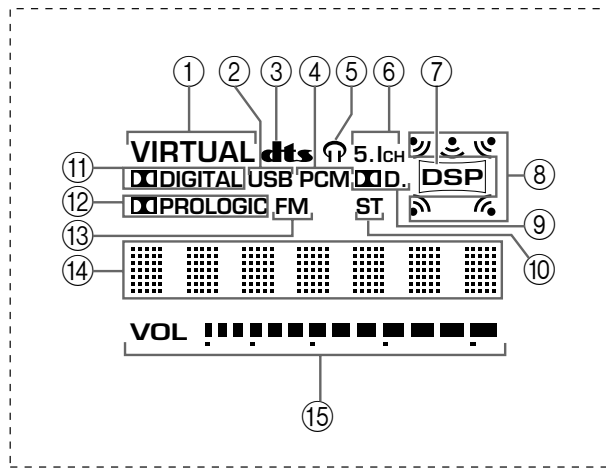

- ① **VIRTUAL**
This indicator appears when this unit is using Virtual 3D.
- ② **USB**
This indicator appears when audio signals are sent or received via the USB terminal.
* If you use a Macintosh computer, this indicator is always illuminated when this unit is connected to the computer via the USB terminals.
- ③ **dts (DTS)**
This indicator appears when an input signal is decoded with DTS.
- ④ **PCM**
This indicator appears when a PCM digital audio signal is selected as the input source.
- ⑤ **Headphones icon**
This indicator appears when headphones are connected to the headphone jack of this unit.
- ⑥ **5.1CH**
This indicator appears when a 5.1 channel digital audio signal is selected as the input source.
- ⑦ **DSP**
This indicator appears when the DSP is processing the input signal.
- ⑧ **Sound output indicator**
This indicator shows the currently used speakers. A red dot shows that the corresponding speaker is currently used, or the speaker is set for use in the Application Software. The  mark shows that sound is outputted.
* When using the test tone, a red dot shows the channel currently outputting the test tone.
* When using headphones, only the two dots for the left and right front speakers appear regardless of the setting in "Speaker Settings".
- ⑨ **D (Dolby Digital icon)**
This indicator appears when an audio signal encoded with Dolby Digital is selected as the input source.
- ⑩ **ST**
This indicator appears when a stereo broadcast is received in stereo mode.
- ⑪ **D (DOLBY) DIGITAL**
This indicator appears when an input signal is decoded with Dolby Digital.
- ⑫ **D (DOLBY) PROLOGIC**
This indicator appears when an input signal is decoded with Dolby ProLogic.
- ⑬ **FM**
This indicator appears when the built-in FM tuner is selected as the input source.
- ⑭ **Multi-information display**
Various messages and information appear here.
- ⑮ **VOL (volume)**
This indicator graphically displays the volume level setting.

Note

The indicators **dts**, "5.1CH" and **D** will not appear when sound signals are decoded on the computer (by using DVD-playback software, etc.).

BASIC OPERATION

Playing a source

This section explains how to turn on this unit and select input sources. If any external audio equipment is connected to this unit, turn it on first.

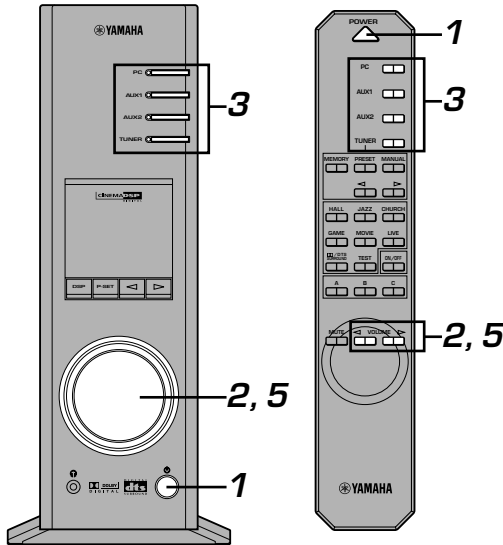

1 Turn on this unit.

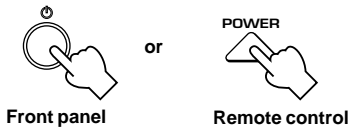

The message “Hello” appears for a few seconds, and this unit returns to the state in which it was last used (e.g., the input source that was selected when this unit was turned off is selected).

2 Decrease the volume to minimum (MIN).

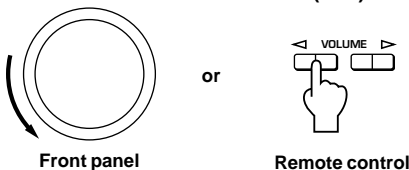

3 Select an input source by using the input selector keys.

The corresponding indicator on the front panel lights up.

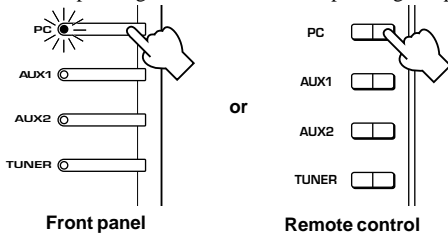

Refer to the explanation on the right side for details about using the input selector keys.

4 Start the selected input source.

Refer to “Listening to an FM broadcast” on pages 14–18 about how to tune into a desired station.

5 Adjust the volume to the desired level.

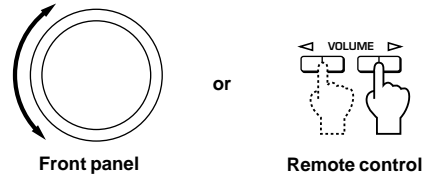

6 As you prefer, use a sound field program.

Refer to page 11 for details about the sound field programs.

About the input selector keys

Each of the input selector keys selects the following input signals.

PC: Press the **PC** key repeatedly to select the PC inputs: “USB”, “PC_DIGT” and “PC_ANLG”. PC_DIGT selects the DIGITAL PC COAX IN or DIGITAL PC OPT IN, and PC_ANLG selects the ANALOG PC IN.
Note: The DIGITAL PC OPT IN has priority over the DIGITAL PC COAX IN, so if you connect to both inputs, the signal received at the DIGITAL PC OPT IN is used.

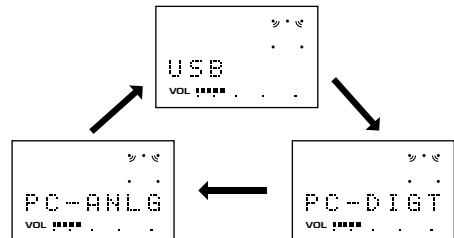

AUX1: Press the **AUX1** key repeatedly to select the inputs: “AUX1_DG” and “AUX1_AN”. AUX1_DG selects the equipment connected to the DIGITAL AUX 1 OPT IN, and AUX1_AN selects the equipment connected to the ANALOG AUX 1 IN connector as the input source.

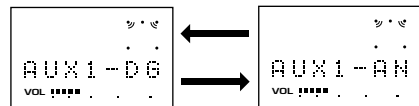

AUX2: Press the **AUX2** key to select the equipment connected to the ANALOG AUX 2 IN connectors as the input source.

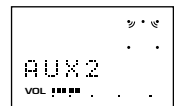

TUNER: Press the **TUNER** key to select the built-in FM tuner as the input source.

* When the **TUNER** key is pressed, “TUNER” appears first on the display, and then changes to the display of a frequency or a preset station.

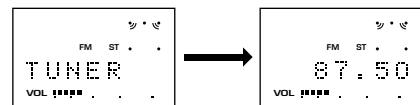

Note

When the **PC**, **AUX1** or **AUX2** input selector key is pressed, the display shows the name of the selected input source for a short while, and then shows the currently selected sound field program.

When no sound field program is selected, "THROUGH" is shown on the display.



The names of input sources shown on the display can be changed with the Application Software. Refer to the Online Help of the Application Software for details.



■ To cut off sound output temporarily

Press the **MUTE** key. To restore sound output, turn the volume control on the front panel or press the **VOLUME** keys on the remote control. Pressing the **MUTE** key again also restores sound output.



Remote control

Note

Sound output will also be restored by changing the status of this unit between standby and power-on modes, changing the input source or the sound field program, using the test tone, or using the **A**, **B**, **C** keys on the remote control.

■ When you listen with headphones

Connect the headphones to the **headphone jack**. No sound will be outputted from the speakers.

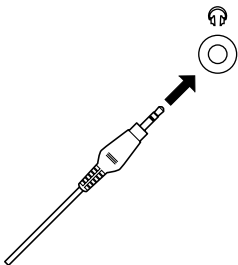

■ When you have finished using this unit

Set this unit to the standby mode by pressing the **power** switch on the front panel or the **POWER** key on the remote control.



Front panel

or

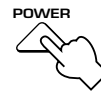

Remote control

Note

When not planning to use this unit for a long period (i.e., vacation, etc.), disconnect the AC power plug from the wall outlet.



■ Setting USB MIX

When an input other than the USB terminal is selected, you can listen to the mixed signals from the selected input and from the USB terminal. Also, the mixing ratio of the signals from the USB terminal can be adjusted.

* Refer to the online help of the Application Software for details.

■ Setting graphic equalizer

You can adjust the frequency characteristics as you prefer by using the 7-band graphic equalizer.

* Refer to the online help of the Application Software for details.



Notes

- Some setting changes may be needed on the computer to reproduce signals sent from the computer to this unit via the USB connection. Refer to the separate "SET UP MANUAL" for details.
- Some setting changes may be needed on the computer to reproduce signals sent from the computer to this unit via a sound card, etc.

Automatic power saving function

If there is no operation on this unit's front panel, the remote control or the Application Software for about 24 hours with the power of this unit on, this unit will automatically be set to the standby mode.

Using sound field programs

This unit's built-in DSP (Digital Sound field Processor) can simulate various acoustic environments, including a concert hall and movie theater, with its seven sound field programs. For the best results, choose a program appropriate for the selected audio source.

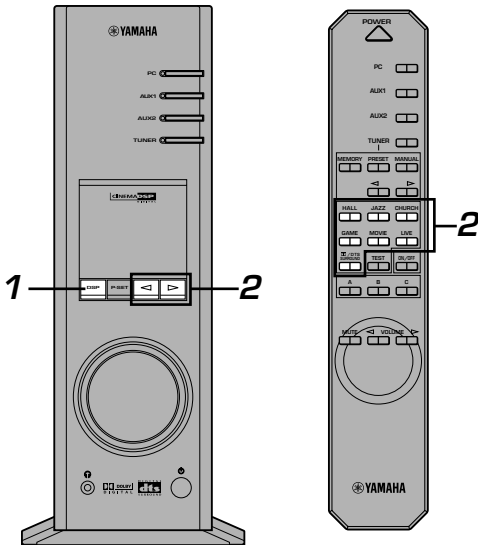

First follow steps 1–5 of “Playing a source” on page 9.

1 Turn on the DSP.



Front panel

(When using the remote control, step 1 can be skipped.)

The name of the selected sound field program appears on the display.

2 Select the desired sound field program.

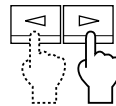

Front panel

or

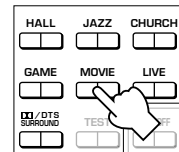

Remote control

Front panel: Pressing ◀ or ▶ repeatedly changes the program.

Remote control: Press the key of the desired program.

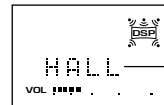

Active program

The following programs are available.

	Program	Feature	Note
HI-FI DSP (for music sources)	HALL (CONCERT HALL EUROPE)	This program simulates the sound field of a medium-sized hall, with a beautiful and rich reverberation.	These programs create a sound field that feels real, just as if you were actually there.
	JAZZ (JAZZ CLUB VILLAGE GATE)	This program simulates the sound field of a famous New York jazz club.	
	CHURCH (CHURCH ROYAUMONT)	This program simulates the sound field of a Gothic church, with the unique effect of sound reverberating back and forth in a domed ceiling.	
CINEMA DSP (for video sources)	GAME (GAME AMUSEMENT)	This program adds depth and surround effects to computer games, enhancing the gaming experience.	These programs can be used together with Dolby Pro Logic, Dolby Digital or DTS for enjoying surround sounds of motion-picture audio. *: HP3D This program enables you to enjoy a virtual 3D effect with headphones. When you connect headphones to this unit, the DOLBY/DTS SUR. program automatically changes to HP3D.
	MOVIE (MOVIE THEATER)	The realism provided by this program gives the impression that you're actually in the scene.	
	LIVE (LIVE CONCERT)	This program produces an enthusiastic atmosphere and lets you feel that you are in the midst of the action, as if attending an actual jazz or rock concert.	
	NORMAL (DOLBY/DTS SUR.) [HP3D* (Headphone 3D)]	This program reproduces the surround sound of a source encoded with Dolby Pro Logic, Dolby Digital or DTS faithfully. Sensing the input signal, the built-in Dolby Digital decoder or the DTS decoder automatically works. When this unit is set to the “Virtual 3D” mode (the surround speakers are not used) in the Application Software, 5.1-channel surround sound effects are reproduced with only two front speakers by using Yamaha’s “Virtual 3D” technology.	

Notes

- Just after selecting a program, the program name scrolls from right to left on the display, and then its short-version name lights up.
- No sound field program can be used when receiving signals with a 96 kHz sampling frequency.



■ Adjusting DSP sound field parameters

The surround effect of each program or the Virtual 3D effect can be adjusted to the desired taste by using the Application Software. Refer to the online help of the Application Software for details.



■ To turn off the sound field effect

Press the **DSP** key on the front panel or the **ON/OFF** key on the remote control. "THROUGH" appears on the display.

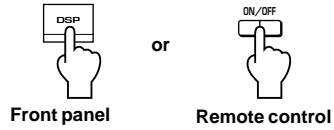

Note

When the sound field effect is off, sound is reproduced in normal stereo.

Recording

Input sources (e.g., a computer or CD player) selected on this unit can be recorded by an MD recorder, tape deck, etc. connected to this unit. Also, input signals can be fed to your computer via the USB connection.

- * When a source is recorded using a sound field program, sound field effects are recorded with the source.

■ Recording on an external recording unit

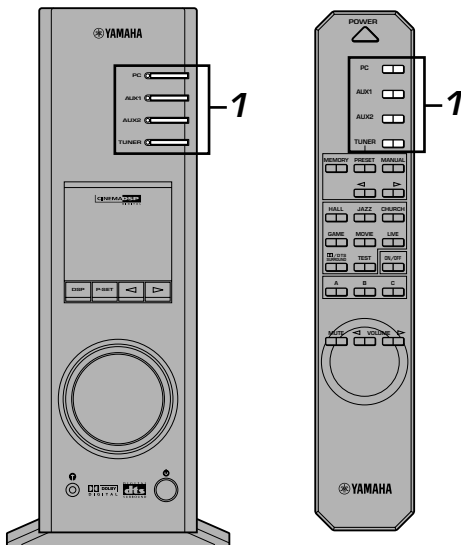

First turn on the external unit to be used, and then this unit.

1 Select the source to be recorded by using the input selector keys.

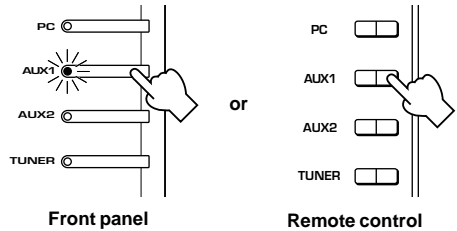

2 Start recording on a recording unit (an MD recorder, tape deck, etc.).

3 Start playing the input source .

■ Playing the recorded result via this unit

Select the input signals sent from the recording unit with the input selector keys.

Notes

- If input signals received at any digital input terminal other than the USB terminal is outputted at the digital output terminal, the sampling frequency for the output signals is the same as that for input signals.
- The sampling frequency for digital signals converted from analog signals on this unit is 44.1 kHz or 48 kHz.
- When digital input signals are outputted at the digital output terminal, track information (CD-text data, automatic track renewal when recording is made on an MD, etc.) is invalid if any sound field program (including the graphic equalizer effect) is used.
- Both REC OUT and OPT OUT terminals on the rear of this unit output the same constituents of signals as outputted from the left and right front speakers.

■ Recording on a computer (via the USB connection)

When recording or processing signals inputted to your computer via the USB connection, the following setting is needed on the computer.

○ Selecting Recording Device

When using Windows

1. Click the Windows "Start" button and select "Settings", and then "Control Panel".
2. Double-click the "Multimedia" icon (or the "Sounds and Multimedia" icon).
3. Click the "Audio" tab and select "USB Audio Device" at "Preferred device" of "Recording" (or "Sound Recording").

When using a Macintosh

Select "USB Audio" as the input device at "Sound" on the Control Panel.

○ Setting of Recording Software

Select a sampling frequency from 44.1 kHz and 48 kHz. Select a resolution from 16 bits and 24 bits. The sampling frequency of 44.1 kHz with the resolution of 16 bits produces a sound quality comparable to the compact disc (CD).

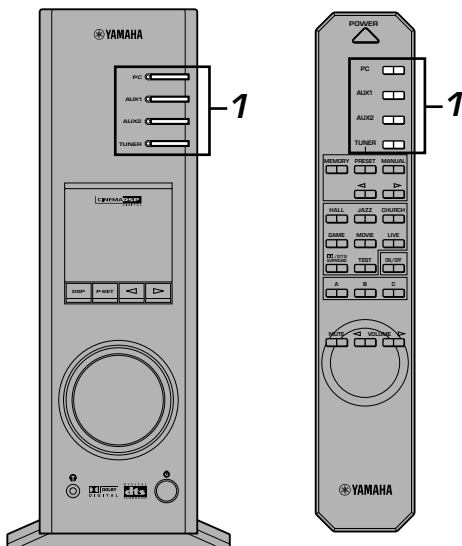

1 Select the source to be recorded by using the input selector keys.

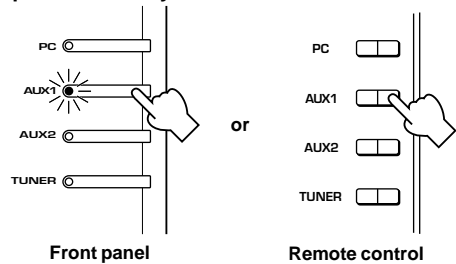

2 Start recording with the recording software on the computer.

3 Start playing the input source.

■ Playing the recorded result via this unit

Press the PC input selector key repeatedly to select USB as the input source, and play the recorded result on the computer.

Notes

- If the number of USB channels is set to six, recording cannot be made via the USB connection. Reset the number of USB channels to two or four.
- To record digital input signals with a 48 kHz sampling frequency, the frequency of the input signals must be 48 kHz.
- To record sound signals received at an analog or digital input of the sound card etc., and not via the USB connection, select the corresponding device, such as "Sound Card", from "Preferred device" of "Recording" (or "Sound Recording") on the computer.
- The sampling frequency and resolution of signals recordable on the computer differ from operating systems. You can refer to the following Yamaha website for details about the related information.

<http://www.yamaha.co.jp/audio/>

Notes

- Please check the copyright laws in your country before recording compact discs, radio, etc. Recording of copyright material may infringe copyright laws.
- You cannot make a recording from a CD-R, MD, etc. which is a copy of an audio CD, to another CD-R, MD, etc. via the USB connection or the digital terminal connection. Also, you cannot make a recording from an MD which is recorded with digital signals received via the USB connection, to another MD via a digital connection.

LISTENING TO AN FM BROADCAST

Tuning into an FM station

Normally, if station signals are strong and there is no interference, quick auto tuning is possible. However, if the signal of the station you want to select is weak or the reception condition is bad, you must tune in to it manually.

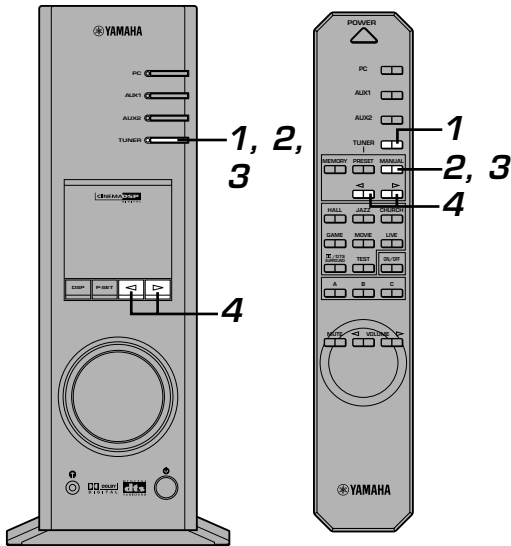

Auto tuning

First turn on this unit.

- 1 Press the TUNER input selector key to select the built-in FM tuner.

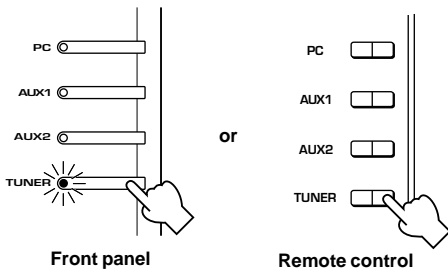

The tuner turns on in either of the following modes. (The mode which was selected the last time you used the tuner is selected.)

- **Frequency display mode**

The display shows the selected frequency. This mode is for tuning into a station by changing the frequency.

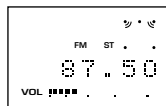

- **Preset tuning mode**

This mode is for tuning into a preset station which is already stored in the memory. The display shows the preset group (A to E), the number (1 to 8) and the frequency of the preset station.

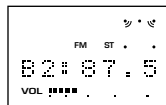

(U.S.A. model)

- 2 If the tuner is in the preset tuning mode, press the TUNER key (front panel) or the MANUAL key (remote control) to change the preset tuning mode to the frequency display mode.

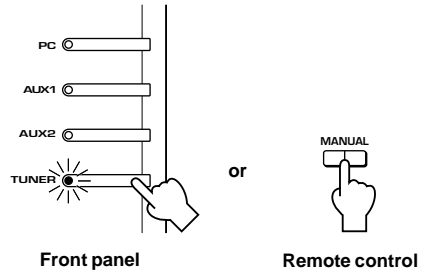

- 3 Press the TUNER key (front panel) or the MANUAL key (remote control) to select the desired reception mode: FM auto stereo or FM monaural.

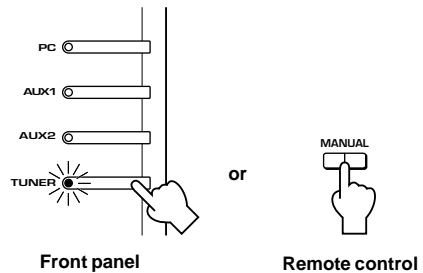

The reception mode changes alternately by each press of the TUNER key.

- **FM auto stereo**

When a stereo broadcast is received, it is received in stereo automatically. (The "ST" indicator lights up on the display.) If, however, the signal of a stereo broadcast is weak, it may be received in monaural automatically. (In this case, the "ST" indicator goes off.)

- **FM monaural**

Any broadcast is received in monaural. (On the display, "M" appears above the frequency.) If you hear noise in the FM auto stereo mode, try switching to FM monaural.

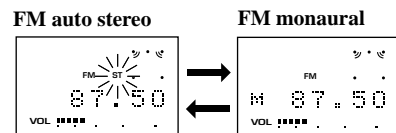

- 4** Press the ◀ or ▶ key and keep it pressed for one second or more.

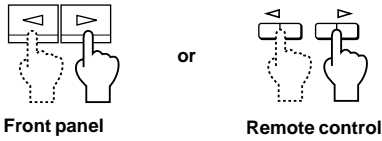

Press the ◀ key to search for lower frequencies and the ▶ key for higher frequencies. When a station with a strong signal is found, the search stops and the station is received. If no station with a strong signal is found, the search stops after searching through all frequencies.

- 5** If the received station is not the desired one, repeat step 4.

Note

If the desired station cannot be found by the auto tuning method, search for the station by using the manual tuning method.

Manual tuning

First turn on this unit.

- 1** Press the TUNER input selector key to select the built-in FM tuner.

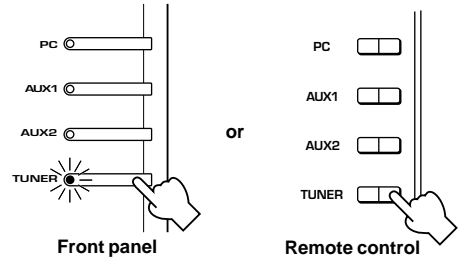

- 2** If the tuner is in the preset tuning mode, press the TUNER key (front panel) or the MANUAL key (remote control) to change the preset tuning mode to the frequency display mode.

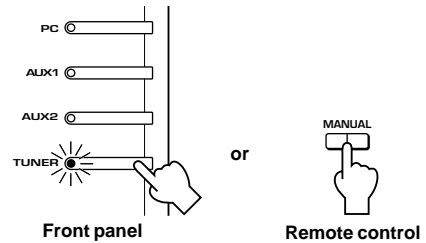

- 3** Press the TUNER key (front panel) or the MANUAL key (remote control) to select the desired reception mode: FM auto stereo or FM monaural.

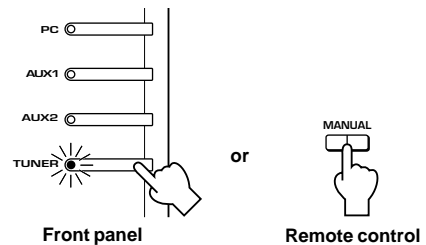

- 4** Press the ◀ or ▶ key repeatedly until the desired frequency is located.

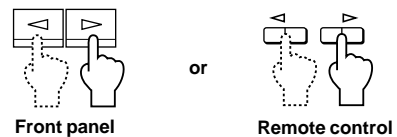

Press the ◀ key to search for lower frequencies and the ▶ key for higher frequencies.

Frequency range and tuning step

	Frequency range	Tuning step
U.S.A. and Canada models	87.50–107.90 MHz	0.20
U.K. and Europe models	87.50–108.00 MHz	0.05
Australia model	87.50–108.00 MHz	0.10

Using the presets

You can store your favorite stations in the 40 presets, which are organized into five groups (A–B), with eight presets in each group. A stored station can be recalled simply by selecting the preset number in which it is stored.

Storing stations manually

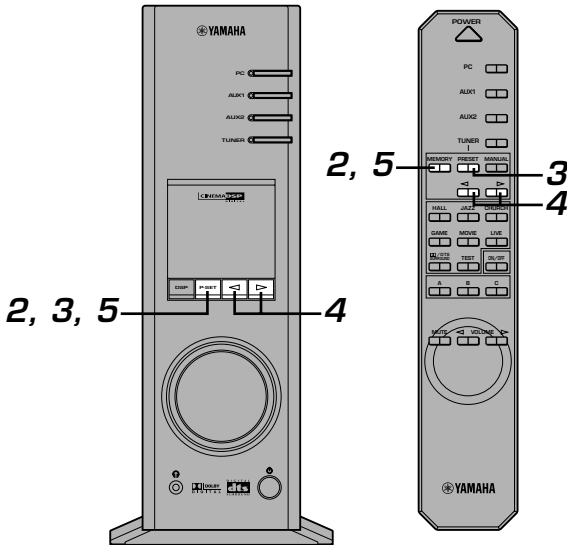

First turn on this unit, and then select the built-in FM tuner as the input source.

- 1** In the frequency display mode, tune into the desired station and select the reception mode: FM auto stereo or FM monaural.

* Refer to pages 14 to 15 on how to tune into a station and select the reception mode.

- 2** Press the P-SET key (front panel) or the MEMORY key (remote control) and keep it pressed for one second or more.

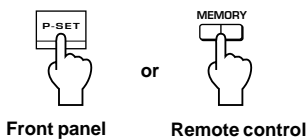

A preset group and a preset number appears and an arrow scrolls from right to left on the display. This means that storing a station is possible.

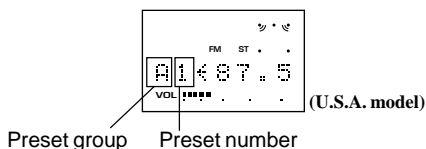

- 3** Press the P-SET key (front panel) or the PRESET key (remote control) repeatedly to select the desired preset group from A through E.

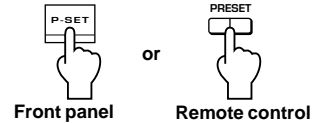

- 4** Press the < key or the > key repeatedly to select the desired preset number from 1 through 8.

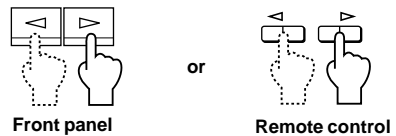

- 5** Press the P-SET key (front panel) or the MEMORY key (remote control) and keep it pressed for one second or more.

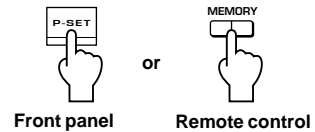

“MEMORY” lights up on the display for approx. 2 seconds to show that the station has been stored.

Notes

- A newly stored station overwrites the previously stored one in the same preset group and number.
- To abort storing the station, press an input selector key (except the TUNER key). The selected input mode appears.

With the supplied Application Software, you can use the auto preset tuning function in addition to the manual method. The auto preset function searches for all stations available in your area and automatically stores them in the presets. Also, the Application Software allows you to assign a name to each preset station. The names are displayed on the monitor when running the Application. Refer to the online help of the Application Software for details.

Recalling a preset station

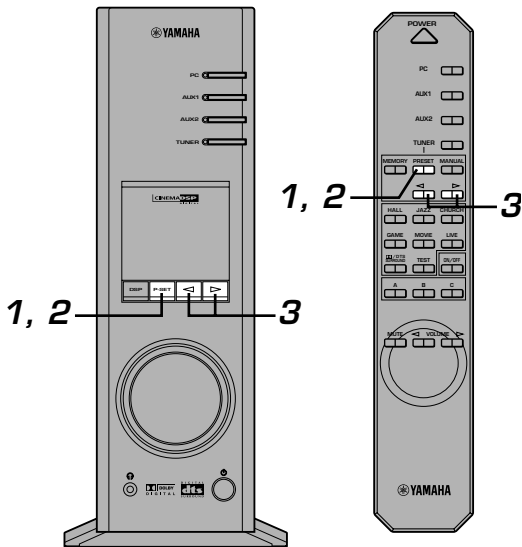

First turn on this unit, and then select the built-in FM tuner as the input source.

- 1** Press the P-SET key (front panel) or the PRESET key (remote control) to change this unit from the frequency display mode to the preset tuning mode.

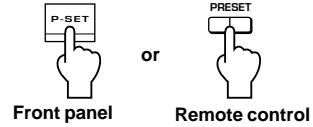

- 2** Press the P-SET key (front panel) or the PRESET key (remote control) repeatedly to select the preset group from A through E.

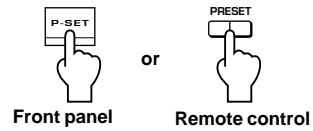

- 3** Press the < key or the > key repeatedly to select the preset number from 1 through 8.

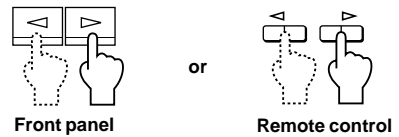

The station stored in the selected preset group and number is selected.

Copying a preset station to a different group and number

You can copy a preset station to a different group and number. Using this function, you can arrange preset stations in your favorite order or collect preset stations into genres.

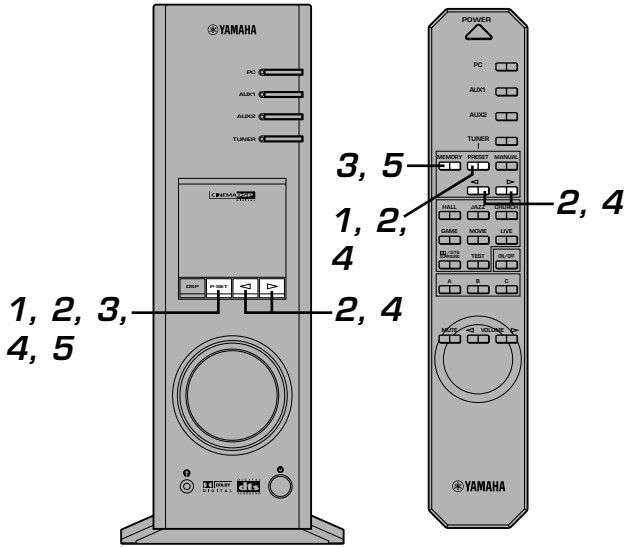

First turn on this unit, and then select the built-in FM tuner as the input source.

- 1** Press the P-SET key (front panel) or the PRESET key (remote control) to change this unit from the frequency display mode to the preset tuning mode.

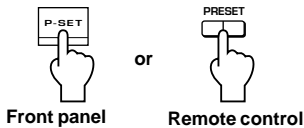

- 2** Use the P-SET (or PRESET) key to select the preset group, and use the </> keys to select the preset number of the station you want to copy.

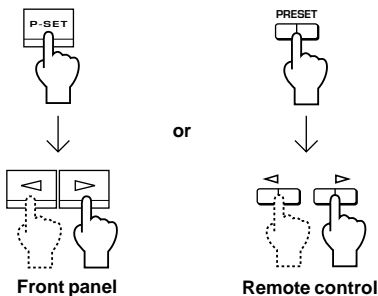

- 3** Press the P-SET key (front panel) or the MEMORY key (remote control) and keep it pressed for one second or more.

An arrow scrolls from right to left on the display.

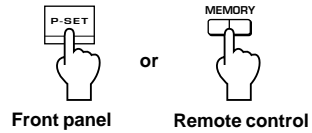

- 4** Use the P-SET (or PRESET) key to select the preset group, and use the </> keys to select the preset number you want to copy the station to.

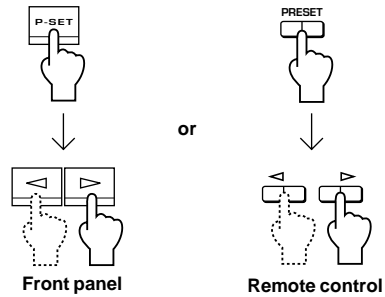

- 5** Press the P-SET key (front panel) or the MEMORY key (remote control) and keep it pressed for one second or more.

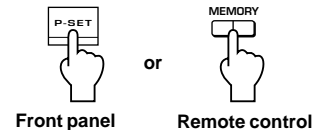

“MEMORY” lights up on the display for approx. 2 seconds to show that the station has been copied and successfully stored.

ADVANCED OPERATION

Adjusting the speaker balance

This procedure lets you adjust the sound output level balance between the front, center and surround speakers by using the built-in test tone generator. Make this adjustment so that each speaker output level is about the same when heard at the listening position. This is important for high performance of the built-in DSP (Digital Sound field Processor), the Dolby Digital decoder and the DTS decoder.

If this unit is set to the "Virtual 3D" mode (the surround speakers are not used) in the Application Software, you can adjust the sound output levels of the speakers in the sound field of the "Virtual 3D" mode (including two virtual surround speakers). Refer to "Setting adjustment on the Setup panel" on page 27. This setting cannot be made by using the front panel controls or the remote control.)

* Use the remote control for adjusting the speaker output levels at the listening position.

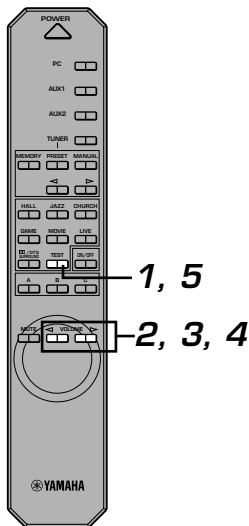

1 Press the TEST key on the remote control.



* You will hear a test tone (so called pink noise) from each speaker for about two seconds in the following order.

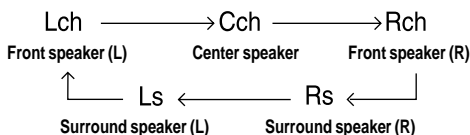

* The speaker currently outputting the test tone is shown on the display.

2 When the test tone is outputted from the left (L ch) or right (R ch) front speaker:

Use the VOLUME keys on the remote control to adjust the volume of each speaker.

In this step, adjust the volume balance between the left and right front speakers.

(Adjustable range: -10 to 0)

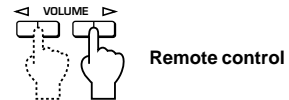

3 When the test tone is outputted from the center speaker (Cch):

Use the VOLUME keys on the remote control to adjust the center speaker output level.

Make the sound output level of the center speaker about the same as the left or right front speaker.

(Adjustable range: -20 to +10)

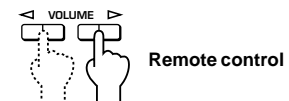

4 When the test tone is outputted from the left (Ls ch) or right (Rs ch) surround speaker:

Use the VOLUME keys on the remote control to adjust the volume of each speaker.

Make the sound output level of the surround speakers about the same as the front speakers.

(Adjustable range: -20 to +10)

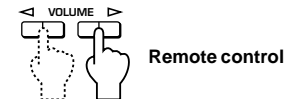

5 When the adjustments are finished, press the TEST key.



The test tone stops.

Notes

- **When this unit is set to the “Virtual 3D” mode:**
The output order of the test tone is as follows.

When using a center speaker:

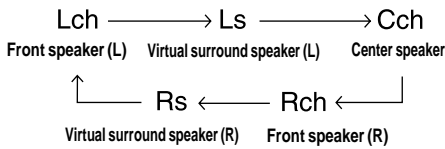

When not using a center speaker:

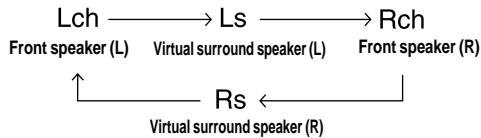

- **Adjust the subwoofer level while listening to a suitable source.**



With the supplied Application Software, you can select the speakers to use and not to use. Also, by designating the size of the speakers to use, this unit can be set to an output mode suitable for the ability of the speakers.



Setting USB channel

Typical USB audio features multi-channel modes, such as four-channel and six-channel modes, in addition to a normal two-channel (stereo) mode. This unit is compatible with each of these modes. When a multi-channel mode is selected, you can receive the surround sound signals of computer games compatible with the 4ch Direct Sound 3D and the multichannel signals of DVD video on this unit via the USB connection and enjoy them in surround sounds. Note that some operating systems and software programs are not multi-channel compatible. Yamaha websites list the names of multi-channel compatible operating systems and software.

Notes

- MacOS9.04, 9.1, etc. does not support this feature. Only the two-channel mode can be used. Some versions of Windows also do not support the six and/or four-channel modes. You can refer to the following Yamaha website for details and related information.
<http://www.yamaha.co.jp/audio/>
- When the six channel mode is selected, recording cannot be made to the computer. To record, select the two- or four-channel mode.

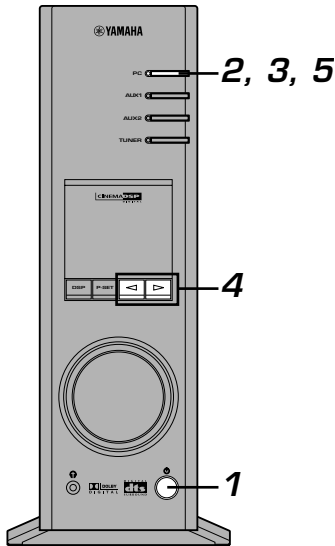

How to set

* When playback or recording is performed on the computer via the USB connection, terminate the playback or recording software used on the computer.

1 Turn on this unit.



2 Press the PC input selector key repeatedly until "USB" appears on the display.

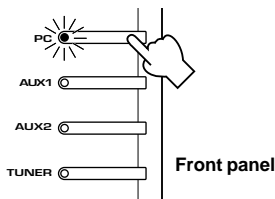

3 Hold down the PC input selector key until the current channel setting is shown (for about two seconds).

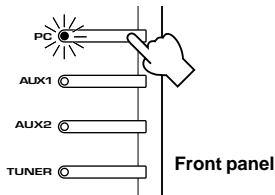

* When the display of this unit shows "USB" in red, USB audio is being played back, disabling this USB channel setting function. Terminate the software used on the computer.

4 Press < or > repeatedly until the desired number of channels is shown on the display.

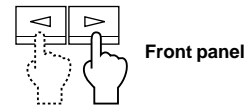

The display changes as follows.

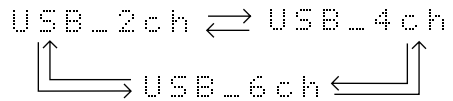

5 Hold down the PC input selector key until the following indication appears on the display.

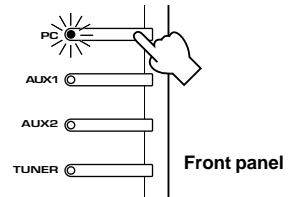

The number of channels before the change

The number of channels after the change

Although no further operation is required, wait a short time until the computer completes the changes in the settings.

Notes

- When the number of channels is changed for the first time, the device driver for the USB audio is installed in the computer. Wait a short time until the computer completes the changes in the setting.
- Do not change the USB channel setting under any circumstance during playback or recording via the USB connection on the computer. If changed, the computer may freeze.

Operating this unit with the Application Software

If this unit is connected to your computer via the USB connection and the Application Software is installed in your computer from the supplied CD-ROM, you can operate this unit with the Application Software from your computer. Moreover, the Application Software, once installed on your computer, offers various settings unavailable from this unit or the remote control. (For instructions on how to install the Application Software, see the separate “**SET UP MANUAL**”.)

About the Main Panel

The Main Panel allows you to perform the following basic operations.

Tabs are shown at the bottom of the detailed-setting screen. To make detailed settings of the desired function available from any detailed-setting screen, click on the tab for the function.

This section briefly explains how to use the Application Software, the setting screens, and the available functions. For further details, refer to the Online Help of the Application Software.

Notes

- The screen images shown in this section are of the basic screens for the Windows version. The Macintosh version slightly differs in button arrangement, etc.
- The screen design, functions, etc., are subject to change due to version upgrades.

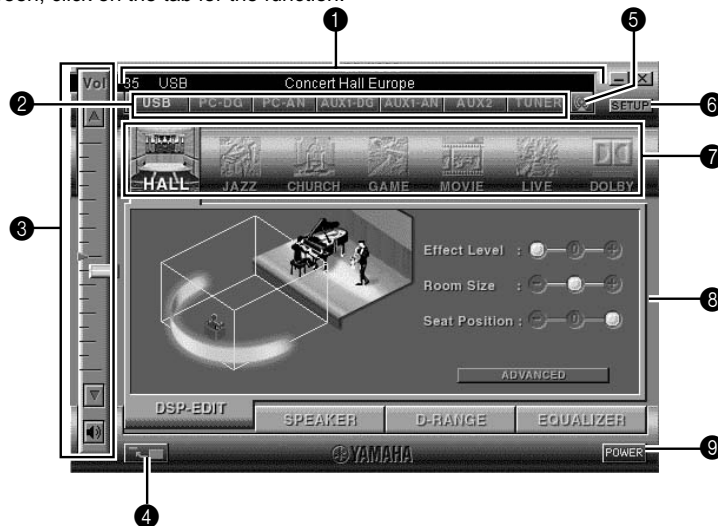

1 Display

This section shows the current status of the volume, input selectors, sound field programs, etc. by characters.

2 Input selector

The input selector allows you to directly change the input source.

3 Volume control

You can adjust the volume by dragging the indicator or by clicking the up (▲) and down (▼) arrows. You can also alternately turn on and off the speakers by clicking the speaker icon below.

4 Changing the panel size

You can minimize the size of the Main Panel.

5 Opening the tuner panel

Press this button to open the tuner panel. (See page 26 for details on operating the FM tuner.)

6 SETUP

Open this panel to change available settings in the Setup panel. (See page 27 for details on the Setup panel.)

7 DSP selector

You can directly select a DSP sound field program.

8 Detailed-setting screens

Select one of the detailed-setting screen tabs at the bottom of the current detailed-setting screen. The new detailed-setting screen will be displayed, where you can make detailed settings of the function.

DSP-EDIT: For adjusting the DSP sound field parameters (See page 23.)

SPEAKER: For adjusting the speaker output levels or the virtual 3D effect (See page 24.)

D-RANGE: For adjusting the dynamic range (See page 25.)

EQUALIZER: For operating the graphic equalizer (See page 25.)

9 POWER

Each click changes the status of the main unit between standby and power-on.

Adjusting DSP sound field parameters

You can adjust various parameters of the DSP sound field programs.

The default parameters of the sound field programs provide great sound, but it is also possible to fine-tune the parameters to suit the acoustics of the room, individual preferences, and program source. Parameter adjustment is required for each selected sound field program.

How to adjust parameters

1. Select the program whose parameters you wish to adjust. (Parameter adjustment is effective for the currently selected program only.)
2. Select the **DSP-EDIT** tab at the bottom of the Main Panel. The basic parameter screen appears.
3. This screen allows you to adjust the basic parameters. Open the "ADVANCED SETTING" panel for adjusting the detailed parameters.

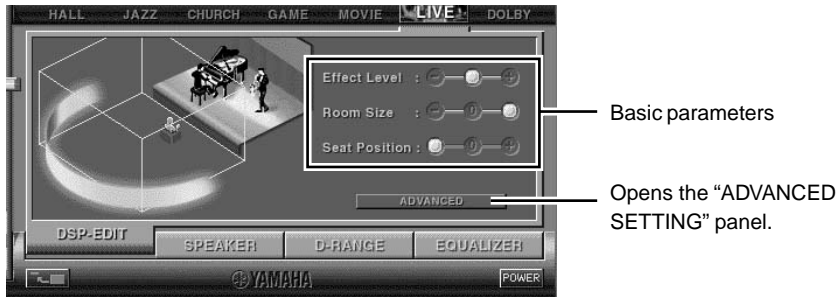

Basic parameters

Effect Level	Selects the level of effect sound from the three levels.
Room Size	Selects the apparent size of the listening space from the three levels.
Seat Position	Selects the simulated listening position from the three positions.

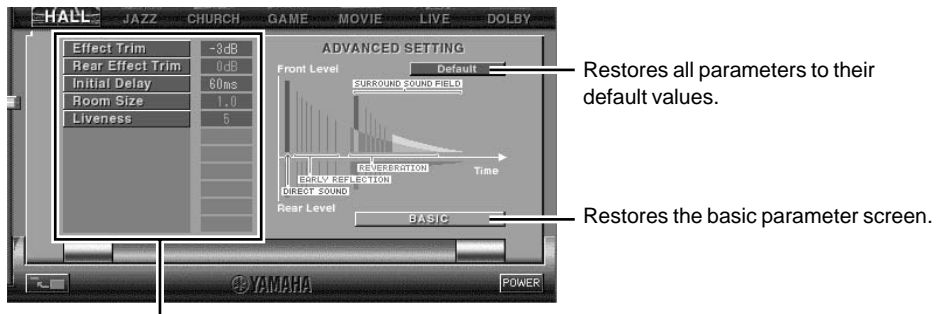

Select a parameter by clicking its name, and adjust the parameter by sliding the indicator at the bottom of the panel.

Detailed parameters

The following parameters are available on the "ADVANCED SETTING" panel. Depending on the selected program and input signals, not all of the parameters can be adjusted.

Effect Trim	Makes fine adjustment of the level of the overall effect sound.
Rear Effect Trim	Makes fine adjustment of the level of the rear effect sound.
Initial Delay	Adjusts the apparent distance from the sound source to the walls.
Room Size	Adjusts the apparent size of the listening space.
Liveness	Adjusts the apparent reflectivity of the walls.
Surround Delay	Adjusts the delay time of the surround sound field.
S. Initial Delay (Surround Initial Delay)	Adjusts the initial delay time of the surround sound field. (This parameter can be adjusted only when the "Speaker Settings" of this unit has been set to two front and two surround channels or more, and Dolby Digital- or DTS-encoded signals are inputted.)
S. Room Size (Surround Room Size)	Adjusts the apparent size of the surround sound field.
Reverb Time	Adjusts the duration of reverberations.
Reverb Level	Adjusts the level of reverberations.
Reverb Delay	Adjusts the delay time of reverberations.

Adjusting the speaker output levels and effect levels

When the check box “Use the surround speakers” under “Speaker Settings” in the Setup panel is checked, you can adjust the output levels of the available speakers respectively. When the check box is not checked, this unit is in the virtual 3D mode, allowing adjustment of the virtual 3D effects. (See page 27.)

Select the **SPEAKER** tab at the bottom of the Main Panel. The following screen appears.

Adjusting the output levels of the speakers

You can adjust the output levels of the speakers which are set for use under “Speaker Settings” in the Setup panel.

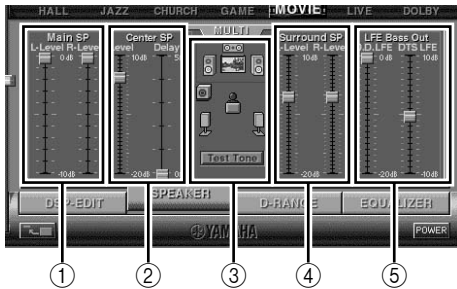

- ① **Adjusting the output levels of the main speakers**
You can adjust the output levels of the left and right main speakers.
- ② **Adjusting the output level and the delay time of the center speaker**
You can adjust the output level and the delay time of the center speaker.
- ③ **Test tone**
Click on “Test tone” to output the test tone from the respective speakers in turn. You can adjust their levels while listening to the test tone. On the figure of the speakers at the center of the screen, the speaker currently outputting the test tone is indicated.
- ④ **Adjusting the output levels of the surround speakers**
You can adjust the output levels of the left and right surround speakers.
- ⑤ **Adjusting the LFE output levels**
You can adjust the output level of the LFE (Low Frequency Effect) sounds reproduced when playing a Dolby Digital- or DTS-encoded source. The levels can be adjusted for Dolby Digital and DTS respectively.

Adjusting the virtual 3D effect

The surround sound effect of the virtual 3D sound field is affected by the room configuration, the position of the front speakers and the position of the listener, resulting in sound unique to each environment. The procedure below shows you how to adjust the effect of the virtual 3D to suit your preferences and environment.

Select the **VIRTUAL** tab at the bottom of the Main Panel. The following screen appears.

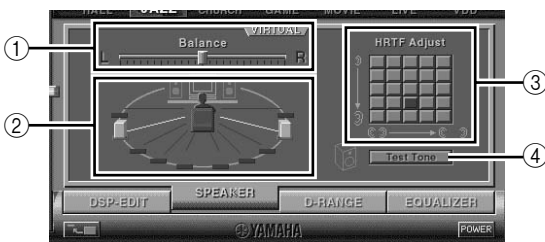

- ① **Balance adjustment**
You can adjust the volume balance between the right and left speakers.
- ② **Virtual surround speaker position setting**
You can set the position of the virtual surround speakers (the speakers are positioned symmetrically.)
- ③ **HRTF (Head-related Transfer Function) adjustment**
You can make an adjustment to personal characteristics.
- ④ **Test tone**
You can output a test tone successively from the speakers at their current positions, allowing setting and adjustment while listening to the tone.

Adjusting the dynamic range

You can set the dynamic range for playing a source with Dolby Digital decoded. This is especially effective for low-volume listening. Select the **D-RANGE** tab at the bottom of the Main Panel. The following screen appears.

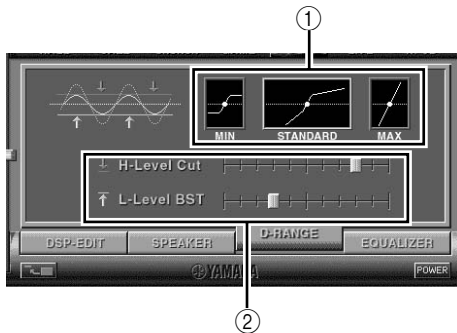

① Dynamic range setting

Select the dynamic range for playing a source with Dolby Digital decoded from MIN, STANDARD, and MAX. The MAX setting provides a dynamic range of a movie theater while MIN provides a dynamic range suitable for late night, low-volume listening.

② Dynamic range adjustment

This setting becomes available when you choose STANDARD for the dynamic range. This adjusts high-level cut scale (H-LEVELCut) and low-level boost scale (L-LEVELBST), allowing you to freely adjust the dynamic range between MAX and MIN.

Operating the graphic equalizer

The 7-band graphic equalizer allows you to set the frequency characteristics according to the type of the music that is played and to compensate for the room characteristics and the speakers' frequency characteristics. The graphic equalizer effect is only applied to the left and right front channels.

This panel is always shown when no DSP sound field program is selected. When a DSP sound field program is selected, selecting the **EQUALIZER** tab at the bottom of the Main Panel will show this panel.

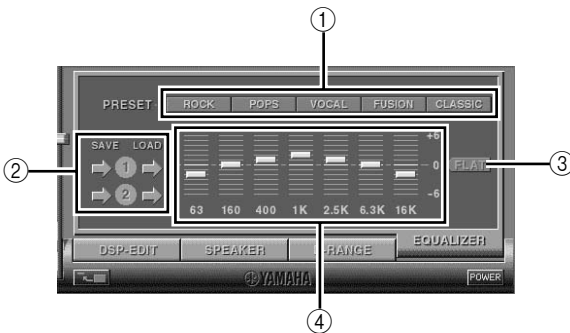

① Preset patterns

Five patterns of frequency characteristics have been preset for different types of music, such as "ROCK" and "POPS". Click a button to select the effect that suits the music type.

② Storing and calling user's patterns

You can store and call up to two patterns of frequency characteristics you specify.

③ FLAT

This makes the frequency response curves flat.

④ Graphic equalizer

The 7-band equalizer allows you to set your desired frequency response curves. By dragging the indicator for each frequency band, you can adjust the frequencies within the range of +6 to -6 dB.

Operating the built-in FM tuner

With the Application Software, you can operate the tuner more easily than on the front panel or the remote control, including additional functions available only in the Application Software for example storing stations automatically and assigning names to preset stations.

Click the button for calling the tuner panel at the right upper part of the Main Panel. The following screen appears.

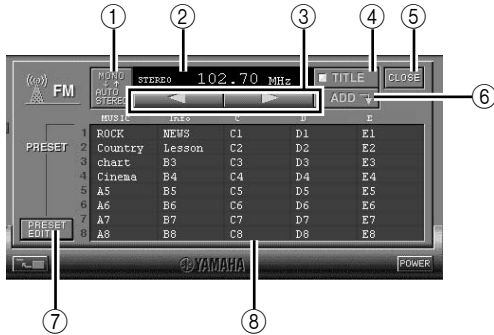

- Switching the reception mode**
This button toggles the reception mode between FM auto stereo and FM monaural.
- Station display**
The frequency of the currently received station or the name of the preset station is shown here.
- Manual tuning </> (down/up) buttons**
Press > to select higher frequencies and < to select lower frequencies.
- TITLE**
This button toggles the display mode of the preset station list between frequencies and names.
- CLOSE**
This button closes the tuner panel.
- ADD**
This button is used for adding or changing preset stations.
- PRESET EDIT**
This button opens the “Tuner Preset Edit” panel.
- Preset station list**
This list shows all the preset stations by their frequencies or names.

Storing stations (Tuner Preset Edit)

Click the PRESET EDIT button in the left lower part of the tuner panel. The following screen opens and allows you to edit the presets.

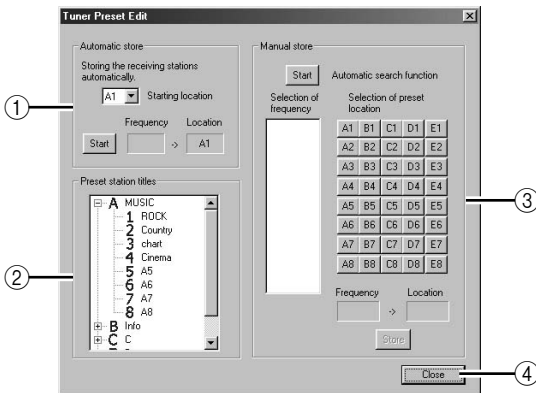

- “Automatic store”**
Click the “Start” button, and receivable stations are stored in sequence automatically.
- “Preset station titles”**
You can assign a name consisting of up to eight characters to each preset station. The names are shown in the preset station list in the tuner panel.
- “Manual store”**
You can store the desired stations one by one. Click the “Start” button, and all of the receivable stations are searched. You can select only the desired stations and store them onto the desired preset groups and numbers.
- “Close”**
Click this button to close the current “Tuner Preset Edit” panel and return to the tuner panel.

Setting adjustment on the Setup panel

When you click SETUP of the Main Panel, the Setup panel appears, allowing you to perform the following settings.

Edit Names of Input Sources

You can assign a name consisting up to seven characters to each input source. For example, if a tape deck is connected to the AUX 1 terminals, you can change the name, AUX 1, to TAPE. As this name change information is sent to the main unit, the display on the main unit changes simultaneously.

Volume Settings

■ USB Mix

When USB Mix is on, even if signals received at input terminal(s) other than the USB terminal when it is selected, you can mix the input signals from that selection with the signals from the computer via the USB connection and play the mixed signals. For example, while you are listening to music from the tape deck connected to AUX 1, mail arrival beeps and warning beeps are also available.

Clicking the check box to enter the check mark in the box will turn on the USB Mix. This status allows you to adjust the volume level of the signals from the USB connection. (As this adjusts the volume balance between the selected input signals and the input signals from the USB connection, it does not affect the volume when USB is selected by the input selector keys.)

Clicking the check box to delete the check mark will turn off the USB Mix. In this status, the signals from the USB connection can be played only when USB is selected by the input selector keys.

Note

The sound field programs have no effect on USB-mixed signals. (Sound is in normal stereo.)

■ Maximum Volume Setting

When adjusting the volume in the Application Software, you may inadvertently turn up the volume too high. To avoid this, you can use this function to set a maximum volume for the Application Software.

■ Digital Volume Setting

This allows you to digitally turn up and down the volume in the DSP. Take care not to turn up the volume when the level of the digital input signal is high as it may cause sound distortion due to digital processing. If sound distortion occurs, turn down the volume.

Note

It may happen that the volume is fixed to "0" when digital signals are inputted and the sound field effect is off (THROUGH).

USB Multi-Channel Setting (for Windows only)

This allows you to select the number of channels for sending playback signals via the USB connection from two, four, and six channels. (Note that you cannot record signals from the USB connection on the computer when six channels are selected.)

Skin Selection

This allows you to select the skin (the design of the background picture of the Application Software) from several preset patterns.

Note

This feature is not available when using a Macintosh computer.

Speaker Settings

This allows you to select the speakers (center, surround and subwoofer) to use or not to use. Also, you can select the size (small or large) of the speakers to use. Make this setting correctly to maximize the performance of your speaker system.

Setting Remote Control Custom keys

This allows you to store a set of commands (input selector, sound field program, volume setting, etc.) to each of the **A**, **B** and **C** keys on the remote control. After storing, simply pressing each key will execute the stored command.

About This Application

This gives you information about the version of this Application Software.

Note

The screen design, functions, etc. are subject to change due to software upgrades. For details, refer to the Online Help of the Application Software.

APPENDIX

Troubleshooting

Refer to the chart below if this unit does not function properly. If the problem you are experiencing is not listed below or if the instructions given below do not help, disconnect the power cord and contact your authorized YAMAHA dealer or service center.

Problem	Cause	Remedy	
The unit cannot be turned on though the power switch is pressed.	The power cord is not plugged in or is not completely inserted.	Firmly plug in the power cord.	
No sound.	This unit is in the standby mode.	Turn on this unit by pressing the power switch on the front panel or the POWER key on the remote control.	
	Incorrect output cord connections.	Connect the cords properly. If the problem persists, the cords may be defective.	
	The muting function of this unit is on.	Turn off the muting by pressing the MUTE key.	
	Headphones are connected to the headphone jack of this unit.	Disconnect the headphones from the headphone jack to output sound from the speakers.	
	The volume is set to minimum.	Increase the volume.	
	The playback source is not selected by the input selector keys.	Select the playback source using the input selector keys.	
		When PC is selected as the input source, check that the USB, digital or analog input is correctly selected.	
The power of the equipment selected as the input source is off.	Turn on the equipment.		
No sound from the surround speakers	The output level of the surround speakers is set to minimum.	Increase the output level of the surround speakers by using the test tone. (Refer to page 19 on how to adjust the speaker output levels.)	
	The DSP is off.	Turn on the DSP and select an appropriate sound field program.	
	Under "Speaker Settings" in the SETUP panel of the Application, the check box "Use the surround speakers" is not checked.	Check the check box "Use the surround speakers".	
No sound from the center speaker	The output level of the center speaker is set to minimum.	Increase the output level of the center speaker by using the test tone. (Refer to page 19 on how to adjust the speaker output level.)	
	The DSP is off, or a Hi-Fi DSP program is selected.	Turn on the DSP and select a CINEMA DSP program.	
	Under "Speaker Settings" in the SETUP panel of the Application, the check box "Use the center speaker" is not checked.	Check the check box "Use the center speaker".	
	The source does not contain center channel sound signals.	Use a source which contains center channesound signals.	
No sound field effect.	The DSP is off.	Turn on the DSP.	
No effect of Dolby Digital or DTS though the sound field program "NORMAL" is selected.	The playback source is encoded with neither Dolby Digital nor DTS.	Use a source encoded with Dolby Digital or DTS.	

Problem	Cause	What to Do
When making a recording from an audio CD to an MD, CD-R, etc., all tracks are recorded as one track.	A DSP sound field program is selected or the built-in graphic equalizer is used.	Turn off the DSP and the graphic equalizer.
Program sources on an MD, CD-R, etc. which is a copy of an audio CD, cannot be recorded on the computer via the USB connection.	You cannot make a recording from a CD-R, MD, etc. which is a copy of an audio CD, to another CD-R, MD, etc. via the USB connection or the digital terminal connection.	Record the signals of such an MD, CD-R, etc. on the computer by sending the signals via an analog connection.
Signals inputted to your computer via the USB connection cannot be recorded on the computer.	Incorrect setting of the recording device on the computer.	Correctly set the recording device on the computer. [Refer to "Recording on computer (via the USB connection)" on page 13.]
Different sounds are heard together.	Sound from the computer via the USB connection may be mixed with sound from other sources because the "USB Mix" setting is set to "ON" with the Application Software.	Set the "USB Mix" setting to "OFF" if you do not want to hear mixed sounds.
Using this unit affects TV reception or the performance of other equipment.	The equipment may be too close to this unit.	Move the equipment away from this unit.
Left and right volume levels are different.	The level balance is not set to center on the "Balance" setting on the VIRTUAL panel in the Application Software.	Set the level balance to center.
The remote control does not work.	The batteries of the remote control are weak.	Replace the batteries with new ones.
The remote control does not function properly.	Wrong distance or angle.	The remote control will function from a maximum range of 6 meters and no more than 30 degrees off-axis from the front panel.
	Direct sunlight or strong light (of an inverter type fluorescent lamp etc.) is striking the remote control sensor of the main unit.	Reposition the main unit.

When installing or using the Application Software

Problem	Cause	What to Do
Application does not start.	This unit and the computer is not connected with the USB cable.	Connect this unit and the computer with the USB cable.
	The power cord is not plugged in or is not completely inserted.	Firmly plug in the power cord.
The driver software cannot be installed successfully.	The USB cable is not firmly connected between this unit and the computer.	Disconnect the USB cable, and then connect it firmly again.
	The power cord is not plugged in or is not completely inserted.	Firmly plug in the power cord.

When using the built-in FM tuner

Problem	Cause	What to Do
Crackling noise from time to time.	Interference from the starting motor of a nearby car.	Position the FM antenna as high and as far away from nearby roads as possible.
		Use a coaxial cable for connecting the antenna.
	Interference from the thermostats of a nearby electric appliance.	Install a noise canceller on such an appliance.
Noise increases when receiving a stereo broadcast, or the reception mode changes from stereo to monaural unexpectedly.	Because of the characteristics of FM broadcasts, this is limited to cases where the transmitter is far away or the antenna signal is weak.	Check the antenna connections.
A desired station cannot be received by the auto tuning method.	Because of the characteristics of FM broadcasts, this is limited to cases where the transmitter is far away or the antenna signal is weak.	Install a multi-element type FM antenna if possible.
		Tune in to the station manually.
Stereo broadcasts are noisy and the ST indicator flashes.	Weak antenna signal.	Install an antenna suitable for the electric field strength of your area.
	Not tuned correctly.	Retune.
There is distortion or clear reception cannot be obtained even when using a good quality FM antenna.	There is multipath interference.	Change the position of the antenna.
Preset stations cannot be selected.	The preset memory has been erased.	Store the stations again.

Depending on some computer hardware or operating systems, all functions of this unit cannot be used. You can refer to the following Yamaha website for details and related information.
<http://www.yamaha.co.jp/audio/>

Memory back-up
 The memory back-up circuit prevents the setting of the input selector, the sound field program, the preset memory of the tuner from being lost even if the AC power cord is disconnected from the AC outlet or the power is cut due to a temporary power failure. If, however, the power is cut for more than one week, the memory may be erased. In that case, you must make the necessary settings, and store the FM stations in memory again.

Specifications

Minimum RMS Output Power per Channel 12W × 5 (20 Hz–20 kHz, 4Ω, 1% THD)	Residual Noise (IHF-A Network) –66 dB or less (SP Output, L/R)
Maximum Power 14W × 5 (1 kHz, 4Ω, 10% THD)	Tuning Range [U.S.A. and Canada models] 87.5 to 107.9 MHz [Europe, U.K. and Australia models] 87.5 to 108.0 MHz
Input Sensitivity/Input Impedance PC IN, AUX1 IN, AUX2 IN (ANALOG) 150 mV/35 kΩ	Usable Sensitivity MONO 6 dBμ
Maximum Input Signal PC, AUX1, AUX2 2.1V or more (1 kHz)	Power Supply [U.S.A. and Canada models] AC 120V, 60 Hz [Europe and U.K. models] AC 230V, 50 Hz [Australia model] AC 240V, 50 Hz
Output Level/Output Impedance REC OUT 150 mV/2.0 kΩ SUBWOOFER OUTPUT 1.0V/1.7 kΩ (50 Hz)	Power Consumption 90W (In the standby mode: 5W or less)
Headphone Jack Output Level/Output Impedance ANALOG PC IN, etc. 320 mV/61Ω (1 kHz, 150 mV)	Dimensions (W × H × D) 120 × 294 × 355 mm (4-3/4" × 11-9/16" × 14")
Frequency Response USB, DIGITAL IN (PC, AUX1) to SP Output 20 Hz–20 kHz (±2.0 dB)	Weight 5.5 kg (12 lbs. 2 oz.)
Total Harmonic Distortion (1 kHz, 20 kLPF) USB, DIGITAL IN (PC, AUX1) to SP Output 0.2% or less (5V/4Ω)	Accessories CD-ROM (Windows/Macintosh-hybrid) USB cable Remote control Battery × 2 Indoor FM antenna
Signal-to-Noise Ratio USB to SP Output 85 dB or more PC IN, AUX1 IN (DIGITAL) to SP Output 85 dB or more	

Specifications are subject to change without notice.



YAMAHA ELECTRONICS CORPORATION, USA 6660 ORANGETHORPE AVE., BUENA PARK, CALIF. 90620, U.S.A.
YAMAHA CANADA MUSIC LTD. 135 MILNER AVE., SCARBOROUGH, ONTARIO M1S 3R1, CANADA
YAMAHA ELECTRONIK EUROPA G.m.b.H. SIEMENSSTR. 22-34, 25462 RELINGEN, BEI HAMBURG, F.R. OF GERMANY
YAMAHA ELECTRONIQUE FRANCE S.A. RUE AMBROISE CROIZAT BP70 CROISSY-BEAUBOURG 77312 MARNE-LA-VALLÉE CEDEX02, FRANCE
YAMAHA ELECTRONICS (UK) LTD. YAMAHA HOUSE, 200 RICKMANSWORTH ROAD WATFORD, HERTS WD1 7JS, ENGLAND
YAMAHA SCANDINAVIA A.B. J A WETTERGRENS GATA 1, BOX 30053, 400 43 VASTRA FRÖLUNDA, SWEDEN
YAMAHA MUSIC AUSTRALIA PTY, LTD. 17-33 MARKET ST., SOUTH MELBOURNE, 3205 VIC., AUSTRALIA

YAMAHA CORPORATION
Printed in Malaysia  V688980