

DTX drums

DRUM TRIGGER MODULE

DTX700

Owner's Manual
(Setup / Basic Operation)



Read on paper
(see page 6 for Table of Contents)

Read first

Owner's Manual (Setup / Basic Operation) :
This booklet

**Read when
necessary**

Data List : Separate booklet



Read on your computer
(PDF file)

**Read when
necessary**

Reference Manual (Detailed Operation)

Please download from this web page:
<http://www.yamaha.co.jp/manual/>

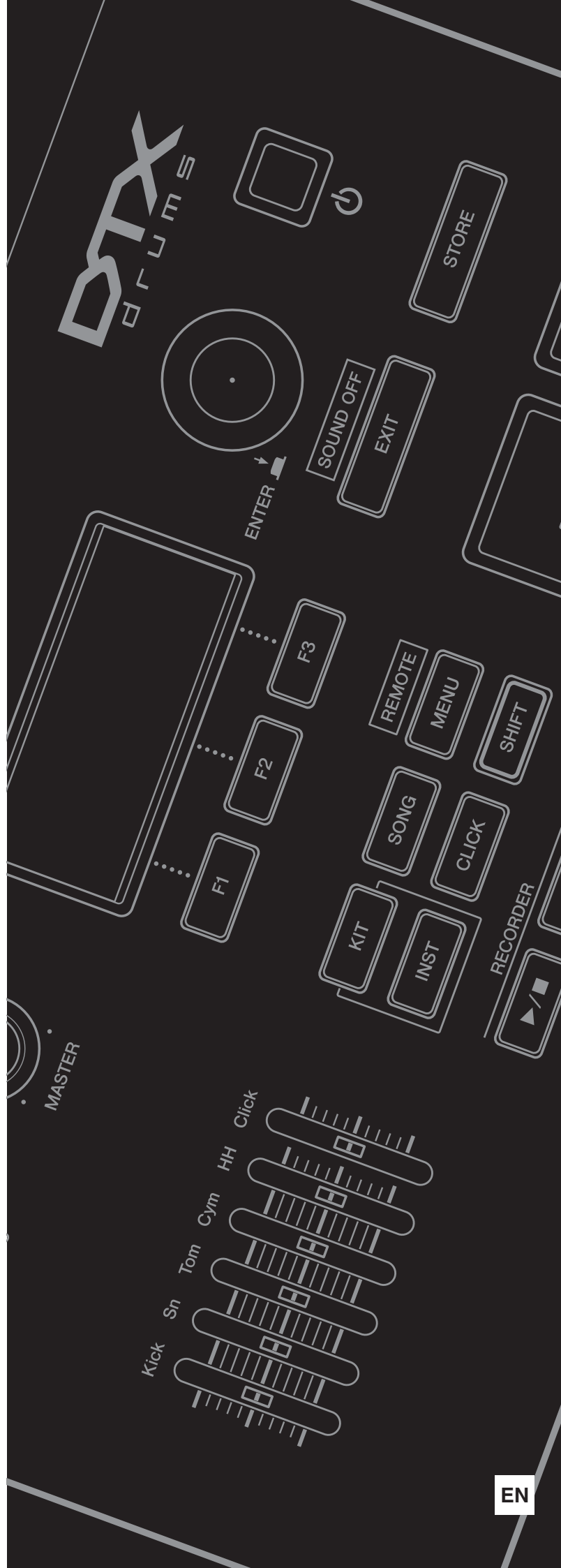

SPECIAL MESSAGE SECTION

This product utilizes batteries or an external power supply (adapter). DO NOT connect this product to any power supply or adapter other than one described in the manual, on the name plate, or specifically recommended by Yamaha.

This product should be used only with the components supplied or; a cart, rack, or stand that is recommended by Yamaha. If a cart, etc., is used, please observe all safety markings and instructions that accompany the accessory product.

SPECIFICATIONS SUBJECT TO CHANGE:

The information contained in this manual is believed to be correct at the time of printing. However, Yamaha reserves the right to change or modify any of the specifications without notice or obligation to update existing units.

This product, either alone or in combination with an amplifier and headphones or speaker/s, may be capable of producing sound levels that could cause permanent hearing loss. DO NOT operate for long periods of time at a high volume level or at a level that is uncomfortable. If you experience any hearing loss or ringing in the ears, you should consult an audiologist.

IMPORTANT: The louder the sound, the shorter the time period before damage occurs.

NOTICE:

Service charges incurred due to a lack of knowledge relating to how a function or effect works (when the unit is operating as designed) are not covered by the manufacturer's warranty, and are therefore the owners responsibility. Please study this manual carefully and consult your dealer before requesting service.

ENVIRONMENTAL ISSUES:

Yamaha strives to produce products that are both user safe and environmentally friendly. We sincerely believe that our products and the production methods used to produce them, meet these goals. In keeping with both the letter and the spirit of the law, we want you to be aware of the following:

Battery Notice:

This product MAY contain a small non-rechargeable battery which (if applicable) is soldered in place. The average life span of this type of battery is approximately five years. When replacement becomes necessary, contact a qualified service representative to perform the replacement.

This product may also use "household" type batteries. Some of these may be rechargeable. Make sure that the battery being charged is a rechargeable type and that the charger is intended for the battery being charged.

When installing batteries, never mix old batteries with new ones, and never mix different types of batteries. Batteries MUST be installed correctly. Mismatches or incorrect installation may result in overheating and battery case rupture.

Warning:

Do not attempt to disassemble, or incinerate any battery. Keep all batteries away from children. Dispose of used batteries promptly and as regulated by the laws in your area. Note: Check with any retailer of household type batteries in your area for battery disposal information.

Disposal Notice:

Should this product become damaged beyond repair, or for some reason its useful life is considered to be at an end, please observe all local, state, and federal regulations that relate to the disposal of products that contain lead, batteries, plastics, etc. If your dealer is unable to assist you, please contact Yamaha directly.

NAME PLATE LOCATION:

The name plate is located on the bottom of the product. The model number, serial number, power requirements, etc., are located on this plate. You should record the model number, serial number, and the date of purchase in the spaces provided below and retain this manual as a permanent record of your purchase.

Model

Serial No.

Purchase Date

92-BP (bottom)

PLEASE KEEP THIS MANUAL

FCC INFORMATION (U.S.A.)

1. IMPORTANT NOTICE: DO NOT MODIFY THIS UNIT!

This product, when installed as indicated in the instructions contained in this manual, meets FCC requirements. Modifications not expressly approved by Yamaha may void your authority, granted by the FCC, to use the product.

2. IMPORTANT:

When connecting this product to accessories and/or another product use only high quality shielded cables. Cable/s supplied with this product MUST be used. Follow all installation instructions. Failure to follow instructions could void your FCC authorization to use this product in the USA.

3. NOTE:

This product has been tested and found to comply with the requirements listed in FCC Regulations, Part 15 for Class "B" digital devices. Compliance with these requirements provides a reasonable level of assurance that your use of this product in a residential environment will not result in harmful interference with other electronic devices. This equipment generates/uses radio frequencies and, if not installed and used according to the instructions found in the users manual, may cause interference harmful to the operation of other electronic devices. Compliance with FCC regulations does not guar-

antee that interference will not occur in all installations. If this product is found to be the source of interference, which can be determined by turning the unit "OFF" and "ON"; please try to eliminate the problem by using one of the following measures:

Relocate either this product or the device that is being affected by the interference.

Utilize power outlets that are on different branch (circuit breaker or fuse) circuits or install AC line filter/s.

In the case of radio or TV interference, relocate/reorient the antenna. If the antenna lead-in is 300 ohm ribbon lead, change the lead-in to co-axial type cable.

If these corrective measures do not produce satisfactory results, please contact the local retailer authorized to distribute this type of product. If you can not locate the appropriate retailer, please contact Yamaha Corporation of America, Electronic Service Division, 6600 Orangethorpe Ave, Buena Park, CA90620

The above statements apply ONLY to those products distributed by Yamaha Corporation of America or its subsidiaries.

* This applies only to products distributed by YAMAHA CORPORATION OF AMERICA.

(class B)

COMPLIANCE INFORMATION STATEMENT (DECLARATION OF CONFORMITY PROCEDURE)

Responsible Party : Yamaha Corporation of America
Address : 6600 Orangethorpe Ave., Buena Park, Calif. 90620
Telephone : 714-522-9011
Type of Equipment : Drum Trigger Module
Model Name : DTX700

This device complies with Part 15 of the FCC Rules. Operation is subject to the following two conditions:
1) this device may not cause harmful interference, and
2) this device must accept any interference received including interference that may cause undesired operation.
See user manual instructions if interference to radio reception is suspected.

* This applies only to products distributed by YAMAHA CORPORATION OF AMERICA.

(FCC DoC)

PRECAUTIONS

PLEASE READ CAREFULLY BEFORE PROCEEDING

* Please keep this manual in a safe place for future reference.



WARNING

Always follow the basic precautions listed below to avoid the possibility of serious injury or even death from electrical shock, short-circuiting, damages, fire or other hazards. These precautions include, but are not limited to, the following:

Power supply/AC power adaptor

- Do not place the power cord near heat sources such as heaters or radiators, and do not excessively bend or otherwise damage the cord, place heavy objects on it, or place it in a position where anyone could walk on, trip over, or roll anything over it.
- Only use the voltage specified as correct for the instrument. The required voltage is printed on the name plate of the instrument.
- Use the specified adaptor (page 57) only. Using the wrong adaptor can result in damage to the instrument or overheating.
- Check the electric plug periodically and remove any dirt or dust which may have accumulated on it.

Do not open

- This instrument contains no user-serviceable parts. Do not attempt to disassemble or modify the internal components in any way. If it should appear to be malfunctioning, discontinue use immediately and have it inspected by qualified Yamaha service personnel.

Water warning

- Do not expose the instrument to rain, use it near water or in damp or wet conditions, place on it any containers (such as vases, bottles or glasses) containing liquids which might spill into any openings. If any liquid such as water seeps into the instrument, turn off the power immediately and unplug the power cord from the AC outlet. Then have the instrument inspected by qualified Yamaha service personnel.
- Never insert or remove an electric plug with wet hands.

Fire warning

- Do not put burning items, such as candles, on the unit. A burning item may fall over and cause a fire.

If you notice any abnormality

- When one of the following problems occur, immediately turn off the power switch and disconnect the electric plug from the outlet. Then have the device inspected by Yamaha service personnel.
 - The power cord or plug becomes frayed or damaged.
 - It emits unusual smells or smoke.
 - Some object has been dropped into the instrument.
 - There is a sudden loss of sound during use of the instrument.



CAUTION

Always follow the basic precautions listed below to avoid the possibility of physical injury to you or others, or damage to the instrument or other property. These precautions include, but are not limited to, the following:

Power supply/AC power adaptor

- Do not connect the instrument to an electrical outlet using a multiple-connector. Doing so can result in lower sound quality, or possibly cause overheating in the outlet.
- When removing the electric plug from the instrument or an outlet, always hold the plug itself and not the cord. Pulling by the cord can damage it.
- Remove the electric plug from the outlet when the instrument is not to be used for extended periods of time, or during electrical storms.

Location

- Do not place the instrument in an unstable position where it might accidentally fall over.
- Before moving the instrument, remove all connected cables.
- When setting up the product, make sure that the AC outlet you are using is easily accessible. If some trouble or malfunction occurs, immediately turn off the power switch and disconnect the plug from the outlet. Even when the power switch is turned off, electricity is still flowing to the product at the minimum level. When you are not using the product for a long time, make sure to unplug the power cord from the wall AC outlet.

- Use only the stand/rack specified for the instrument. When attaching the stand or rack, use the provided screws only. Failure to do so could cause damage to the internal components or result in the instrument falling over.

Connections

- Before connecting the instrument to other electronic components, turn off the power for all components. Before turning the power on or off for all components, set all volume levels to minimum.
- Be sure to set the volumes of all components at their minimum levels and gradually raise the volume controls while playing the instrument to set the desired listening level.

Handling caution

- Do not insert a finger or hand in any gaps on the instrument.
- Never insert or drop paper, metallic, or other objects into the gaps on the panel. This could cause physical injury to you or others, damage to the instrument or other property, or operational failure.
- Do not rest your weight on, or place heavy objects on the instrument, and do not use excessive force on the buttons, switches or connectors.
- Do not use the instrument/device or headphones for a long period of time at a high or uncomfortable volume level, since this can cause permanent hearing loss. If you experience any hearing loss or ringing in the ears, consult a physician.

Yamaha cannot be held responsible for damage caused by improper use or modifications to the instrument, or data that is lost or destroyed.

Always turn the power off when the instrument is not in use.

Even when the power switch is in standby status, electricity is still flowing to the instrument at the minimum level. When you are not using the instrument for a long time, make sure you unplug the power cord from the wall AC outlet.

NOTICE

To avoid the possibility of malfunction/ damage to the product, damage to data, or damage to other property, follow the notices below.

■ Handling and Maintenance

- Do not use the instrument in the vicinity of a TV, radio, stereo equipment, mobile phone, or other electric devices. Otherwise, the instrument, TV, or radio may generate noise.
- Do not expose the instrument to excessive dust or vibrations, or extreme cold or heat (such as in direct sunlight, near a heater, or in a car during the day) to prevent the possibility of panel disfiguration, damage to the internal components or unstable operation. (Verified operating temperature range: 5° – 40°C, or 41° – 104°F.)
- Do not place vinyl, plastic or rubber objects on the instrument, since this might discolor the panel or keyboard.
- When cleaning the instrument, use a soft, dry/dry or slightly damp cloth. Do not use paint thinners, solvents, cleaning fluids, or chemical-impregnated wiping cloths.

■ Saving data

- Saved data may be lost due to malfunction or incorrect operation. Save important data to a USB storage device/external device such as a computer.
- To protect against data loss through media damage, we recommend that you save your important data onto two USB storage devices/external media.

Information

■ About copyrights

- Copying of the commercially available musical data including but not limited to MIDI data and/or audio data is strictly prohibited except for your personal use.
- This product incorporates and bundles computer programs and contents in which Yamaha owns copyrights or with respect to which it has license to use others' copyrights. Such copyrighted materials include, without limitation, all computer software, style files, MIDI files, WAVE data, musical scores and sound recordings. Any unauthorized use of such programs and contents outside of personal use is not permitted under relevant laws. Any violation of copyright has legal consequences. DON'T MAKE, DISTRIBUTE OR USE ILLEGAL COPIES.

■ About this manual

- The illustrations and LCD screens as shown in this manual are for instructional purposes only, and may appear somewhat different from those on your instrument.
- The company names and product names in this manual are the trademarks or registered trademarks of their respective companies.

Welcome

Thank you for purchasing the Yamaha DTX700 Drum Trigger Module.
To get the most out of your new instrument, be sure to read this owner's manual carefully.
And after reading through this manual, be sure to store it in a safe place so
that you can refer back to it again as needed.

Using the Manuals

Owner's Manual – this booklet (Setup / Basic Operation)

This paper manual describes the basic operations performed via the DTX700's control panel.

Data List

The *Data List* contains the names of all of the DTX700's sounds and kits, together with MIDI-related reference material.

Reference Manual (Detailed Operation) *Not bundled with this product.

The *Reference Manual* provides a description of all of the functions that can be accessed by pressing the [MENU] button on the DTX700's control panel. This PDF manual is not bundled with the drum trigger module. If you wish to learn more about your DTX700 using the *Reference Manual*, please download it from the Yamaha Manual Library web page:

<http://www.yamaha.co.jp/manual/>

* Yamaha Corp. reserves the right to modify this URL at any time without prior notice.

Using PDF Manuals

The *Reference Manual* for your DTX700 is made available in digital format as a PDF document. As such, a computer and suitable software will be required in order to read it. We recommend that Adobe Reader be used for this purpose as it allows you to quickly and easily search for keywords, to print out specific sections, and to conveniently jump from page to page by clicking embedded links. Keyword searching and link-based navigation in particular are extremely useful functions available only with digital-type documents. The most-recent version of Adobe Reader can be downloaded from the following web page.

<http://www.adobe.com/products/reader/>

Bundled items

- Power adaptor
- Owner's Manual (this booklet)
- Data List
- DVD-ROM (containing DAW software)
- Module holder
- Module-holder fixing screws x 4

■ Latest Firmware Version

From time to time, Yamaha may update product firmware without prior notice. We recommend, therefore, that you check our web site (below) for the latest version and keep your DTX700 firmware up to date.

<http://dtxdrums.yamaha.com/downloads/>

The content of this Owner's Manual applies to the newest version of the firmware as of printing. Details regarding any functions added to later versions will also be made available via the above web site.

■ Optional Pads

Within this Owner's Manual, the optional external pads that may be connected to the DTX700 are referred to by model name. Please note that these model names were up-to-date as of printing of this manual. Details regarding any subsequently released models will be made available via the following web site.

<http://dtxdrums.yamaha.com/downloads/>

Contents

Welcome	5
Using the Manuals	5
Bundled items	5
Contents.....	6
First Steps.....	7
Quick Start Guide	8

Setup

Component Names & Functions.....	10
Control Panel.....	10
Side Panel	11
Rear Panel	12
Setting Up for Sound	13
Connecting the Adaptor.....	13
Connecting Speakers or Headphones	13
Connecting a Music Player.....	13
Turning On.....	14
Turning Off.....	14
Auto Power-Off.....	14

Basic Operation

Playing Demo Songs	16
Basic DTX700 Operations	17
Dial (with integrated button).....	17
Changing the Cursor Value	17
Moving the Cursor	17
[-/DEC] and [+/INC] Buttons	18
[F1], [F2] & [F3] Function Buttons.....	18
Adjusting the Volume.....	19
Adjusting Display Contrast	19
Storing Settings	21
Connecting a USB Memory Device.....	21
Restoring Default Settings	22
Playing Drum Pads.....	23
Snare & Toms	23
Hi-Hats	23
Cymbal	24
Performing on Many Different Kits	25
Selecting a Kit	25
Selecting a Sensitivity for the Entire Kit.....	26
Adjusting Tone.....	27
Turning Off Effects	28
Initializing a Kit	28
Switching the Display Mode	29

Building Your Own Kit.....	30
Selecting Sounds (Instruments)	30
Adjusting an Instrument's Sound.....	31
Playing with a Double Bass Drum	32
Importing & Assigning Audio Files.....	32
Naming an Original Kit	34
Adjusting the Snare Wire.....	35
Playing with Songs for Practice.....	36
Playing a Song	36
Adjusting the Song Volume	36
Adjusting the Volume of a Song's Drums	37
Muting the Drum Part	38
Soloing the Bass Part.....	38
Locking a Kit.....	39
Turning On the Click-Track	41
Setting the Tempo and Starting the Click-Track.....	41
Setting the Click-Track Volume	41
Setting the Time Signature	43
Using the Timer	44
Tap Tempo – Setting the Tempo by Playing Pads.....	44
Using DTX700 Training Functions	45
Recording Your Performances	48
Recording a Performance.....	48
Playing a Recorded Performance	48
Deleting a Recorded Performance	48
Recording Performance & Song Together	49
Integrating Accessories	50
Using an HH65 Hi-hat Controller as Kick Drum Pedal	50
Expanding with a PCY135 Cymbal Pad.....	50
Connecting Your DTX700 to a Computer	52
Making Connections.....	52
Making Music with a Computer	53
Setting up Cubase Remote Control	54
On-Screen Messages	55
Troubleshooting	56
Specifications	57
Index	58
List of DTX700 Functions	59

* For details regarding these functions, refer to the *Reference Manual* PDF document.

Quick Start Guide

Choosing sounds to play (page 25 of Basic Operation)

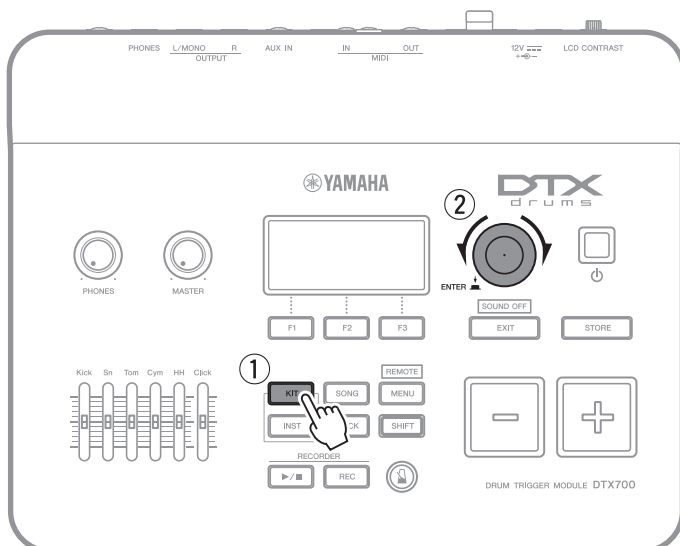

- ① Press the [KIT] button.
- ② Turn the dial to select new sounds.

You can also assign sounds individually to each of the pads (page 25 of Basic Operation).

Playing along with a song (page 36 of Basic Operation)

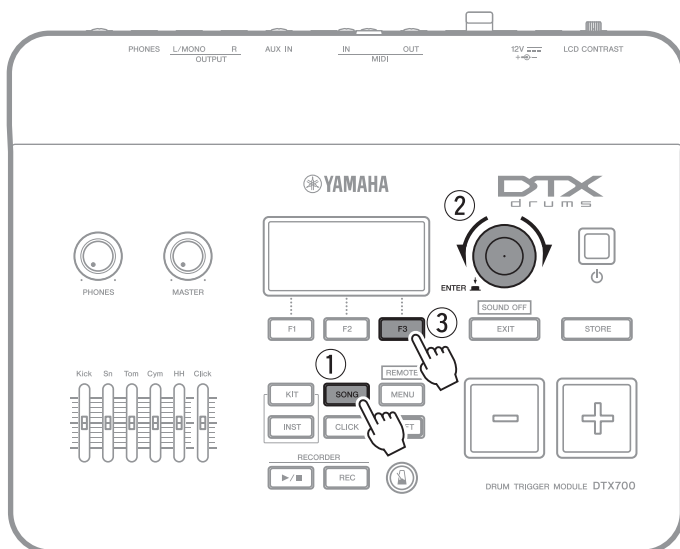

- ① Press the [SONG] button.
- ② Turn the dial to select a new song.
- ③ Press the [F3] button to start the song.

You can press the [F2] button to silence the song's drum part (page 38 of Basic Operation).

Practicing with a metronome (page 41 of Basic Operation)

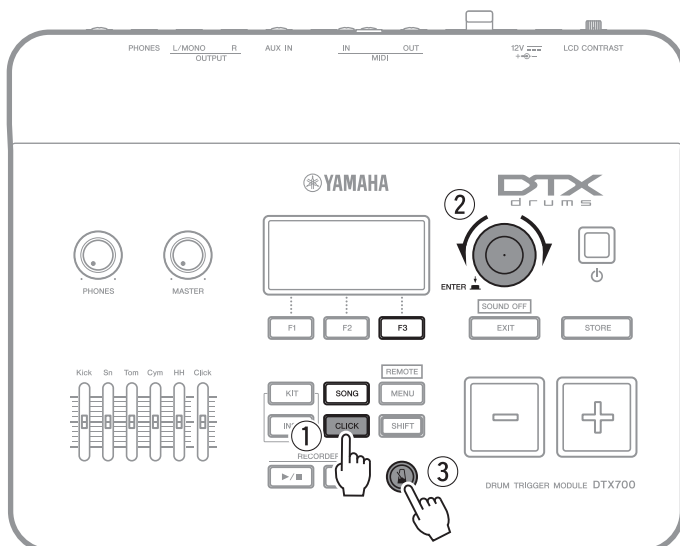

- ① Press the [CLICK] button.
- ② Turn the dial to set the tempo.
- ③ Press the [MUTE] button to start the metronome.

Recording your own performance (page 48 of Basic Operation)

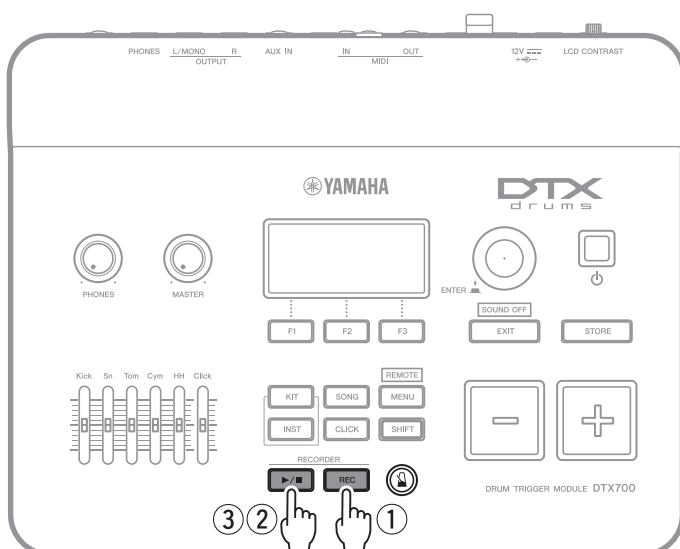

- ① Press the [REC] button.
- ② Press the [▶/■] button to start recording.
- ③ When you have finished playing, press the [▶/■] button once again to stop recording.

You can also use the [▶/■] button to start and stop playback of your recorded performance (page 48 of Basic Operation).

Component Names & Functions

Control Panel

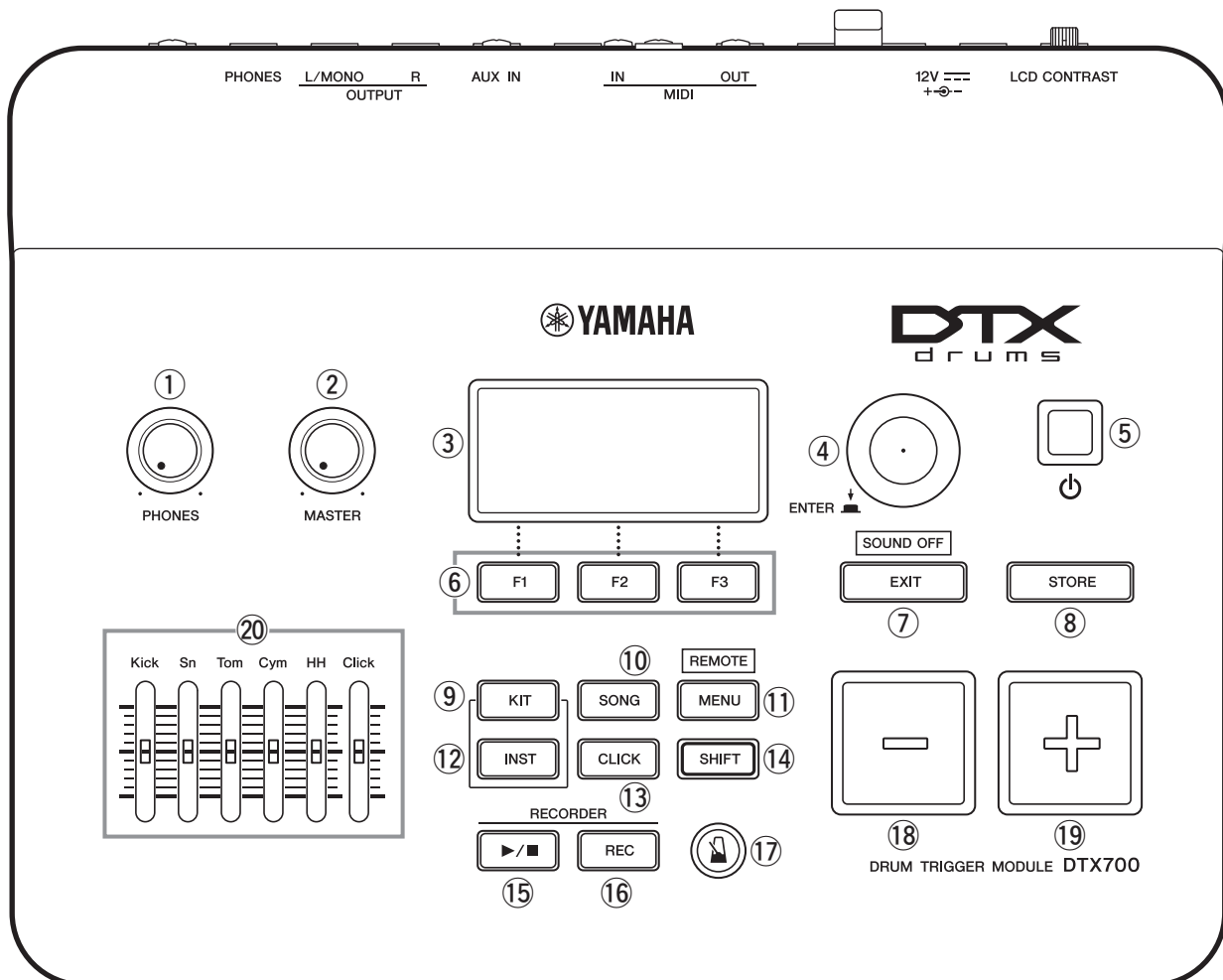

① [PHONES] volume knob (page 13)

This knob controls the volume of audio output from the [PHONES] jack. Turn clockwise to increase the volume or counter-clockwise to decrease it.

② [MASTER] knob (page 19)

This knob controls the DTX700 master volume (i.e., the volume at the OUTPUT jacks). Turn clockwise to increase the volume or counter-clockwise to decrease it.

③ Display (page 29)

This LCD screen shows information and data needed to operate the DTX700.

④ Dial (page 17)

This dial can be both turned and pressed.

- By pressing it, you can set parameter values and execute various functions such as the storing of data.
- By turning it, you can move the cursor within displayed pages and change the currently selected parameter value.

⑤ ⏻ (Standby/On) button (page 14)

Use this switch to turn your DTX700 on and off.

⑥ [F1], [F2], and [F3] function buttons (page 18)

These buttons are used to access a range of different functions depending on the page displayed.

⑦ [EXIT] button

Press this button to cancel operations such as the copying and storing of data. In addition, you can immediately silence all voices at any time by holding down the [SHIFT] button and pressing the [EXIT] button.

⑧ [STORE] button (page 21)

This button is used to store settings and other data in the DTX700's internal memory. In addition, it will light up whenever parameter settings have been changed but not yet stored.

⑨ [KIT] button (page 25)

This button is used to access the Kit page in order to select a drum kit.

⑩ **[SONG] button** (page 36)

This button is used to access the Song page in order to select a song.

⑪ **[MENU] button** (page 20)

This button is used to access the Menu area. From here, you can select various other pages in order to configure your DTX700 in many different ways.

* This booklet introduces some of the basic functions available in the Menu area. For a complete description of all functions, please download the DTX700 *Reference Manual* from this web page:

<http://www.yamaha.co.jp/manual/>

⑫ **[INST] button** (page 30)

This button is used to access the Instrument page in order to select instruments.

[Definition] Instrument

In the context of the DTX700, the term “instrument” is used to refer to each of the various percussion instruments that make up a kit. Typical examples would be snare drums, tom-toms, cymbals, and kick drums.

⑬ **[CLICK] button** (page 41)

This button is used to access the Click page in order to set your DTX700’s click-track (or metronome).

⑭ **[SHIFT] button**

When you press this button, the functions assigned to the [F1], [F2], and [F3] buttons will change. These functions can be accessed by holding down the [SHIFT] button and pressing the corresponding function button (see page 18). Meanwhile, a number of the buttons on the DTX700’s control panel have secondary functions, indicated just above the buttons themselves. These functions can also be accessed by holding down the [SHIFT] button and pressing the corresponding button.

⑮ **[▶/■] button** (page 48)

Use this button to start and stop the playback of performances that you have recorded on the DTX700.

⑯ **[REC] button** (page 48)

Using this button, you can activate and deactivate recording of your performances.

⑰ **[👉] (Click-track) button** (page 41)

The Click-track button is used to start and stop the DTX700’s click-track (or metronome).

⑱ **[-/DEC] button** (page 18)

This button is used to decrease the value at the cursor position. In addition, the selected value can be decreased in units of 10 by holding down the [SHIFT] button and pressing the [-/DEC] button or by holding down the [-/DEC] button and pressing the [+ /INC] button.

⑲ **[+ /INC] button** (page 18)

This button is used to increase the value at the cursor position. In addition, the selected value can be increased in units of 10 by holding down the [SHIFT] button and pressing the [+ /INC] button or by holding down the [+ /INC] button and pressing the [- /DEC] button.

⑳ **Sliders** (page 41)

The sliders are used to adjust the volumes of individual parts such as the snare and toms, and also the volume of the click-track.

Side Panel

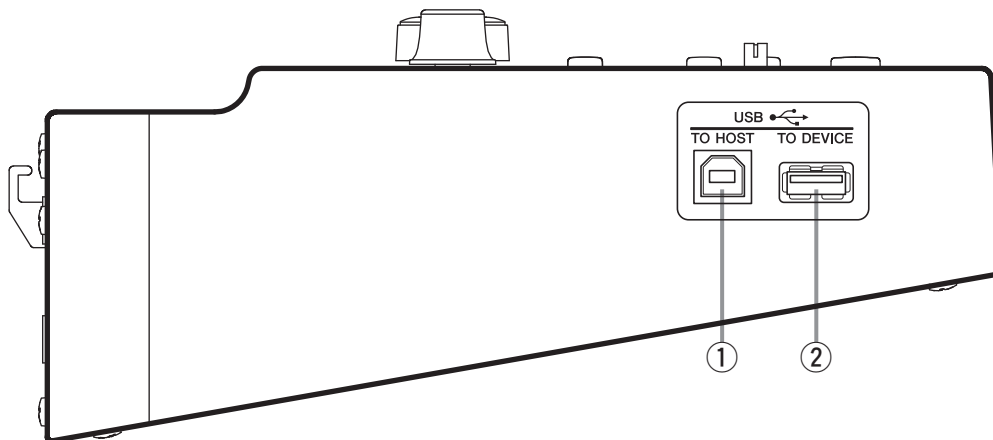
① **[USB TO HOST] port** (page 52)

This port is used to connect the DTX700 to a computer via a USB cable.

② **[USB TO DEVICE] port** (page 21)

This port is used to plug in a USB memory device (such as a flash drive), either directly or via a USB cable.

Rear Panel

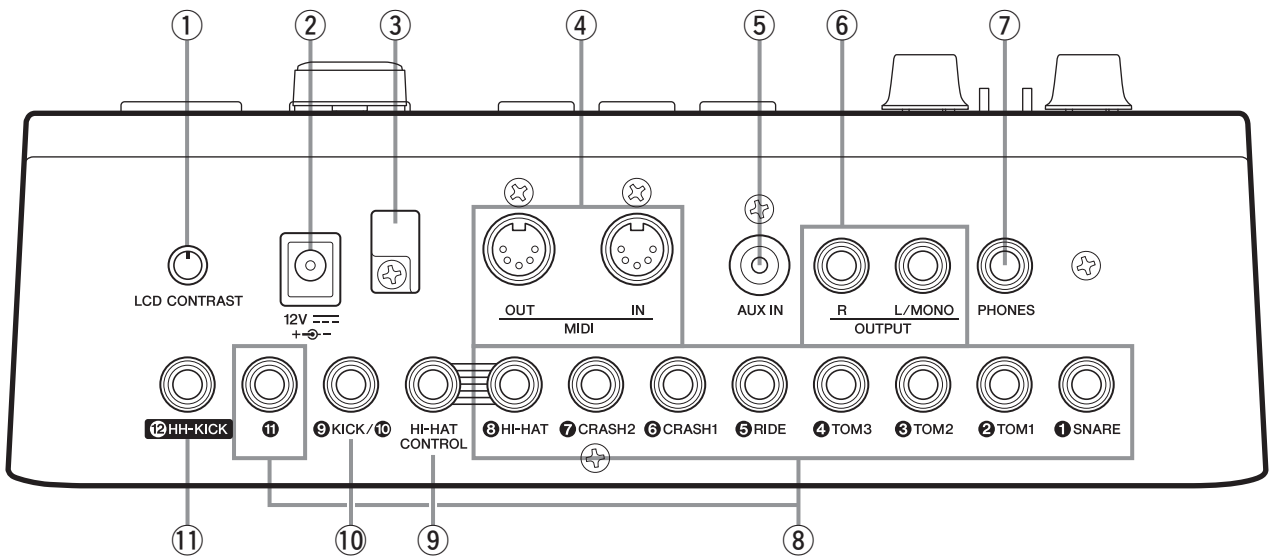

① **[LCD CONTRAST] knob** (page 19)
This knob is used to set the display contrast for optimum legibility.

② **[12V \equiv + \ominus -] connector** (page 13)
Use this connector for the power adaptor that came with your DTX700.

③ **Cord clip** (page 13)
Wrap the power adaptor cord around this clip to prevent accidental unplugging during operation.

④ **MIDI [IN] and [OUT] connectors** (page 13)
The MIDI [IN] connector is used to receive control or performance data from another MIDI device, such as an external sequencer, via a MIDI cable. When connected in this way, you can play the DTX700's internal tone generator and control many of its parameters using another MIDI device. Meanwhile, the MIDI [OUT] connector is used to send performance data from the DTX700 to other devices in the form of MIDI messages.

⑤ **[AUX IN] (auxiliary input) jack** (page 13)
External audio signals can be input via this stereo mini-jack. Using [AUX IN], you can connect a portable music player, a CD player, or another similar device to play along with your favorite tunes.

⑥ **OUTPUT [L/MONO] and [R] jacks** (page 13)
Use these jacks to output line-level stereo mixes from your DTX700. For example, you can connect each of the jacks to the left and right inputs of an external stereo amplifier or mixer using mono audio-jack cables. For mono output, use the [L/MONO] jack only.

⑦ **[PHONES] jack** (page 13)
Use this standard audio jack to connect a pair of stereo headphones.

⑧ **Trigger input jacks [①SNARE] to [⑧HI-HAT], and [⑪]**

These trigger-input jacks are used to connect stereo-type pads (two- and three-zone). They also support standard mono-output pads. In addition, these trigger-input jacks are compatible with pad controllers.

⑨ **[HI-HAT CONTROL] jack**

This jack is used to connect an HH65 Hi-hat Controller or an RHH135 Real Hi-hat Pad via its control output.

⑩ **Trigger input jack [⑨KICK/⑩]**

This trigger-input jack is used to connect mono-type pads such as the KP65 Kick Pad. If using a KP65, furthermore, you can use the input jack on its rear surface to connect an additional mono-type pad. Meanwhile, you could also use a Y-shaped cable (sold separately) with this jack in order to connect a pair of mono-type pads.

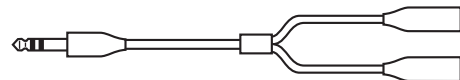

⑪ **Trigger input jack [⑫HH-KICK]**

This jack is used to connect an HH65 Hi-hat Controller (sold separately) for use as an alternative kick pad or as part of a double bass drum configuration (page 50).

Turning On

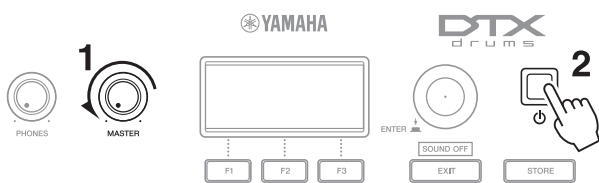

1 Turn the [MASTER] knob fully counterclockwise to minimize the output volume.

2 Press the (Standby/On) button.

The opening pages will be displayed, followed by the Kit page.



3 If you have connected any amplified speakers or other similar external devices, turn them on now.

NOTE

- When powering down your system, be sure to turn off external devices before the DTX700.

Turning Off

1 Press the (Standby/On) button.

The display will turn off.

NOTICE

- If you turn off the DTX700 without storing any changes you have made to settings, those changes will be lost. For details on how to store changed settings, see page 21.

Auto Power-Off

If no controls are operated or no data is exchanged with external devices (such as a computer or MIDI instrument) for a predetermined length of time, your DTX700 will turn off automatically. This function is called Auto Power-Off.

NOTICE

- If you do not store changed settings before the Auto Power-Off function activates, your changes may be permanently lost. Be sure, therefore, to store new settings whenever you are happy with them.

● **Setting the Auto Power-Off Function**

Use the following procedure to set the time until the Auto Power-Off function activates or to disable the function.

1 Press the [MENU] button.



2 Turn the dial to move the cursor to “Utility”

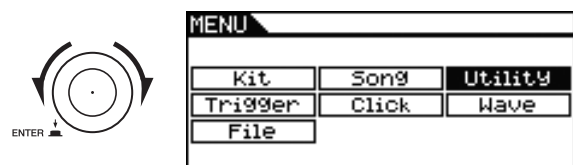

3 Press the dial.

4 Turn the dial to move the cursor to “General”

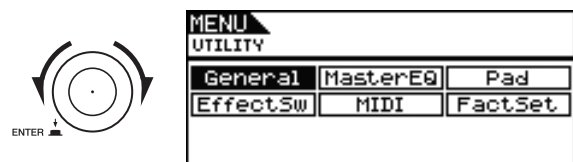

5 Press the dial.

6 Turn the dial to move the cursor to the “AutoPowerOff” row of the displayed list.

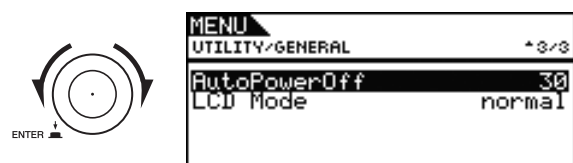

7 Press the dial.

The cursor will zoom in on the value on the right.

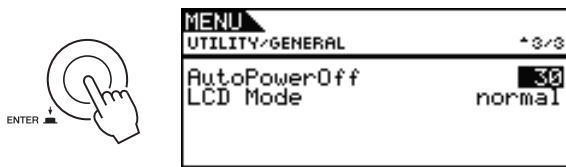

8 Turn the dial to set the automatic power-off time.

The value indicates the idle time until automatic power-off in minutes. Settings can be made in units of 5 minutes between 5 and 30. Furthermore, you can disable the Auto Power-Off function by selecting “off”.

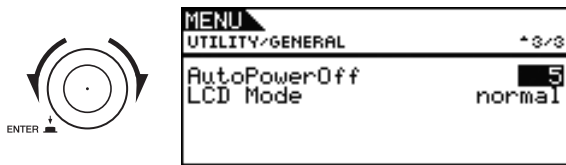

9 Press the dial.

The cursor will zoom out to select the entire row.

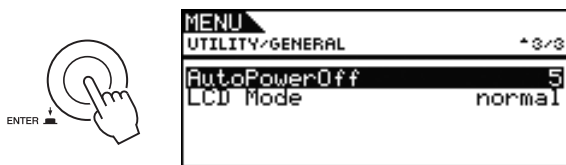

10 Press the [STORE] button.



11 Press the dial to store your new settings.

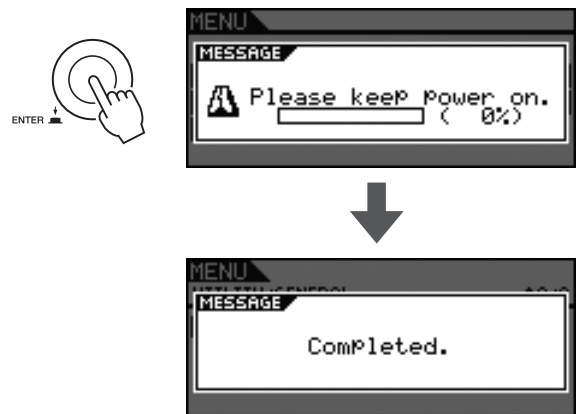

NOTE

- The Auto Power-Off function is set to 30 minutes by default.

● Disabling the Auto Power-Off Function at Startup

To disable the Auto Power-Off function when turning on the DTX700, hold down the [▶/■] button when you press the ⏻ (Standby/On) button. (This action sets the AutoPower-Off parameter to “Off”.)



Playing Demo Songs

Your DTX700 comes pre-programmed with demo songs. Played as described below, these songs allow you to fully appreciate the quality of the sound produced by the built-in tone generator.

- 1 Press the  (Standby/On) button to turn on your DTX700.

Startup pages

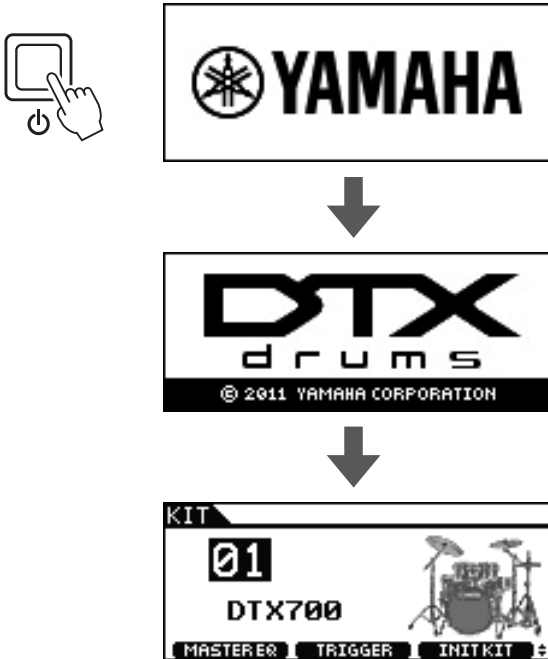

- 2 Press the [SONG] button.



- 3 Press the [F3] button.

The demo song indicated on the display will start. The [SONG] button will flash while the song is playing.



- 4 Press the [F3] button once again to stop the demo song.



- 5 To select a different demo song, turn the dial and repeat Steps 3 and 4.



Basic DTX700 Operations

Dial (with integrated button)

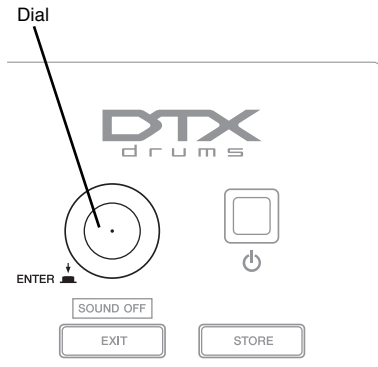

● Pressing the dial



You press the dial to execute various operations and to set new values for parameters. The cursor type (see below) can also be toggled by pressing the dial.

● Turning the dial

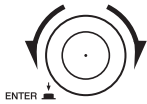

You turn the dial to change parameter values and to move the cursor.

Changing the Cursor Value

The cursor is displayed as a block of inverted text.



By turning the dial in either direction, you can change the value at the current cursor position.



Moving the Cursor

When a page contains more than one editable value, you can press the dial to toggle between inverted text and underlined text at the cursor position.

Example: After pressing the [SONG] button

On the page accessed with the [SONG] button, you can set both the song number **01** and the tempo **J=120**.



Press the dial to switch to the underline cursor.



By turning the dial, you can move the cursor. In this way, you can select the value you wish to change.

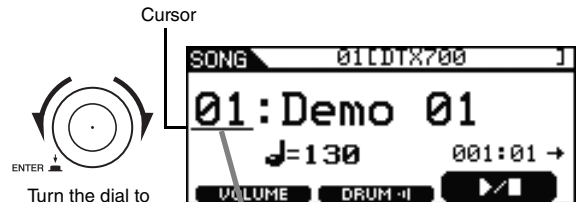

Turn the dial to move the underline



Press the dial once again to switch back to the inverted-text cursor.



By turning the dial in either direction, you can change the value at the cursor position.



[-/DEC] and [+ /INC] Buttons

These buttons are used to change the currently selected value. Press the [+ /INC] button to increase the value by one; the [- /DEC] button to decrease by one. If you hold down either button, the value will change continuously. In the case of parameters with a wide range of possible settings, you can increase them in units of 10 by holding down the [SHIFT] button and pressing the [+ /INC] button or by holding down the [+ /INC] button and pressing the [- /DEC] button. Similarly, you can decrease in units of 10 by holding down the [SHIFT] button and pressing the [- /DEC] button or by holding down the [- /DEC] button and pressing the [+ /INC] button.

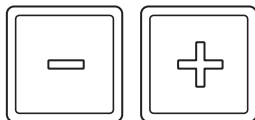

[F1], [F2] & [F3] Function Buttons

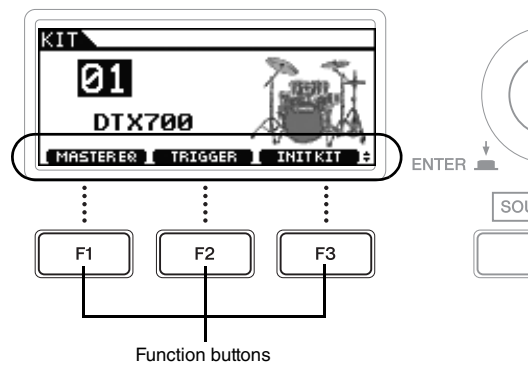

The functions that you can access by pressing the [F1], [F2], and [F3] function buttons are displayed as inverted text at the bottom of the display. In addition, when the \blacklozenge symbol is shown in the bottom right corner, you can press the [SHIFT] button to display additional functions for each of the buttons.



To access these additional functions, hold down the [SHIFT] button and press the corresponding button.

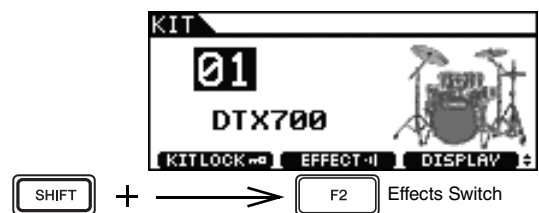

Adjusting the Volume

You can use the [MASTER] knob to adjust the volume of sound on the OUTPUT [L/MONO] and [R] channels. In addition, the [PHONES] knob can be used to adjust the volume of headphones plugged into the [PHONES] jack on the rear panel. Turn clockwise to increase the volume or counter-clockwise to decrease it.

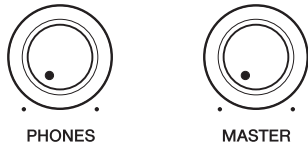

Adjusting Display Contrast

Using the [LCD CONTRAST] knob on the rear panel, you can adjust the contrast level of the DTX700 display.

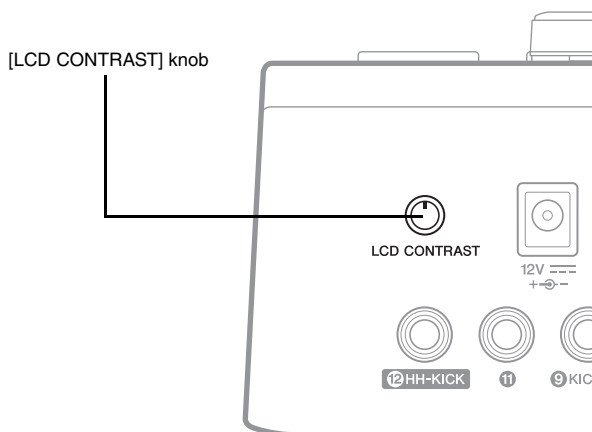

Pages Accessed Using the [MENU] Button

The pages of your DTX700's Menu area provide access to a wide range of highly-useful settings. To access this area, simply press the [MENU] button. This manual introduces some of the pages from the Menu area. For a complete description, please download the DTX700 *Reference Manual* from this web page:

<http://www.yamaha.co.jp/manual/>

• Cursor operations on Menu area pages

The way in which the cursor is displayed and operated on Menu area pages differs from that of other pages.

• Navigation pages

MENU		
Kit	Song	Utility
Trigger	Click	Wave
File		

When you turn the dial on navigation-type pages, the cursor (i.e., the inverted text) moves in the corresponding direction.

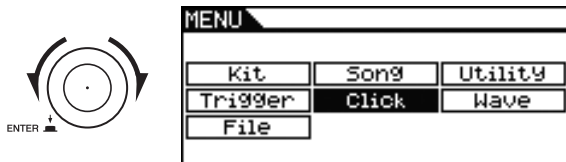

By pressing the dial, you can move one level further into the Menu area.

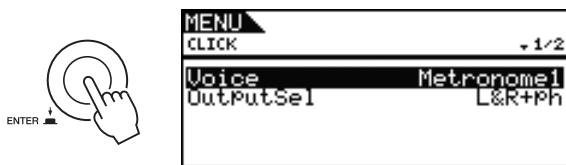

To move back one step towards the top page, press the [EXIT] button.

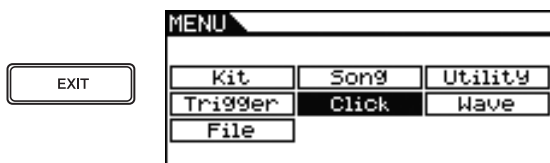

NOTE

- The convention used in this manual to describe sequences of cursor operations in the Menu area takes the form: [MENU] → [KIT] → [COMMON].

• Parameter pages

MENU	
KIT/COMMON	
Volume	100
Tempo	130
TrgSetupLink	off
Name	[DTX700]
Icon	Acoustic

When you turn the dial on parameter-type pages, the cursor (i.e., the inverted text) moves up and down within the displayed list.



When you press the dial, the cursor will zoom in on the value on the right.



In this condition, you can turn the dial to change the value selected by the cursor.



When you press the dial again, the cursor will zoom out to select the entire row.

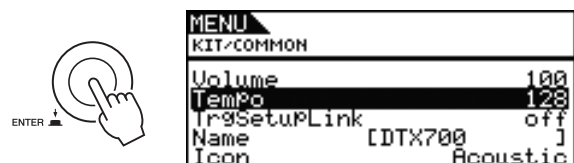

Storing Settings

Whenever you change a DTX700 setting, the [STORE] button will light up to remind you to store your new setting in the instrument's internal memory. To do so, proceed as follows.

1 Make sure that the [STORE] button is lit.



2 Press the [STORE] button.

You will be asked to confirm that you wish to proceed.



NOTE

- You can press the [EXIT] button to return to the previous page without storing.

3 Press the dial to store your settings.

The [STORE] button will go out, confirming that your settings have been permanently stored.

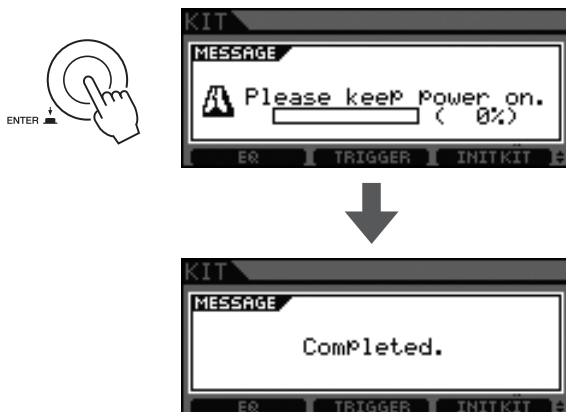

NOTICE

- If you turn off the DTX700 without storing any changes you have made to settings, those changes will be lost.

Connecting a USB Memory Device

You can plug a USB memory device into the [USB TO DEVICE] port on the side panel of your DTX700.

● Precautions when using the [USB TO DEVICE] port

Whenever connecting a USB device to your DTX700 via the [USB TO DEVICE] port, be sure to observe the following important precautions.

NOTICE

- Use a USB A-B cable of no more than 3 meters in length.

NOTE

- For more details on how to use your USB memory device, refer to the owner's manual that came with it.

Supported USB memory devices

Flash drives and other USB-compatible, mass storage devices may be used with the DTX700.

This instrument does not necessarily support all commercially available USB memory devices, and Yamaha cannot guarantee the operation of all such devices. Before purchasing a USB device for use with this instrument, therefore, please check with your Yamaha dealer or an authorized Yamaha distributor, or visit this web page:

<http://dtxdrums.yamaha.com/>

NOTE

- Other USB devices, such as a computer keyboard or mouse, are not supported.

Connecting a USB memory device

Before plugging in a USB memory device, ensure that its connector matches the shape of the DTX700's [USB TO DEVICE] port and that both are oriented in the same direction. The [USB TO DEVICE] port supports the USB 1.1 standard; however, you can plug in and use USB 2.0 memory devices. It should be noted that data will be transferred at the USB 1.1 speed in such a case.

NOTE

- USB 3.0 cables cannot be connected to the DTX700.

● Using a USB memory device

With a USB memory device plugged into the DTX700, you will be able to save data that you have created and to import settings and audio data.

Initializing a USB memory device

Certain types of USB memory device must be initialized before they can be used with this instrument. For details on how to do this, refer to the *Reference Manual* PDF document.

NOTICE

- When a USB memory device is initialized, all data saved on it will be permanently erased. Before formatting such a device, therefore, ensure that any important data has been copied to another location.

Write protection

Certain types of USB memory device can be write-protected to prevent data from being accidentally erased. If your USB memory contains important data, we suggest that you activate write protection to prevent accidental erasure. Meanwhile, if you need to save data on a USB flash-memory device, be sure to disable its write protection.

NOTICE

- If using a self-powered type USB memory device, turning it on and off repeatedly could cause your DTX700 to freeze and stop operating. The same applies to the frequent plugging in and unplugging of USB cables. Such action should, therefore, be avoided.
- Data stored on the DTX700 or within the USB memory device may be corrupted if they are disconnected or turned off at the wrong time. Be sure, therefore, to avoid unplugging the USB memory device from the [USB TO DEVICE] or turning off either device while data is being transferred.

Restoring Default Settings

Straight out of the box, your DTX700 already contains a wide range of pre-programmed drum kits, instruments, and songs. This collection of default settings – the Factory Set – can be conveniently restored at any time if you have accidentally overwritten them or wish to delete all of your own settings. To do so, use the Factory Set function as follows.

1 Press the [MENU] button.



2 Turn the dial to move the cursor to “Utility”

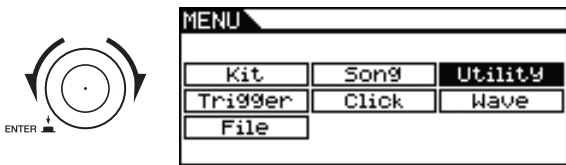

3 Press the dial.

4 Turn the dial to move the cursor to “FactSet”

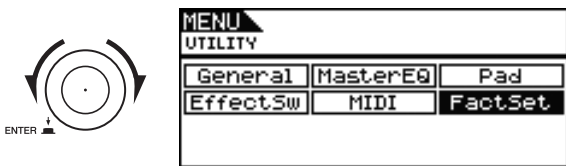

5 Press the dial.

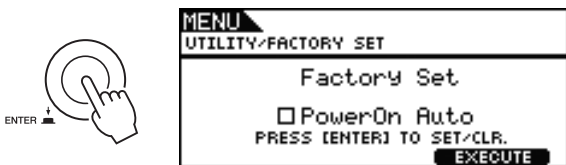

6 Press the [F3] button.

You will be asked to confirm that you wish to restore the Factory Set.

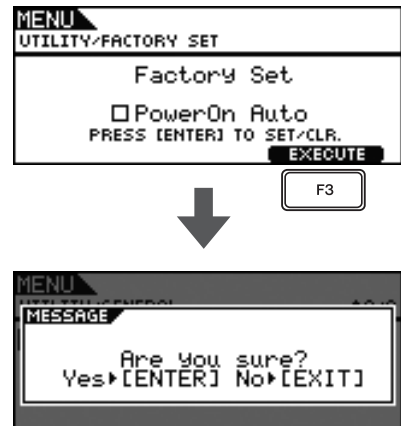

If you do not wish to do so, press the [EXIT] button to return to the previous page.

7 Press the dial to restore the Factory Set.

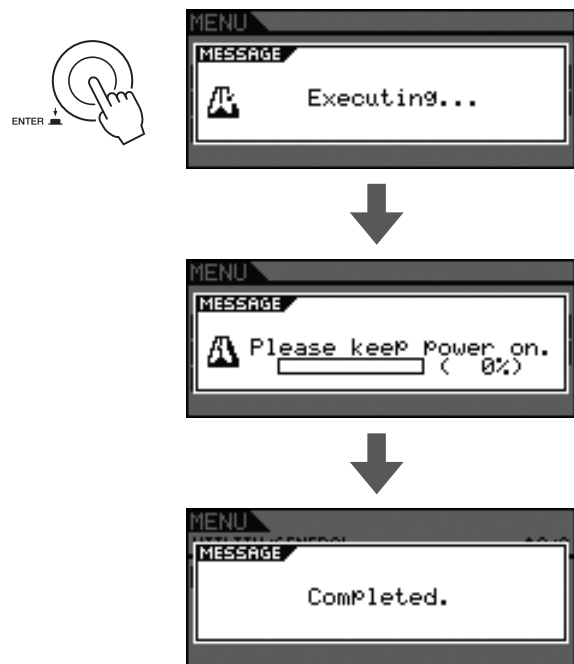

NOTICE

- Whenever the Factory Set is restored, any settings you have made will be overwritten with the corresponding defaults. Important user-defined data should, therefore, be saved on a USB memory device in advance. For full details, refer to the *Reference Manual* PDF document.

NOTE

- If you select the “PowerOn Auto” checkbox on the page displayed for Step 6 above, the Factory Set will be restored each time you turn on your DTX700.

Playing Drum Pads

Snares & Toms

If using a three zone pad such as the XP100SD shown below, you will be able to produce three distinct sounds (i.e., head, open rim, closed rim) depending on where you hit it, much the same as if you were playing an acoustic snare.

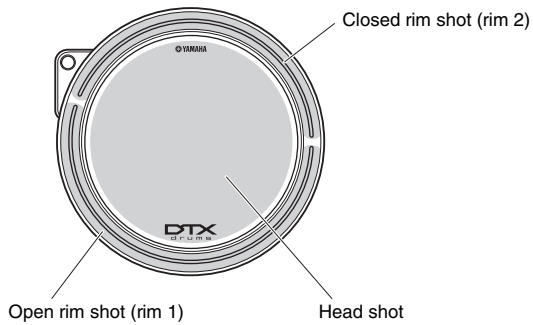

● Head shot

Hitting the main surface of the pad produces a head shot sound.

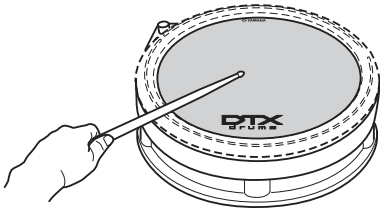

● Open rim shot

Hitting the open-rim zone produces an open rim-shot sound.

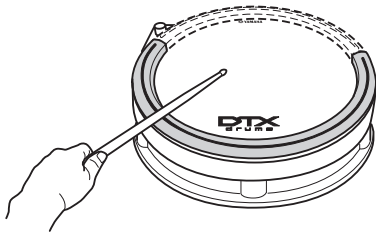

● Closed rim shot (Cross sticking)

Hitting the closed-rim zone produces a closed rim-shot sound.



Hi-Hats

If using a two zone pad such as the RHH135 shown below, you will be able to play it in the same way as an acoustic hi-hat cymbal.

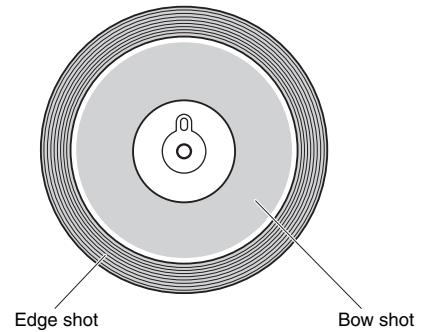

● Open/close

In addition to the foot-close sound obtained by pressing the Hi-Hat Controller pedal, you can press the controller down even more firmly in the closed condition to produce a tighter closed hi-hat sound.

● Bow shot

Hitting the main surface of the pad (i.e., the bow section located between the cup and edge) produces a bow shot sound.

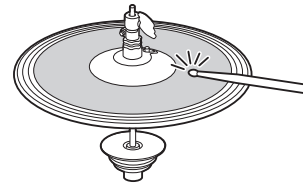

● Edge shot

Hitting the outside edge of the pad produces an edge shot sound.

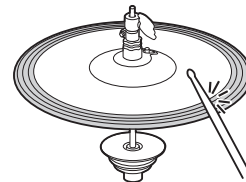

● Hi-hat splash

Pressing the hi-hat controller pedal and then immediately releasing it produces a hi-hat splash sound.

Cymbal

If using a three zone pad such as the PCY135 shown below, you will be able to play it in the same way as an acoustic ride cymbal.

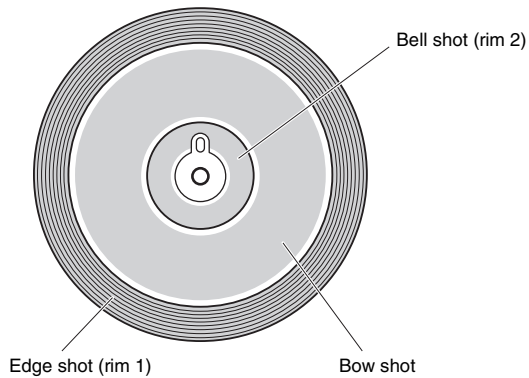

● Bow shot

Hitting the main surface of the pad (i.e., the bow section located between the cup and edge) produces a bow shot sound.

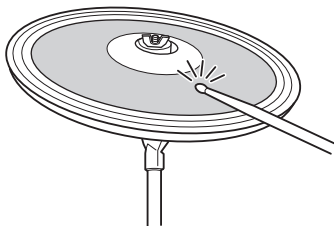

● Edge shot

Hitting the outside edge of the pad produces an edge shot sound.

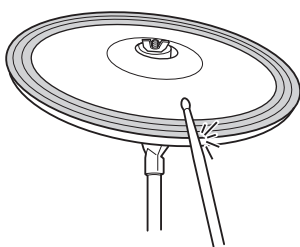

● Bell shot

Hitting the cup produces a bell shot sound.

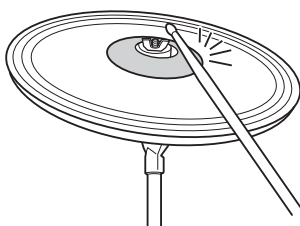

● Choking

Grabbing the edge of a cymbal pad immediately after hitting it will silence the sound being produced.

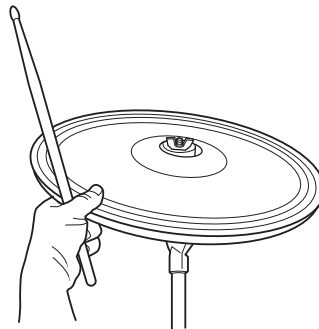

● Muting

Hitting the pad while holding the edge will produce a muted sound.

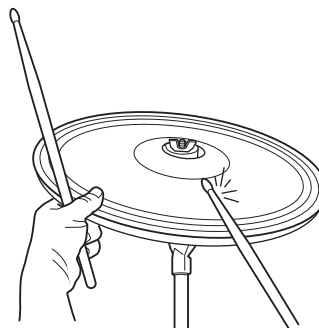

Performing on Many Different Kits

In terms of the DTX700, the word “kit” is used to refer to a collection of related sounds, such as acoustic drums or percussion instruments. By selecting different kits, you can conveniently change the entire sound of this drum trigger module.



Acoustic drums



Percussion instruments

Selecting a Kit

1 Press the [KIT] button.



2 Turn the dial to choose a new kit.

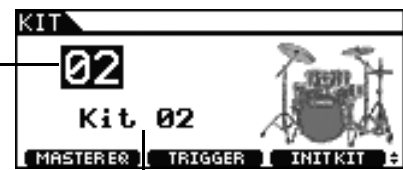

Kit number

Kit name

3 Play the connected pads.

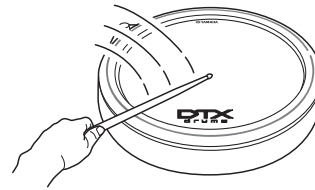

NOTE

- When you select a new kit in Step 2 above, the [STORE] button will light up. You can press the button at this time to store your new kit selection. When you next turn on the DTX700, therefore, this kit will be automatically selected.

Selecting a Sensitivity for the Entire Kit

With electronic drums, sensitivity is often set for each individual pad. However, doing so before each performance can be extremely time consuming. As a solution, your DTX700 contains a number of trigger setups that define the sensitivities of all pads in a kit.

These trigger setups have been carefully designed to suit a range of different playing situations and pad sets, and they can be selected as follows.

1 Press the [KIT] button.



2 Press the [F2] button.

The Trigger Setup page will open.

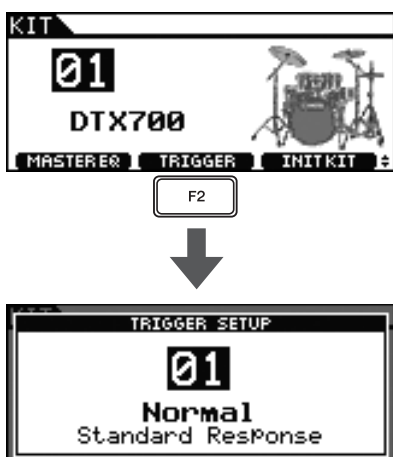

3 Turn the dial to choose a trigger setup.

Playing your DTX700's pads as you turn the dial makes it easier to notice the differences in sensitivity levels.

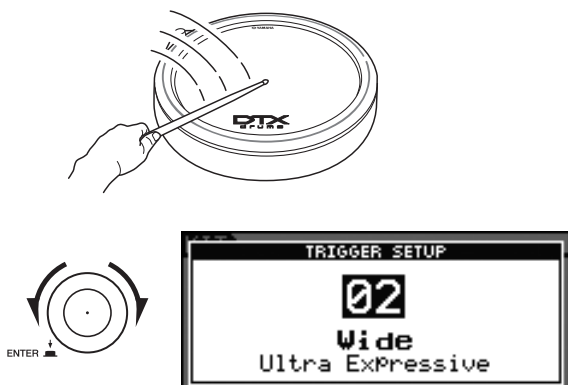

4 When you have found a trigger setup you like, press the [EXIT] button to return to the Kit page.



5 Press the [STORE] button.



If you do not wish to store your setting, press the [EXIT] button to return to the previous page.

6 Press the dial to store your new setting.

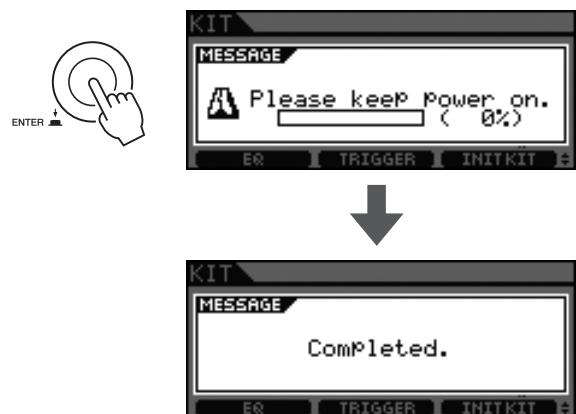

Adjusting Tone

Your DTX700 makes it very easy to adjust the tone of drum kits.



● Selecting EQ presets

The EQ presets on your DTX700 can be used to optimize the tone of the drum kits in order to suit your own personal preferences. Simply choose different equalizer presets as described below to see how they change your drum sounds.

NOTE

- For a full list of DTX700 EQ presets, see the *Data List* document.

1 Press the [KIT] button.



2 Press the [F1] button.

The Master EQ page will open.



3 Turn the dial to choose an EQ setup.

Playing your DTX700's pads as you turn the dial makes it easier to notice the differences in tone.

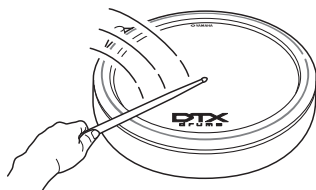

4 When you have found an EQ setup you like, press the [EXIT] button to return to the Kit page.



5 Press the [STORE] button.



If you do not wish to store your setting, press the [EXIT] button to return to the previous page.

6 Press the dial to store your new setting.



NOTE

- Changing kits has no effect on the EQ setting selected here.

Turning Off Effects

Each kit on the DTX700 is set up with reverb or another sound effect applied by default. You can, however, easily turn off this effect as described below.

1 Press the [KIT] button.



2 Hold down the [SHIFT] button and press the [F2] button.

The button's **EFFECT-ON** icon will become reversed (**EFFECT-OFF**), indicating that the effect is now off.

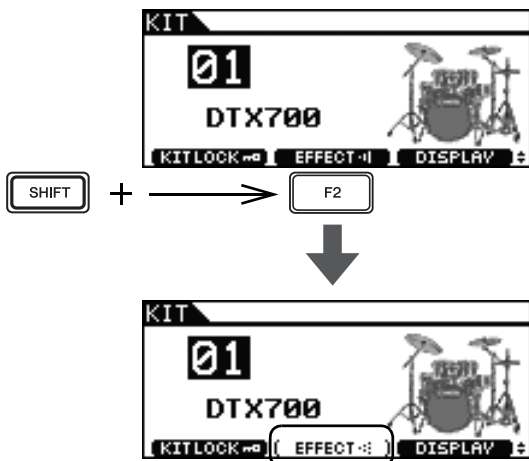

NOTE

- You can toggle the effect on and off using the method described in Step 2 above.

Initializing a Kit

By initializing a kit as described below, you can quickly restore its default settings.

1 Press the [KIT] button.



2 Turn the dial to select the kit you wish to initialize.



3 Press the [F3] button.



If you do not wish to initialize the kit, press the [EXIT] button to return to the previous page.

4 Press the dial to confirm that the kit is to be initialized.

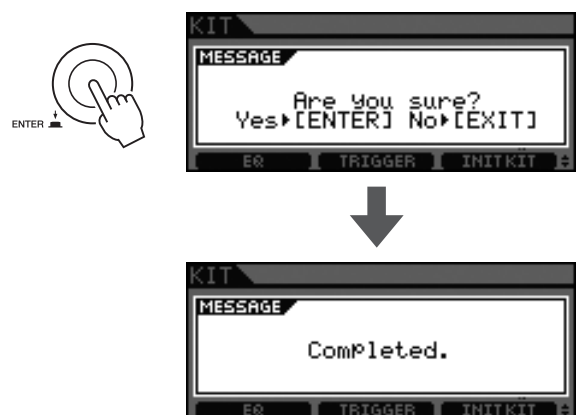

5 Press the [STORE] button.



If you do not wish to store your settings, press the [EXIT] button to return to the previous page.

6 Press the dial to store your new settings.

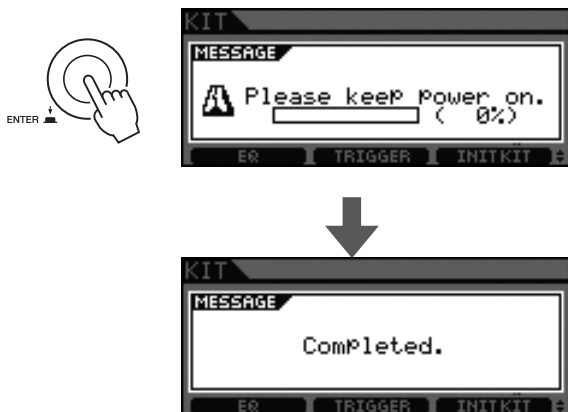

Switching the Display Mode

Normally, your DTX700's display shows the name of the kit and an artist's impression of what it might look like. As described below, however, you can change the display mode to show just the kit name.

1 Press the [KIT] button.



2 Hold down the [SHIFT] button and press the [F3] button (Display).

The display mode will now change to show just the kit name.

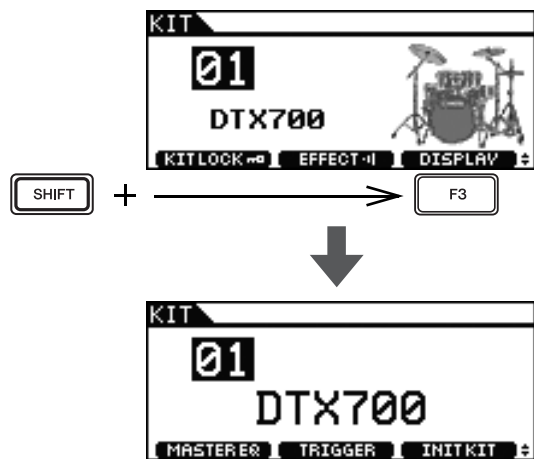

NOTE

- If you wish to return to the original display mode, hold down the [SHIFT] button and press the [F3] button (Display) once again.

Building Your Own Kit

With the DTX700, you can assign a different sound to each of the connected pads. And once you have assembled all of the sounds you wish to use, you can store them together. The following describes how to perform these operations.

Selecting Sounds (Instruments)

[Definition] Instrument

In the context of the DTX700, the term “instrument” is used to refer to each of the various percussion instruments that make up a kit. Typical examples would be snare drums, tom-toms, cymbals, and kick drums.

1 Press the [KIT] button.



2 Turn the dial to choose the kit you wish to edit.



3 Press the [INST] button.



4 Hit the pad that you wish to assign a new sound to.

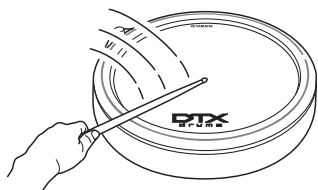

5 Turn the dial to select the sound you wish to use.

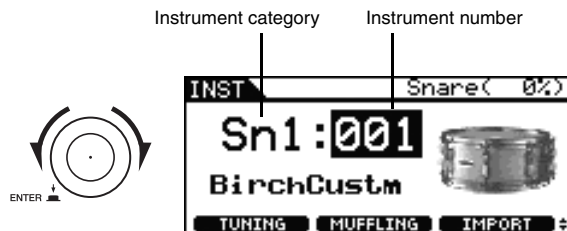

NOTE

- You can use instrument categories and numbers to find more information on different instruments in the *Data List* booklet that came with your DTX700.

6 When you have found a sound you like, press the [STORE] button.



If you do not wish to store your new setting, press the [EXIT] button. The display will return to the previous page.

7 Press the dial to store your new setting.

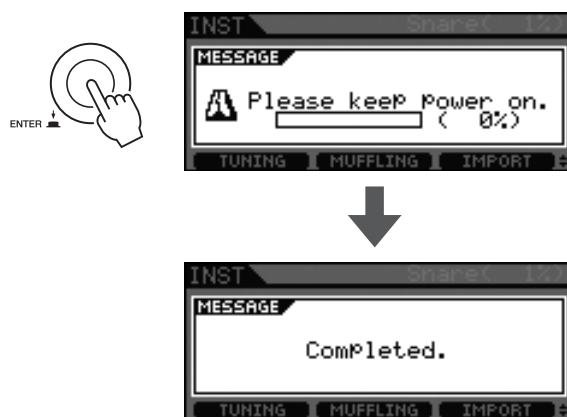

NOTE

- Even if you have changed a kit's sounds and stored your new settings, you can perform kit initialization (page 28) at any time to restore the original ones.

Adjusting an Instrument's Sound

1 Press the [KIT] button.



2 Turn the dial to choose the kit you wish to edit.



3 Press the [INST] button.



4 Hit the pad whose sound you wish to adjust.

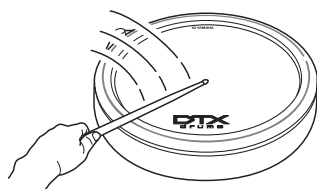

5 Press the [F1] or [F2] button.

The functions displayed at this time depend on the type of instrument selected.

Each of these functions is described in the following table.

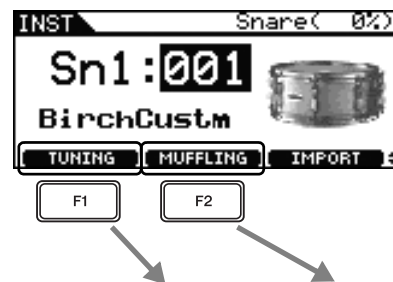

Instrument category	[F1]	[F2]
Kick (kick drums)	TUNING	MUFLING
Sn1 (snare 1)		
Sn2 (snare 2)		
Tom1 (toms 1)		
Tom2 (toms 2)		
Cym (cymbals)	SIZE	SUSTAIN
HH (hi-hats)	SIZE	CLUTCH
Latn (Latin percussion)	TUNING	DECAY
Asia (Asian percussion)		
AfAr (African percussion)		
Orch (orchestral percussion)		
EIPc (electronic percussion)		
EFX (effect sounds)		
Mldy (melodic voices)		
Wave (audio files)		

Functions

- **Tuning:** This function allows the drum to be tuned.
- **Size:** This function allows the size (or diameter) to be changed for cymbals.
- **Muffling:** This function adjusts the degree to which a drum's sound is muffled.
- **Sustain:** This function allows the amount of sustain to be adjusted.
- **Clutch:** This function adjusts the height of the hi-hat clutch – or in other words, the height of the top hi-hat.
- **Decay:** This function allows the amount of decay to be adjusted.

6 Turn the dial to adjust the sound.



7 When you have finished adjusting the sound, press the [STORE] button.



If you do not wish to store your new setting, press the [EXIT] button. The display will return to the previous page.

8 Press the dial to store your new setting.

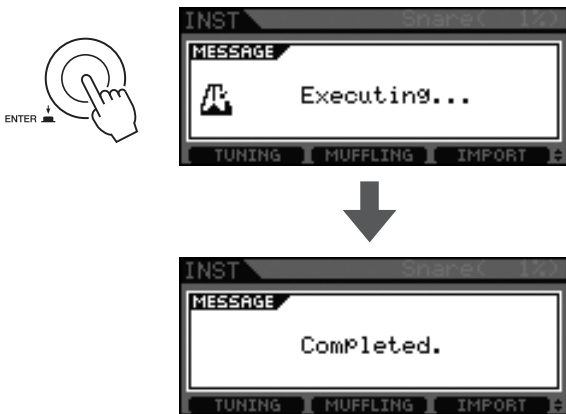

NOTE

- Even if you have adjusted a kit's sounds and stored your new settings, you can perform kit initialization (page 28) at any time to restore the original ones.

Playing with a Double Bass Drum

As described below, you can easily configure your DTX700 to produce a kick drum sound when you operate the hi-hat controller (RHH135 or HH65) plugged into the [HI-HAT CONTROL] trigger input jack. This convenient function provides support for double bass drumming techniques.

1 Press the [KIT] button and turn the dial to choose a kit.

2 Press the [INST] button and then press down once on the pedal connected to the [KICK/] trigger input jack.

The message "Kick" will be shown in the top right corner of the display.

3 Hold down the [SHIFT] button and press the [F2] (DBL BASS) button.



NOTE

- While this function is enabled, you will be unable to use the hi-hat controller plugged into the [HI-HAT CONTROL] trigger input jack to simulate opening and closing of the hi-hat.

Importing & Assigning Audio Files

1 Using a computer, place the audio files you wish to import on a USB memory device.

NOTE

- Be sure to place the audio files in the USB memory device's root directory (that is, not within any folder).
- Your DTX700 can import WAV and AIFF audio files.
- Only 16-bit audio files can be used with your DTX700.
- If the audio files you wish to use have been recorded with a different bit depth, please convert them to 16-bit in advance using, for example, the bundled DAW software. For details regarding the conversion method, please refer to the instruction manual that came with your software.
- Your DTX700 can import audio files of up to approximately 23 seconds in length (in the case of 44.1-kHz, 16-bit audio).
- Even when the above conditions have been satisfied, certain other factors may make audio files incompatible with the DTX700.

2 Unplug the USB memory device from your computer and plug it into the [USB TO DEVICE] port on the DTX700.

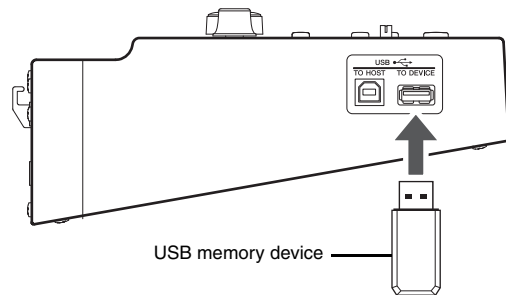

3 Press the [KIT] button.



4 Turn the dial to choose the kit you wish to edit.



5 Press the [INST] button.



- 6** Hit the pad that you wish to assign an audio file to.

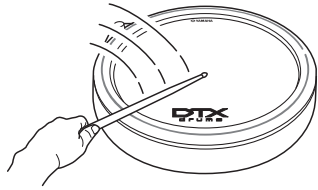

NOTE

- If the pad in question is a two- or three-zone type, the audio file will be assigned to all of its zones.

- 7** Press the [F3] button.



- 8** Turn the dial to select the audio file you wish to import.



- 9** Press the [F3] button.



To cancel the importing of an audio file, press the [EXIT] button. The display will return to the previous page.

- 10** Press the dial to start the importing process.

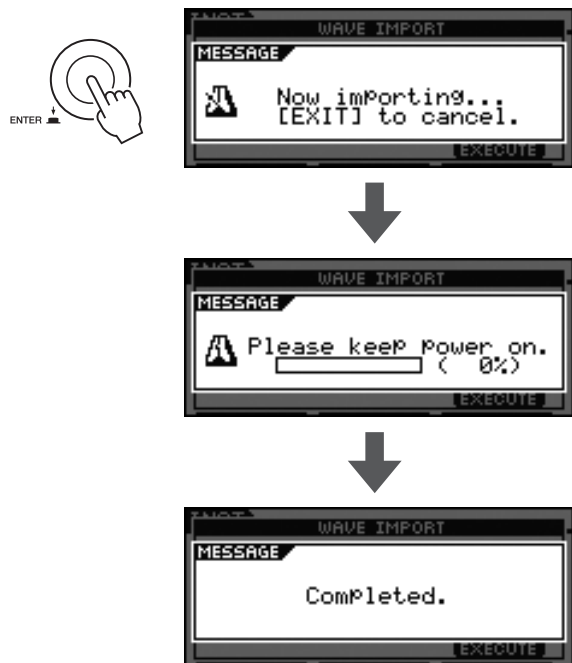

NOTE

- Whenever you import an audio file, your DTX700 will automatically store it.

Naming an Original Kit

1 Press the [KIT] button.



2 Turn the dial to choose a kit that you have built.



3 Press the [MENU] button.

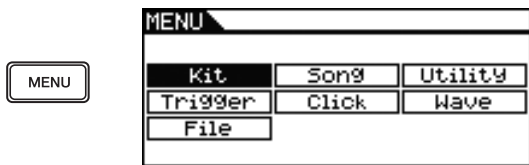

4 Turn the dial to move the cursor to "Kit".

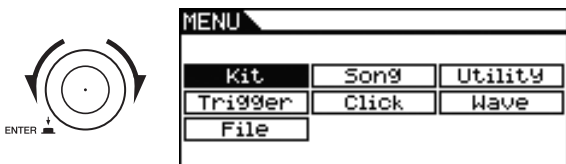

5 Press the dial.

6 Turn the dial to move the cursor to "Common".

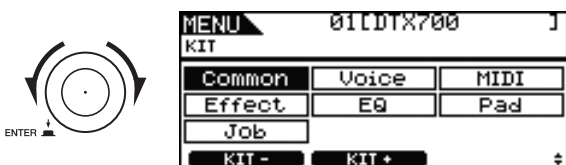

7 Press the dial.

8 Turn the dial to move the cursor to the "Name" row of the displayed list.



9 Press the dial.

10 Enter a new name for the selected kit.

A name of up to 12 characters in length can be assigned to drum kits. Move the underline cursor to the character you wish to change using the [F1] and [F3] buttons, and then use either the dial or the [+INC] and [-DEC] buttons to change the character.



11 When you have finished entering the name, press the [STORE] button.



If you do not wish to store your new kit name, press the [EXIT] button. The display will return to the previous page.

12 Press the dial to store your new kit name.



Adjusting the Snare Wire

With the DTX700, you can easily adjust the snare wire for the snare pad (i.e., the pad plugged into the [●SNARE] trigger input jack). In the case of pads featuring a pad controller, simply turn the controller to adjust the snare wire setting.

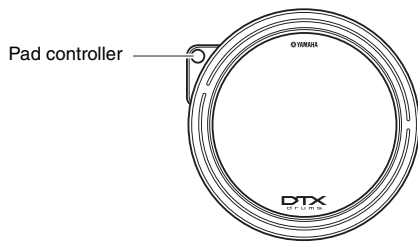

Meanwhile, the following procedure can be used to adjust the setting for pads not featuring a pad controller.

1 Press the [KIT] button.



2 Turn the dial to choose a kit.



3 Press the [INST] button.



4 Hit the snare pad (i.e., the pad plugged into the [●SNARE] trigger input jack).

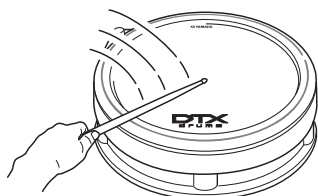

5 Hold down the [SHIFT] button and press the [F2] button.



6 Turn the dial to adjust the snare wire.

Higher values correspond to tighter snare wires and vice-versa. An "off" setting implies that the snare wire has been fully removed from the snare.



7 Press the [STORE] button.



8 Press the dial to store your new setting.



NOTE

- The Snares function is displayed only for the pad connected via the [●SNARE] trigger input jack.

Playing with Songs for Practice

Playing a Song

- 1 Press the [SONG] button.



- 2 Turn the dial to select the song you wish to play.



- 3 Press the [F3] button to start playing the song.

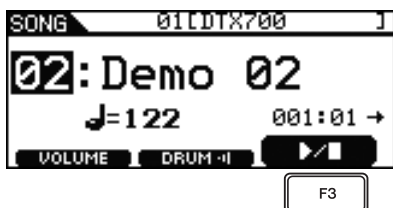

You can stop playback by pressing the [F3] button once again.

Adjusting the Song Volume

- 1 Press the [SONG] button.



- 2 Press the [F1] button.

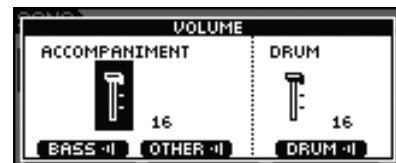

- 3 Turn the dial to adjust the song's playback volume.



- 4 Press the [EXIT] button to return to the Song page, and then press the [F3] button to start the song.

If the volume is not yet correct, repeat the above process.



Adjusting the Volume of a Song's Drums

Using the procedure described below, you can conveniently adjust the volume of a song's drum part while leaving the other parts unchanged. This function is very useful when you wish to play along with a song, keeping its drum part only slightly audible.

1 Press the [SONG] button.



2 Press the [F1] button.

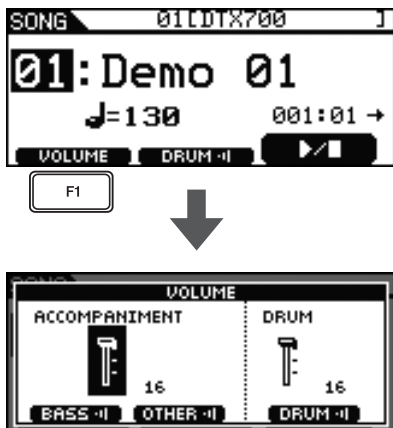

3 Press the dial to switch to the outline cursor.



4 Turn the dial to move the cursor to the DRUM fader, and then press the dial.

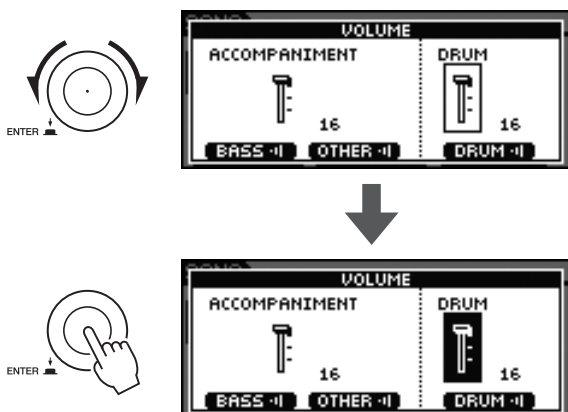

5 Turn the dial to adjust the volume.



6 Press the [EXIT] button to return to the Song page, and then press the [F3] button to start the song.

If the volume is not yet correct, repeat the above process.

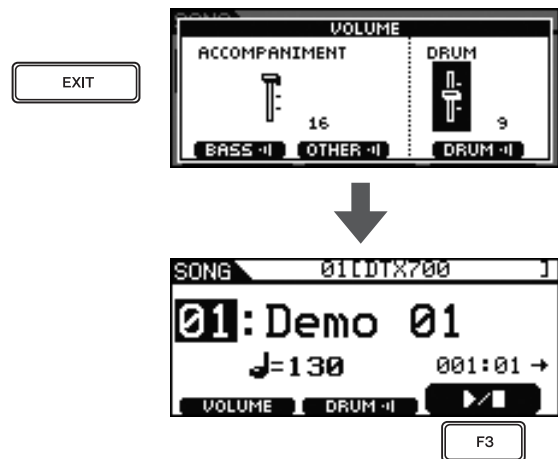

Muting the Drum Part

Using the procedure described below, you can conveniently mute (i.e., silence) a song's drum part while leaving the other parts unchanged. This function is very useful when you wish to drum along with a song.

1 Press the [SONG] button.



2 Press the [F2] button.

The **DRUM** icon will be displayed on-screen as inverted text (**DRUM**), indicating that the drums are now muted. You can unmute the drums and restore the icon to its original condition by pressing the [F2] button once again.

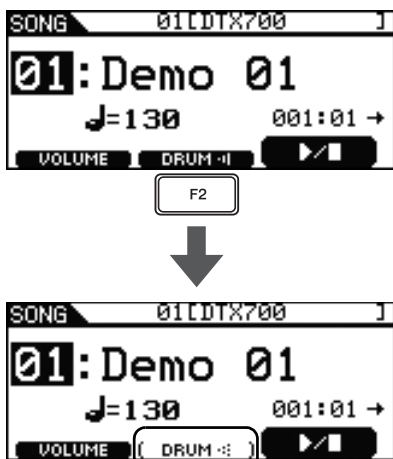

Soloing the Bass Part

Using the procedure described below, you can conveniently solo a song's bass part (i.e., silence all other parts). This function is very useful when you wish to practice with just the bass playing.

1 Press the [SONG] button.



2 Press the [F1] button.

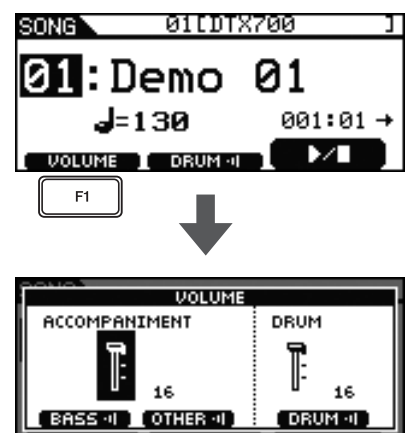

3 Press the [F2] button.

All accompaniment parts other than the bass will be muted (i.e., silenced).

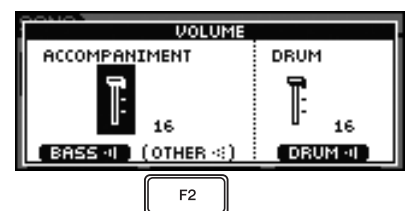

4 Press the [F3] button.

The drum part will also be muted.

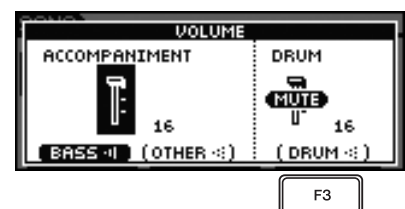

- 5** Press the [EXIT] button to return to the Song page, and then press the [F3] button to start the song.

You should now hear only the song's bass part.

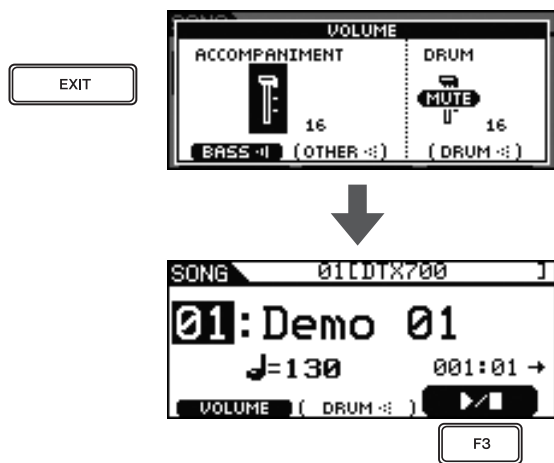

Locking a Kit

When you select a new song, your DTX700 normally chooses the best kit for that song automatically. You can, however, use the Kit Lock function to prevent this if you wish to keep the current kit when practicing with different songs.

- 1** Press the [KIT] button.



- 2** Select the kit you wish to play.



- 3** Hold down the [SHIFT] button and press the [F1] button.

The lock icon  will be displayed beside the kit number.

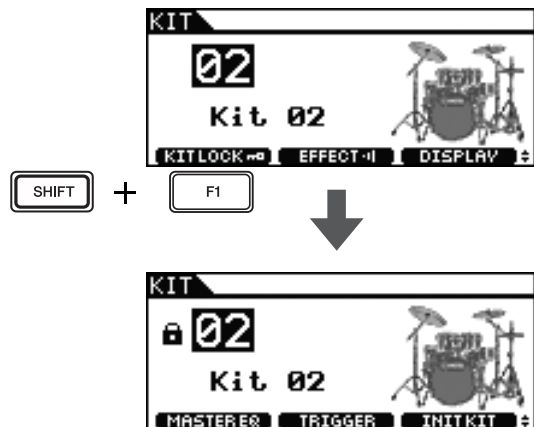

- 4** Press the [SONG] button.



5 Turn the dial to select a new song.



NOTE

- To unlock the kit, repeat Steps 1 through 3 above. After doing so, the lock icon  will disappear from beside the kit number.

Turning On the Click-Track

Setting the Tempo and Starting the Click-Track

1 Press the [CLICK] button.



2 Turn the dial to set the tempo.



3 Press the [ENTER] button.

The click-track will start playing at the selected tempo.

NOTE

- If you select a song (page 36) after setting the tempo in this way, the selected song's tempo will be used for the click-track.
- Use [MENU] → [Click] → [Voice] to change the click-track sounds. For full details, refer to the *Reference Manual* PDF document.

Setting the Click-Track Volume

● To adjust the overall click-track volume:

Move the Click slider up and down to adjust the volume.

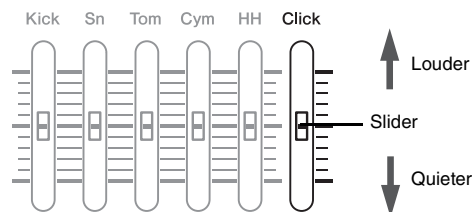

● To fine tune individual click-track volumes:

Use the following procedure to adjust the volumes of each element of the click-track.

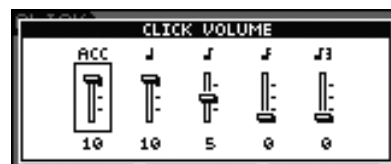

1 Press the [CLICK] button.



2 Press the [F1] button.

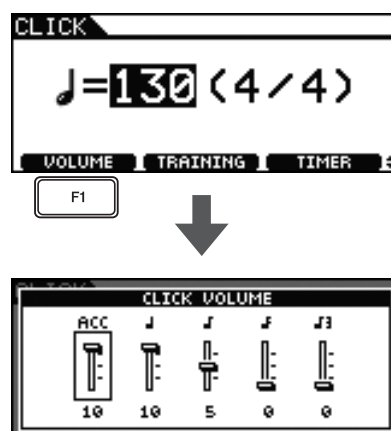

- ACC : Accent (start of measure)
- ♩ : Quarter notes
- ♪ : Eighth notes
- ♫ : Sixteenth notes
- ♫♩ : Eighth-note triplets

3 Turn the dial to select the click-track element whose volume you wish to adjust.

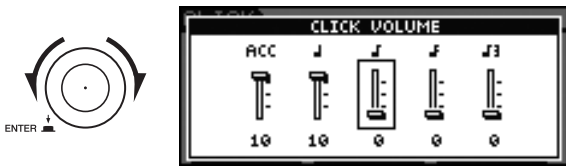

4 Press the dial.
The selected click-track element will be displayed in reverse.

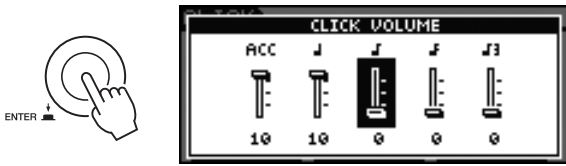

5 Turn the dial to adjust the selected element's volume.

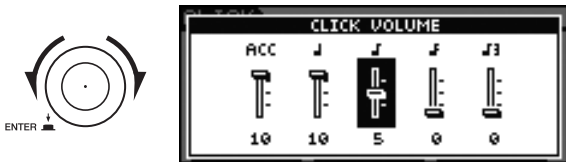

6 Press the dial.

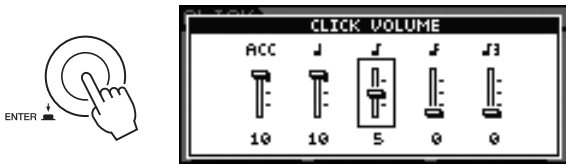

7 To adjust the volume of other elements of the click-track, repeat Steps 3 through 6 above.

8 Press the [STORE] button.



If you do not wish to store your new settings, press the [EXIT] button. The display will return to the previous page.

9 Press the dial to store your new settings.

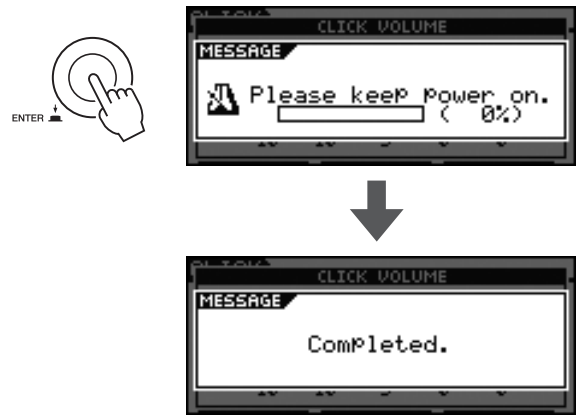

Setting the Time Signature

1 Press the [CLICK] button.



2 Press the dial.

The cursor will switch to an underline.



3 Turn the dial to move the cursor to the time signature.



4 Press the dial.

The cursor will switch to reversed text.



5 Turn the dial to set the click-track time signature.



6 Press the dial to set the new time signature.



NOTE

- If you select a song (page 36) after setting the time signature in this way, the selected song's time signature will be used for the click-track.

Using the Timer

Your DTX700's timer can be used to specify how long the click-track is to play. This function is useful when you want to practice for a set period of time.

1 Press the [CLICK] button.



2 Press the [F3] button.

Each time you press this button, the timer setting increases by 30 seconds. The longest time that can be set is 600 seconds.

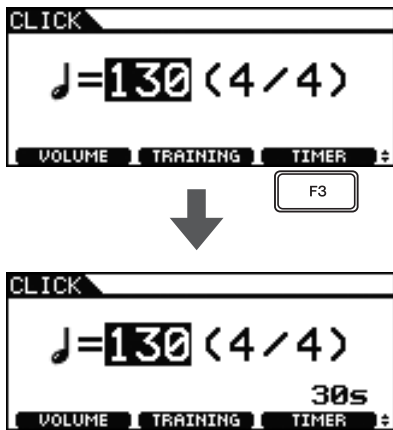

3 Press the [M] button.

The timer will now begin to count down as the click-track plays. When it reaches zero, the click-track will automatically stop playing.

NOTE

- If you press the [M] button a second time while the click-track is playing, the click-track will stop and the timer will be reset to zero.

Tap Tempo – Setting the Tempo by Playing Pads

1 Press the [CLICK] button.



2 Hold down the [SHIFT] button and press the [F1] button.



3 Hit one of your pads at least three times at the tempo you wish to set.

The new tempo will be displayed on-screen.

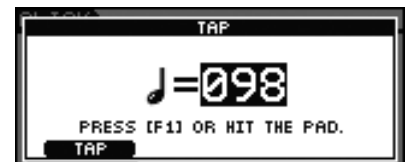
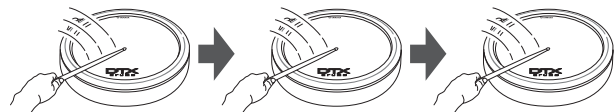

NOTE

- As an alternative to playing a pad, you can also press the [F1] button at least three times to set the tempo.
- If you select a song (page 36) after setting the tempo in this way, the selected song's tempo will be used for the click-track.

Using DTX700 Training Functions

Your DTX700 features three different types of training function.

- The Groove Check function can be used to examine your playing for inaccurate or inconsistent timing.
- The Rhythm Gate function allows you to practice playing with perfect timing.
- The Measure Break function can be used to practice playing at a constant speed.

● Groove Check – Examine inaccuracy and inconsistency in timing

The Groove Check function allows you to visually confirm how much your timing differs from that of the click-track.

1 Press the [CLICK] button.



2 Turn the dial to set the practice tempo.



3 Press the [F2] button.

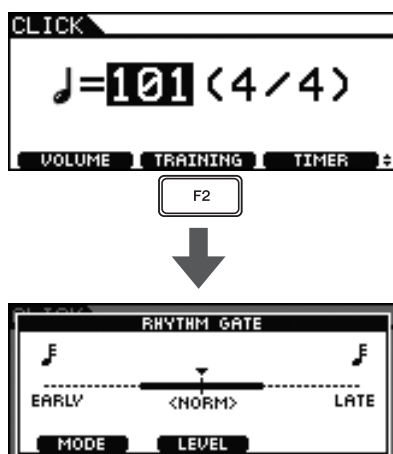

4 Press the [F1] button to access the Groove Check page. (You may need to press more than once.)



Press several times if necessary.

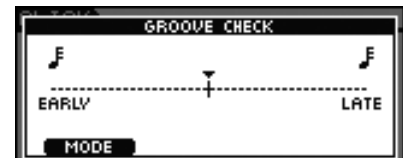

5 Press the [] button to start the click-track.

6 Play the pads along with the click-track.

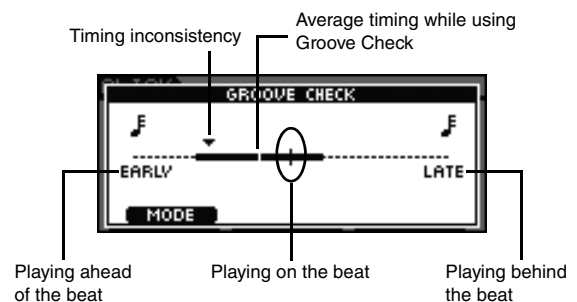

The Groove Check page

A triangle (▼) is used to display the precise time at which you played the pads.

If you are playing perfectly in time, this triangle will line up exactly with the tempo line in the center of the display.

If the triangle is located to the left of the center line, you struck the pad ahead of the beat (i.e., early).

If the triangle is located to the right of the center line, you struck the pad behind the beat (i.e., late).

The larger the timing-inconsistency bar, the greater the degree of inconsistency in your overall performance.

7 When you have finished practicing, press the [] button once again.

The click-track will stop.

● Rhythm Gate – Practice playing with perfect timing

The Rhythm Gate function only allows pads to produce a sound if they are played at exactly the right time. With this function, you can treat practice like a game, improving your ability and having fun at the same time.

1 Press the [CLICK] button.



2 Turn the dial to set the practice tempo.



3 Press the [F2] button.

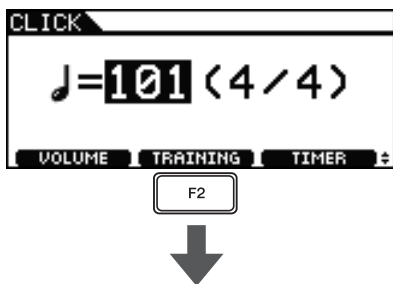

4 Press the [F1] button to access the Rhythm Gate page. (You may need to press more than once.)

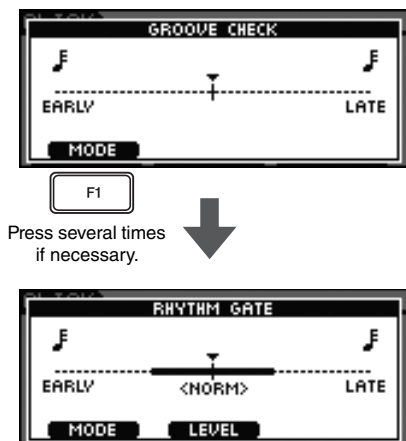

5 Press the [F2] button to select a difficulty level.

Three different levels are available – Easy, Normal, and Pro.

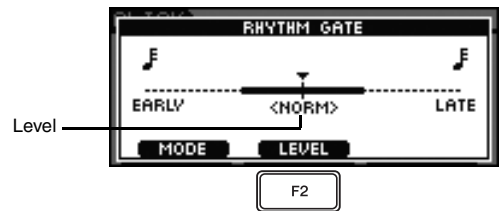

6 Press the [ENTER] button to start the click-track.

7 Play the pads along with the click-track.

Example of good timing

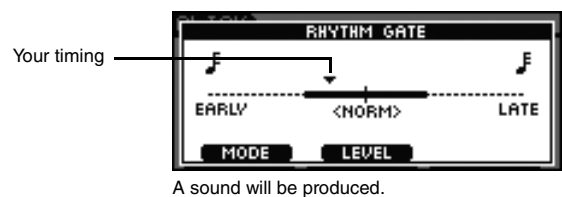

Example of poor timing

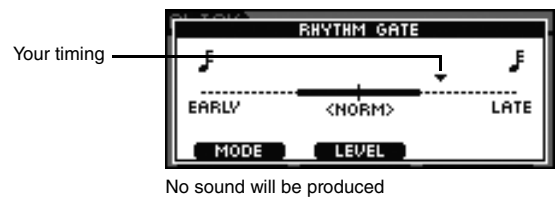

8 When you have finished practicing, press the [ENTER] button once again.

The click-track will stop.

NOTE

- You can also use the Rhythm Gate function with your DTX700's built-in songs.

● Measure Break – Practice playing a fixed rhythm

With the Measure Break function, you can automatically mute and unmute the click-track for specific numbers of measures. For example, if you were to use this function to mute the click-track while you played a fill, you would instantly know whether you played it too fast or too slow when the click-track is then unmuted. As such, the Rhythm Gate function provides a great way to practice playing complete songs at a constant speed.

1 Press the [CLICK] button.



2 Turn the dial to set the practice tempo.



3 Press the [F2] button.

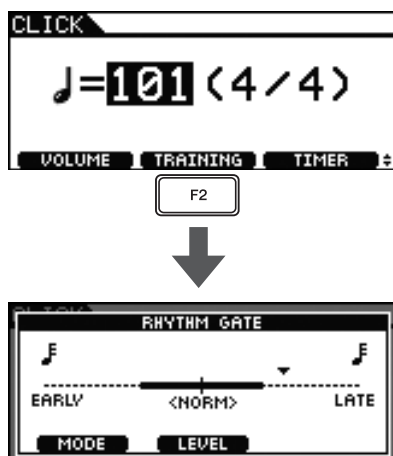

4 Press the [F1] button to access the Measure Break page. (You may need to press more than once.)

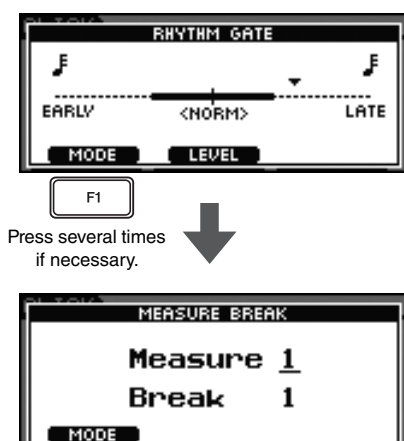

5 Set the number of measures you want the click-track to play.

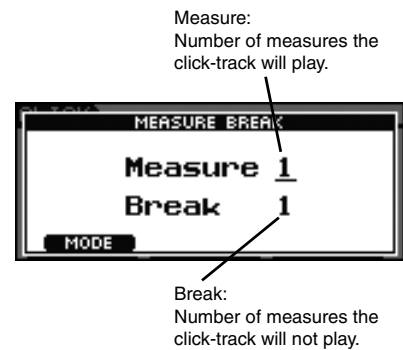

5-1 Press the dial to switch to the inverted-text cursor.

5-2 Turn the dial to set the number of measures (between 1 and 9).

5-3 Press the dial to restore the underline cursor.

6 Press the dial.



7 Set the number of measures where you want the click-track to be silent.

7-1 Press the dial to switch to the inverted-text cursor.

7-2 Turn the dial to set the number of measures (between 1 and 9).

7-3 Press the dial to restore the underline cursor.

8 Press the [] button to start the click-track.

9 Play the pads along with the click-track.

10 When you have finished practicing, press the [] button once again.

The click-track will stop.

Recording Your Performances

Recording a Performance

You can record your own drum performances using the DTX700's built-in recorder. To do so, proceed as follows.

1 Press the [REC] button.

The button will light in red.



2 Press the [▶/■] button to start recording.

The [▶/■] button will flash on and off in blue.



3 When you have finished playing, press the [▶/■] button once again.

The [REC] button and the [▶/■] button will both turn off.

NOTE

- The built-in recorder does not store your performances as audio files.
- Recording cannot be started while the DTX700 is importing an audio file or exchanging audio data with a USB memory device. Accordingly, the [REC] button will not light up at this time.
- Once you have recorded a performance, any subsequent recording will result in the first one being overwritten.

Playing a Recorded Performance

1 Press the [▶/■] button.



2 To stop playback, press the [▶/■] button once again.

NOTE

- You cannot record audio data from the [AUX IN] port on your DTX700.
- If you start playback of recorded data while playing a song, the song will stop playing. Similarly, if you start playback of a song while playing recorded data, the playback of recorded data will stop.

Deleting a Recorded Performance

1 Press the [REC] button.

The button will light in red.



2 Press the [▶/■] button.

The [▶/■] button will flash on and off in blue.



3 Press the [▶/■] button once again.

The [REC] button and the [▶/■] button will both turn off.

Recording Performance & Song Together

- 1** Press the [SONG] button.



- 2** Turn the dial to select the song you wish to play along with.



- 3** Press the [F2] button to mute that song's drum part.

The **DRUM -II** icon will switch to **DRUM -III**.

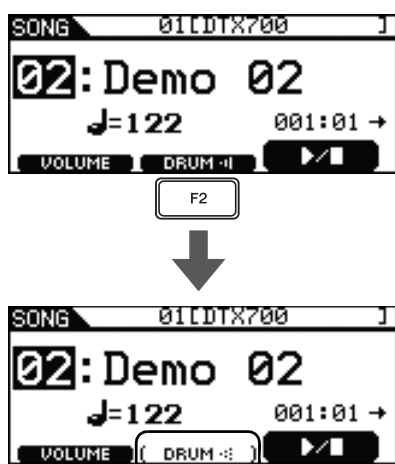

- 4** Press the [REC] button.

The [REC] button will light in red.



- 5** Press the [▶/■] button to start recording.

When the [▶/■] button starts to flash on and off in blue, you are ready to begin playing.

- 6** Press the [F3] button to start playback of the built-in song.



- 7** When you have finished playing, press the [▶/■] button once again to stop recording.

The [REC] button and the [▶/■] button will both turn off.

Integrating Accessories

As described below, you can attach various accessories* to your DTX700 for an even more enjoyable playing experience.
(*: Sold separately)

Using an HH65 Hi-hat Controller as Kick Drum Pedal

If you own an HH65 Hi-hat Controller (sold separately), you can connect it to your DTX700's [⑫HH-KICK] trigger input jack in order to play kick drum sounds. To do so, proceed as follows.

1 Turn off your DTX700.

The HH65 Hi-hat Controller must be connected with the drum trigger module turned off.

2 Insert one end of the cable that came with your HH65 into the hi-hat controller's output jack.

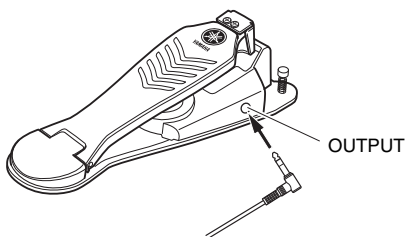

3 Insert the other end of the cable into your DTX700's [⑫HH-KICK] trigger input jack.

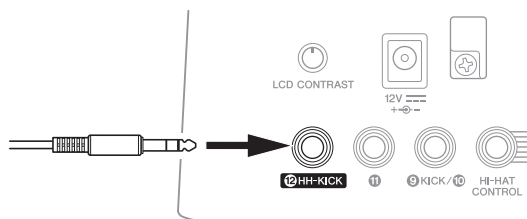

4 Turn on your DTX700.

5 Select a kit and start to play.

Expanding with a PCY135 Cymbal Pad

The following describes how to expand your DTX700 with a PCY135 Cymbal Pad (sold separately).

1 Mount your PCY135 Cymbal Pad on a cymbal holder (sold separately) or the like and set it up as part of your drum set.

2 Use the cable that came with your PCY135 Cymbal Pad to connect it to your DTX700. For demonstration purposes, we will use jack ⑪.

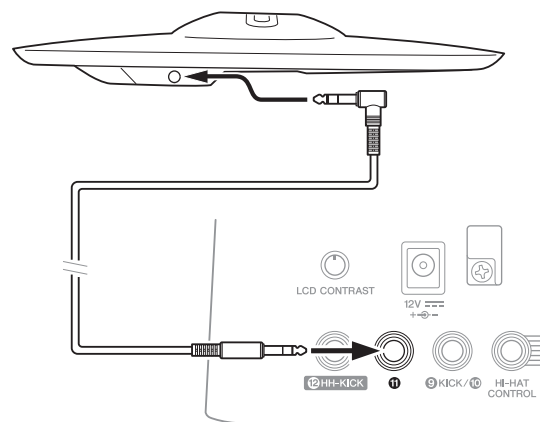

3 Turn on your DTX700.

4 Hit the newly-added cymbal pad.

5 Select the most suitable pad type.

5-1 Press the [MENU] button.

5-2 Turn the dial to select "Trigger", and then press the dial.

5-3 Turn the dial to select "Pad", and then press the dial.

5-4 Turn the dial to move the cursor to the "PadType" row of the displayed list.

5-5 Press the dial to zoom in on the pad type. Turn the dial to select "PCY135", and then press the dial once again.

6 Press the [STORE] button to store your new setting.

If the following message is displayed, press the dial to proceed.



7 Press the [INST] button and then play the newly-added cymbal pad.

If you have connected the pad correctly, the message "Pad11" will be shown in the top right corner of the display.



8 Turn the dial to select a sound for your newly-added pad.

9 Press the [STORE] button to store the assigned sound.

If the following message is displayed, press the dial to proceed.



Connecting Your DTX700 to a Computer

Making Connections

Although the DTX700 is exceptionally powerful and versatile all by itself, connecting it to a computer via USB allows for even greater convenience and flexibility. When connected in this way, MIDI data can be freely transferred between the drum trigger module and the computer, allowing the DTX700 to be used as an input device for computer-based music software. In this section, you'll learn how to make the necessary connections.

NOTE

- As the DTX700 has no built-in speakers, you will need to connect headphones or an external amplifier and speakers in order to hear it. For details, see page 13.
- A USB cable is not included. In order to connect your DTX700 to a computer, choose a USB A-B cable of no more than 3 meters in length.

1 Using your computer, download the newest Yamaha USB-MIDI driver from the following web page.

After you click Download, select a convenient location for the installation file.

<http://dtxdrums.yamaha.com/downloads/>

NOTE

- Information on system requirements is also provided on the above web page.
- The USB-MIDI driver may be revised and updated without prior notice. Before installing, visit the above web page to confirm the latest related information and ensure that you have the most up-to-date version.

2 Install the USB MIDI driver on your computer.

For instructions on installing, refer to the guide included with the driver installer. When asked to connect your Yamaha product and your computer, do so as shown below.

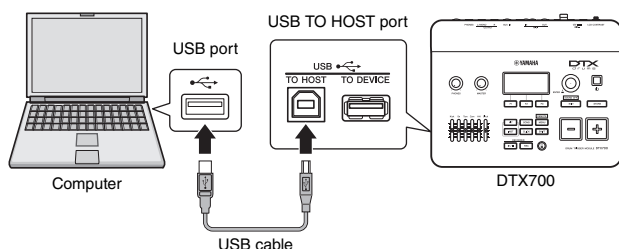

■ Precautions when using the [USB TO HOST] port

If proper care is not taken when connecting your DTX700 to a computer via the [USB TO HOST] port, either or both of the devices may freeze or data may be corrupted or permanently lost. Be sure, therefore, to observe the following precautions at this time. If your computer or DTX700 should freeze, restart the application being used, reboot the computer, or turn the drum trigger module off once and then back on.

NOTICE

- Use a USB A-B cable of no more than 3 meters in length.
- Before connecting to your computer via the [USB TO HOST] port, restore it from any power-saving mode (such as Suspend, Sleep, or Standby).
- Connect the computer via the [USB TO HOST] port before turning on the DTX700.
- Be sure to always perform the following steps before turning the DTX700 on or off and either plugging or unplugging the USB cable.
 - Quit all applications.
 - Ensure that no data is being sent from the DTX700. (Data is transmitted by striking the pads or playing patterns.)
 - When connected to a computer, allow at least 6 seconds to pass between turning the DTX700 on or off and plugging or unplugging the USB cable.

Making Music with a Computer

■ Recording Performances using a DAW Application

[Definition] DAW Application

DAW is an abbreviation of digital audio workstation. DAW applications such as Cubase can be used to record, edit, and mix audio and MIDI data on a computer.

The following section will describe how to connect your DTX700 to a computer and prepare for recording performances using a DAW application running on it. Normally, when playing in order to record on a computer, performance data produced by striking the pads is first sent to the computer and then returned to the instrument in order to play its internal tone generator. If local control of the DTX700 is turned on at this time, performance data will also be sent directly to the tone generator, and as a result, the direct and returned data will overlap, making it sound as if the pads are being struck twice.

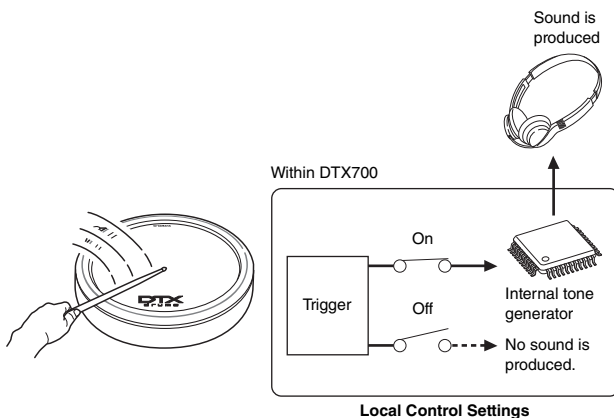

Most DAW applications allow MIDI Thru to be turned on, and therefore, you can setup your system as shown below with local control of the DTX700 turned off and the DAW application returning performance data to the tone generator. In this way, performances can be recorded in comfort without each strike being heard twice.

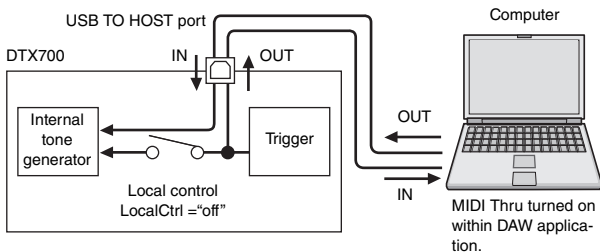

We will now describe how to setup parameters for recording your performances, first on the DTX700, and then within the DAW application.

● Preparing the DTX700

Using the following procedure, turn off DTX700 local control.

1 Use [MENU] → [Utility] → [MIDI] to access the MIDI parameters, and set LocalCtrl to "off":

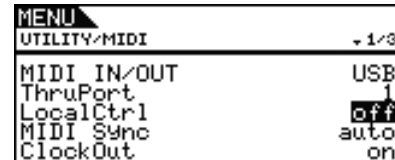

2 Press the [STORE] button to store your new setting.

With local control turned off in this way, performance data produced by striking the pads will not be sent to the internal tone generator.

● Setting DAW-Application Parameters

Within your DAW application, turn on MIDI Thru. This setting ensures that, when performance data is being recorded on a track within your application, it is also returned to the external MIDI system.

For example, let's assume that performance data is being recorded on Track 3 by your DAW application. In addition, we'll also assume that MIDI Channel 1 has been set for the return of performance data. If MIDI Thru is now turned on for Track 3, the DAW application will return the performance data to the DTX700 on MIDI Channel 1 as it is being recorded, and the instrument's internal tone generator will sound as if it is being played directly.

NOTE

- For details on how to turn on MIDI Thru, refer to the manual that came with your DAW application.
- If local control on the DTX700 and MIDI Thru within your DAW application are both turned off, no performance data will be sent to the internal tone generator, either directly or indirectly. As a result, no sound will be produced.

■ Playing the DTX700 using MIDI Data from a DAW Application

As described below, you can setup your DTX700 to operate as a multi-timbral tone generator for your DAW application. In this way, you can easily integrate the instrument's high-quality MIDI tone generator into your music-production setup. For details on how to connect the DTX700 to your computer, see page 52.

1 Set each of the tracks within your DAW application to output their MIDI data to the DTX700.

2 Play MIDI performance data using the DAW application.

Setting up Cubase Remote Control

Using a special feature, the DTX700 can operate as a remote controller for Cubase. For example, you can operate the Cubase transport, turn its metronome on or off, and control various other functions from the instrument's control panel, significantly increasing the efficiency of your music production workflow.

■ Computer settings

When setting up Cubase remote control for the first time, complete the following steps to configure your computer correctly.

1 Download the latest version of the DTX700 Extension from the following web page.

Save the compressed file in a convenient location and then expand it.

<http://dtxdrums.yamaha.com/downloads/>

NOTE

- Ensure that you have the latest USB MIDI driver installed on your computer (see page 52).
- Information on system requirements is also provided on the above web page.
- The DTX700 Extension may be revised and updated without prior notice. Before installing, visit the above web page to confirm the latest related information and ensure that you have the most up-to-date version.

2 Execute the expanded DTX700 Extension to carry out the required installation procedure.

For more details, refer to the owner's manual included in the downloaded package.

■ DTX700 settings

Whenever the Cubase Remote function is to be used, the following steps must be completed on the DTX700.

1 Use [MENU] → [Utility] → [MIDI] to access the MIDI parameters, and set MIDI IN/OUT to "USB".

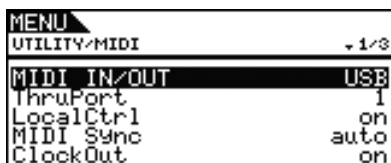

2 Ensure that the DTX700 is connected to your computer in the correct manner, and then launch Cubase.

For details on how to connect the DTX700 to your computer, see page 52.

3 Hold down the [SHIFT] button and press the [MENU] button.

The message "Cubase Remote" will be displayed to confirm that the function has been activated.



NOTE

- When Cubase Remote mode has been activated, those control-panel buttons that can be used will light up.

4 To deactivate Cubase Remote mode, again hold down the [SHIFT] button and press the [MENU] button.

■ Using remote functions

NOTE

- For details on how to use remote functions, refer to the owner's manual included in the downloaded package.

On-Screen Messages

Message	Full meaning
Are you sure?	This message is displayed to confirm whether or not you wish to proceed with the selected operation.
Completed.	This message is displayed when loading, saving, formatting, and other similar operations have been completed.
Connecting USB device...	This message is displayed when your DTX700 is busy mounting a USB memory device.
Copy protected.	This message is displayed if operations such as wave editing cannot be performed due to the digital audio source being copy protected.
Excessive demand for USB power.	This message is displayed if the current being drawn by the USB memory device exceeds the level supported by your DTX700.
Executing...	This message is displayed while your DTX700 is busy performing formatting or another similar management task. Please wait until the operation is completed.
File already exists.	This message is displayed if a file with the same name as the one you are about to save already exists.
File not found.	This message is displayed if no file of the selected type exists.
Illegal file.	This message is displayed if the file selected for loading is unsuitable for use with your DTX700 or is unsuitable for the current mode.
Illegal file name.	This message is displayed if the specified file name is not valid.
Illegal format.	This message is displayed if the standard MIDI file (SMF) you are attempting to import is of Format 1. Please select an SMF of Format 0 to proceed.
Illegal selection.	This message is displayed if an operation cannot be performed in accordance with the settings made.
Illegal wave data.	This message is displayed if the audio file you are attempting to import is of an unsupported format.
Incompatible USB device.	This message is displayed if an unsupported USB device is plugged into the instrument's [USB TO DEVICE] port.
Invalid USB device.	This message is displayed if the plugged-in USB memory device is not usable in its current condition. As long as the device contains no irreplaceable data, it should be formatted to make it usable.
MIDI buffer full.	This message is displayed if the volume of MIDI data received is too large to process.
MIDI data error.	This message is displayed if an error occurs while receiving MIDI data.
No data.	This message is displayed if you are attempting to perform a song management task even though the selected song contains no data, or if you attempt to play recorded data when none exists.
No response from USB device.	This message is displayed if the plugged-in USB memory device fails to respond.
No unused MIDI note.	This message is displayed upon execution of a copy-pad operation if no unused MIDI notes are available.
No wave data.	This message is displayed if you are attempting to perform a wave management task even though no wave data exists.
Now importing...[EXIT] to cancel.	This message is displayed while your DTX700 is busy importing wave data.
Now loading...[EXIT] to cancel.	This message is displayed while your DTX700 is busy loading a file.
Now saving... [EXIT] to cancel.	This message is displayed while your DTX700 is busy saving a file.
Now working...	This message is displayed while your DTX700 is tidying up after importing a wave or after you press the [EXIT] button to cancel a load or save operation.
Overwrite?	This message is displayed when saving files to confirm whether or not you wish to overwrite a file of the same name already present on the USB memory device.
Please keep power on.	This message is displayed while your DTX700 is writing data to its flash ROM. You should never turn off the instrument while it is in this state. If this precaution is not observed, user data may be lost or the internal system may be damaged, rendering your DTX700 unable to startup normally when it is next turned on.
Please stop sequencer.	This message is displayed to remind you to stop the sequencer (i.e., song playback) before performing the intended operation.
Read only file.	This message is displayed if you are attempting to perform a file operation using a read-only file.
Sample is protected.	This message is displayed if the selected audio file is write protected and cannot be overwritten.
Sample is too long.	This message is displayed if the audio file is too long to be loaded.
Sample is too short.	This message is displayed if the audio file is too short to be loaded.
Seq memory full.	This message is displayed if the instrument's internal memory for sequence data is full, making it impossible to record new songs, perform associated management tasks, or load data from a USB memory device. To free up some of this sequence memory, delete unneeded User patterns.
Stored.	This message is displayed to confirm that data has been successfully stored.
System memory crashed.	This message is displayed if a problem occurred while writing data to the instrument's internal flash ROM.
USB connection terminated.	This message is displayed if connection with the USB memory device was interrupted by an abnormal electric current. Unplug the USB memory device and press the dial to return.
USB device full.	This message is displayed if the USB-memory device is full and no more files can be saved on it. In such a case, use a new USB memory device or make space by erasing unwanted data from the current device.
USB device not ready.	This message is displayed if the USB memory device has not been correctly plugged into your DTX700.
USB device read/write error.	This message is displayed if an error occurred during the exchange of data with the USB memory device.
USB device write protected.	This message is displayed if the USB memory device is write protected or if you are attempting to save data on a read-only device such as a CD drive.
USB host not ready.	This message is displayed if the Cubase Remote function is turned on without first connecting the DTX700 to a computer.
USB transmission error.	This message is displayed if an error occurred during communication with the USB memory device.
Wave memory full.	This message is displayed if your DTX700's wave memory is full, preventing operations such as the importing and loading of data.

Troubleshooting

For more troubleshooting tips, refer to the *Reference Manual* PDF document.
See page 5 for details on downloading this manual.

The DTX700 either produces no sound or is unable to detect the pads being struck.	<ul style="list-style-type: none"> • Ensure that the pads are correctly connected to the DTX700's trigger input jacks. • Ensure that the DTX700 is properly connected to headphones or an external audio system, such as an amplifier and/or speakers. (See page 13.) • Ensure that the amplifier and/or speakers connected to the DTX700 are turned on and are not set to the lowest possible volume. • Ensure that the [MASTER] knob is not turned down. (See page 19.) • Ensure that the cables you are using are in good condition.
The DTX700 produces sound but the sensitivity (i.e., volume) is too low.	<ul style="list-style-type: none"> • If any of your pads feature a pad controller, ensure that they are turned up. • Ensure that the sliders for the sounds in question are turned up. (See page 11.)
Double triggers are being produced.	If the pad in question features a pad controller, try turning it downward.
The DTX700 receives no switch or trigger signals whatsoever.	Restore the default settings (i.e., the Factory Set). (See page 22.)
Sounds play endlessly and do not stop.	Hold down the [SHIFT] button and press the [EXIT] button to silence all sounds.
The pad controller function does not work as expected.	Ensure that you are using an XP100SD or another pad featuring a pad controller.
The hi-hat's open and closed sounds are not produced.	Ensure that the DBL BASS parameter is not turned on. (See page 32.)
The Factory Set (i.e., default settings) needs to be restored.	See the instructions on page 22. They describe how to reset all internal DTX700 settings to their default condition.
The DTX700 turns off unexpectedly.	Ensure that the Auto Power-Off function is not turned on. (See page 14.)
The Factory Set (i.e., default settings) is restored whenever the DTX700 is turned on.	Turn off the PowerOn Auto function. (See page 22.)
The kit changes whenever a new song is selected.	By default, your DTX700 always chooses the best kit for each song. To prevent it from doing so, turn on the Kit Lock function. (See page 39.)
Song parts (i.e., non-drum parts) do not play.	Ensure that the accompaniment parts have not been muted. (See page 37.)
The click-track (or metronome) does not play. Certain sounds (such as snare or kick) do not play.	Ensure that the sliders for the sounds in question are turned up. (See page 41.)
Drum kits cannot be changed by turning the dial.	Ensure that the Kit Lock function is not turned on. (See page 39.)
Performances cannot be recorded.	Recording is not possible while the Menu area is being accessed (as a result of pressing the [MENU] button). Ensure that you leave this area before attempting to record a performance.
Hi-hat closed sounds are not produced.	Refer to the <i>Reference Manual</i> PDF document.
Cubase Remote mode cannot be deactivated.	See page 54 of this booklet.







Specifications

Tone generator	Type	AWM2
	Maximum polyphony	64 notes
	Audio data memory	100 MB (16-bit linear basis)
	Voices	Drum and percussion: 1268 Keyboard: 128
	Drum kits	60 (all of which may be edited and overwritten) * Includes 50 preset kits
	Effects	Variation: 42 types / Chorus: 6 types / Reverb: 6 types Kit EQ: 4 band / Master EQ: 3 band
Trigger	Trigger setups	20 (all of which may be edited and overwritten) * Includes 9 preset trigger setups
	Pad Song	play, chase, cutoff 3 songs (max.) can be played simultaneously.
Audio files	Import limit	500 files
	Bit depth	16 bits
	Audio-file memory	64 MB
	Sample format	Proprietary format, WAV, and AIFF
Sequencer	Capacity	152000 sounds approx.
	Note resolution	480 per quarter note
	Recording method	Real time replace
	Songs	93 (all of which may be edited and overwritten) * Includes 63 preset songs (2 demo songs / 44 practice songs / 17 pad songs)
	Sequence format	Proprietary SMF format 0 (load only)
Click-track	Tempo	30 to 300 BPM, tap tempo supported.
	Time signatures	1/4 to 16/4, 1/8 to 16/8, 1/16 to 16/16
	Elements	Accents, quarter notes, eighth notes, sixteenth notes, and triplets
Other	Display	160 x 64 dot matrix LCD (with backlight)
	Jacks and terminals	Trigger input jacks 1 to 11 (standard stereo audio) [HI HAT CONTROL] jack (standard stereo audio) [HH-KICK] jack (standard stereo audio) OUTPUT [L/MONO] jack (standard mono audio) OUTPUT [R] jack (standard mono audio) [PHONES] jack (standard stereo audio) [AUX IN] jack (mini stereo audio) MIDI [IN] and [OUT] connectors [USB TO HOST], [USB TO DEVICE] ports DC IN
	Power consumption	8 W
	Dimensions and weight	277 x 213 x 95 mm, 1.5 kg
	Package contents	Bundled power adaptor (PA-150 or equivalent), Owner's Manual (this document), Data List, module holder, module-holder fixing screws x 4, DVD (for bundled software)

* Specifications and descriptions in this owner's manual are for information purposes only. Yamaha Corporation reserves the right to modify products or specifications at any time without prior notice. Since specifications, equipment, and options may not be the same in every locale, please check with your Yamaha dealer.

Index

Symbols

[12V  + ] connector 12, 13
[] button 11, 41
 (Standby/On) button 10, 13, 14
[-/DEC] button 11, 18
[+/INC] button 11, 18
[ / ] button 11, 48
[AUX IN] (auxiliary input) jack 12, 13
[CLICK] button 11, 41
[EXIT] button 10
[HI-HAT CONTROL] jack 12, 32
[INST] button 11, 30
[KIT] button 10, 25
[LCD CONTRAST] knob 12, 19
[MASTER] knob 10, 14, 19
[MENU] button 11, 20
[MIDI IN] input connector 12, 13
[MIDI OUT] output connector 12, 13
OUTPUT [L/MONO] and [R] jacks 12, 13
[PHONES] jack 12, 13
[PHONES] knob 10, 13, 19
[REC] button 11, 48
[SHIFT] button 11, 18
[SONG] button 11, 36
[STORE] button 10, 21
[USB TO DEVICE] port 11, 21
[USB TO HOST] port 11, 52

A

ACC (accent) 41
Accompaniment 37
AfAr (African percussion) 31
All Sound Off 10, 56
Asia (Asian percussion) 31
Audio effects 28
Audio Files 32
Auto Power-Off 14, 56

B

Bass soloing 38
Beat 43
Bell shot 24
Bow shot 24
Built-in recorder 48
Built-in song 8, 16

C

Category 30
Choking 24
Click-Track 41
Close 23
Closed rim shot 23
Clutch 31
Contrast adjustment 19
Control panel 10
Cord clip 12, 13
Cubase 54
Cubase remote 54
Cursor 17
Cym (cymbals) 31
Cymbal 24, 50

D

Data list 5, 27, 30
DAW application 53

DBL BASS 32
Decay 31
Dial (with integrated button) 10, 17
Display (function) 29
Display (LCD) 10, 19, 29
Display mode 18, 29
Double bass drum 12, 32

E

Edge shot 23, 24
Effect 28
Effects Switch 18
EFX (effect sounds) 31
Eighth note 41
Eighth-note triplet 41
EIPc (electronic percussion) 31
Equalization 27
External audio devices 12, 13

F

Factory Set 22, 56
Function 10, 18

G

Groove check 45

H

Head shot 23
HH (hi-hats) 31
Hi-Hat 23
Hi-hat controller 12, 32, 50
Hi-hat splash 23

I

Init kit 28
Initializing a kit 28, 30, 32
Instruments 8, 11, 30
Inverted display 17

K

Kick (kick drums) 31
Kit 10, 25
Kit Lock 18, 39

L

Latn (Latin percussion) 31
Line-level output 12, 13
Local control 53
LocalCtrl 53

M

Master EQ 27
Measure break 45, 47
Menu 5, 20, 59
Metronome 9, 11, 41
Mldy (melodic voices) 31
Monitor system 13
Muffling 31
Mute 38, 56
Muting 24

O

Open 23
Open rim shot 23
Orch (orchestral percussion) 31

P

Pad controller 35
Pad expansion 50
Play 36
Portable music player 12, 13
Power adaptor 13
PowerOn Auto 15, 22
Preset EQ 27

Q

Quarter note 41

R

Recording 9, 48
Recording performances 11, 48
Reference manual 5, 20, 59
Remote 54
Reverb 28
Rhythm gate 45, 46

S

Sensitivity 26, 56
Side panel 11
Sixteenth note 41
Size 31
Slider 11, 41
Sn1 (snare 1) 31
Sn2 (snare 2) 31
Snare 23, 35
Snare wire 35
Snare (function) 35
Song 36
Speakers 13
Store 10, 21
Sustain 31

T

Tap 44
Tap Tempo 44
Tempo 9, 41
Timer 44
Tom 23
Tom1 (toms 1) 31
Tom2 (toms 2) 31
Training functions 45
Trigger 26
Trigger input jack 12, 32, 50
Trigger setup 26
Tuning 31

U

Underlined display 17
USB memory device 11, 21, 32
USB-MIDI driver 52

V

Volume 19, 36, 41

W

Wave (audio files) 31

Z

Zone 12, 23, 33

MENU	→	Kit
Pad		
└ PadCtrlType		Pad Control Type
└ HH Func		Hi-hat Function
└ HH MIDI Ch		Hi-hat MIDI Channel
└ HH MIDI Type		Hi-hat MIDI Type
└ SnareOn/Off		Snare On/Off
└ SnaresAdjust		Snare Adjust
└ SnareBuzz		Snare Buzz
└ ResonanceLevel		Resonance Level
Job		
└ CopyPad		
└ Pad1		Copy Pad (Pad to be copied)
└ Pad2		Copy Pad (Pad to be replaced)
└ CopyKit		
└ Bank		Copy Kit(Bank)
└ Number		Copy Kit(Number)
└ ExchgPad		
└ Pad1		Exchange Pads
└ Pad2		
└ ExchgKit		
└ Kit1		Exchange Kits
└ Kit2		
└ ClearPad		
└ Pad		Clear Pad
└ ClearKit		Clear Kit

MENU	→	Song
Common		
└ Loop		Song Loop
└ Tempo		Song Tempo
└ Name		Song Name
MIDI		
└ Transmit		MIDI Transmit
└ Volume		MIDI Volume
└ Pan		MIDI Pan
└ MSB		Bank Select MSB
└ LSB		Bank Select LSB
└ PC		Program Change
└ VarSend(Dry)		Variation Send
└ ChoSend		Chorus Send
└ RevSend		Reverb Send
Job		
└ Clear		Clear Song
└ ClearAll		Clear All Songs
└ Copy		
└ Bank		Copy Song (Bank)
└ Number		Copy Song (Number)
└ ImprtSMF		
└ SMF		Import SMF
MemInfo		Memory Information

MENU	→	Utility
General		
└ MasterVolume		Master Volume
└ MasterTune		Master Tune
└ PanDepth		Pan Depth
└ AuxOutSel		Auxiliary Output
└ PlayCount		Play Count
└ AutoPowerOff		Auto Power Off
└ LCD Mode		LCD Mode
MasterEQ		
└ LowGain		Low Gain
└ LowFreq		Low Frequency
└ LowQ		Low Q
└ LowShape		Low Shape
└ MidGain		Mid Gain
└ MidFreq		Mid Frequency
└ MidQ		Mid Q
└ HighGain		High Gain
└ HighFreq		High Frequency
└ HighQ		High Q
└ HighShape		High Shape
Pad		
└ PadFunc		Pad Function
└ CC Ch		Control Change Channel
└ CC Val		Control Change Value
└ FootClosePos		Foot Close Position
└ FootSplashSens		Foot Splash Sensitivity
└ HH-KickVelSens		HH-KICK Velocity Sensitivity
└ CymbalChokeRate		Cymbal Choke Rate
EffectSw		
└ Variation		Variation
└ Chorus		Chorus
└ Reverb		Reverb
└ SnareBuzz		Snare Buzz
└ Resonance		Resonance
MIDI		
└ MIDI IN/OUT		MIDI In/Out
└ ThruPort		MIDI Thru Port
└ LocalCtrl		Local Control
└ MIDI Sync		MIDI Sync
└ ClockOut		Clock Out
└ SeqCtrl		Sequencer Control
└ Merge		MIDI Merge
└ Rcv10ch		Channel-10 Receive
└ RcvPC		Program Change Receive
└ RcvPC10ch		Channel-10 Program Change Receive
└ PolyAfter		Polyphonic Aftertouch Status
└ SendHH		Send Hi-hat
└ DeviceNo.		Device Number
FactSet		
└ PowerOn Auto		Instrument Reset

MENU → **Trigger**

Name	
└ Name	Trigger Setup Name
Pad	
└ Curve	
└└ VelCurve	Velocity Curve
└ PadType	
└└ PadType	Pad Type
└└ Gain	Input Gain
└└ RejectTime	Reject Time
└└ MinLevel	Minimum Input Level
└└ MaxLevel	Maximum Input Level
└└ MinVelocity	Minimum Velocity
└└ MaxVelocity	Maximum Velocity
└└ WaitTime	Wait Time
└└ Head/Bow	Head/Bow
└└ OpenEdgeOffset	Open Edge Offset
└└ CloseCupOffset	Close Cup Offset
└ Sensitivity	Sensitivity
└└ Head/Bow	Head/Bow
└└ OpenEdge	Open Edge
└└ CloseCup	Close Cup
└ NoiseFiltrTbl	Noise Filter
└ CrssTalk	
└└ Level	Reject Level (All)
└└ Level	Reject Level
└└ From	
Job	
└ CopyPad	
└└ Pad1	Copy Pad
└└ Pad2	
└ CopyTrg	
└└ Bank	Copy Trigger Parameters (Bank)
└└ Number	Copy Trigger Parameters (Number)

MENU → **Click**

Voice	Click-track Voice
OutputSel	Click-track Output
MIDI In	Click-track MIDI In
MIDI Out	Click-track MIDI Out
MIDI NoteAcc	Click-track Beat Volume (Accents)
MIDI Note ↓	Click-track Beat Volume (Notes)

MENU → **Wave**

Common	
└ PlayMode	Wave Playback Mode
└ Start	Start point
└ Loop	Loop point
└ End	End point
└ Decay	Decay
└ HHCtrlSens	Hi-Hat Control Sensitivity
└ Name	Wave Name
Job	
└ Import	
└└ Wave	Import
└└ PadAssign	Pad Assign
└ ImportAll	Import All
└ Normalize	
└└ Ratio	Normalize
└ Delete	Delete
└ DeleteAll	Delete All
└ Optimize	Optimize Memory
MemInfo	Memory Information

MENU → **File**

Save	
└ Type	Save File (Type)
└ File	Save File (File)
Load	
└ Type	Load File (Type)
└ File	Load File (File)
Rename	
└ Type	Rename File (Type)
└ File	Rename File (File)
└ Name	Rename File (Name)
Delete	
└ Type	Delete File (Type)
└ File	Delete File (File)
Format	Format
MemInfo	Memory Information

Yamaha Representative Offices in Europe

AUSTRIA Yamaha Music Europe GmbH Branch Austria Schleiergasse 20, A-1100 Wien Austria Tel: +43 (0)1 602 03900 Fax: +43 (0)1 602 039051	FINLAND (For Musical Instrument) F - Musiikki OY Kaisaniemenkatu 7, PL260 00101 Helsinki, Finland Tel: +358 (0)9 618511 Fax: +358 (0)9 61851385	ICELAND (For Musical Instrument) HLJODFAERAHUSID EHF Sidumula 20 108 Reykjavik, Iceland Tel: +354 525 50 50 Fax: +354 568 65 14	LUXEMBOURG Yamaha Music Europe Branch Benelux Clarissenhof 5b NL, 4133 AB, Vianen The Netherlands Tel: +31 (0)347 358040 Fax: +31 (0)347 358060	SLOVAKIA Yamaha Music Europe GmbH Branch Austria (Central and Eastern Europe) Schleiergasse 20, A-1100 Wien Austria Tel: +43 (0)1 602 03900 Fax: +43 (0)1 602 039051
BELGIUM Yamaha Music Europe Branch Benelux Clarissenhof 5b NL, 4133 AB, Vianen The Netherlands Tel: +31 (0)347 358040 Fax: +31 (0)347 358060	(For Pro Audio) Yamaha Scandinavia AB J A Wettergrens gata 1 Västra Frölunda, Sweden (Box 300 53, 400 43 Göteborg Sweden - Postal Address) Tel: +46 (0)31 893400 Fax: +46 (0)31 454026	(For Pro Audio) Yamaha Scandinavia AB J A Wettergrens gata 1 Västra Frölunda, Sweden (Box 300 53, 400 43 Göteborg Sweden - Postal Address) Tel: +46 (0)31 893400 Fax: +46 (0)31 454026	MALTA Olimpus Music Ltd, The Emporium, Level 3, St. Louis Street Msida MSD06 Tel: +356 (0)2133 2093 Fax: +356 (0)2133 2144	SLOVENIA Yamaha Music Europe GmbH Branch Austria (Central and Eastern Europe) Schleiergasse 20, A-1100 Wien Austria Tel: +43 (0)1 602 03900 Fax: +43 (0)1 602 039051
BULGARIA Yamaha Music Europe GmbH Branch Austria (Central and Eastern Europe) Schleiergasse 20, A-1100 Wien Austria Tel: +43 (0)1 602 03900 Fax: +43 (0)1 602 039051	FRANCE Yamaha Musique France Zone d'activité de Pariest 7, rue Ambroise Croizat 77183 Croissy-Beaubourg, France (B.P. 70, 77312 Mame la Vallée Cedex 2 France-Adresse postale) Tel: +33 (0)1 64 61 4000 Fax: +33 (0)1 64 61 4079	IRELAND (REPUBLIC OF IRELAND) Yamaha Music UK Ltd, Sherbourne Drive Tilbrook, Milton Keynes MK7 8BL United Kingdom Tel: +353 (0)1 1526 2449 Fax: +44 (0) 1908 369278	NETHERLANDS Yamaha Music Europe Branch Benelux Clarissenhof 5b NL, 4133 AB, Vianen The Netherlands Tel: +31 (0)347 358040 Fax: +31 (0)347 358060	SPAIN Yamaha Música Ibérica, S.A.U. Ctra. de la Corona km.17, 200 28230 Las Rozas de Madrid, Spain Tel: +34 902 39 8888 Fax: +34 91 638 4660
CYPRUS NAKAS Music Cyprus Ltd, 31C Nikis Ave., 1086 Nicosia Tel: +357 (0)22 510 477 Fax: +357 (0)22 511 080	GERMANY Yamaha Music Europe GmbH Siemensstr 22-34 D-25462 Rellingen, B. Hamburg, Germany Tel: +49 (0)4101 3030 Fax: +49 (0)4101 303 77702	ITALY Yamaha Musica Italia s.p.a., Viale Italia 88 20020, Lainate (Milano), Italy Tel: +39 (0)2 93577 1 Fax: +39 (0)2 937 0956	NORWAY YS Oslo Liaison Office (Yamaha Scandinavia AB Filial Norway) Grini Naeringspark 1 1361 Osteras, Norway Tel: +47 67 16 77 70 Fax: +47 67 16 77 79	SWEDEN Yamaha Scandinavia AB J A Wettergrens gata 1 Västra Frölunda, Sweden (Box 300 53, 400 43 Göteborg Sweden - Postal Address) Tel: +46 (0)31 893400 Fax: +46 (0)31 454026
CZECH REPUBLIC Yamaha Music Europe GmbH Branch Austria (Central and Eastern Europe) Schleiergasse 20, A-1100 Wien Austria Tel: +43 (0)1 602 03900 Fax: +43 (0)1 602 039051	GREECE PH. Nakas S.A. Music House/Service 19 KM Leoforos Lavriou 19022 Peania / Attiki, Greece Tel: +30 (0)210 6686260 Fax: +30 (0)210 6686269	LATVIA Yamaha Music Europe GmbH Sp. z o.o. Oddział w Polsce (Branch Poland) ul. 17 Stycznia 56 PL-02-146 Warszawa Poland Tel: +48 (0)22 500 29 25 Fax: +48 (0)22 500 29 30	POLAND YAMAHA Music Europe GmbH Sp. z o.o. Oddział w Polsce ul. 17 Stycznia 56 02-146 WARSZAWA/POLSKA Tel: +48 (0)22 500 29 25 Fax: +48 (0)22 500 29 30	UNITED KINGDOM Yamaha Music UK Ltd, Sherbourne Drive Tilbrook, Milton Keynes MK7 8BL United Kingdom Tel: +44 (0) 870 4445575 Fax: +44 (0) 1908 369278
DENMARK YS Copenhagen Liaison Office (Yamaha Scandinavia AB Filial Denmark) Generatørvvej 6A, 2730 Herlev, Denmark Tel: +45 44 92 49 09 Fax: +45 44 54 47 09	HUNGARY Yamaha Music Europe GmbH Branch Austria (Central and Eastern Europe) Schleiergasse 20, A-1100 Wien Austria Tel: +43 (0)1 602 03900 Fax: +43 (0)1 602 039051	LIECHTENSTEIN Yamaha Music Europe GmbH, Rellingen, Branch Switzerland in Zurich Seefeldstrasse 94, CH-8008 Zurich, Switzerland Tel: +41 (0)44 3878080 Fax: +41 (0)44 3833918	PORTUGAL Yamaha Música Ibérica, S.A.U. Sucursal Portuguesa Rua Alfredo da Silva 2610-016 Amadora, Portugal Tel: +351 214 704 330 Fax: +351 214 718 220	ROMANIA Yamaha Music Europe GmbH Branch Austria (Central and Eastern Europe) Schleiergasse 20, A-1100 Wien Austria Tel: +43 (0)1 602 03900 Fax: +43 (0)1 602 039051
ESTONIA Yamaha Music Europe GmbH Sp. z o.o. Oddział w Polsce (Branch Poland) ul. 17 Stycznia 56 PL-02-146 Warszawa Poland Tel: +48 (0)22 500 29 25 Fax: +48 (0)22 500 29 30	LITHUANIA Yamaha Music Europe GmbH Sp. z o.o. Oddział w Polsce (Branch Poland) ul. 17 Stycznia 56 PL-02-146 Warszawa Poland Tel: +48 (0)22 500 29 25 Fax: +48 (0)22 500 29 30			

e_list_2

Important Notice: Guarantee Information for customers in European Economic Area (EEA) and Switzerland

Important Notice: Guarantee Information for customers in EEA* and Switzerland	English
For detailed guarantee information about this Yamaha product, and Pan-EEA* and Switzerland warranty service, please either visit the website address below (Printable file is available at our website) or contact the Yamaha representative office for your country (next page). * EEA: European Economic Area	
Wichtiger Hinweis: Garantie-Information für Kunden in der EWR* und der Schweiz	Deutsch
Für nähere Garantie-Information über dieses Produkt von Yamaha, sowie über den Pan-EWR*- und Schweizer Garantieservice, besuchen Sie bitte entweder die folgend angegebene Internetadresse (eine druckfähige Version befindet sich auch auf unserer Webseite), oder wenden Sie sich an den für Ihr Land zuständigen Yamaha-Vertrieb (nächste Seite). *EWR: Europäischer Wirtschaftsraum	
Remarque importante: informations de garantie pour les clients de l'EEE* et la Suisse	Français
Pour des informations plus détaillées sur la garantie de ce produit Yamaha et sur le service de garantie applicable dans l'ensemble de l'EEE ainsi qu'en Suisse, consultez notre site Web à l'adresse ci-dessous (le fichier imprimable est disponible sur notre site Web) ou contactez directement Yamaha dans votre pays de résidence (page suivante). * EEE : Espace Economique Européen	
Belangrijke mededeling: Garantie-informatie voor klanten in de EER* en Zwitserland	Nederlands
Voor gedetailleerde garantie-informatie over dit Yamaha-product en de garantieservice in heel de EER* en Zwitserland, gaat u naar de onderstaande website (u vindt een afdrukbare versie van onze website) of neemt u contact op met de vertegenwoordiging van Yamaha in uw land (volgende pagina). * EER: Europese Economische Ruimte	
Aviso importante: información sobre la garantía para los clientes del EEE* y Suiza	Español
Para una información detallada sobre este producto Yamaha y sobre el soporte de garantía en la zona EEE* y Suiza, visite la dirección web que se incluye más abajo (la versión del archivo para imprimir está disponible en nuestro sitio web) o póngase en contacto con el representante de Yamaha en su país (página siguiente). * EEE: Espacio Económico Europeo	
Aviso importante: informazioni sulla garanzia per i clienti residenti nell'EEE* e in Svizzera	Italiano
Per informazioni dettagliate sulla garanzia relativa a questo prodotto Yamaha e l'assistenza in garanzia nei paesi EEE* e in Svizzera, potete consultare il sito Web all'indirizzo riportato di seguito (è disponibile il file in formato stampabile) oppure contattare l'ufficio di rappresentanza locale della Yamaha (pagina seguente). * EEA: Area Economica Europea	
Aviso importante: informações sobre as garantias para clientes da AEE* e da Suíça	Português
Para obter uma informação pormenorizada sobre este produto da Yamaha e sobre o serviço de garantia na AEE* e na Suíça, visite o site a seguir (o arquivo para impressão está disponível no nosso site) ou entre em contato com o escritório de representação da Yamaha no seu país (próxima página). * AEE: Área Económica Europeia	
Σημαντική σημείωση: Πληροφορίες εγγύησης για τους κλιάνους στον ΕΟΧ* και Ελβετία	Ελληνικά
Για λεπτομέρειες πληροφοριών εγγύησης σχετικά με το παρόν προϊόν της Yamaha και την κλίσην εγγύησης σε όλες τις χώρες του ΕΟΧ και την Ελβετία, επισκεφτείτε την παρακάτω ιστοσελίδα (εξυπηρετούμενη μορφή είναι διαθέσιμη στην ιστοσελίδα μας) ή απευθυνθείτε στην αντιπροσωπεία της Yamaha στη χώρα σας (επόμενη σελίδα). * ΕΟΧ: Ευρωπαϊκός Οικονομικός Χώρος	
Viktigt: Garantierinformation för kunder i EES-området* och Schweiz	Svenska
För detaljerad information om denna Yamaha-produkt samt garantierinformation i hela EES-området* och Schweiz kan du antingen besöka nedanstående webbadress (en utskriftsvänlig fil finns på webbadressen) eller kontakta Yamahas officiella representant i ditt land (nästa sida). * EES: Europeiska Ekonomiska Samarbetsområdet	
Viktig merknad: Garantierinformasjon for kunder i EES* og Sveits	Norsk
Detaljert garantierinformasjon om dette Yamaha-produktet og garantierinformasjon for hele EES-området* og Sveits kan fås enten ved å besøke nettadressen nedenfor (utskriftsvennlig fil finnes på webbadressen) eller kontakte Yamahas offisielle representant i det landet der du bor (neste side). *EES: Det europeiske økonomiske samarbeidsområdet	
Vigtig oplysning: Garantioplysninger til kunder i EØ* og Schweiz	Dansk
De kan finde detaljerede garantioplysninger om dette Yamaha-produkt og den fælles garantierordning for EØ* (og Schweiz) ved at besøge det websted, der er angivet nedenfor (der findes en fil, som kan udskrives, på vores websted), eller ved at kontakte Yamahas nationale repræsentationskontor i det land, hvor De bor (næste side). * EØ: Det Europæiske Økonomiske Område	

Tärkeä ilmoitus: Takuutiedot Euroopan talousalueen (ETA*) ja Sveitsin asiakkaille	Suomi
Tämän Yamaha-tuotteen sekä ETA-alueen ja Sveitsin takuuta koskevat yksityiskohtaiset tiedot saatte aika kaksivuotisen nettiosoitteesta. (Tulostettava tiedosto saatavissa sivustollamme.) Voitte myös ottaa yhteyttä paikalliseen Yamaha-edustajaan (seuraavalla sivulla). *ETA: Euroopan talousalue	
Ważne: Warunki gwarancyjne obowiązujące w EOG* i Szwajcarii	Polski
Aby dowiedzieć się więcej na temat warunków gwarancyjnych tego produktu firmy Yamaha i serwisu gwarancyjnego w całym EOG* i Szwajcarii, należy odwiedzić wskazaną poniżej stronę internetową (plik gotowy do wydruku znajduje się na naszej stronie internetowej) lub skontaktować się z przedstawicielstwem firmy Yamaha w swoim kraju (następna strona). * EOG — Europejski Obszar Gospodarczy	
Dôležité oznámenie: Záruční informace pro zákazníky v EHS* a ve Švýcarsku	Česky
Podrobné záruční informace o tomto produktu Yamaha a záručním servisu v celém EHS* a ve Švýcarsku naleznete na níže uvedené webové adrese (soubor k tisku je dostupný na našich webových stránkách nebo se můžete obrátit na zastupení firmy Yamaha ve své zemi (další stránka). * EHS: Evropský hospodářský prostor	
Fontos figyelmeztetés: Garancia-információk az EGT* területén és Svájcban élő vásárlók számára	Magyar
A jelen Yamaha termékre vonatkozó részletes garancia-információk, valamint az EGT*-re és Svájcra kiterjedő garanciális szolgáltatás tekintetében keressék fel webhelyünket az alábbi címen (a webhelyen nyomtatható fájl is talál), vagy pedig lépjen kapcsolatba az országában működő Yamaha képviselői irodával (következő oldal). * EGT: Európai Gazdasági Térség	
Öluline märkus: Garantiteave Euroopa Majanduspiirkonna (EMP)* ja Šveitsi klientidele	Eesti keel
Täpsemate teabes saamiseks selle Yamaha toote garantii ning kogu Euroopa Majanduspiirkonna ja Šveitsi garantiteeninduse kohta, külastage palun veebisaiti alljärgneval aadressil (meie saidil on saadaval printitav fail) või pöörduge Teie regiooni Yamaha esinduse poole (järgmine lehekülg). * EMP: Euroopa Majanduspiirkond	
Svarigs paziņojums: garantijas informācija klientiem EEZ* un Šveicē	Latviešu
Lai saņemtu detalizētu garantijas informāciju par šo Yamaha produktu, kā arī garantijas apkalpošanu EEZ* un Šveicē, lūdzam apmeklēt zemāk norādīto tīmekļa vietnes adresi (tīmekļa vietnē ir pieejams drukājams fails) vai sazināties ar jūsu valsts apkalpojošo Yamaha pārstāvniecību (nākamā lappuse). * EEZ: Eiropas Ekonomikas zona	
Děmesio: Informacija dėl garantijos pirkejams EEE* ir Šveicarijoje	Lietuvių kalba
Jei reikia išsamios informacijos apie šį „Yamaha“ produktą ir jo techninę priežiūrą visoje EEE* ir Šveicarijoje, apsilankykite mūsų svetainėje toliau nurodytu adresu (svetainėje yra spausdinamas failas) arba kreipkitės į „Yamaha“ atstovybę savo šalyje (kitas puslapis). *EEE – Europos ekonominė erdvė	
Dôležité upozornenie: Informácie o záruke pre zákazníkov v EHP* a Švajčiarsku	Slovenčina
Podrobné informácie o záruke týkajúcej sa tohto produktu od spoločnosti Yamaha a garančnom servise v EHP* a Švajčiarsku nájdete na webovej stránke uvedenej nižšie (na našej webovej stránke je k dispozícii súbor na tlač) alebo sa obráťte na zástupcu spoločnosti Yamaha vo svojej krajine (nasledujúca strana). * EHP: Európsky hospodársky priestor	
Pomembno obvestilo: Informacije o garanciji za kupce v EGP* in Švici	Slovenščina
Za podrobnejše informacije o tem Yamahinem izdelku ter garancijskem servisu v celotnem EGP in Švici, obiščite spletno mesto, ki je navedeno spodaj (natiljiva datoteka je na voljo na našem spletnem mestu), ali se obrnite na Yamahinega predstavnika v svoji državi (naslednja stran). * EGP: Evropski gospodarski prostor	
Важно съобщение: Информация за гаранцията за клиенти в ЕИП* и Швейцария	Български език
За подробна информация за гаранцията за този продукт на Yamaha и гаранционното обслужване в паневропейската зона на ЕИП* и Швейцария или посрещете помощника по-долу уеб сайт (на нашия уеб сайт има файл за печат), или се свържете с представителния офис на Yamaha във вашата страна (следваща страница). * ЕИП: Европейско икономическо пространство	
Notificare importantă: Informații despre garanție pentru clienții din SEE* și Elveția	Limba română
Pentru informații detaliate privind acest produs Yamaha și serviciul de garanție Pan-SEE* și Elveția, vizitați site-ul la adresa de mai jos (fișierul imprimabil este disponibil pe site-ul nostru) sau contactați biroul reprezentanței Yamaha din țara dumneavoastră (pagina următoare). * SEE: Spațiul Economic European	

<http://europe.yamaha.com/warranty/>

URL_3

About the accessory disk

SPECIAL NOTICE

The software included in the accessory disk and the copyrights thereof are under exclusive ownership by Steinberg Media Technologies GmbH.

- Use of the software and this manual is governed by the license agreement which the purchaser fully agrees to upon breaking the seal of the software packaging. (Please read carefully the Software Licensing Agreement at the end of this manual before installing the application.)
- Copying of the software or reproduction of this manual in whole or in part by any means is expressly forbidden without the written consent of the manufacturer.
- Yamaha makes no representations or warranties with regard to the use of the software and documentation and cannot be held responsible for the results of the use of this manual and the software.
- This disk is NOT for audio/visual purpose. Do not attempt to play the disk on an audio/visual CD/DVD player. Doing so may result in irreparable damage to your player.
- Note that Yamaha does not offer technical support for the DAW software in the accessory disk.

About the DAW software in the accessory disk The accessory disk contains DAW software both for Windows and Macintosh.

NOTE

- Make sure to install DAW software under the "Administrator" account.
- In order to have continuous use of the DAW software in the accessory disk, including support and other benefits, you will need to register the software and activate your software license by starting the software while the computer is connected to the Internet. Click the "Register Now" button shown when the software is started, then fill in all required fields for registration. If you do not register the software, you will be unable to use it after a limited period of time expires.
- If you are using a Macintosh computer, double-click the "****.mpkg" file to start installation.

For information about the minimum system requirements and latest information on the software in the disk, check the web site below.

<http://www.yamahasynth.com/>

About software support

Support for the DAW software in the accessory disk is provided by Steinberg on its website at the following address.

<http://www.steinberg.net>

You can visit the Steinberg site also via the Help menu of the included DAW software. (The Help menu also includes the PDF manual and other information on the software.)

Information for Users on Collection and Disposal of Old Equipment



This symbol on the products, packaging, and/or accompanying documents means that used electrical and electronic products should not be mixed with general household waste.

For proper treatment, recovery and recycling of old products, please take them to applicable collection points, in accordance with your national legislation and the Directives 2002/96/EC.

By disposing of these products correctly, you will help to save valuable resources and prevent any potential negative effects on human health and the environment which could otherwise arise from inappropriate waste handling.

For more information about collection and recycling of old products, please contact your local municipality, your waste disposal service or the point of sale where you purchased the items.

[For business users in the European Union]

If you wish to discard electrical and electronic equipment, please contact your dealer or supplier for further information.

[Information on Disposal in other Countries outside the European Union]

This symbol is only valid in the European Union. If you wish to discard these items, please contact your local authorities or dealer and ask for the correct method of disposal.

(weee_eu)

OBSERVERA!

Apparaten kopplas inte ur växelströmskällan (nätet) så länge som den är ansluten till vägguttaget, även om själva apparaten har stängts av.

ADVARSSEL: Netspændingen til dette apparat er IKKE afbrudt, så længe netledningen sidder i en stikkontakt, som er tændt — også selvom der er slukket på apparatets afbryder.

VAROITUS: Laitteen toisiopiiriin kytketty käyttökytkin ei irroita koko laitetta verkosta.

(standby)

The name plate of this product may be found on the bottom of the unit. The serial number of this product may be found on or near the name plate. You should note this serial number in the space provided below and retain this manual as a permanent record of your purchase to aid identification in the event of theft.

Model No.

Serial No.

(bottom)

For details of products, please contact your nearest Yamaha representative or the authorized distributor listed below.

Pour plus de détails sur les produits, veuillez-vous adresser à Yamaha ou au distributeur le plus proche de vous figurant dans la liste suivante.

Die Einzelheiten zu Produkten sind bei Ihrer unten aufgeführten Niederlassung und bei Yamaha Vertragshändlern in den jeweiligen Bestimmungsländern erhältlich.

Para detalles sobre productos, contacte su tienda Yamaha más cercana o el distribuidor autorizado que se lista debajo.

NORTH AMERICA

CANADA

Yamaha Canada Music Ltd.
135 Milner Avenue, Scarborough, Ontario,
M1S 3R1, Canada
Tel: 416-298-1311

U.S.A.

Yamaha Corporation of America
6600 Orangethorpe Ave., Buena Park, Calif. 90620,
U.S.A.
Tel: 714-522-9011

CENTRAL & SOUTH AMERICA

MEXICO

Yamaha de México S.A. de C.V.
Calz. Javier Rojo Gómez #1149,
Col. Guadalupe del Moral
C.P. 09300, México, D.F., México
Tel: 55-5804-0600

BRAZIL

Yamaha Musical do Brasil Ltda.
Rua Joaquim Floriano, 913 - 4° andar, Itaim Bibi, CEP
04534-013 Sao Paulo, SP. BRAZIL
Tel: 011-3704-1377

ARGENTINA

Yamaha Music Latin America, S.A.
Sucursal de Argentina
Olga Cossetini 1553, Piso 4 Norte
Madero Este-C1107CEK
Buenos Aires, Argentina
Tel: 011-4119-7000

PANAMA AND OTHER LATIN AMERICAN COUNTRIES/ CARIBBEAN COUNTRIES

Yamaha Music Latin America, S.A.
Torre Banco General, Piso 7, Urbanización Marbella,
Calle 47 y Aquilino de la Guardia,
Ciudad de Panamá, Panamá
Tel: +507-269-5311

EUROPE

THE UNITED KINGDOM/IRELAND

Yamaha Music U.K. Ltd.
Sherbourne Drive, Tilbrook, Milton Keynes,
MK7 8BL, England
Tel: 01908-366700

GERMANY

Yamaha Music Europe GmbH
Siemensstraße 22-34, 25462 Rellingen, Germany
Tel: 04101-3030

SWITZERLAND/LIECHTENSTEIN

Yamaha Music Europe GmbH
Branch Switzerland in Zürich
Seefeldstrasse 94, 8008 Zürich, Switzerland
Tel: 01-383 3990

AUSTRIA

Yamaha Music Europe GmbH Branch Austria
Schleiergasse 20, A-1100 Wien, Austria
Tel: 01-60203900

CZECH REPUBLIC/SLOVAKIA/ HUNGARY/SLOVENIA

Yamaha Music Europe GmbH Branch Austria
Schleiergasse 20, A-1100 Wien, Austria
Tel: 01-602039025

POLAND/LITHUANIA/LATVIA/ESTONIA

Yamaha Music Europe GmbH
Branch Sp.z o.o. Oddział w Polsce
ul. 17 Stycznia 56, PL-02-146 Warszawa, Poland
Tel: 022-500-2925

THE NETHERLANDS/ BELGIUM/LUXEMBOURG

Yamaha Music Europe Branch Benelux
Clarissenhof 5-b, 4133 AB Vianen, The Netherlands
Tel: 0347-358 040

FRANCE

Yamaha Musique France
BP 70-77312 Marne-la-Vallée Cedex 2, France
Tel: 01-64-61-4000

ITALY

Yamaha Musica Italia S.P.A.
Combo Division
Viale Italia 88, 20020 Lainate (Milano), Italy
Tel: 02-935-771

SPAIN/PORTUGAL

Yamaha Música Ibérica, S.A.
Ctra. de la Coruna km. 17, 200, 28230
Las Rozas (Madrid), Spain
Tel: 91-639-8888

GREECE

Philippos Nakas S.A. The Music House
147 Skiathou Street, 112-55 Athens, Greece
Tel: 01-228 2160

SWEDEN

Yamaha Scandinavia AB
J. A. Wettergrens Gata 1, Box 30053
S-400 43 Göteborg, Sweden
Tel: 031 89 34 00

DENMARK

YS Copenhagen Liaison Office
Generatorvej 6A, DK-2730 Herlev, Denmark
Tel: 44 92 49 00

FINLAND

F-Musiikki Oy
Kluuvikatu 6, P.O. Box 260,
SF-00101 Helsinki, Finland
Tel: 09 618511

NORWAY

Norsk filial av Yamaha Scandinavia AB
Grini Næringspark 1, N-1345 Østerås, Norway
Tel: 67 16 77 70

ICELAND

Skifan HF
Skeifan 17 P.O. Box 8120, IS-128 Reykjavik, Iceland
Tel: 525 5000

RUSSIA

Yamaha Music (Russia)
Room 37, bld. 7, Kievskaya street, Moscow,
121059, Russia
Tel: 495 626 5005

OTHER EUROPEAN COUNTRIES

Yamaha Music Europe GmbH
Siemensstraße 22-34, 25462 Rellingen, Germany
Tel: +49-4101-3030

AFRICA

Yamaha Corporation,
Asia-Pacific Sales & Marketing Group
Nakazawa-cho 10-1, Naka-ku, Hamamatsu,
Japan 430-8650
Tel: +81-53-460-2313

MIDDLE EAST

TURKEY/CYPRUS

Yamaha Music Europe GmbH
Siemensstraße 22-34, 25462 Rellingen, Germany
Tel: 04101-3030

OTHER COUNTRIES

Yamaha Music Gulf FZE
LOB 16-513, P.O.Box 17328, Jubel Ali,
Dubai, United Arab Emirates
Tel: +971-4-881-5868

ASIA

THE PEOPLE'S REPUBLIC OF CHINA

Yamaha Music & Electronics (China) Co.,Ltd.
2F, Yunhedasha, 1818 Xinzha-lu, Jingan-qu,
Shanghai, China
Tel: 021-6247-2211

HONG KONG

Tom Lee Music Co., Ltd.
11/F., Silvercord Tower 1, 30 Canton Road,
Tsimshatsui, Kowloon, Hong Kong
Tel: 2737-7688

INDIA

Yamaha Music India Pvt. Ltd.
5F Ambience Corporate Tower Ambience Mall Complex
Ambience Island, NH-8, Gurgaon-122001, Haryana, India
Tel: 0124-466-5551

INDONESIA

PT. Yamaha Musik Indonesia (Distributor)
PT. Nusantara
Gedung Yamaha Music Center, Jalan Jend. Gatot Sub-
roto Kav. 4, Jakarta 12930, Indonesia
Tel: 021-520-2577

KOREA

Yamaha Music Korea Ltd.
8F, 9F, Dongsung Bldg. 158-9 Samsung-Dong, Kang-
nam-Gu, Seoul, Korea
Tel: 02-3467-3300

MALAYSIA

Yamaha Music (Malaysia) Sdn., Bhd.
Lot 8, Jalan Perbandaran, 47301 Kelana Jaya,
Petaling Jaya, Selangor, Malaysia
Tel: 03-7803900

PHILIPPINES

Yupango Music Corporation
339 Gil J. Puyat Avenue, P.O. Box 885 MCPO,
Makati, Metro Manila, Philippines
Tel: 819-7551

SINGAPORE

Yamaha Music (Asia) Pte., Ltd.
#03-11 A-Z Building
140 Paya Lebar Road, Singapore 409015
Tel: 6747-4374

TAIWAN

Yamaha KHS Music Co., Ltd.
3F, #6, Sec.2, Nan Jing E. Rd. Taipei.
Taiwan 104, R.O.C.
Tel: 02-2511-8688

THAILAND

Siam Music Yamaha Co., Ltd.
4, 6, 15 and 16th floor, Siam Motors Building,
891/1 Rama 1 Road, Wangmai,
Pathumwan, Bangkok 10330, Thailand
Tel: 02-215-2622

OTHER ASIAN COUNTRIES

Yamaha Corporation,
Asia-Pacific Sales & Marketing Group
Nakazawa-cho 10-1, Naka-ku, Hamamatsu,
Japan 430-8650
Tel: +81-53-460-2313

OCEANIA

AUSTRALIA

Yamaha Music Australia Pty. Ltd.
Level 1, 99 Queensbridge Street, Southbank,
Victoria 3006, Australia
Tel: 3-9693-5111

NEW ZEALAND

Music Works LTD
P.O.BOX 6246 Wellesley, Auckland 4680,
New Zealand
Tel: 9-634-0099

COUNTRIES AND TRUST TERRITORIES IN PACIFIC OCEAN

Yamaha Corporation,
Asia-Pacific Sales & Marketing Group
Nakazawa-cho 10-1, Naka-ku, Hamamatsu,
Japan 430-8650
Tel: +81-53-460-2313

SY55

HEAD OFFICE Yamaha Corporation, Digital Musical Instruments Division
Nakazawa-cho 10-1, Naka-ku, Hamamatsu, Japan 430-8650
Tel: +81-53-460-2432

Yamaha Electronic Drums web site
<http://dtxdrums.yamaha.com/>

Yamaha Manual Library
<http://www.yamaha.co.jp/manual/>

U.R.G., Digital Musical Instruments Division
© 2011 Yamaha Corporation

012PO***.*-01A0



WW02610