



DRUM TRIGGER MODULE

DTXPRESS

English

Français

Deutsch

Español



Owner's Manual / Reference Guide

Mode d'emploi / Guide de référence

Bedienungsanleitung / Referenzhandbuch

Manual de instrucciones / Guía de referencia



CONTENTS

How to use the Manual

The DTXPRESS Owner's Manual is divided into the following two books.

● Basic Guide

Please read this book before using the DTXPRESS.

This book contains cautions that must be followed for safe and proper use of the DTXPRESS.

Also, control and function names, connecting the pads and how to play the DTXPRESS, how to record and playback songs, how to create original drum kits are all described in this book.

At the rear of this book you will find an appendix section with specifications and error messages.

● Reference Guide (this book)

This book describes in detail each of the DTXPRESS' functions.

At the rear of this book you will find an appendix section with drum voice, song, MIDI data format, etc.

About the descriptions

This manual describes buttons and explanations using the following rules.

- [PLAY], [START/S], etc.
The button on the front panel is indicated with []. (brackets).
- [SHIFT]+[START/S], etc.
Means hold the [SHIFT] button and press the [START/S] button.
- [PAGE▲]/[PAGE▼], etc.
Means use the [PAGE▲] button or [PAGE▼] button.
- "Complete!", etc.
Words inside " " indicate the message shown on the display.
- → P. 10, etc.
Indicates the reference page where further information can be found.

NOTE

The illustrations and LCD screens as shown in this owner's manual are for instructional purposes only, and may appear somewhat different from those on your instrument.

DTXPRESS Internal Makeup	4
Drum Kit Play Mode	6
1. Drum Kit & Song	6
2. Trigger Setup & Tempo	6
3. Song & Mute	7
Groove Check Function	7
About the Song	8
Song Playback	8
Song Recording	10
Trigger Setup Edit Mode	11
1. INPUT PARAMETERS	12
1-1. Pad Type	12
1-2. Gain, Minimum Velocity	12
1-3. Velocity Curve	13
1-4. Self Rejection, Rejection	13
1-5. Specific Rejection	13
1-6. Trigger Setup Copy	13
2. COMMON PARAMETERS	14
2-1. Increment/Decrement	14
2-2. Input Exchange	14
2-3. Trigger Setup Name	14
Drum Kit Voice Edit Mode	15
1. Voice Parameters	16
1-1. Voice	17
1-2. Volume, Pan	17
1-3. Tuning	17
1-4. Layer Balance	18
1-5. Decay, Cutoff Frequency	18
1-6. Note Number	18
1-7. Channel, Gate Time	18
2. Input Common Parameters	19
2-1. Cross Fade	19
2-2. Reverb Send	19
2-3. Alternate Group, Key Assign Mode	19
2-4. Hold Mode	20
2-5. Key Off Enable	20
2-6. Function	20
2-7. Pad Song	20
2-8. Rim To Pad	21

3. Reverb Parameter 21
 3-1. Reverb Type, Time 21
 3-2. Reverb Master Return 21

4. Setup 22
 4-1. Program Change, Bank Select 22
 4-2. Volume, Pan 22
 4-3. Drum Kit Voice Copy 22

5. Drum Kit Common Parameters 23
 5-1. Volume 23
 5-2. Drum Reverb Send 23
 5-3. Hi-hat Sensitivity 23
 5-4. Song Select 23
 5-5. Drum Kit Name 23

Song Job Mode 24
 1. Tempo, Repeat Playback 24
 2. Program Change, Bank Select 24
 3. Volume, Pan 25
 4. Song Copy 25
 5. Quantize 25
 6. Clear Track 26
 7. Merge Track 26
 8. Clear Song 26
 9. Song Name 26

Utility Mode 27

1. SYSTEM Group 28
 1-1. Learn Mode 28
 1-2. Trigger Bypass 28
 1-3. Volume Mode 28
 1-4. Jump to Recent Page 28
 1-5. Hi-Hat Offset 29
 1-6. Factory Set 29

2. MIDI Group 29
 2-1. Bulk dump 29
 2-2. Channel 10 Program Change/Channel Event
 Receive 30
 2-3. Receive Program Change/System
 Exclusive Messages 30
 2-4. Program Change Table 31
 2-5. MIDI Mode 31
 2-6. Device Number, Local Control 31
 2-7. MIDI Merge 31
 2-8. Dump Interval 32
 2-9. Send Hi-Hat Control 32
 2-10. Host Thru Port 32

3. Sequencer Group 32
 3-1. Click Voice 32
 3-2. Click Tune 33
 3-3. Click Note Number 33
 3-4. MIDI Control 33
 3-5. Count Switch 33
 3-6. Sync Mode 33
 3-7. Use Tempo 34
 3-8. Click Mode 34

4. TG (Tone Generator) Group 34
 4-1. Equalizer (EQ) 34
 4-2. Tuning 34
 4-3. Volume 34
 4-4. Reverb Bypass 35

5. MAP (Drum Map) Group 35
 5-1. Voice 35
 5-2. Volume, Pan 36
 5-3. Tuning 36
 5-4. Layer Balance 36
 5-5. Decay, Cutoff Frequency 36
 5-6. Reverb Send 36
 5-7. Alternate Group, Key Assign Mode 37
 5-8. Key Off Enable 37
 5-9. Map Copy 37

Drum Voice List 38
GM Keyboard Voice List 42
Preset Drum Kit List 42
Preset Song List 49
Trigger Setup List 49
MIDI Data Format 50
MIDI Implementation Chart 52
Blank Chart 53

DTXPRESS Internal Makeup

■ The DTXPRESS' Internal Signal Flow

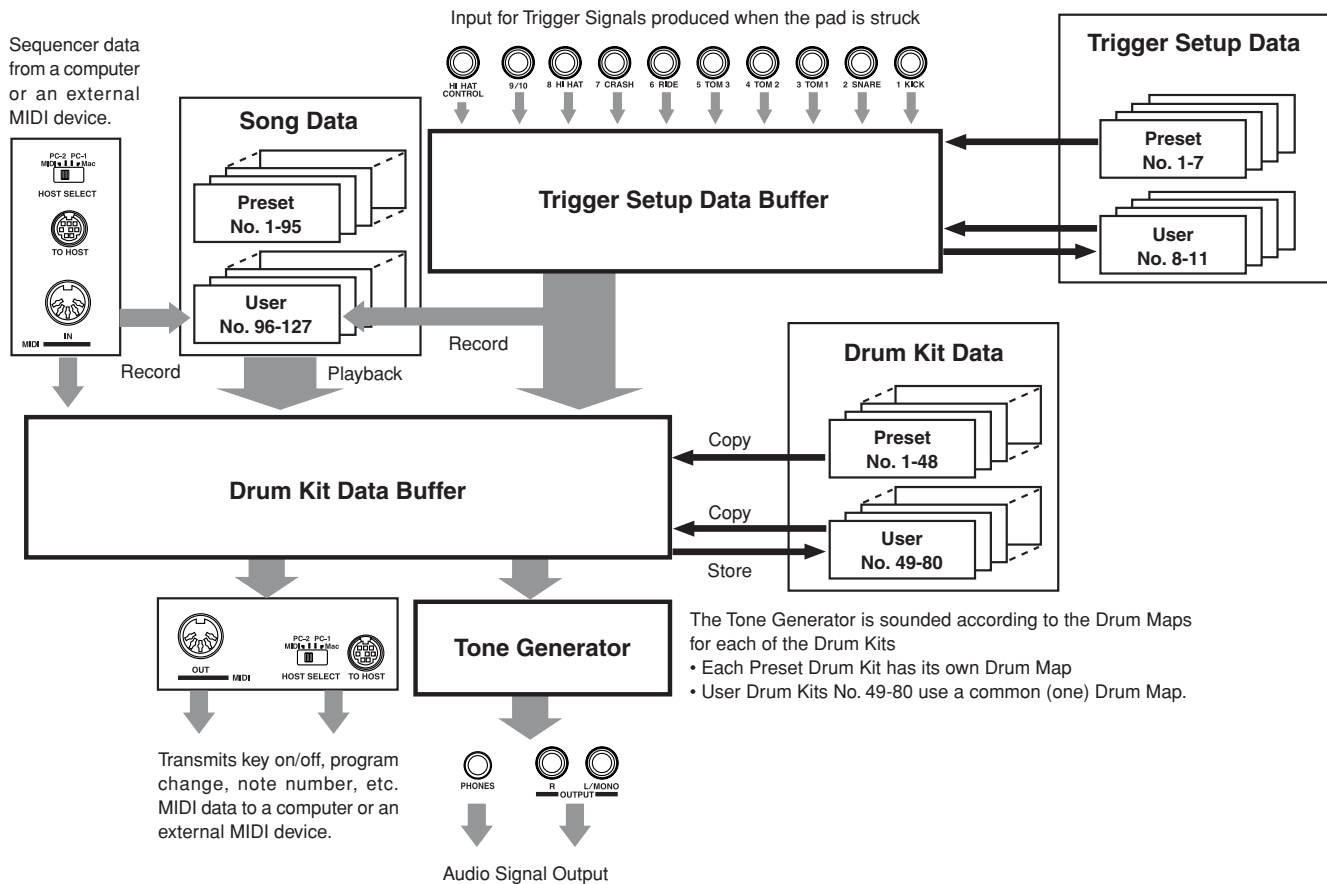

● Pad Data Signal Flow

In order for the DTXPRESS to effectively manage trigger signals transmitted from the pads connected to the Trigger Input Jacks (1 KICK, 2 SNARE, ... 9/10) and the HI HAT CONTROL jack, trigger signals are adjusted to a suitable signal in the Trigger Setup Buffer using the **Trigger Setup**.

Signals transmitted from the Trigger Setup Buffer will enter the Drum Kit Buffer.

In the Drum Kit Buffer, the **Drum Kit** is set as to what voices will be used and how voices will be delivered for each of the Trigger Input Sources. The **Tone Generator's Voices** will be produced according to these settings and its audio signal will be transmitted to the OUTPUT jacks and PHONES jack.

● Trigger Setup Data

This mode is used for adjusting the trigger input, from pads and trigger sensors connected to the Trigger Input Jacks, to a suitable signal the sensitivity and velocity curve settings. (The signals characteristics will change according to the strength of the hit.) Also, cross-talk and double-trigger can be effectively eliminated with the settings available here.

Along with 7 preset trigger setups (No. 1-7), there are another 4 user trigger setups (No. 8-11) available for storing original setups. After selecting a trigger setup for use, the data will be copied to the Trigger Setup Data Buffer where the copied data will be used in performance. (Refer to the illustration above.)

Setup data can be freely changed in the Trigger Setup Edit mode and saved, if necessary, to the User Trigger Setup's memory (No. 8-11).

● Drum Kit Data

This mode is used for setting drum kit voices, for example, assign a voice to each pad (trigger input source) used in the drum kit and perform settings such as selecting the voice, tuning, reverb level, etc.

The DTXPRESS has 48 preset (No. 1-48) drum kits and another 32 user (No. 49-80) drum kits that are used for saving original drum kits created by the user.

As in the Trigger Setup, the selected drum kit's data will be copied to the Drum Kit Data Buffer where the copied data will be used in performance. (Refer to the illustration above.) This Drum Kit data can be freely changed in the Drum Kit Voice Edit mode and saved, if necessary, to the User Drum Kit's memory (No. 49-80).

● **Tone Generator**

The DTXPRESS' tone generator contains a total of 910 drum and percussion voices.

Preset Drum Kits use an exclusive Drum Kit Map for each kit in which voices for the kit are assigned to individual MIDI note numbers.

The User Drum Kit uses one drum map (User Drum Map) that is common for all drum kit numbers 49-80. The Utility mode's [5. Map (Drum Map)] group can be used to assign voices to each MIDI note number (0-127) and edit the drum kit.

Along with the DTXPRESS' drum and percussion voices, the DTXPRESS possesses a variety of keyboard voices (128 voices) that are based on the GM System Level 1. It is possible to deliver piano and brass voices by hitting the pad and playback songs with the internal sequencer or from external sequencer data. A maximum of 32 voices can be delivered simultaneously.

● **Song Data**

The DTXPRESS contains 95 preset songs (No. 1-95) that consist of not only drum parts but also keyboard, brass, etc., accompaniment parts.

You can enjoy the songs as they are or mute the song's drums or a single drum voice (snare drum, etc.) and play along with the drum. Also, you can record your performance to the User Song memory (No. 96-127). Each song consists of two tracks and each track can include data for MIDI channels 1-16.

● **MIDI/TO HOST Jacks**

All drum kit setting data and sequencer data are managed with a MIDI data.

By connecting the DTXPRESS' MIDI OUT/IN jacks to the MIDI IN/OUT jacks on an external MIDI device, MIDI data can be exchanged. The TO/HOST jack is used to transmit and receive MIDI data from a computer.

According to the MIDI data transmitted from an external MIDI device or computer connected to the DTXPRESS, drum kits can be switched, the song can be controlled and the tone generator can be sounded freely.

For example, song data (sequencer data) transmitted from an external sequencer to the DTXPRESS' MIDI IN jack can be used to play the voices produced by the DTXPRESS' internal tone generator. You can use the DTXPRESS to play along with these songs and record both external sequencer and DTXPRESS parts.

Also, MIDI data produced when the DTXPRESS can be transmitted to an external MIDI device and/or computer. Playing the DTXPRESS in this configuration allows you to trigger the external tone generator's voices and when a drum kit is switched, have the external MIDI keyboard's voice change as well. The DTXPRESS' data can be stored to, as well as retrieved from an external MIDI device.

■ **Basic Operations for Data Setting**

● **Enter the Modes**

Press each Mode button.

Double-click a button to jump directly to the specified page the mode you want to enter.

- **Drum Kit Play Mode** [PLAY]
- **Trigger Setup Edit Mode** [TRIG]
- **Utility Mode** [UTIL]
- **Drum Kit Voice Edit Mode** [VOICE]
- **Song Job Mode** [SONG]



● **Page Navigation**

Press the [PAGE▲] button to move to the previous page, the [PAGE▼] button to move to the next page. Hold the button to scroll through the pages.



● **Select the Parameter**

The flashing parameter on the display is specified for setting.

- Use the [SEL◀] and [SEL▶] buttons to move the cursor (the flashing character or symbol).
The [SEL◀] button moves the cursor to the left while the [SEL▶] moves the cursor to the right.
- When there is only one parameter on the display, the [SEL◀]/[SEL▶] buttons will not operate.



● **Change the setting**

The setting (value) of flashing parameter on the display can be changed.

- The [VALUE-] and [VALUE+] buttons are used to set parameter values.
When setting values, press the [VALUE-] button to decrease (minus) the value, press the [VALUE+] button to increase (plus) the value. Holding the button will continue to decrease/increase the value.
Hold the [VALUE-] and press the [VALUE+] button will decrease the value by 10. Continue to hold both buttons and the value will continue to decrease.
Hold the [VALUE+] button and press the [VALUE-] button to increase the value by 10. Continue to hold both buttons and the value will continue to increase.



Drum Kit Play Mode

This mode enables you to play the DTXPRESS drum voices by hitting the pads (or drums with trigger sensors attached) connected to the DTXPRESS.

The DTXPRESS automatically enters this mode when the power is switched on.

You can select and play from 48 preset drum kits and 32 user kits.

Also, the drum kit, trigger setup and song specified in this mode will be selected and ready for editing when the Drum Kit Voice Edit, Trigger Setup Edit and Song Job modes are entered.

■ Entering the Drum Kit Play Mode

Press the [PLAY] button on the front panel.

Once the Drum Kit Play mode is entered, the Drum Kit & Song display shown below will appear.

PLAY



```
KIT =1 Acoustic
SONG=1 Latinia
```

■ What's in the Drum Kit Play Mode

The Drum Kit Play mode contains the three setting displays shown below.

- 1. Drum Kit & Song** (P. 6)
This display is used for selecting the drum kit and song.
- 2. Trigger Setup & Tempo** (P. 6)
This display is used for selecting the trigger setup and song settings.
- 3. Song & Mute** (P. 7)
This display is used for selecting the song and specifying the drum mute during the song.

Procedure

1. Press the [PLAY] button to enter the drum kit play mode.
2. Use the [PAGE▲]/[PAGE▼] buttons to select the page you want to set.
3. Use the [SEL◀]/[SEL▶] buttons to move the cursor to the parameter you want to set. The parameter will flash.
4. Use the [VALUE-]/[VALUE+] buttons to set the parameter's value.

HINT Press the [SHIFT]+[PAGE▼] buttons, in any Drum Kit Play mode display, to jump to the Trigger Setup & Tempo display with the cursor moved to tempo value.

1. Drum Kit & Song

This display is used for selecting the drum kit and song.

```
KIT =1 Acoustic
SONG=1 Latinia
```

① KIT (Drum Kit)

[Range] 1-80

Selects the drum kit. The drum kit number and drum kit name will be displayed. Preset kits are numbered 1-48 and user kits are numbered 49-80.

When a pad is hit, the selected drum kit voice will be delivered. Also, this drum kit will be specified for editing when the Drum Kit Voice Edit mode is entered.

- * Once a setting is changed in the Drum Kit Voice Edit mode, "*" will appear between "KIT" and "=" until the data is stored.
- * Refer to the [Preset Drum Kit List] (P. 42)

② SONG

[Range] 1-127

Selects the song. The song number and song name will be displayed. Preset songs are numbered 1-95 and user songs are numbered 96-127.

The selected song will playback when the [START/S] button is pressed.

- * When the rhythm mute ([SHIFT]+[PAGE▲]) is applied, the last letter of the song name will be "■".
- * Refer to [About the Song] (P. 8).
- * Refer to the [Preset Song List] (P. 49).

2. Trigger Setup & Tempo

This display is used for selecting the trigger setup and song settings.

HINT Press the [SHIFT]+[PAGE▼] buttons, in any Drum Kit Play mode display, to jump to the following display with the cursor moved to tempo value.

```
TRIG =1 Medium
J=110---= 4/4=J
```

① TRIG (Trigger Setup)

[Range] 1-11

Selects the trigger setup to be used. The trigger number and trigger name will be displayed. Presets are numbered 1-7 and user setups are numbered 8-11.

- * For more information on the preset trigger setup, refer to the [Trigger Setup List] (P. 49).
- * Once a setting is changed in the Trigger Edit mode, "*" will appear between "TRIG" and "=" until the data is stored.

② J (Tempo)

[Range] 30-300, ext

Sets the playback tempo for the song.

When the DTXPRESS is controlled by an external sync, “ext.” will be displayed.

* The external sync setting is found in [3-6. Sync Mode] (P. 33).

③ Repeat Playback

[Range] —, rp

Sets the repeat playback (repeat continuously from the beginning to the end of the song) of the song.

When this parameter is set to “rF”, the song will repeat playback. When this parameter is set to “—”, the song will playback normally.

④ Beat

[Range] 1/4-8/4, 1/8-16/8, 1/16-16/16

Sets the beat of the song (metronome).

⑤ Metronome Note Value

[Range] When the beat ④ is set to 3/8, 6/8, 9/8, 12/8, 15/8, the click tempo will be set to

↓ quarter note, ↓ eighth note, ↓ sixteenth note.

When the beat ④ is set to any value that is not listed above, the click tempo will be set to

↓ quarter note, ↓ quarter note (triplet),

↓ eighth note, ↓ eighth note (triplet),

↓ sixteenth note, ↓ sixteenth note (triplet).

Use the note values to set the click tempo of the metronome.

3. Song & Mute

This display is used for selecting the song and specifying the drum mute during the song.

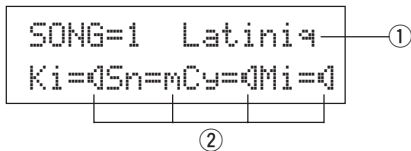

① SONG

[Range] 1-127

Selects the song. The song number and song name will be displayed.

Press the [SONG] button to start playback of the selected song.

* This song select operation is the same as in [1. Drum Kit and Song]. The only difference is whether the display will switch or not when the Groove Check is used.

② Drum Mute

[Range] m (mute; Does not produce sound), n (Produces sound)

Sets the type of drum voice to be muted. The 4 types of voices that can be muted are Ki (kick), Sn (snare), Cy (cymbal) and Mi (others).

*** Drum voice types**

Drum voices are divided into many groups (categories) in accordance with the type of sound i.e. kick, snare, etc. For more information on Drum Voice categories, refer to the [Drum Voice List] (P. 38).

Drum Voice Category Mute Classification

K, k Ki (kick)

S, s Sn (snare)

C, H Cy (cymbal)

T, t, P, E, e, L, m Mi (others)

HINT Since drum voices for pads (triggers) are not muted you can, for example, mute the snare voice of a song and practice the snare part along with song playback (the snare voice is delivered when the pad is hit).

Groove Check Function

Function

As you play the pads along with a song, the DTXPRESS will compare your performance with its song clock and let you know how accurate your timing is.

Display

In the Drum Kit Play mode (from any display) press the [SHIFT]+[SEL▶] (GRV) buttons.

* The Groove Check function will quit when song playback is stopped.

* The top line of the original page is displayed as is.

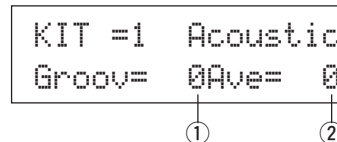

Setting

① Groov (Groove)

[Range] -48 to 0 to +48

The difference in the timing of each stroke on the pad is displayed.

If the timing of the stroke is late compared to the just time, a minus value will be displayed. If your timing is early, a plus value will be displayed. If you timing is perfect, “0” will be displayed.

② Ave (Average)

[Range] -48 to 0 to +48

This function displays the average value of your timing accuracy after the Groove Check function is switched ON.

This function checks your performance on the entire drum set and can check your performance on one song. The information shown in the display is the same as in ① Groov.

* To reset the data, press the [SHIFT]+[SEL▶] buttons twice.

About the Song

The DTXPRESS can internally store data for a maximum of 127 songs that can be played back freely.

Song numbers 1-95 are preset songs and song data in those songs cannot be changed or rewritten.

Song numbers 96-127 are user songs that can be used to record new performance data and also edit song data in.

■ Song Makeup

The Song consists of two sequencer tracks plus header data.

Header data is written at the front of the song and holds information related to the song's tempo, beat, program numbers (voice) for each MIDI channel and volume, etc. Header data is read every time the song is played from the beginning.

Both tracks possess data for MIDI channels 1-16 (except system exclusive data).

During song playback, the sequencer data that is written in the song will be transmitted to the DTXPRESS' tone generator to produce the song.

■ Main Song and Pad Song

Up to four songs can be played back simultaneously.

The song that is selected in the Drum Kit Play mode (P. 6) is called the Main Song. Pressing the [START/S] button will start playback of this song.

The remaining three songs are called Pad Song(s). These songs are played back according to the trigger input (hitting a pad).

■ Metronome

The sequencer produces the metronome.

The metronome can be used either alone or with the Song.

Press the [CLICK] button, in any mode, to start the metronome. The metronome's tempo, voice, etc. are set in the Utility mode [3. Sequencer Group] (P. 32).

Song Playback

■ Main Song Playback

• Select a Song

1. Press the [PLAY] button to enter the Drum Kit Play mode. Use the [PAGE▲]/[PAGE▼] buttons to display either of the displays shown below (Drum Kit & Song or Song & Mute).

• Drum Kit & Song

```
KIT =1 Acoustic
SONG=1 Latinia
```

• Song & Mute

```
SONG=1 Latinia
Ki=0Sn=0Cy=0Mi=0
```

2. Use the [SEL◀]/[SEL▶] buttons to move the cursor to the "SONG=" position.
3. Use the [VALUE-]/[VALUE+] buttons to set the song number of the song you want to playback.

• Set the Tempo, Repeat Playback, Beat and Metronome

1. In the Drum Kit Play mode, use the [PAGE▲]/[PAGE▼] buttons to display the "Trigger Setup & Tempo" display shown below.

```
TRIG =1 Medium
J=120---= 4/4=J
```

2. Use the display shown above to set the Tempo, Repeat Playback, Beat and Metronome Note Value.

• Song Playback (Start/Stop)

Press the [START/S] button, in any display, to start playback of the song (main song).

During playback, press the [START/S] button to stop playback of the song. Press the [START/S] button again and the song will start playback from the beginning.

- * If the pad's function is previously set to the "Main Song Control" function (→ Drum Kit Voice Edit Mode [2-6. Function] P. 20), you can start/stop the main song by hitting the assigned pad.
- * During song playback, the [SONG] button's LED will light for a moment at the beginning of each measure.
- * During song playback, the song cannot be changed.
- * If the song's tempo or voices are irregular, re-select the song.

■ Pad Song Playback (Start/Stop)

To playback a Pad Song, hit the pad that is assigned to the Pad Song you want to playback. Hit the same pad during playback will stop the song. Hit the pad again to start the song from the beginning.

- * Before using, set the pad's function to "Pad Song Control" and assign a song to the pad (→ Drum Kit Voice Edit mode [2-6. Function], [2-7. Pad Song] P. 20).
- * The song can be played one measure at a time, each measure triggered with a stroke on the pad (→ Drum Kit Voice Edit mode [2-7. Pad Song] P. 20)
- * If the Pad Song's tempo or voices are irregular, re-select the Drum Kit.

■ Song Playback Functions

During song playback, the song can be repeated and volume levels for each instrument can be changed.

• Volume Control

With each of the knobs on the front panel, the following volume levels can be controlled.

- [ACCOMP VOL]: The volume of the song's accompaniment.
- [SHIFT]+[ACCOMP VOL]: The volume of the song's snare drum.
- [CLICK VOL]: The volume of the metronome's click.
- [SHIFT]+[CLICK VOL]: the volume of the song's bass drum.

If the Utility mode's [1-3. Volume Mode] (P. 28) is set to "live", the following volume levels can be controlled.

- [ACCOMP VOL]: The volume of the song's snare drum.
- [SHIFT]+[ACCOMP VOL]: The volume of the song's cymbal.
- [CLICK VOL]: The volume of the song's bass drum.
- [SHIFT]+[CLICK VOL]: The volume of the song's other instruments.

• Set the Metronome

The voice, pitch and MIDI note number of the metronome's click voice can be set. ([3-1. Click Voice] (P. 32), [3-2. Click Tune] (P. 33), [3-3. Click Note Number] (P. 33))

• Count Function

If the Utility mode's [3-5. Count Switch] (P. 33) is set to "ON" when the main song is played back, the first measure of the song will be preceded by a two measure count.

• MIDI Control by an External Device

- If the Utility mode's [3-4. MIDI Control] (P. 33) is set to "ON", playback of the main song can be controlled with system real-time messages (start/continue/stop) from the MIDI IN/TO HOST jack.
- If the Utility mode's [3-6. Sync Mode] (P. 33) is set to "ext" or "midi", the song playback can be synchronized to the clock of an external MIDI device.

• Rhythm Mute Function

When the [SHIFT]+[PAGE▲] buttons are pressed, the MIDI channels (usually channel 10) that are assigned to track 1 of the song and the drum voice will be muted (sound will not be delivered).

- * When the Rhythm Mute is applied, program changes will be ignored so the drum kit cannot be changed.

• Other Functions

- This function can set whether the song will playback according to the tempo information in the song or according to the tempo that is set when the song is switched. (→ P. 34 [3-7. Use Tempo])
- This function can set whether or not the click voice will be delivered automatically when the song is played back. (→ P. 34 [3-8. Click Mode])
- The metronome's click voice can be switched ON/OFF by hitting the pad. (→ P. 20 [2-6. Function])

Song Recording

Song recording lets you record data, produced as the drum kit is played, to the sequencer in real-time (one track at a time). All MIDI channels (1-16) are recorded simultaneously. Also, data produced by a MIDI keyboard connected to the MIDI IN jack can be recorded as well as sequencer data received via the MIDI IN/TO HOST jacks.

According to the recorded sequencer data (performance information), drum kits and voices can be changed during song playback. The songs that are recorded can be played back and edited in the same manner as preset songs (No. 1-48) with the Song Job mode.

Song Record Settings

Select the Song

1. Press the [PLAY] button to enter the Drum Kit Play mode, set the User Song number (No. 96-127) that you want to record to.

* Only User Songs (No. 96-127) can be used for recording. Preset Songs (No. 1-95) cannot be used for recording.

Set the Recording Conditions (Record Standby)

2. Press the [SHIFT]+[START/S] buttons, the record mode will be in standby. The following display will appear.

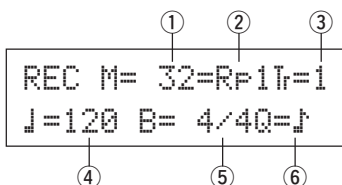

3. Use the display shown above to set the following recording conditions.

1 M (the number of measures that will be recorded) [Range] 1-999

Assigns the number of measures that will be recorded. When there is data in the other track, the number of measures in that track will decide the length of the song and this length cannot be changed.

2 Record Mode

Select the method of recording from the following.

Overwrite (Ovr): The record operation will be in a repeat mode. When the song reaches the end of the last measure, it will automatically start again from the beginning and new data will be added to the track's previous data.

Replace (RPT): When the song reaches the end of the measure number assigned in "M" or the [START/S] button is pressed, recording will stop (the song will not repeat).

3 TR (Specify the Track for Recording)

Selects which track ("1" or "2") will be recorded.

4 J (Metronome Tempo) [Range] 30-300

Sets the metronome tempo for recording

5 B (Beat) [Range] 1/4-8/4, 1/8-16/8, 1/16-16/16

Sets the beat of the song (metronome) for recording.

6 Q (Quantize Accuracy)

[Range] J quarter note, J3 quarter note (triplet)
 J eighth note, J3 eighth note (triplet)
 J3 sixteenth note, J33 sixteenth note (triplet), no

The Quantize function* can be used when recording.

When set to "no", the Quantize function will not operate.

Quantize: This function is used to correct the timing of recorded MIDI note data. The accuracy of quantization is assigned by the note value.

* You can also use the Quantize function after recording is complete. (Song Job mode [5. Quantize] P. 25)

Record

4. Press the [START/S] button to start recording.

* If the Utility mode's [3-4. MIDI Control] (P. 33) is set to "on", the recording operation can be started with a system real time message (start) received via the MIDI IN/TO HOST jacks.

* When the track assigned for recording contains data and the [START/S] button is pressed, the error message "Data not Empty" will appear and the recording operation will not be carried out.

While the song is recording, the following display will appear (only displayed, cannot change).

When the Record Mode = Replace ("RPT")

```
REC M= 5=RPT=1
Now Recording.
```

When the Record Mode = Overwrite ("Ovr")

```
REC M= 5=OvrT=1
UNDO Press ENT
```

• Next to "M=" the measure number currently being recorded is displayed.

• When the Record mode is set to "Ovr", press the [SAVE/ENT] button to "Undo" (do again) the record operation. Press the [SAVE/ENT] button while recording to start recording from the top of the song. The data previously recorded from the beginning of the song, up until the [SAVE/ENT] button was pressed, will revert to the data originally present.

Stop Recording

5. When the song reaches the end of the assigned measure number, recording will automatically stop and the DTXPRESS will return to the Drum Kit Play mode (Drum Kit & Song display).

* Recording can also be stopped anytime by pressing the [START/S] button.

* If the power is switched off while recording, all the data in the User Song may be lost. Please use caution.

Data recorded in the tracks cannot be overwritten. To record new data, use the Song Job mode's [6. Clear Track] (P. 26) or [8. Clear Song] (P. 26) operations to erase track data.

Trigger Setup Edit Mode

This mode contains various settings related to trigger input from the pads and trigger sensors that are connected to the DTXPRESS.

It allows you to adjust pad sensitivity and assign drum voices to each trigger input. Trigger Setup data consists of seven preset types (No. 1-7) and four original setup types (No. 8-11) for storing user setup data.

■ What you can do with the Trigger Setup Edit Mode

The Trigger Setup Edit Mode lets you alter a variety of settings for each of the trigger inputs jacks (1-10) of the Trigger Setup.

You can edit both preset (No. 1-7) and user Trigger Setups (No. 8-11).

The edited Trigger Setup can be stored in a User Trigger Setup (No. 8-11) using the Store Operation.

- * Selecting another Trigger Setup before storing your changes will result in the data reverting to its default settings.
- * Data cannot be stored to preset Trigger Setup (No. 1- 7).

■ Entering the Trigger Setup Edit Mode

Press the [TRIG] button on the front panel.

Once the Trigger Setup Edit Mode is entered, the INPUT parameter's main page (pad type), shown below, will be displayed.

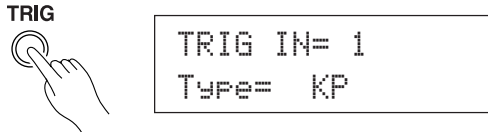

- * Double-click the [TRIG] button to enter the Trigger Setup Edit Mode. The [1-2. Gain, Minimum Velocity] display will appear.

■ What's in the Trigger Setup Edit Mode

The Trigger Setup Edit Mode is divided into two sub-groups.

1. **INPUT Parameters** → P. 12
Contains specific settings for each pad (1-10).
2. **COMMON Parameters** → P. 14
Contains common settings for all pad inputs.

Procedure

1. Before editing, it is necessary to select the trigger setup you want to edit in the drum kit play mode [Trigger Setup & Tempo].
2. Press the [TRIG] button to enter the Trigger Setup Edit mode.
3. Use the [PAGE▲], [PAGE▼] buttons to display the list you want to edit.
 - * If the Utility mode's [Jump to Recent Page] parameter (P. 28) is set to "on", the DTXPRESS will display the page last edited when entering the Trigger Setup Edit mode.
4. Use the [SEL◀], [SEL▶] buttons to move the cursor to the list you want to edit. The list will flash.
 - * If there is only one list, it is not necessary to move the cursor.

5. Use the [VALUE-], [VALUE+] buttons to set the parameter's value or ON/OFF setting.
 - * Once a setting is changed, "*" will appear on the display next to "TRIG". After data is saved, the mark will disappear.

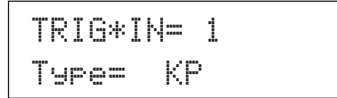

6. To store changes in the User Trigger Setup, use the following procedure.
 - * The changes you made will be lost if another trigger setup is selected before your changes have been stored.

- 6-1. Press the [SAVE/ENT] button. The following display will appear.

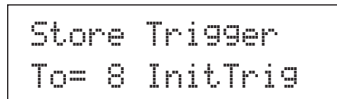

- 6-2. Use the [VALUE-], [VALUE+] buttons to assign the User Trigger Setup number (8-11) (located next to "To=") for storing your changes. The number and setup name will appear.
- 6-3. Press the [SAVE/ENT] button, the following display will appear asking for confirmation before the store operation is carried out.

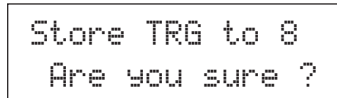

- 6-4. Press the [SAVE/ENT] or [VALUE+] button, the store operation will be carried out.
 - * Press the [VALUE-] button to cancel the store operation.

The following display will appear after the store operation is completed.

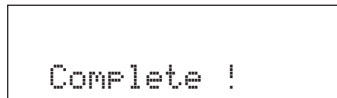

Trigger Setup Edit Mode Function List

	Page
1. INPUT Parameters	12
1-1. Pad Type	12
1-2. Gain, Minimum Velocity	12
1-3. Velocity Curve	13
1-4. Self Rejection, Rejection	13
1-5. Specific Rejection	13
1-6. Copy Input	13
2. COMMON Parameters	14
2-1. Increment/Decrement	14
2-2. Input Exchange	14
2-3. Trigger Setup Name	14

Trigger Setup Edit Mode

1. INPUT Parameters

Contains specific settings for each of the pads (1-10). This function is divided into the following 6 pages.

- 1-1. Pad Type 12
- 1-2. Gain, Minimum Velocity 12
- 1-3. Velocity Curve 13
- 1-4. Self Rejection, Rejection 13
- 1-5. Specific Rejection 13
- 1-6. Trigger Setup Copy 13

1-1. Pad Type

Sets the type of pad or trigger sensor that is connected to the trigger input jack ①. By selecting the appropriate pad type, pad functions can be used to their full potential.

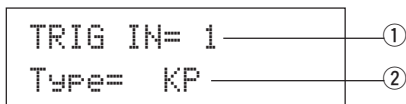

① TRIG IN (Trigger Input Number) [Range] 1-10

Assigns the trigger input jack number for the pad you want to edit.
* According to the setting in the utility mode's [1-1. Learn Mode] (P. 28) trigger input jack numbers can be assigned by hitting the pad.

② Type (Pad Type)

Sets the type of pad that is connected to the trigger input jack assigned in ① TRIG IN.
* Values set in [1-2. Gain, Minimum Velocity] (P. 12) and [1-4. Self Rejection] (P. 13) will automatically select the proper value for the pad type you set here.
* The "HH contrler" can only be assigned to Input Jack 1. Connect the Hi-hat Controller HH60, HH80 or HH80A to Input Jack 1 and set to "HH contrler" to use in place of a kick pedal. Use a cable with a stereo plug when connecting a Hi-hat controller.

Pad types are defined as follows.

- TP snare TP60, TP80, TP80S used as a snare pad.
- TP tom TP60, TP80, TP80S used as tom pads.
- TP HH TP60, TP80, TP80S used as a hi-hat pad.
- KP KP60, KP80, KP80A used.
- PCY ride PCY60, PCY80, PCY80S used as ride cymbal pads.
- PCY crash PCY60, PCY80, PCY80S used as crash cymbal pads.
- PCY cup PCY10, etc. used as the cymbal cup.
- BP BP80 used.
- DT snare DT10, DT20 attach to the snare drum.
- DT hi tom DT10, DT20 attach to small toms
- DT lo tom DT10, DT20 attach to large toms
- DT kick 1 DT10, DT20 attach to small bass drum
- DT kick 2 DT10, DT20 attach to large bass drum
- misc 1 Extensive use1—high sensitivity type.
Rim switch function is good for snare/tom use.

- misc 2 Extensive use 2—high sensitivity type.
Rim switch function is good for cymbal use.
- misc 3 Extensive use 3—normal sensitivity type.
Rim switch is good for snare/tom use.
- misc 4 Extensive use 4—normal sensitivity type.
Rim switch function is good for cymbal use.
- misc 5 Extensive use 5—low sensitivity type.
Rim switch is good for snare/tom use.
- misc 6 Extensive use 6—low sensitivity type.
Rim switch function is good for cymbal use.
- HH contrler Connect the HH60, HH80, HH80A to Trigger Input jack 1 to use as a kick pedal.
* The volume (velocity) is fixed.

* The DT10, DT20 are Yamaha Drum Trigger Sensors.

1-2. Gain, Minimum Velocity

This function sets the input sensitivity (Gain) and velocity range (Minimum Velocity) for each input jack ①.

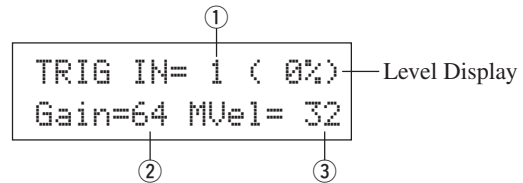

① TRIG IN (Trigger Input Number)

Assigns the trigger input jack number. (The same procedure as in [1-1. Pad Type]).

② GAIN (Input Gain)

[Range] 0-99

Adjusts the input gain level (minimum sensitivity) for the trigger input jack assigned in step ① TRIG IN.
Entering a larger value here allows smaller input levels to sound the voice.

* This value will be automatically set after the appropriate pad type is set in [1-1. Pad Type]. Some fine-tuning of the value will be necessary.

③ MVel (Minimum Velocity)

[Range] 1-127

Sets the MIDI Velocity (volume) that is transmitted when the pad is hit the weakest. Large values will produce a high volume level even if the pad is hit softly. However, this will result in a narrow volume range making it difficult to adequately produce wider dynamic levels.

If "HH contrler" is set for the pad type, the value set here will be transmitted as the velocity.

The trigger input level will be displayed as a % in the upper right hand corner of the display. The maximum velocity (input level 99%) will be 127. The level is low when the pad is hit the weakest so a wider dynamic range will be possible.

* This value will be automatically set after the appropriate pad type is set in [1-1. Pad Type]. Some fine-tuning of the value will be necessary.

1-3. Velocity Curve

This function sets the MIDI Velocity Curve for the sensitivity for each input jack ①.

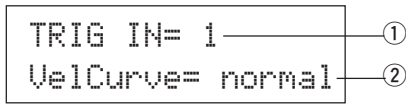

① TRIG IN (Trigger Input Number)

Assigns the trigger input jack number (the same procedure as in [1-1. Pad Type]).

② VelCurve (Velocity Curve)

Sets the Input Velocity Curve for the trigger input jack assigned in TRIG IN ①.

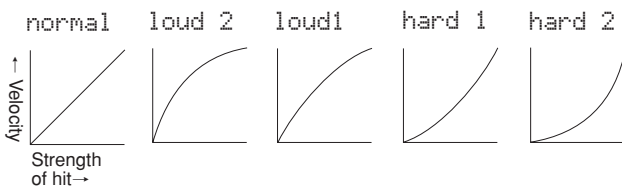

1-4. Self Rejection, Rejection

This function is used to prevent double triggers* and cross talk (mixed input signals between the jacks) for each input jack ①.

* **double trigger:** When 2 sounds are played at the same time.

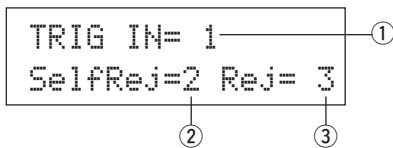

① TRIG IN (Trigger Input Number)

Assigns the trigger input jack number (the same procedure as in [1-1. Pad Type]).

② SelfRej (Self Rejection)

[Range] 0-9

Prevents double triggers from occurring in the input jack assigned in TRIG IN ①. After an event is detected, further events will be automatically muted for a certain length of time. Larger values set longer times.

③ Rej (Rejection)

[Range] 0-9

Prevents cross talk from occurring in the input jack assigned in TRIG IN ①. Events triggered by other pads (input jacks) that are of a lower input value than what is set here will not be delivered for a set length of time.

1-5. Specific Rejection

This function prevents cross talk from occurring between two specified input jacks ① and ③.

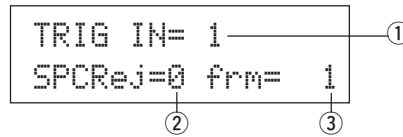

① TRIG IN (Trigger Input Number)

Assigns the trigger input jack number (the same procedure as in [1-1. Pad Type]).

② SPCRej (Specific Rejection)

[Range] 0-9

After an event occurs from the pad from the input jack assigned in ③, the pad of the input jack assigned in TRIG IN ① will not sound for a certain length of time unless the level is greater than the value assigned here.

③ frm (Assigned Destination Trigger Input Number)

[Range] 1-10, 6&7

Sets the destination trigger input jack number of the pad that will be rejected. When "6&7" is selected, both trigger inputs 6 and 7 will be assigned.

1-6. Trigger Setup Copy

This function copies all data settings in [1-1. Pad Type] to [1-5. Specific Rejection] from input jack ① to another input jack ②.

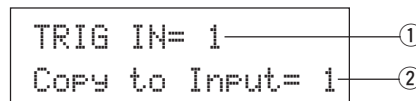

! When the Trigger Setup Copy operation is carried out, the trigger setup data will be replaced with the settings of the copy source.

① TRIG IN (Trigger Input Number)

Sets the trigger input jack number (1-10) of the pad copy source.

② Copy to Input (Trigger Input Number Copy Destination)

Sets the trigger input jack number (1-10) of the copy destination.

Procedure

1. In the display shown above, assign the copy source and copy destination, press the [SAVE/ENT] button. The following display will appear asking for confirmation before the copy operation is carried out.

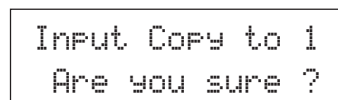

2. Press the [SAVE/ENT] or [VALUE+] button, the copy operation will be carried out.

* Press the [VALUE-] button to cancel the copy operation.

When the copy operation is complete, "Complete!" will appear.

Trigger Setup Edit Mode

2. COMMON Parameters

Contains common settings for all pad inputs (1-10). This group is divided into the following 3 pages.

- 2-1. Increment/Decrement 14
- 2-2. Input Exchange 14
- 2-3. Trigger Setup Name 14

2-1. Increment/Decrement

This sets the pad function that allows the currently selected drum kit number to be increased or decreased by 1 by hitting the specified pad.

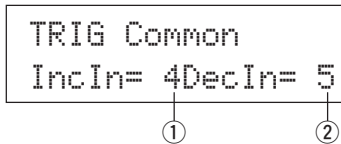

① Incin (Pad for Increment)

[Range] —, 1-10

Assigns the trigger input jack number that is set for the increment (+1) function. “--” will appear when this function is not assigned to the pad.

② Decin (Pad for Decrement)

[Range] —, 1-10

Assigns the trigger input jack number that is set for the decrement (-1) function. “--” will appear when this function is not assigned to the pad.

- * Even when the drum kit is changed, the pads connected to the assigned trigger input jacks will retain their increment/decrement functions. To assign this function to each drum kit, refer to the Drum Kit Voice Edit mode's [2-6. Function] (P.20)

2-2. Input Exchange

Switches the trigger signal from the pads between trigger input jacks 1 and 9/10.

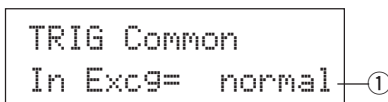

① In Excg (Input Exchange)

normal: Normal operation.

In10, 1/9: The signals from Input Jacks 1 and 9/10 are switched.

When the input jack 1 pad is hit.

- This event will be recognized as a signal from the input jack 10 pad (as if a trigger were received from input jack 10) and operate accordingly.

When the input jack 1 rim is hit.

- Normal operation. This event will be recognized as a signal from the input jack 1 rim.

When the input jack 9 pad is hit.

- This event will be recognized as a signal from the input jack 1 pad (as if a trigger were received from input jack 1) and operate accordingly.

When the input jack 10 pad is hit.

- This event will be recognized as a signal from the input jack 9 pad (as if a trigger were received from input jack 9) and operate accordingly.

2-3. Trigger Setup Name

Changes the name of the currently selected (currently being edited) Trigger Setup.

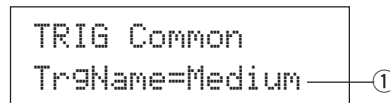

① TrgName (Trigger Setup Name)

Procedure

1. In the display shown above, use the [SEL◀]/[SEL▶] buttons to move the cursor to the character you want to change.
2. Use the [VALUE-]/[VALUE+] buttons to select the alphabet, number or symbol.
3. Repeat steps 1 and 2 above to create the Trigger Setup name using a maximum of 8 characters.

- The available characters to choose from are (in order):

```
space
!"#$%&'()*+,-./0123456789:;<=>?@
ABCDEFGHIJKLMNPOQRSTUVWXYZ[^\`
abcdefghijklmnopqrstuvwxyz{|}~
```

Drum Kit Voice Edit Mode

This mode lets you set which voice and how it will be triggered for each pad (trigger input source) in the currently selected drum kit.

■ What you can do with the Drum Kit Voice Edit Mode

This mode contains various settings related to the currently selected drum kit (data in the edit buffer for the drum kit).

You can edit both preset (No. 1-48) and user drum kits (No. 49-80).

The edited drum kit can be stored in a User Drum Kit (No. 49-80) using the Store Operation.

- * Selecting another drum kit before storing your changes will result in the data reverting to its default settings.
- * Data cannot be stored to preset drum kits (No. 1-48).

■ Entering the Drum Kit Voice Edit Mode

Press the [VOICE] button on the front panel.

Once the Drum Kit Voice Edit Mode is entered, the Voice Parameter main page (Voice) shown below will be displayed.

VOICE



```
KIT IN=Pad 1 V=1
=K/017 BDaftty1
```

- * Double-click the [VOICE] button to enter the Drum Kit Voice Edit Mode. The [1-2. Volume, Pan] display will appear.

■ What's in the Drum Kit Voice Edit Mode

The Drum Kit Voice edit Mode is divided into the following five sub-groups.

- 1. Voice Parameters** (→ P. 16)
Sets the voice for each input source of the pad.
- 2. Input Common Parameters** (→ P. 19)
Common settings related to the 2 layers for each pad input source's voice parameter.
- 3. Reverb Parameters** (→ P. 21)
Sets the internal reverb effect.
- 4. Setup** (→ P. 22)
When the drum kit is selected, this function copies the drum kit voice settings and MIDI transmit settings.
- 5. Drum Kit Common Parameters** (→ P. 23)
Common settings for the entire drum kit.

Procedure

1. Before editing, it is necessary to select the drum kit you want to edit in the Drum Kit Play Mode of the [Drum Kit & Song] display.
2. Press the [VOICE] button to enter the Drum Kit Voice Edit Mode.

3. Use the [PAGE▲], [PAGE▼] buttons to display the page you want to edit.

* If the Utility Mode's [1-4. Jump to Recent Page] (P. 28) parameter is set to "on", the DTXPRESS will display the page last edited when entering the Drum Kit Voice Edit Mode.

4. Use the [SEL◀]/[SEL▶] buttons to move the cursor to the parameter you want to edit. The parameter will flash.

* If there is only one parameter, it is not necessary to move the cursor.

5. Use the [VALUE-]/[VALUE+] buttons to set the parameter's value or ON/OFF setting. Pressing the [VOICE] button lets you listen to the Drum Kit Voice while editing.

* Once a setting is changed, "*" will appear on the display next to "KIT". After data is stored, the mark will disappear.

```
KIT*IN=Pad 1 V=1
=K/019 MapleA20
```

6. To store your changes in a User Drum Kit, use the Store Operation described below.

* The changes you made will be lost if another drum kit is selected before your changes have been stored.

- 6-1. Press the [SAVE/ENT] button. The following display will appear.

```
Store Drunkit
To= 49 Init Kit
```

- 6-2. Use the [VALUE-]/[VALUE+] buttons to assign the Drum Kit number (49-80) (located next to "To="). The number and drum kit name will appear.

- 6-3. Press the [SAVE/ENT] button, the following display will appear asking for confirmation before the store operation is carried out.

```
Store KIT to= 49
Are you sure ?
```

- 6-4. Press the [SAVE/ENT] or [VALUE+] button, the store operation will be carried out.

* Press the [VALUE-] button to cancel the store operation.

The following display will appear after the store operation is complete.

```
Complete !
```

Drum Kit Voice Edit Mode Function List

	Page
1. Voice Parameters	16
1-1. Voice	17
1-2. Volume, Pan	17
1-3. Tuning	17
1-4. Layer Balance	18
1-5. Decay, Cutoff Frequency	18
1-6. Note Number	18
1-7. Channel, Gate Time	18
2. Input Common Parameters	19
2-1. Cross Fade	19
2-2. Reverb Send	19
2-3. Alternate Group, Key Assign Mode	19
2-4. Hold Mode	20
2-5. Key Off Enable	20
2-6. Function	20
2-7. Pad Song	20
2-8. Rim to Pad	21
3. Reverb Parameters	21
3-1. Reverb Type, Time	21
3-2. Reverb Master Return	21
4. Setup	22
4-1. Program Change, Bank Select	22
4-2. Volume, Pan	22
4-3. Drum Kit Voice Copy	22
5. Drum Kit Common Parameters	23
5-1. Volume	23
5-2. Drum Reverb Send	23
5-3. Hi-Hat Sensitivity	23
5-4. Song Select	23
5-5. Drum Kit Name	23

1. Voice Parameters

Sets the voice for each input source of the pad.
 The Input Source is trigger data that is transmitted by the pads or trigger sensors connected to input jacks 1-10 of the DTXPRESS. When monaural pads TP60/80, KP60/80, PCY60/80, DT10/20, etc. are used, one Input Source will be assigned to one input jack. When stereo pads TP80S, PCY80S, etc. are used, two Input Sources (pad input and rim switch input or 2 kinds of pad input, etc.) will be assigned to one input jack.
 The Voice Parameter is divided into the following 7 pages.

1-1. Voice	17
1-2. Volume Pan	17
1-3. Tuning	17
1-4. Layer Balance	18
1-5. Decay, Cutoff Frequency	18
1-6. Note Number	18
1-7. Channel, Gate Time	18

Select the Input Source for Editing

In Voice Parameter edit display, first it is necessary to select the input source ① for editing.

Also, 2 voices/key on events/occurrences (2 voices delivered with one strike of the pad) can be assigned to one trigger input. This use is called "2 layer". When a 2 layer is used, assign the layer number ② that is used.

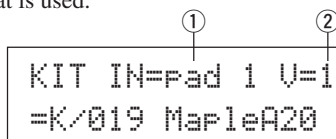

① IN (Input Source)

Each Input Source is defined as follows.

- Pad 1** Pad input for Trigger Input Jack 1.
- rim 1** Rim switch input for Trigger Input Jack 1.
- Pad 2** Pad input for Trigger Input Jack 2.
- rim 2** Rim switch input for Trigger Input Jack 2.
- :
- rim 6** Rim switch input for Trigger Input Jack 6.
- Pad 7** Pad input for Trigger Input Jack 7.
- rim 7** Rim switch input for Trigger Input Jack 7.
- open** Pad input (when the hi-hat controller is not fully closed) for Trigger Input Jack 8.
- rimOpen** Rim switch input (when the hi-hat controller is not fully closed) for Trigger Input Jack 8.
- close** Pad input (when the hi-hat controller is fully closed) for Trigger Input Jack 8.
- rimCls** Rim switch input (when the hi-hat controller is fully closed) for Trigger Input Jack 8.
- footCl** Event when the hi-hat controller is depressed for Trigger Input Jack 8.
- splash** Splash event for the hi-hat controller for Trigger Input Jack 8.

Pad 9 Pad input for Trigger Input Jack 9.

Pad 10 Pad input for Trigger Input Jack 10.

- * According to the setting in the Utility Mode's [1-1. Learn Mode], the input source can be assigned by hitting the pad.
- * Monaural pads do not have a rim switch function.

② Layer Number

[Range] 1, 2, -

When 2 layers are used, use this setting to select which layer ("1" or "2") will be set.

When only 1 voice is set, "--" will appear and you will not be able to switch.

- * Use the [1-1. Voice] display to set whether 2 layer or 1 voice will be used.

If the same MIDI note number is set to more than one pad within the same drum kit, the lowest numbered Trigger Input Jack will take priority. Regardless of which pad is struck, the same voice (setting) will be delivered.

1-1. Voice

This function assigns the voice (drum voice) ③ for each input source ①. Two voices ② can be assigned for simultaneous delivery to 1 input source (when the pad is hit once).

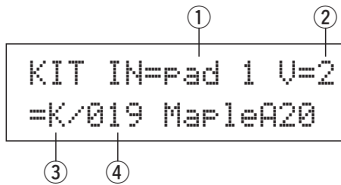

① IN (Input Source)

② Layer Number

Assigns the input source and layer for the setting. (Refer to P. 16)

Sets whether 2 layer or 1 voice will be used in this display. Only "1" or "2" can be selected in the Layer Number.

③ Voice Category

Selects the drum voice category that will be delivered by Layer 2 of Input Source ①.

Each of the following characters indicates a drum voice category.

- K: Acoustic Kick
- k: Electric Kick
- S: Acoustic Snare
- s: Electric Snare
- T: Acoustic Tom
- t: Electric Tom
- C: Cymbal
- H: Hi-hat
- P: Percussion
- E: Effect 1
- e: Effect 2
- L: Drum Loop
- M: misc. voices

④ Voice Number Voice Name

Selects the assigned voice. The Voice Number (1-127) and Voice Name will be displayed. When 2 Layer is selected, "*" will be displayed next to the Voice Name.

When "0" is selected, "NoAssignment" will be displayed in place of the Voice Name and no sound will be delivered.

- * Refer to the [Drum Voice List] (P. 38).

1-2. Volume, Pan

This function sets the Volume ③ and Pan ④ (the position in the stereo field) for each drum voice that is delivered by each layer ② of the input source ①.

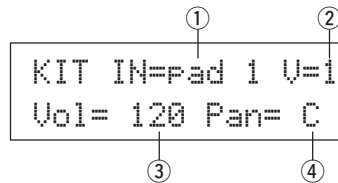

① IN (Input Source)

② Layer Number

Assigns the input source and layer for setting. (Refer to P. 16)

③ Vol (Volume)

[Range] 0-127

④ Pan

[Range] L64 to C to R64

1-3. Tuning

This function sets the pitch for each drum voice that is delivered by each layer ② of the input source ①.

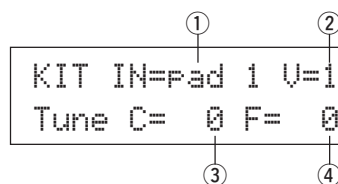

① IN (Input Source)

② Layer Number

Assigns the input source and layer for setting. (Refer to P. 16)

③ Tune C (Tune Coarse)

[Range] -24 to 0 to +24

Tuning can be set increments of a half step.

④ Tune F (Tune Fine)

[Range] -64 to 0 to +63

Tuning can be set increments of approximately 1.17 cents.

Drum Kit Voice Edit Mode

1-4. Layer Balance

When a drum voice is made up of 2 layers (a single voice consisting of 2 voice waves), this function sets the volume balance between the 2 layers that are delivered by each layer ② of the input source ①.

* When only a 1 layer voice is set, this setting will be ignored.

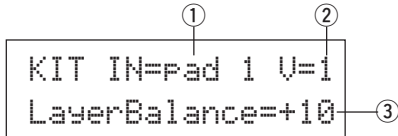

① **IN (Input Source)**

② **Layer Number**

Assigns the input source and layer for the setting. (Refer to P. 16)

③ **LayerBalance (Layer Balance)**

[Range] -64 to 0 to +63, ----

Sets the volume balance between 2 layers.

* When the drum voice has only 1 layer "----" will appear in the display and settings cannot be carried out.

1-5. Decay, Cutoff Frequency

This function sets the drum voice decay, the filter's cutoff frequency and adjusts the tone of each voice that is delivered by each layer ② of the input source ①.

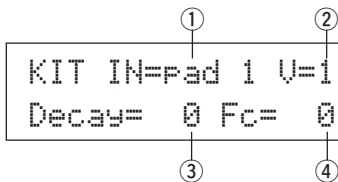

① **IN (Input Source)**

② **Layer Number**

Assigns the input source and layer for the setting. (Refer to P. 16)

③ **Decay**

[Range] -64 to 0 to +63

Positive values will produce a clearer sound.

④ **Fc (Cutoff Frequency)**

[Range] -64 to 0 to +63

A positive value will produce a brighter sound, negative values will produce a rounder sound.

1-6. Note Number

This function sets the MIDI note number for each layer ② that is transmitted when a signal is received from the input source ①.

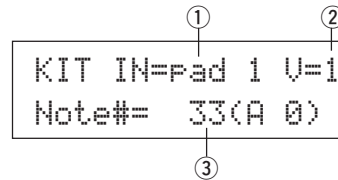

① **IN (Input Source)**

② **Layer Number**

Assigns the input source and layer for the setting. (Refer to P. 16)

③ **Note# (MIDI Note Number)**

[Range] 0-127 (C-2 to G8)

Sets the MIDI note number. The note number and voice name will be displayed.

* When the selected MIDI note number has already been assigned to another input source, "*" will be displayed next to "Note#=".

1-7. Channel, Gate Time

This function sets the MIDI transmit channel and gate time (the length of time from key on to key off) for the MIDI note on data of each layer ② that is transmitted when a signal is received from the input source ①.

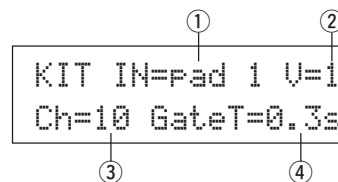

① **IN (Input Source)**

② **Layer Number**

Assigns the input source and layer for the setting. (Refer to P. 16)

③ **Ch (MIDI Channel)**

[Range] 1-16

④ **GateT (Gate Time)**

[Range] 0.0s - 9.9s

2. Input Common Parameters

This sub-mode sets the common settings between 2 layers for voice parameters of each pad's input source.

The Input Common Parameters sub-group is divided into the following 8 pages.

2-1. Cross Fade	19
2-2. Reverb Send	19
2-3. Alternate Group, Key Assign Mode	19
2-4. Hold Mode	20
2-5. Key Off Enable	20
2-6. Function	20
2-7. Pad Song	20
2-8. Rim to Pad	21

Select the Input Source for editing

In the Input Common Parameters edit display, first it is necessary to select the input source ① for editing. (Refer to page 16 on how to select the input source.)

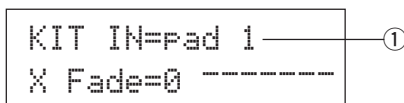

However, the same as in Voice Parameters, "If the same MIDI note number is set to more than one pad within the same drum kit, the lowest numbered trigger input jack will take priority. Regardless of which pad is struck, the same voice (setting) will be delivered." So, when the setting is invalid in edit displays [2-1. Cross Fade] – [2-5. Key Off Enable], the following display will appear and edits cannot be carried out.

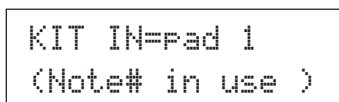

2-1. Cross Fade

This function sets the velocity (volume) cross fade between the 2 layer voices delivered by the input source ①.

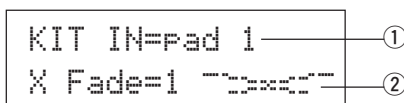

① IN (Input Source)

Assigns the Input Source for setting. (Refer to the display shown above.)

② j (Cross Fade Type)

[Range] 0-9

Selects the cross fade type ("1" to "9"). The conversion graph will appear to the right of the type number.

If this parameter is set to "0", the cross fade function will not be valid.

2-2. Reverb Send

This function sets the reverb send level ② for the voice (layer 1, 2) delivered by the input source ①.

* The actual reverb send level will be determined by multiplying the level set here with the level set in [5-2. Drum Reverb Send] (P. 23).

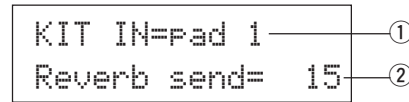

① IN (Input Source)

Assigns the input source for the setting. (Refer to P. 16)

② Reverb send (Reverb Send Level)

[Range] 0-127

2-3. Alternate Group, Key Assign Mode

This function sets the Alternate Group and Key Assign Mode for the voice (layer 1, 2) delivered by the input source ①.

Alternate Group: This is a group of voices assigned to the same group number that should not be delivered at the same time. For example, by assigning an open hi-hat with a closed hi-hat to the same group number, the open hi-hat sound will be canceled once the closed hi-hat sound is delivered.

Key Assign Mode: This defines the sound output rules when multiple voices that are assigned to the same MIDI note number are simultaneously delivered.

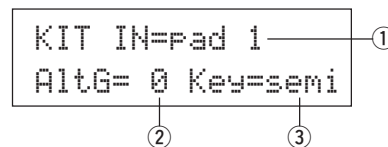

① IN (Input Source)

Assigns the input source for the setting. (Refer to P. 16)

② AltG (Alternate Group)

Voices that are assigned to the same MIDI note number that you do not want to be delivered simultaneously. If this parameter is set to "0" there will be no truncation.

* Some alternate group voices like Hi-Hat, etc., are preset in the voices.

③ Key (Key Assign Mode)

This defines the sound output rules when multiple voices that are assigned to the same MIDI note number are simultaneously delivered.

poly: There are no limits to the number of voices delivered at once.

semi: Up to 2 voices for this note number can be produced at one time. When a 3rd voice is triggered, one of the first 2 voices will be truncated.

mono: One voice can be delivered at one time, the previous voice will be truncated.

high: One voice can be delivered at one time, the previous voice will be truncated. However, even if the maximum number of 32 notes is exceeded, the note number selected here will not be truncated.

Drum Kit Voice Edit Mode

2-4. Hold Mode

Sets the Hold Mode for the voice (layer 1, 2) delivered by input source ①.

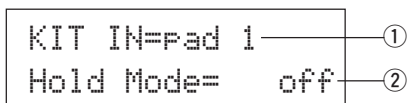

① IN (Input Source)

Assigns the input source for the setting. (Refer to P. 16)

② Hold Mode

on: Each time the pad is hit either a MIDI key on or MIDI key off event will be transmitted in succession.

off: Normal operation. When a pad is hit, only a MIDI key on event will be transmitted (after the decay time is up, key off will be transmitted automatically).

* If this function is set to “on”, it is recommended that you use the “key=high” setting in [2-3. Alternate Group, Key Assign Mode].

2-5. Key Off Enable

This function decides whether or not to recognize MIDI key off messages for the voice (layer1, 2) delivered by the input source ①.

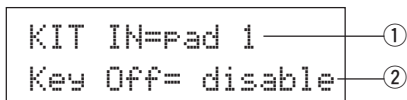

① IN (Input Source)

Assigns the input source for the setting. (Refer to P. 16)

② Key Off

enable: Recognizes key off.

disable: Does not recognize key off.

* When this function is set to “disable”, some voices may sound continuously. Press the [SHIFT] plus [VOICE] buttons to stop voices sounding.

2-6. Function

Along with the voice, this function can be used to control other functions ② according to the trigger from the input source ①.

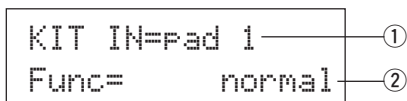

① IN (Input Source)

Assigns the input source for the setting. (Refer to P. 16)

② Func (Function)

Selects the function that is controlled by the trigger input.

normal: Normal operation.

pad song: Controls playback of the pad song*.

click on/off: Switches the click sound on/off.

inc drumkit: Increases the value of the drum kit number by 1 (increment).

dec drumkit: Decreases the value of the drum kit number by 1 (decrement).

trig bypass: Switches the trigger bypass function on/off (P. 28).

start/stop: Controls playback of the main song*.

main song: The main song is the selected in the Drum Kit Play mode, and is controlled from the panel (of MIDI/TO HOST jack).

pad song: According to this setting, playback of the pad song will be controlled by the trigger input. The pad song can be played independently of the main song. Also, up to 3 pad songs can be played along with main song simultaneously.

* Refer to the [2-7. Pad Song] for more information on setting the Pad Song.

* When 3 pad songs have already been selected in another input source, the “pad song” will not be displayed (“-----” is displayed).

2-7. Pad Song

This function contains settings for the pad song.

These settings are affective when a trigger from the input source ①, which is set in [2-6. Function], controls playback of the pad song.

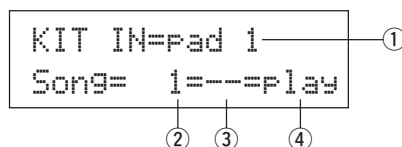

① IN (Input Source)

Assigns the input source for the settings (Refer to P. 16).

② Song Number

Assigns the song number (1-127) that is assigned to the pad song.

③ Repeat Playback

rr: Repeats playback of the song (when the song reaches the end it will start again from the beginning, continuously).

--: Normal playback.

④ Playback Mode

play: When a pad is hit, playback of the assigned pad song will start/stop.

chse: When the pad is hit, one measure of the assigned pad song will start playback then pause.

ctof: When the pad is hit, playback of the assigned pad song will start/stop. However, if the pad song is set to “ctof” the pad song will stop when another pad song with the “ctof” setting is started. This function allows only one “ctof” pad song to be played at a time.

- * Only data for MIDI channels 7, 8, 9, 10 is played back with the pad song.
- * If the Pad Song's tempo or voices are irregular, re-select the Drum Kit.
- * The following restrictions prevent overlapping of the main song and MIDI channels.
 - The first pad song in the drum kit will be transmitted on the MIDI channel number that is determined by subtracting "4" from the original MIDI channel number.
 - The second pad song in the drum kit will be transmitted on the MIDI channel number that is determined by adding "4" from the original MIDI channel number.
 - The third pad song in the drum kit will be transmitted after the MIDI channel is converted as follows.
 The original MIDI channel → MIDI transmit channel
 7 → 15, 8 → 16, 9 → 1, 10 → 2.

2-8. Rim To Pad

This function is only in affect when the input source ① is from a rim switch.
 When the rim is hit, pad events triggered from the same pad (trigger input jack) can be simultaneously transmitted with rim switch events.
 According to this setting, the pad can be triggered at the same time as the snare's rim shot.

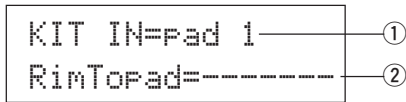

① **IN (Input Source)**
 Assigns the input source for the setting. (Refer to P. 16)
 * Selects the rim switch source.

② **RimToPad (Rim to Pad)**
 Sets the event that is transmitted when the rim is hit.
disable: Only transmits rim switch event.
enable: Transmits rim switch event and pad event.
 * When an input other than the rim switch is selected for the input source, "-----" will be displayed and settings can not be carried out.

3. Reverb Parameters

This function sets the internal reverb effect of the DTXPRESS. The reverb parameters are divided into the following 2 pages.

- 3-1. Reverb Type, Time 21
- 3-2. Reverb Master Return 21

3-1. Reverb Type, Time

Sets the type of reverb effect and reverb time for each drum kit.

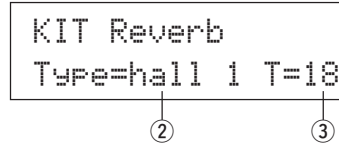

① **Type (Reverb Type)**

- Sets the reverb type.
- none*: No reverb (the same as thru).
 - hall 1*: Simulates reverb in a small hall.
 - hall 2*: Simulates reverb in a large hall.
 - room 1*: Simulates reverb in a small room.
 - room 2*: Simulates reverb in a large room.
 - room 3*: Simulates reverb in a room with a high ceiling.
 - stage 1*: Simulates playing on a large stage.
 - stage 2*: Simulates playing on a small stage.
 - Plate*: Simulates steel plate reverb.
 - white*: A special short reverb effect.
 - tunnel*: Simulates the reverb of a tunnel.
 - bsemnt*: Simulates the reverb of a basement.

② **T (Reverb Time)**

[Range] 0-69
 Sets the reverb time.
 This function can be used to change the characteristic of the reverb's sound.

3-2. Reverb Master Return

This function sets the signal return level from the reverb effect for every drum kit. By setting the level, you can adjust the reverb effect of the entire DTXPRESS system.

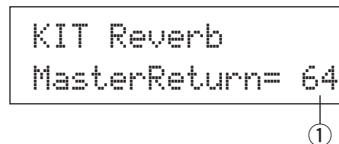

① **MasterReturn (Master Return)**

[Range] 0-127

Drum Kit Voice Edit Mode

4. Setup

When a drum kit is selected, this function copies MIDI transmit data settings and drum kit voice settings.

The Setup sub-group is divided into the following 3 pages.

- 4-1. Program Change, Bank Select 22
- 4-2. Volume, Pan 22
- 4-3. Drum Kit Voice Copy 22

4-1. Program Change, Bank Select

When a drum kit is selected, this function sets the MIDI Program Channel Number ③, the Bank Select MSB ④ and LSB ⑤ that will be transmitted.

This can be set ② for each MIDI channel ①.

By switching the drum kit, you can change the voice in an external MIDI device.

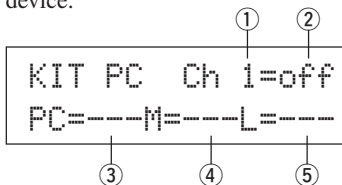

- ① **MIDI Channel**
[Range] Ch1–Ch16
- ② **Program Change Transmit On/Off**
on: Transmits.
off: Does not transmit.
- ③ **PC (Program Change Number)**
[Range] 1-128
- ④ **M (Bank Select MSB)**
- ⑤ **L (Bank Select LSB)**
[Range] 0-127

Sets the bank for when the drum kit is switched. The bank will be assigned with the 2 values set in Bank Select MSB and LSB.

* Refer to the Voice List and MIDI Data Format, etc. of the external MIDI device you are using for more information on Bank Select MSB, LSB.

4-2. Volume, Pan

When a drum kit is selected, this function sets the MIDI Control Change Volume ③ and the Pan ④ that will be transmitted.

This can be set ② for each MIDI channel ①.

By switching the drum kit, you can change the voice volume and pan in an external MIDI device.

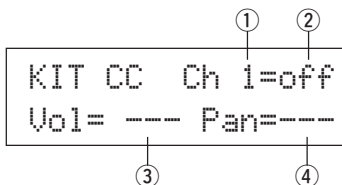

- ① **MIDI Channel**
[Range] Ch1-Ch16
- ② **Control Change Transmit On/Off**
on: Transmits
off: Does not transmit
- ③ **Vol (Volume)**
[Range] 1-128
Sets the Volume Control Change data value that will be transmitted.
- ④ **Pan**
[Range] 0-127
Sets the Pan Control Change data value that will be transmitted.

4-3. Drum Kit Voice Copy

This function copies all data settings in [1-1. Voice] – [2-7. Pad Song] from the Input Source ① to another Input Source ②.

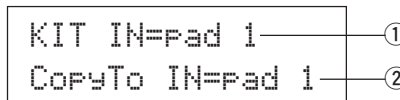

! When the Drum Kit Voice Copy operation is carried out, the Drum Kit Voice data in the destination Input Jack will be replaced with the data of the copy source.

- ① **IN (Input Source Copy Source)**
Sets the input source of the copy source. (Refer to P. 16)
- ② **CopyTo IN (Input Source Copy Destination)**
Sets the input source of the copy destination. (Refer to P. 16)

Procedure

1. In the display shown above, assign the input source for the copy source and copy destination, press the [SAVE/ENT] button.

The following display will appear asking for confirmation before the copy operation is carried out.

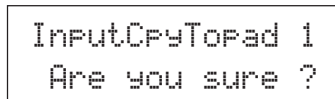

2. Press the [SAVE/ENT] or [VALUE+] button, the copy operation will be carried out.

* Press the [VALUE-] button to cancel the copy operation.

When the copy operation is complete, "Complete!" will appear.

5. Drum Kit Common Parameters

This function sets the common settings for the entire drum kit. The Drum Kit Common Parameters are divided into the following 5 pages.

5-1. Volume	23
5-2. Drum Reverb Send	23
5-3. Hi-Hat Sensitivity	23
5-4. Song Select	23
5-5. Drum Kit Name	23

5-1. Volume

Sets the overall volume for the drum voice.

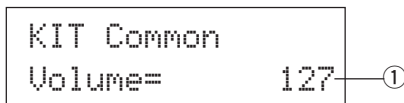

- ① **Volume**
[Range] 0-127

5-2. Drum Reverb Send

Sets the overall reverb send level of the drum voice.

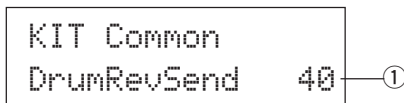

- ① **DrumRevSend (Drum Reverb Send Level)**
[Range] 0-127

The actual reverb send level will be determined by multiplying the reverb send level set in [2-2. Reverb Send] (P. 19) with the value set here.

5-3. Hi-Hat Sensitivity

Sets the foot controller sensitivity connected to HI-HAT CONTROL jack on the rear panel.

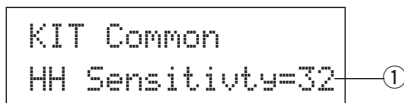

- ① **HH Sensitivity**
[Range] 0-63
Larger values provide higher sensitivity.

5-4. Song Select

This parameter allows you to switch the main song ① at the same time the drum kit is switched.

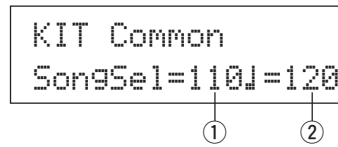

- ① **Song Select (Song Number)**

[Range] —, 1-127

Assign the song number to select the song for playback. The song will not be switched if the setting is set to “---”.

- ② **J (Tempo)**

[Range] —, 30-300

Assign the tempo that will be used. If “---” is set, the tempo will not change .

5-5. Drum Kit Name

Changes the drum kit name that is currently selected for editing.

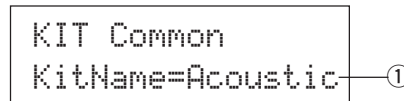

- ① **KitName (Drum Kit Name)**

Procedure

1. In the display shown above, use the [SEL◀]/[SEL▶] buttons to move the cursor to the character you want to change.
2. Use the [VALUE-]/[VALUE+] buttons to select the alphabet, number or symbol.
3. Repeat steps 1 and 2 above to create the Drum Kit Name using a maximum of 8 characters.

- The available characters to choose from are (in order):

```
space
!"#$%&'()*+,-./0123456789:;<=>?@
ABCDEFGHIJKLMNOPQRSTUVWXYZ[^\`~
abcdefghijklmnopqrstuvwxyz{|}~
```

Song Job Mode

This function edits the **User Song (No. 97-128)** that is currently selected.

■ Entering the Song Job Mode

Press the [SONG] button on the front panel.

Once the Song Job Mode is entered, the main page (Tempo, Repeat Playback) shown below will be displayed.

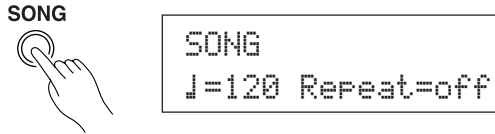

* Double-click the [SONG] button to enter the Song Job Mode and the [β. Clear Song] display will appear.

■ What's in the Song Job Mode

The Song Job Mode is divided into the following 9 pages.

1. Tempo, Repeat Playback	24
2. Program Change, Bank Select	24
3. Volume, Pan	25
4. Song Copy	25
5. Quantize	25
6. Clear Track	26
7. Merge Track	26
8. Clear Song	26
9. Song Name	26

Procedure

- Before editing, it is necessary to select the User Song (No. 97-128) you want to edit in the Drum Kit Play Mode's [Drum Kit & Song] display or [Song & Mute] display.
- Press the [SONG] button to enter the Song Job Mode.
 - * If the [SONG] button is pressed when a preset song is already selected, "CAN'T EDIT PRESET SONG" will appear and the Song Job Mode cannot be entered.
- Use the [PAGE▲]/[PAGE▼] buttons to display the page you want to edit.
 - * If the Utility Mode's [1-4. Jump To Recent Page] (P. 28) parameter is set to "on", The DTXPRESS will display the page last edited when entering the Song Job Mode.
- Use the [SEL◀]/[SEL▶] buttons to move the cursor to the parameter you want to edit. The parameter will flash.
 - * If there is only one parameter, it is not necessary to move the cursor.
- Use the [VALUE-]/[VALUE+] buttons to set the parameter's value or ON/OFF setting.

Any settings made in the Song Job Mode will directly change the settings in the memory of the DTXPRESS. It is not necessary to use the Store Operation.

1. Tempo, Repeat Playback

This function changes the tempo (rewrites the tempo information in the song's header) and sets the repeat playback of the user song.

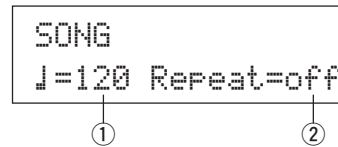

① J (Tempo)

[Range] 30-300

② Repeat (Repeat Playback)

[Range] off, on

If this is set to "on", the user song will repeat playback.

If this is set to "off", the user song will play normally.

2. Program Change, Bank Select

This function changes the voices that will be used for each MIDI channel in the user song (rewrites the voice information in the song's header). This program change will be transmitted when a song is selected and when song playback is stopped.

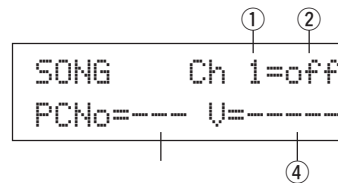

① MIDI Channel

[Range] Ch1-Ch16

② Program Change Transmit On/Off

on: Transmits.

off: Does not transmit.

③ PCNo (Program Change Number)

[Range] 1-128

④ V (Bank Select)

[Range] melody, drumV

Sets the bank that will be switched.

melody: Transmits the melody voice program change (MSB=0).

drumV: Transmits the drum voice program change (MSB=127).

3. Volume, Pan

This function changes the volume and pan settings for each MIDI channel in the user song (rewrites the Voice information in the song's header). This control change will be transmitted when a song is selected and when song playback is stopped.

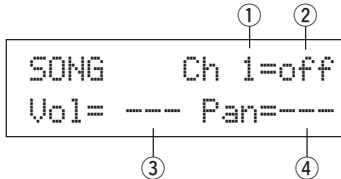

① **MIDI Channel**

[Range] Ch1-Ch16

② **Control Change transmit On/Off**

on: Transmits.

off: Does not transmit.

③ **Vol (Volume)**

[Range] 0-127

④ **Pan**

[Range] 0-127

4. Song Copy

This function copies the assigned song ① to the user song that is currently selected.

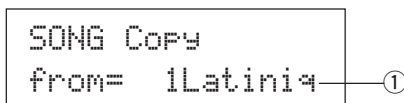

When the Song Copy operation is carried out, all data in the User Song that is currently selected will be replaced with data of the copy source.

① **from (Copy Source)**

[Range] 1-127

Sets the song that is the copy source. The song number and name will be displayed. A preset song or a user song can be assigned.

Procedure

1. Assign the Copy Source Song on the display shown above, press the [SAVE/ENT] button. The following display will appear asking for confirmation before the copy operation is carried out.

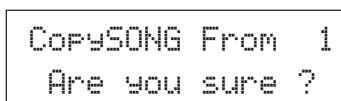

2. Press the [SAVE/ENT] or [VALUE+] button, the copy operation will be carried out.

- * Press the [VALUE-] button to cancel the copy operation.
- * During song playback, the copy operation cannot be carried out. "ERROR SEQ is Running" will appear. Stop the song and try the copy operation again.
- * If memory is insufficient when in the copy operation, "ERROR Memory Full" will appear. Clear any unnecessary user songs and try the copy operation again.

When the copy operation is complete, "Complete!" will appear.

5. Quantize

This function quantizes each track ① of the user song to the accuracy ② defined here.

quantize: When the timing of the sequence data that was recorded is inaccurate, this function is used to correct the timing. The accuracy for correcting can be assigned using note lengths.

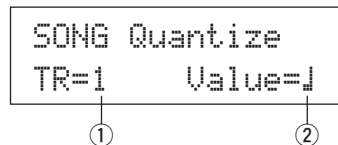

When the Quantize operation is carried out, all data in the assigned track of the currently selected user song will be replaced.

① **TR (Specified Track)**

Assigns the track ("1" or "2") to be quantized.

② **Value (Quantize Accuracy)**

[Range] ↓ quarter note, ↓ quarter note (triplet),
 ↓ eighth note, ↓ eighth note (triplet),
 ↓ sixteenth note, ↓ sixteenth note (triplet)

Procedure

1. Set the track and the quantize accuracy on the display shown above, press the [SAVE/ENT] button. The following display will appear asking for confirmation before the quantize operation is carried out.

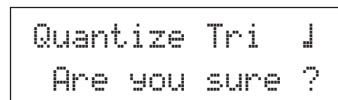

2. Press the [SAVE/ENT] or [VALUE+] button, the quantize operation will be carried out.

- * Press the [VALUE-] button to cancel the quantize operation.
- * During song playback, the quantize operation cannot be carried out. "ERROR SEQ is Running" will appear. Stop the song and try the quantize operation again.
- * If memory is insufficient when in the quantize operation, "ERROR Memory Full" will appear. Clear any unnecessary user songs and try the quantize operation again.

When the quantize operation is complete, "Complete!" will appear.

Song Job Mode

6. Clear Track

This function clears all data in the assigned track ① in the user song.

```
SONG Clear Track
Track=1
```

① TR (Specified Track)

Assigns the track ("1" or "2") to be cleared.

Procedure

1. Assign the track you want to clear on the display shown above, press the [SAVE/ENT] button. The following display will appear asking for confirmation before the clear track operation is carried out.

```
Clear Track 1
Are you sure ?
```

2. Press the [SAVE/ENT] or [VALUE+] button, the clear track operation will be carried out.
 - * Press the [VALUE-] button to cancel the clear track operation.
 - * During song playback, the clear track operation cannot be carried out. "ERROR SEQ is Running" will appear. Stop the song and try the clear track operation again.

When the Clear Track operation is complete, "Complete!" will appear.

7. Merge Track

This function merges (mixes) the sequence data in tracks 1 and 2 of the user song to track 1.

```
SONG Merge Track
Are you sure ?
```

Procedure

1. Press the [SAVE/ENT] button on the display shown above, the merge operation will be carried out. When the Merge Track operation is complete, "Complete!" will appear.
 - * If memory is insufficient when in the merge operation, "ERROR Memory Full" will appear. Clear any unnecessary user songs and try the merge operation again.
 - * During song playback, the merge operation cannot be carried out. "ERROR SEQ is Running" will appear. Stop the song and try the merge operation again.

8. Clear Song

This function clears the sequence data in tracks 1 and 2 of the user song.

```
SONG Clear Song
Are you sure ?
```

Procedure

1. Press the [SAVE/ENT] button on the display shown above, the clear song operation will be carried out. When the Clear Song operation is complete, "Complete!" will appear.
 - * During song playback, the clear song operation cannot be carried out. "ERROR SEQ is Running" will appear. Stop the song and try the clear song operation again.

9. Song Name

This function changes the user song name that is currently selected (for editing).

```
SONG
SngName=no name
```

① SngName (Song Name)

Procedure

1. Use the [SEL◀]/[SEL▶] buttons to move the cursor to the character you want to change on the display shown above.
2. Use the [VALUE-]/[VALUE+] buttons to select the alphabet, number or symbol.
3. Repeat steps 1 and 2 above to create the User Song Name using a maximum of 8 characters.

- The available characters to choose from are (in order):

```
space
!"#$%&'()*+,-./0123456789:;<=>?@
ABCDEFGHIJKLMNPOQRSTUVWXYZ[^\_`
abcdefghijklmnopqrstuvwxyz{|}~
```

Utility Mode

This mode sets general parameters for the DTXPRESS system and MIDI.

■ Enter the Utility Mode

Press the [UTIL] button on the front panel.

Once the Utility Mode is entered, the System Group main page (LearnMode) shown below will be displayed.

UTIL



```
UT SYSTEM
LearnMode=allwys
```

* Double-click the [UTIL] button to enter the Utility Mode. The [4-1. Equalizer (EQ)] display will appear.

■ What's in the Utility Mode

The Utility Mode is divided into the 5 sub-groups listed below.

- 1. SYSTEM Group** (→P. 28)
Contains various settings that affect the entire DTXPRESS system.
- 2. MIDI Group** (→P. 29)
Contains various settings for the DTXPRESS' MIDI and TO HOST functions.
- 3. SEQ (Sequencer) Group** (→P. 32)
Contains various settings that apply to the DTXPRESS' sequencer (song).
- 4. TG (Tone Generator) Group** (→P. 34)
Contains various settings that apply to the DTXPRESS' tone generator.
- 5. MAP (Drum Map) Group** (→P. 35)
Used to edit the User Drum Map.

How to set...

- 1.** Press the [UTIL] button to enter the Utility Mode.
- 2.** Select the sub-mode.
 - Press the [UTIL] button to move to the next sub group's main page.
 - Use the [PAGE▲], [PAGE▼] buttons to move to page by page within the selected sub group. You can use these buttons to navigate through all of the pages (from the first System Group main page to the last MAP Group page).
- 3.** Use the [SEL◀], [SEL▶] buttons to move the cursor to the setting you want to change. The value will flash.
 - * If there is only one parameter, it is not necessary to move the cursor.
- 4.** Use the [VALUE-] and [VALUE+] buttons to set the parameter's value or ON/OFF setting.

Any settings made in the Utility Mode will directly change the memory settings of the DTXPRESS. There is no store function in this mode.

Utility Mode Function List

	Page
1. SYSTEM Group	28
1-1. Learn Mode	28
1-2. Trigger Bypass	28
1-3. Volume Mode	28
1-4. Jump to Recent Page	28
1-5. Hi-Hat Offset	29
1-6. Factory Set	29
2. MIDI Group	29
2-1. Bulk Dump	29
2-2. Channel 10 Program Change/ Channel Event Receive	30
2-3. Receive Program Change/ System Exclusive Messages	30
2-4. Program Change Table	31
2-5. MIDI Mode	31
2-6. Device Number, Local Control	31
2-7. MIDI Merge	31
2-8. Dump Interval	32
2-9. Send Hi-Hat Control	32
2-10. Host Thru Port	32
3. Sequencer Group	32
3-1. Click Voice	32
3-2. Click Tune	33
3-3. Click Note Number	33
3-4. MIDI Control	33
3-5. Count Switch	33
3-6. Sync Mode	33
3-7. Use Tempo	34
3-8. Click Mode	34
4. TG (Tone Generator) Group	34
4-1. Equalizer (EQ)	34
4-2. Tuning	34
4-3. Volume	34
4-4. Reverb Bypass	35
5. MAP (Drum Map) Group	35
5-1. Voice	35
5-2. Volume, Pan	36
5-3. Tuning	36
5-4. Layer Balance	36
5-5. Decay, Cutoff Frequency	36
5-6. Reverb Send	36
5-7. Alternate Group, Key Assign Mode	37
5-8. Key Off Enable	37
5-9. Map Copy	37

Utility Mode

1. SYSTEM Group

This sub-mode contains settings that relate to the overall DTXPRESS system. The group is divided into the following 6 pages.

- 1-1. Learn Mode 28
- 1-2. Trigger Bypass 28
- 1-3. Volume Mode 28
- 1-4. Jump to Recent Page 28
- 1-5. Hi-Hat Offset 29
- 1-6. Factory Set 29

1-1. Learn Mode

This function allows selection of the pad (trigger input) you want to edit by hitting the pad when you are editing in the Trigger Setup Edit mode or Drum Kit Edit mode. Also, MIDI key on input from the MIDI IN/TO HOST jack can be used to appoint the MIDI note number in the Utility mode's User Map Setting.

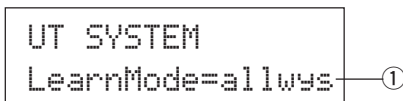

① LearnMode

- allwys:** Always appoints according to pad/key on input.
- shift:** Hitting a pad or key on input while holding the [SHIFT] button selects the pad or note.
- none:** Can't appoint according to pad/key on input.

1-2. Trigger Bypass

This function prohibits reception of pad signals from pads (the hi-hat controller too) connected to the DTXPRESS. You will not be able to produce voices or transmit MIDI data. The sequencer and tone generator will function normally.

HINT Use this function when you are setting your drum kit with trigger pickup devices, or when you do not want to accidentally make a sound during song playback.

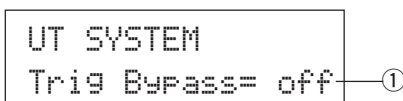

① Trig Bypass

- off:** Bypasses the trigger (does not receive).
- on:** The trigger functions normally (receives trigger).

1-3. Volume Mode

Sets the ACCOMP. VOL knob and CLICK VOL knob on the front panel.

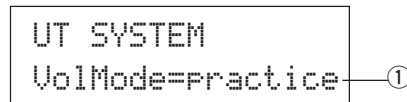

① VolMode (Volume Mode)

- **practice:** When set to the practice mode.
 - [ACCOMP. VOL]
Using the [ACCOMP. VOL] knob as is will adjust the volume of the song accompaniment.
Holding the [SHIFT] button while turning the knob will adjust the snare drum volume.
 - [CLICK VOL]
Using the [CLICK VOL] knob as is will adjust the volume of the metronome click.
Holding the [SHIFT] button while turning the knob will adjust the bass drum volume.
- **live:** When set to the Live mode.
 - [ACCOMP. VOL]
Using the [ACCOMP. VOL] knob as is will adjust the snare drum volume.
Holding the [SHIFT] button while turning the knob will adjust the cymbal volume.
 - [CLICK VOL]
Using the CLICK VOL knob as is will adjust the bass drum volume.
Holding the [SHIFT] button while turning the knob will adjust the volume of the drum's other instruments.

1-4. Jump to Recent Page

This function lets you display the page last selected in the previous edit of the Trigger Setup Edit mode and Drum Kit Edit mode.

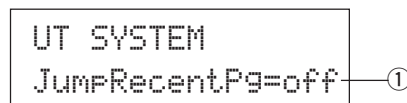

① JumpRecentPg (Jump to Recent Page)

- on:** The display page last selected in the previous edit will appear when you enter the Trigger Setup Edit, Drum Kit Edit, Utility and Song Job modes.
- off:** The main page of each mode will be displayed.

1-5. Hi-Hat Offset

This sets the value of the data sent by a foot controller connected to the HI HAT CONTROL jack on the rear panel. Set a + (plus) or – (minus) level.

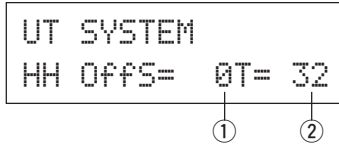

① HH OFFS (Hi-Hat Offset)

When a low data value is received from the foot controller, the voice will sound sooner. So, slightly pressing the foot controller will result in the voice sounding. In the case of the hi-hat controller, delicate adjustment of the controller's "closed" point is possible.

② T (Foot Splash Detect Time)

Sets the detect time for the foot splash. Large values make foot splashes easier to produce.

* Values too large will result in splashes being produced under normal hi-hat use.

1-6. Factory Set

This function replaces all internal settings in the DTXPRESS to their factory-set condition.



The Factory Set function will replace all internal settings in the DTXPRESS to their factory-set condition. Take care so as not to lose important data. Make sure any settings and user songs you want to keep have been saved to an external device such as the Yamaha MIDI Data Filer MDF3, etc. (→[2-1. Bulk Dump] (P. 29))

Procedure

1. Enter the display shown above, press the [SAVE/ENT] button. The following display will appear asking for confirmation before the Factory Set operation is carried out.

2. Once again, press the [SAVE/ENT] button to proceed with the operation.

2. MIDI Group

This sub-mode contains functions and settings for the MIDI and TO HOST jacks of the DTXPRESS. This group is divided into the following 10 pages.

2-1. Bulk Dump	29
2-2. Channel 10 Program Change/ Channel Event Receive	30
2-3. Receive Program Change/ System Exclusive Messages	30
2-4. Program Change Table	31
2-5. MIDI Mode	31
2-6. Device Number, Local Control	31
2-7. MIDI Merge	31
2-8. Dump Interval	32
2-9. Send Hi-Hat Control	32
2-10. Host Thru Port	32

* Please refer to the [MIDI Data Format] (P. 50) section for more information related to MIDI.

2-1. Bulk Dump

With the Bulk Dump operation, data stored in the DTXPRESS can be transmitted via the MIDI OUT or TO HOST jack.

① Fmt (Bulk Dump Format)

Selects the type of data to be transmitted with the Bulk Dump operation.

all data	: All the data in the DTXPRESS
system data	: Data set in the Utility mode (except User Map).
user map	: User Map data.
one drumkit	: Data for the currently selected Drum Kit.
all drumkit	: All User Drum Kit Data.
one trigger	: Data for the currently selected Trigger Setup.
all trigger	: All User Trigger Setup data
one song	: Data for the currently selected User Song.
all song	: All User Song data.

Procedure

1. After reading the [Connecting a MIDI Device] (Basic Guide : P. 12) or the [Connecting a Computer] (Basic Guide : P. 26) section, connect the external MIDI device or computer to the MIDI OUT or TO HOST jack on the DTXPRESS. Set the HOST SELECT switch.

Utility Mode

2. Select the type of bulk data (that will be sent) in the display shown above and press the [SAVE/ENT] button. The display shown below will appear.

```
BULK    all data
Are you sure ?
```

3. Press the [SAVE/ENT] or [VALUE+] button, the bulk dump will be carried out.

- * Press [VALUE-] to cancel the bulk dump. When the operation is complete, the LCD will display "Complete" as shown below.

```
Complete !
```

- * The device number must be set for bulk dumps [2-6. Device Number, Local Control] (P. 31)
- * Refer to the [MIDI Data Format] section (P. 50) for more information on bulk dump operations.

Receiving Bulk Data

DTXPRESS data stored in an external device can be sent back to the DTXPRESS' MIDI IN/TO HOST jack using Bulk Data Receive.

1. After reading the [Connecting a MIDI Device] (Basic Guide : P. 12) or the [Connecting a Computer] (Basic Guide : P. 26) section, connect the MIDI device or computer to the MIDI OUT jack/TO HOST jack on the DTXPRESS. Set the HOST SELECT switch.
2. With the sequencer (song, metronome) stopped, send bulk data from the external device.
3. When the DTXPRESS starts receiving data, the following screen will appear on the LCD.

```
BULK Receiving
Please wait...
```

4. When the DTXPRESS has completed receiving all the data, the following screen will appear on the LCD for a few seconds, then the screen will return to the original display (before receiving bulk data).

```
BULK Received.
```

- * Before receiving bulk data, it is necessary to match the device numbers (P. 31 [2-6]) of the DTXPRESS and the external device. It is also necessary to enable the DTXPRESS to receive exclusive messages (P. 30 [2-3]).

2-2. Channel 10 Program Change/Channel Event Receive

This enables or disables the DTXPRESS to receive program change messages/channel events through MIDI channel 10. Program change messages received or transmitted through channel 10 can be used to switch DTXPRESS drum kits.

It is necessary to set the receive parameter to "on" in this display in order to switch the DTXPRESS' drum kits from a song or an external MIDI device.

```
UT MIDI RECEIVE
10PC= on  10= on
```

① ②

① 10PC (Receive Program Change)

This enables or disables the DTXPRESS to receive program change messages through MIDI channel 10.

off: Does not receive.

on: Receives.

- * Even if the ① 10PC parameter is set to "on", program change messages from MIDI channel 10 will not be received in the following cases.

- If the ② 10 (receive channel event) parameter is set to "off"
- If the [2-3. Receive Program Change/System Exclusive Message's] ① PC (program change) parameter is set to "off".

② 10 (Receive Channel Event)

This enables or disables the DTXPRESS to receive MIDI channel messages through MIDI channel 10.

off: Does not receive.

on: Receives.

2-3. Receive Program Change/System Exclusive Messages

This enables or disables the DTXPRESS to receive program change messages/system exclusive messages from all MIDI channels.

```
UT MIDI RECEIVE
PC= on  SySEx= on
```

① ②

① PC (Receive Program Change)

off: Does not receive program change messages.

on: Receives program change messages.

② SySex (Receive System Exclusive Messages)

off: Does not receive system exclusive messages.

on: Receives system exclusive messages.

2-4. Program Change Table

Use this function to create a program change table (a list of program change numbers that correspond to drum kits).

A program change message received internally from the DTXPRESS or through channel 10 from an external MIDI device will select, according to the program change table, the drum kit corresponding to the kit number in the DTXPRESS.

```

UT MIDI PC TABLE
No=  1-> kit 56
  
```

① ②

① No (Program Change Number)

Sets the program change number (1-128).

When the program change number set in this parameter is received, the corresponding drum kit number that is set in the following “kit” parameter will be selected.

② kit (Drum Kit Number)

Sets the drum kit number (1-80).

If this parameter is set to “none” the DTXPRESS will not respond, even when a program change message is received.

- * When the drum kit is changed with the DTXPRESS, the program change set in this function will be transmitted through MIDI channel 10. However, when a program change number is not assigned, it will not transmit.
- * When the following [2-5. MIDI Mode] is set to GM, receiving program changes will be limited.

2-5. MIDI Mode

This sub-group contains settings related to the MIDI IN jack and TO HOST input jack that affect tone generator events.

```

UT MIDI SETUP
MIDI Mode=native ①
  
```

① MIDI Mode

native: Recognizes all program changes for the drum voice.

GM: Drum voice pan is reversed so you will hear the drums as if you are sitting in the audience, the hi-hat will be heard on the right side. The following drum voice program changes are recognized. 1, 2, 9, 17, 25, 26, 33, 41, 50

2-6. Device Number, Local Control

Sets the MIDI device number and local control.

```

UT MIDI SETUP
DevNo=ALLocl= on
  
```

① ②

① DevNo (Device Number)

Sets the MIDI device number (1-16).

Bulk dumps will be transmitted with this device number.

Only data corresponding to this device number will be recognized when received.

If this is set to “AL”, the device number will be “1” for transmitting data and data will be received from all device numbers.

② Locl (Local Control)

Switches Local Control ON or OFF.

off: MIDI signals triggered by the connected pads is disconnected from the DTXPRESS’ tone generator, there will be no sound produced by the DTXPRESS’ tone generator. The DTXPRESS will transmit MIDI signals from the MIDI OUT jack and TO HOST jack.

on: Normal operation. MIDI signals will be transmitted to the DTXPRESS’ tone generator as well as the MIDI OUT and TO HOST jacks.

2-7. MIDI Merge

Sets the MIDI Merge function ON or OFF. When this function is ON, data received from an external MIDI device connected to the MIDI IN jack will be mixed with internal MIDI data from the DTXPRESS and transmitted from the DTXPRESS’ MIDI OUT jack.

```

UT MIDI SETUP
Merge Output=off ①
  
```

① Merge Output (Merge Out)

on: Sends signals to the MIDI OUT jack.

off: Does not send signal to the MIDI OUT jack (internal operation only). Normal operation.



Connecting the MIDI IN/OUT jacks on a single device and setting MIDI Merge to “on” will result in a signal loop that may cause notes to sound (play) continuously.

Utility Mode

2-8. Dump Interval

This sets the length of intervals between the packets of MIDI data sent by the DTXPRESS Bulk Out function. The intervals can be adjusted to the capacity of the external receiving MIDI device to prevent data overflow.

```
UT MIDI SETUP
DumpInterval=100
```

- ① **DumpInterval (Dump Interval)**
[Range] 50, 100, 150, 200, 250, 300 (in msec.)

2-9. Send Hi-Hat Control

This sets whether or not hi-hat controller events will be transmitted from the MIDI OUT jack or TO HOST jack.

```
UT MIDI SETUP
Send HH Ctrl= on
```

- ① **Send HH Ctrl (Send Hi-Hat Control)**
on: Sends data to the MIDI OUT jack and TO HOST jack.
off: Does not send data to the MIDI OUT jack and TO HOST jack.
* This setting does not affect internal operating data for the hi-hat controller.

2-10. Host Thru Port

This enables the DTXPRESS to transmit multi-port type messages received from the TO HOST jack. Only messages corresponding to the set port number will be sent via MIDI.

- * This setting only has affect when the TO HOST switch is set to a position other than "MIDI".

```
UT MIDI SETUP
Host Thru Port=1
```

- ① **Host Thru Port**
Assigns the Port Number (1-8).

3. Sequencer Group

This sub-mode contains settings that relate to the sequencer (song). This group is divided into the following 8 pages.

3-1. Click Voice	32
3-2. Click Tune	33
3-3. Click Note Number	33
3-4. MIDI Control	33
3-5. Count Switch	33
3-6. Sync Mode	33
3-7. Use Tempo	34
3-8. Click Mode	34

3-1. Click Voice

This function sets each of the 3 click voices used for the click sound. Drum voices are assigned.

```
UT SEQ Click= hi
=P/053 MtBel
```

- ① **Click (Click Voice)**
Select and set the Click Voice for the click sound.
hi: Used for the click at the beginning of the measure.
mid: Used for quarter note beats.
lo: Used for other clicks for notes of smaller quantization.
- ② **Voice Category**
[Range] K, k, S, s, T, t, C, H, P, E, e, L, m
Sets the voice to be used for the Click Voice selected in step ①
Click, select a drum voice category.
Refer to Drum Kit Voice Edit Mode's [1-1. Voice] (P. 17).
- ③ **Voice Number Voice Name**
[Range] 0, 1-127
Selects the voice that will be assigned. The Voice Number (1-127) and Voice Name will be displayed.
If this parameter is set to "0", "NoAssign" will appear on the display and sound will not be produced.
* Refer to the [Drum Voice List] (P. 38).

3-2. Click Tune

This sets the pitch for each of the 3 Click Voices.

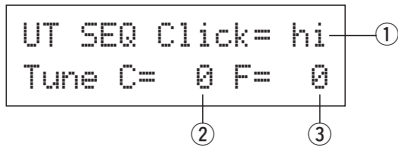

① Click (Click Voice)

Selects the Click Voice. (The same Click Voice selected in function 3-1.)

② Tune C (Tune Coarse)

[Range] -24 to 0 to +24.

The Click Voice selected in step ① will be tuned in increments of a half-step.

③ Tune F (Tune Fine)

[Range] -64 to 0 to +63.

The Click Voice selected in step ① will be tuned in increments of about 1.17 cents.

3-3. Click Note Number

Sets the MIDI Note Number for each of the 3 Click Voices.

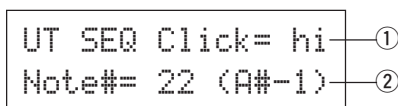

① Click (Click Voice)

Selects the Click Voice. (The same Click Voice selected in function 3-1.)

② Note # (MIDI Note Number)

[Range] off, 1-127 (—, C#-2 to G8)

Sets the MIDI note number. The note number and note name will be displayed.

If this is set to “off”, the DTXPRESS will produce sound however; key on messages will not be transmitted.

* Refer to the preset drum kit's [Drum Voice List] for the voice assignment of each MIDI note number.

3-4. MIDI Control

This enables or disables the DTXPRESS to transmit or receive system real-time messages (start/continue/stop).

When this function is enabled, you can control an external sequencer or rhythm machine from the DTXPRESS. Control of the DTXPRESS from an external sequencer or rhythm machine is also possible.

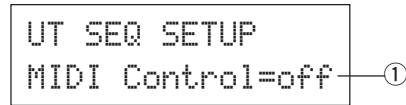

① MIDI Control

on: Transmits and receives the following system real-time messages.

- Transmits timing clock (F8) (transmit only)
- Transmits and receives start, stop, and continue (FA, FB, FC)

off: Does not transmit or receive system real-time messages.

3-5. Count Switch

This function turns the 2 bar countdown before the song starts playback, on or off.

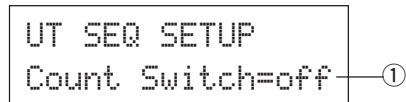

① Count Switch

on: After a 2 bar countdown, the song will start playback.

off: No countdown, the song will start playback immediately.

3-6. Sync Mode

This function synchronizes the DTXPRESS sequencer's clock with the clock of an external device.

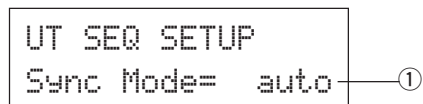

① Sync Mode

int: Movement is determined by the DTXPRESS' internal clock.

ext: Movement is determined by the clock of an external device received via the MIDI IN/TO HOST jacks.

auto: If a timing clock (F8) is received via the MIDI IN/TO HOST jack the external clock will be used. If a timing clock (F8) is not received the internal clock will be used.

Utility Mode

3-7. Use Tempo

This function sets the tempo of a song to either change each time to its default tempo, or remain unchanged at the currently set tempo when the song is switched.

```
UT SEQ SETUP
Use Tempo= song
```

① Use Tempo

song: Changes the tempo of the song to its default tempo when the song is switched.

global: The tempo remains unchanged at the currently set tempo when the song is switched.

3-8. Click Mode

This sets whether or not the click voice will automatically sound during song playback.

```
UT SEQ SETUP
ClickMode=manual
```

① ClickMode (Click Mode)

manual: The [CLICK] button will control on/off operation of the click sound.

sync: The click will sound during song playback, but will not sound when the song is stopped. The [CLICK] button can also be used to control on/off operation of the click sound.

4. TG (Tone Generator) Group

This sub-mode contains settings for the DTXPRESS' tone generator. This group is divided into the following 4 pages.

4-1. Equalizer (EQ)	34
4-2. Tuning	34
4-3. Volume	34
4-4. Reverb Bypass	35

4-1. Equalizer (EQ)

Sets the Master Equalizer (2-band shelving type).

```
UT TG MASTER
EQ Lo=+ 6 Hi=+ 0
```

① EQ Lo (Low Gain)

[Range] +0 to +12 (dB)

② EQ Hi (High Gain)

[Range] +0 to +12 (dB)

4-2. Tuning

This function sets the master tuning of the tone generator.

```
UT TG MASTER
Tune C= 0 F= 0
```

① Tune C (Tune Coarse)

[Range] -24 to 0 to +24

Tuning can be set in increments of a half step.

② Tune F (Tune Fine)

[Range] -64 to 0 to +63

Tuning can be set in increments of about 1.17 cents.

4-3. Volume

This function sets the overall volume level of the tone generator.

```
UT TG MASTER
Volume= 110
```

① Volume

[Range] 0-127

4-4. Reverb Bypass

This function decides whether to bypass the system effect's reverb or not.



① ReverbBypass (Reverb Bypass)

- off: Does not bypass (functions). Normal operation.
- on: Bypasses. Reverb will not be applied to the voice.

5. MAP (Drum Map) Group

This sub-mode is used to edit the User Drum Map. This mode is divided into the following 9 pages.

- 5-1. Voice 35
- 5-2. Volume, Pan 36
- 5-3. Tuning 36
- 5-4. Layer Balance 36
- 5-5. Decay, Cutoff Frequency 36
- 5-6. Reverb Send 36
- 5-7. Alternate Group, Key Assign Mode 37
- 5-8. Key Off Enable 37
- 5-9. Map Copy 37

* When a User Drum Kit (No. 49-80) is selected, the User Drum Map is the data that is used to set the note number's voice, etc., that is not assigned to the drum kit's pad input. Therefore, when a preset drum kit is selected the User Drum Map will not be used (the preset drum map will be used) so settings for functions [5-1] to [5-8] that appear in the display can not be carried out.

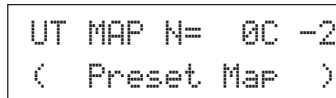

Also, settings cannot be carried out for the following functions [5-1] to [5-8] when the note numbers for the currently selected drum kit are already assigned/set.

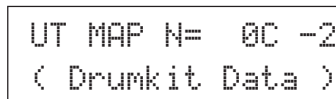

5-1. Voice

This creates a list that assigns a drum voice for each MIDI note number. Which MIDI note number ① will be received and which drum voice ② will be sounded.

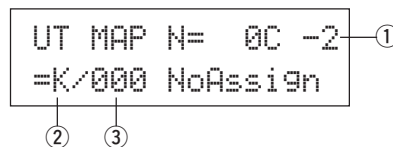

① N (MIDI Note Number)

[Range] 0-127 (C-2 to G8)

Sets the MIDI note number. Displays the note number and note name.

* According to the setting of the Utility mode's [1-1. Learn Mode] (P. 28) you can appoint the MIDI note number with key on input from the MIDI IN/TO HOST jacks.

② Voice Category

[Range] K, k, S, s, T, t, C, H, P, E, e, L, m

Selects the drum voice category.

Refer to Drum Kit Voice Edit Mode's [1-1. Voice] (P. 17).

Utility Mode

③ Voice Number Voice Name

[Range] 0, 1-127

Selects the assigned voice. Displays the voice number (1-127) and voice name.

If this parameter is set to "0", "NoAssign" will appear in the display and sound will not be produced.

* Refer to the [Drum Voice List] (P. 38).

5-2. Volume, Pan

This function sets the volume ② and pan ③ (the position in the stereo field) for each drum voice assigned to each MIDI note number ①.

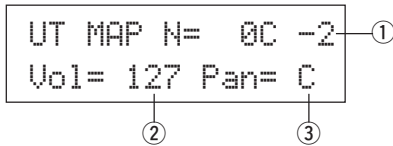

① N (MIDI Note Number)

Selects the MIDI note number (The same procedure as in [5-1. Voice]).

② Vol (Volume)

[Range] 0-127

③ Pan

[Range] L64 to C to R64.

5-3. Tuning

This function sets the pitch for each drum voice assigned to each MIDI note number ①.

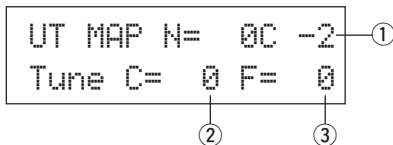

① N (MIDI Note Number)

Selects the MIDI note number (The same procedure as in [5-1. Voice]).

② TuneC (Tune Coarse)

[Range] -24 to 0 to +24

Tuning can be set in increments of a half step.

③ TuneF (Tune Fine)

[Range] -64 to 0 to +63

Tuning can be set in increments of 1.17 cents.

5-4. Layer Balance

When a drum voice assigned to a MIDI note number ① is made up of 2 layers (a single voice consisting of 2 voice waves), this function sets the volume balance between those 2 layers.

* When the selected voice only has a 1 layer, this setting will have no affect.

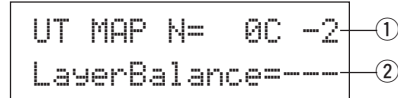

① N (MIDI Note Number)

Selects the MIDI note number (The same procedure as in [5-1. Voice]).

② LayerBalance (Layer Balance)

[Range] -64 to 0 to +63, ---

Sets the volume balance between the 2 layers.

* When the selected drum voice only has 1 layer, "----" will appear in the display and settings can not be carried out.

5-5. Decay, Cutoff Frequency

This function sets the drum voice decay, the filter's cutoff frequency and adjusts the tone of each voice assigned to each MIDI note number ①.

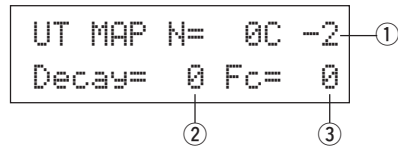

① N (MIDI Note Number)

Selects the MIDI note number (The same procedure as in [5-1. Voice]).

② Decay

[Range] -64 to 0 to +63.

Negative values will produce a clearer sound.

③ Fc (Cutoff Frequency)

[Range] -64 to 0 to +63

A positive value will produce a brighter sound, negative values will produce a rounder sound.

5-6. Reverb Send

This sets the Reverb Send Level ② for each drum voice assigned to each MIDI note number ①.

* The actual reverb send level will be determined by multiplying the Reverb Send Level set in [5-2. Drum Reverb Send] (P. 23) in the Drum Kit Voice Edit Mode.

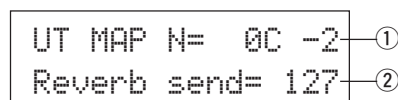

① N (MIDI Note Number)

Sets the MIDI note number (The same procedure as in [5-1. Voice]).

② Reverb send (Reverb Send Level)

[Range] 0-127

5-7. Alternate Group, Key Assign Mode

This sets the Alternate Group and Key Assign Mode for each drum voice ② assigned to each MIDI note number ①.

The function and setting of the Alternate Group, Key Assign Mode are the same functions and settings found in [2-3. Alternate Group, Key Assign Mode] (P. 19) in the Drum Kit Voice Edit Mode.

```
UT MAP N= 0C -2 ①
AltG= 0 Key=semi ② ③
```

① N (MIDI Note Number)

Selects the MIDI note number (The same procedure as in [5-1. Voice]).

② AltG (Alternate Group)

[Range] 0-15

③ Key (Key Assign Mode)

[Range] poly, semi, mono, high

5-8. Key Off Enable

This function decides whether or not to recognize key off messages for each drum voice ② assigned to each MIDI note number ①.

```
UT MAP N= 0C -2 ①
Key Off= disable ②
```

① N (MIDI Note Number)

Selects the MIDI note number (The same procedure as in [5-1. Voice]).

② Key Off

enable: Recognizes key off.

disable: Does not recognize key off.

* When this is set to "disable", some voices may sound continuously. Press the [SHIFT] and [VOICE] buttons to stop voices sounding.

5-9. Map Copy

This function copies the preset drum map's entire internal settings to a user drum map.

```
UT MAP Copy
from= 1Acoustic ①
```



When the Map Copy function is used, the user drum map's internal settings will be erased and replaced with the settings of the copy source. If you want to keep important user drum map settings, use the bulk dump operation and save the settings to an external device before executing the map copy.

① from (Preset Drum Map)

Selects the preset drum kit number (1-48) that will be the copy source. The drum kit number and drum kit name will be displayed.

Procedure

- In the display shown above, assign the copy source drum kit (drum map), press the [SAVE/ENT] button. The following display will appear asking for confirmation before the copy operation is carried out.

```
Copy Map From 1
Are you sure ?
```

- Press the [SAVE/ENT] or [VALUE+] button, the copy operation will be carried out.

* Press the [VALUE-] button to cancel the copy operation.

When the copy operation is complete, "Complete!" will appear.

Drum Voice List

● Voice Category

K : Acoustic Kick
 k : Electric Kick
 S : Acoustic Snare
 s : Electric Snare
 T : Acoustic Tom
 t : Electric Tom
 C : Cymbal
 H : Hi-Hat
 P : Percussion
 E : Effect 1
 e : Effect 2
 L : Drum Loop
 m : misc. voices

● : 2-layer voice

K : Acoustic Kick

- 1 2HedMed1 ●
- 2 2HedMed2 ●
- 3 Basic ●
- 4 BD DRY 1
- 5 BD DRY 2
- 6 BD DRY 3
- 7 BD DRY 4
- 8 BD GMH
- 9 BD GMM
- 10 BD GMM2
- 11 BD NN04C
- 12 Bottom ●
- 13 Pointy ●
- 14 SoTight ●
- 15 BDbasc1
- 16 BD 24Dry
- 17 BDafty1 ●
- 18 BDafty2 ●
- 19 MapleA20
- 20 MapleV20
- 21 BDstomp1 ●
- 22 Bdvman ●
- 23 BigSofty ●
- 24 2HeadHi ●
- 25 BD DRYB1
- 26 BD GMJ
- 27 BD GML
- 28 BD ROOM2
- 29 BD ROOM5
- 30 MapleAmb
- 31 BD Soft
- 32 2HeadLo ●
- 33 BD MONDO
- 34 BDbasc2
- 35 BD KONG1
- 36 BDersko1 ●
- 37 Bushy ●
- 38 BD ROOM3
- 39 BDbonzo2 ●
- 40 BD GATE1
- 41 BD GATE2
- 42 BD GateM

- 43 BD Metal ●
- 44 BD Rock1
- 45 BD Rock2
- 46 BD ROOM4
- 47 VeloRoom ●
- 48 WudPoint ●
- 49 BDevolvr ●
- 50 BDpalmer ●
- 51 Roomy ●
- 52 GrCMute
- 53 GrnCassa

k : Electric Kick

- 1 AnaQuick
- 2 BD ELEC2
- 3 BD Rave6 ●
- 4 BD Rave7 ●
- 5 BD Rave8 ●
- 6 BDDance1
- 7 BDDance2
- 8 BDDance3
- 9 BDDance4
- 10 BDdance5 ●
- 11 BDDance6
- 12 BDDance9
- 13 BDlong1 ●
- 14 BDRave10
- 15 BDRave11 ●
- 16 Sub1
- 17 Sub2 ●
- 18 Sub3 ●
- 19 QuikBuzz
- 20 BD ELEC1
- 21 BDdigiro ●
- 22 Bdfunky1 ●
- 23 BDindst1 ●
- 24 BDNIN1 ●
- 25 BDRevers
- 26 BDudu1 ●
- 27 BDurban1 ●
- 28 BDurban2 ●
- 29 BigBoy ●
- 30 MtlPoint ●
- 31 BDbass1 ●
- 32 Walkik ●
- 33 feffofm ●

S : Acoustic Snare

- 1 Loosy ●
- 2 LoosyRim ●
- 3 Barypic ●
- 4 Baryrim ●
- 5 Binky ●
- 6 MapleA50 ●
- 7 MickMHS ●
- 8 MapleV65 ●
- 9 Blu90Rim ●
- 10 Blue90
- 11 BrysnH
- 12 BrysnR
- 13 Drygyrim ●

- 14 Hip Hop
- 15 OldCan ●
- 16 SnareH
- 17 LiteSnr1 ●
- 18 Tosh Sn ●
- 19 MapleRim ●
- 20 BigWdRim ●
- 21 BigWood
- 22 Dry
- 23 Wood Sn
- 24 Wood65
- 25 ToshL fi ●
- 26 Looz Pic
- 27 PhlyRim ●
- 28 RIMhipop ●
- 29 LoosyP ●
- 30 SnareH2 ●
- 31 MickCJ8S ●
- 32 Maple12 ●
- 33 12Soprno
- 34 Picket ●
- 35 Slappy ●
- 36 BeatyRim
- 37 Beauty ●
- 38 BlastX ●
- 39 BrassRim
- 40 BuzRgRim ●
- 41 Buzzring ●
- 42 Jelyrim ●
- 43 MrcSnrH
- 44 MrcSnrM
- 45 RIMBrass ●
- 46 RIMetal ●
- 47 RIMnatrl ●
- 48 RIMouch! ●
- 49 RoldGold
- 50 SnareL2 ●
- 51 Steel ●
- 52 Sticky ●
- 53 VtgBras1
- 54 VtgBras2
- 55 MickDarS
- 56 BETA Sn ●
- 57 Brassy ●
- 58 Deep&Dry ●
- 59 MickOLD ●
- 60 Fat looz
- 61 RIMdry1 ●
- 62 Rock ●
- 63 SnareM
- 64 SnarDeep ●
- 65 BrassPic
- 66 DryMetal ●
- 67 PicloRim ●
- 68 BluePIC ●
- 69 Metalpic ●
- 70 ClubOK ●
- 71 ClubORrim
- 72 Piclodry ●
- 73 Fusion ●
- 74 TrashRIM ●
- 75 Amb 02

- 76 Ambient1 ●
- 77 Ambt1rim ●
- 78 Cool Dry ●
- 79 OpnRim ●
- 80 Powerpic ●
- 81 Pwrprcrim ●
- 82 Room ●
- 83 Amb 01
- 84 Ambient ●
- 85 ParadeS ●
- 86 Amb 03
- 87 AmbiRim ●
- 88 Nashville ●
- 89 OpnRimA ●
- 90 OpnRimB ●
- 91 OpnRimC ●
- 92 OpnRimD ●
- 93 RIMrock ●
- 94 RIMwatts ●
- 95 Fatbrass
- 96 Fatbrim ●
- 97 Brass55 ●
- 98 Steel65 ●
- 99 Alumi55 ●
- 100 RoldRim ●
- 101 SAmbie1 ●
- 102 SAmbie2 ●
- 103 SAmbie3 ●
- 104 Gate
- 105 GhiGateSn ●
- 106 RockH
- 107 RockL
- 108 RockM
- 109 S SStck1
- 110 S SStck2
- 111 S SStck3
- 112 S STK_HT
- 113 SidRim ●
- 114 SidStick ●
- 115 Timbrim ●
- 116 SnrGhst ●
- 117 TambSnre ●
- 118 SnareLes ●
- 119 LesRim ●
- 120 Latinrim ●
- 121 SnRoll1*
- 122 SnRoll2*

s : Electric Snare

- 1 AnaDaRim ●
- 2 AnaDark
- 3 AnaHit ●
- 4 Analog H ●
- 5 Analog L ●
- 6 AnalogH1 ●
- 7 AnalogL1 ●
- 8 AnaTite
- 9 AnaWide
- 10 AnaWiRim ●
- 11 AnHitRim ●
- 12 AnSStick
- 13 Dance

- 14 Dance01
- 15 Dance02
- 16 Dance03
- 17 Dance05
- 18 Dance06
- 19 Elektrik
- 20 SAmbie4 ●
- 21 SAAna1 ●
- 22 SAAna2 ●
- 23 SAAna3 ●
- 24 Brsh H
- 25 AnAirRim ●
- 26 CapGun ●
- 27 CapRim ●
- 28 Dryroom ●
- 29 Electric
- 30 HiFive
- 31 RIMpopr ●
- 32 Sambie6 ●
- 33 AnaAir ●
- 34 AnaBuzz ●
- 35 AnaBzRim ●
- 36 AnaMeRim ●
- 37 AnaMetal ●
- 38 AnaShh ●
- 39 AnaShRim ●
- 40 AnaSlegh ●
- 41 AnaSIRim ●
- 42 AnaVel ●
- 43 AnaWee ●
- 44 AnaWeRim ●
- 45 AnVelRim ●
- 46 ASOBI ●
- 47 Blaaaghf ●
- 48 Brsh2Rim ●
- 49 BrsUpRim ●
- 50 DanceP
- 51 Distort ●
- 52 Dry Guy ●
- 53 Elem1
- 54 Elem2
- 55 Elem3 ●
- 56 EltrcRIM ●
- 57 Eno rim ●
- 58 Enotype ●
- 59 Fact rim ●
- 60 Factory ●
- 61 Fantam ●
- 62 FantaRim ●
- 63 Filtrroll ●
- 64 Filtrim ●
- 65 FX ●
- 66 FX rim ●
- 67 Hi5Rim ●
- 68 JelyRoll
- 69 Philydry ●
- 70 RIMshort ●
- 71 RO_S
- 72 RockRim ●
- 73 RollEm1 ●
- 74 RollEm2 ●
- 75 RollEm3

- 76 RollRim1 ●
- 77 RollRim2
- 78 RollRim3
- 79 Ruberbnd ●
- 80 S Gate1
- 81 S Gate2
- 82 S Gate3
- 83 S RuberS
- 84 Sddark! ●
- 85 SDdkrim ●
- 86 SDind58 ●
- 87 Sheetmtl
- 88 ShmtlrIm ●
- 89 Smacker ●
- 90 Snarf ●
- 91 SnarfRim ●
- 92 SteelRim ●
- 93 Tekk1
- 94 Tekk2
- 95 Tekk3
- 96 UnclAB ●
- 97 UnclARim ●
- 98 WackyEFX ●
- 99 Brsh1Rim ●
- 100 BrshAtak
- 101 BrshHit1
- 102 BrshHit2
- 103 BrshOp
- 104 BrshSc
- 105 BrshSlp
- 106 BrshSlpL
- 107 BrshSw
- 108 BrshSwep
- 109 BrshTap1
- 110 BrshTap2
- 111 BrshTap3
- 112 BrshTp
- 113 BrSwH*
- 114 BrSwL*
- 115 BrSwTime
- 116 BrSwTRim ●
- 117 S Brsh
- 118 Shotgun ●
- 119 tkattak! ●
- 120 Manycure ●

T : Acoustic Tom

- 1 Dry1 Hi
- 2 Dry1 Mid
- 3 Dry1 Lo
- 4 Dry1 Flr
- 5 DRY GM6
- 6 DRY GM5
- 7 DRY GM4
- 8 DRY GM3
- 9 DRY GM2
- 10 DRY GM1
- 11 Maple10
- 12 Maple12
- 13 Maple14
- 14 Maple16
- 15 Lite Hi ●

- 16 Lite Mid ●
- 17 Lite Lo ●
- 18 Lite Flr ●
- 19 Jazz Hi
- 20 Jazz Mid
- 21 Jazz Lo
- 22 Jazz Flr
- 23 BrshJzHi
- 24 BrshJzMd
- 25 BrshJzLo
- 26 BrshJzFl
- 27 BrshRkHi
- 28 BrshRkMd
- 29 BrshRkLo
- 30 BrshRkFl
- 31 TOMntrlH
- 32 TOMntrlM
- 33 TOMntrlL
- 34 TOMntrlF
- 35 Dry2 Hi
- 36 Dry2 Mid
- 37 Dry2 Lo
- 38 Dry2 Flr
- 39 Room3 Hi
- 40 Room3Mid ●
- 41 Room3 Lo ●
- 42 Room3Flr ●
- 43 RoomP H
- 44 RoomP M
- 45 RoomP L ●
- 46 RoomP F
- 47 RoomQH ●
- 48 RoomQM ●
- 49 RoomQL ●
- 50 RoomQF ●
- 51 Room 6 ●
- 52 Room 5 ●
- 53 Room 4 ●
- 54 Room 3 ●
- 55 Room 2 ●
- 56 Room 1 ●
- 57 Rock 6
- 58 Rock 5
- 59 Rock 4
- 60 Rock 3
- 61 Rock 2
- 62 Rock 1
- 63 SAmbTmH ●
- 64 SAmbTmM ●
- 65 SAmbTmL ●
- 66 SAmbTmF ●
- 67 AmbTomH
- 68 AmbTomM
- 69 AmbTomL
- 70 AmbTomF
- 71 ACTomH
- 72 ACTomM
- 73 ACTomL
- 74 ACTomF
- 75 Room1 Hi ●
- 76 Room1Mid ●
- 77 Room1 Lo ●

- 78 Room1Flr ●
- 79 Room2 Hi ●
- 80 Room2Mid ●
- 81 Room2 Lo ●
- 82 Room2Flr ●
- 83 Night H
- 84 Night M
- 85 Night L
- 86 Night F
- 87 TOMXfadH ●
- 88 TOMXfadM ●
- 89 TOMXfadL ●
- 90 TOMXfadF ●

t : Electric Tom

- 1 Ana 1Hi
- 2 Ana 1Mid
- 3 Ana 1Lo
- 4 Ana 1Flr
- 5 Ana 2Hi ●
- 6 Ana 2Mid ●
- 7 Ana 2Lo ●
- 8 Ana 2flr
- 9 AnlgTom6
- 10 AnlgTom5
- 11 AnlgTom4
- 12 AnlgTom3
- 13 AnlgTom2
- 14 AnlgTom1
- 15 TEKK 1H
- 16 TEKK 1M
- 17 TEKK 1L
- 18 TEKK 1F
- 19 TEKK 2H
- 20 TEKK 2M
- 21 TEKK 2L
- 22 TEKK 2F
- 23 TEKK 3H
- 24 TEKK 3M
- 25 TEKK 3L
- 26 TEKK 3F
- 27 AnalndsH ●
- 28 AnalndsM ●
- 29 AnalndsL ●
- 30 AnalndsF ●
- 31 E Tom6
- 32 E Tom5
- 33 E Tom4
- 34 E Tom3
- 35 E Tom2
- 36 E Tom1
- 37 HybridH ●
- 38 HybridM ●
- 39 HybridL ●
- 40 HybridF ●
- 41 ElectrcH
- 42 ElectrcM
- 43 ElectrcL
- 44 ElectrcF
- 45 Distrt H
- 46 Distrt M
- 47 Distrt L

Drum Voice List

- 48 Distrt F
- 49 ETMooRH
- 50 ETMooRM
- 51 ETMooRL
- 52 ETMooRXL
- 53 IndTmH ●
- 54 IndTmM ●
- 55 IndTmL ●
- 56 IndTmF ●
- 57 TM Revrs
- 58 Analog
- 59 T GongE

C : Cymbal

- 1 CrashB
- 2 BriteCrs
- 3 C Crash
- 4 C CrshAC
- 5 CrshDRK
- 6 DeepDRK
- 7 FasCrash ●
- 8 FastCras
- 9 PaperThn
- 10 ReverseC
- 11 SoftRoll
- 12 C CrshSi ●
- 13 C FX02
- 14 DeepCym ●
- 15 FlatTop ●
- 16 RideDark
- 17 Ridedrk ●
- 18 Ride'EM ●
- 19 RideLite
- 20 Rider3 ●
- 21 RideRock
- 22 RideRock
- 23 RidesizA ●
- 24 RidesizB ●
- 25 RidesizC ●
- 26 RideXfd ●
- 27 RocksizL ●
- 28 SizzlDrk ●
- 29 Sizzler ●
- 30 SizzlLit ●
- 31 SizzlRck ●
- 32 RidB Lit
- 33 Bell A
- 34 BellTip
- 35 RidB Drk
- 36 RidB Rc
- 37 China
- 38 ChinaHi
- 39 MinChina
- 40 Clusher ●
- 41 C Splsh1
- 42 C Splsh2
- 43 C FX01
- 44 AngCym
- 45 Ride Anl
- 46 HCym1
- 47 HCym2 ●
- 48 HCymClsL

- 49 HCymClsM
- 50 HCymOpnL
- 51 HCymOpnM

H : Hi-Hat

- 1 H Cls01
- 2 H Cls13
- 3 H ClsA1
- 4 H ClsA2
- 5 H ClsMu
- 6 H ClsNB1
- 7 H ClsTc1
- 8 H ClsTc3
- 9 H QOPMu
- 10 H QOPn13
- 11 H TiCls1
- 12 H TiCls2
- 13 HHcl2Xfd ●
- 14 HHclsXfd ●
- 15 HHRoKcls
- 16 HH32cls ●
- 17 HHbrtcls ●
- 18 H OPMu
- 19 H Opn13
- 20 H OpnDW ●
- 21 H OpnDWX ●
- 22 H OpnL1 ●
- 23 H OpnL2 ●
- 24 H OpnL3 ●
- 25 H OpnLK ●
- 26 H OpnLX1 ●
- 27 H OpnMU ●
- 28 H OpnNB
- 29 HHRoKopn
- 30 HHopen#1 ●
- 31 H PdI13
- 32 H PdIDW
- 33 H PdLit ●
- 34 H PdIMu
- 35 H PdINB
- 36 H PdTit
- 37 HHFTpd1
- 38 Hpdcls1 ●
- 39 Hpdcls2 ●
- 40 Hpdcls3 ●
- 41 Hpdcls4 ●
- 42 FTsplRK
- 43 FTsplRK2 ●
- 44 FTsplsh1
- 45 FTsplsh2 ●
- 46 H SplNB
- 47 H Splsh
- 48 Hpsplsh1 ●
- 49 H OpnAMu
- 50 H OpnAn
- 51 H OpnLA1 ●
- 52 H OpnLA2 ●

P : Percussion

- 1 AgogoCh
- 2 AgogoH1

- 3 AgogoH2
- 4 AnCongaM
- 5 AnCowbll
- 6 AnMaracs ●
- 7 ATR
- 8 BassDr
- 9 Bell
- 10 Bell Tree
- 11 Bongo Hi
- 12 Bongo Lo
- 13 Bongo Mu
- 14 Cabasa1
- 15 Cabasa2 ●
- 16 Castanet
- 17 Clap8
- 18 ClapA
- 19 Clvs
- 20 ClvsA
- 21 Conga
- 22 Conga8H
- 23 CongaC
- 24 CongaG
- 25 CongaH
- 26 CongaM
- 27 CongaMV
- 28 CongAn
- 29 CongaO
- 30 CongaS
- 31 CongBe
- 32 CongC7
- 33 CowB1
- 34 CowB2
- 35 CowBAn
- 36 CowBM
- 37 CuicaH
- 38 CuicaL
- 39 EthWB
- 40 FSnap2
- 41 GONG
- 42 GranC
- 43 Guiro
- 44 GuiSht
- 45 HiQ
- 46 JingBell
- 47 Kalmb
- 48 Log H
- 49 Log L
- 50 Maracas1 ●
- 51 Maracas2
- 52 Maracas3
- 53 MtBel
- 54 Mtron
- 55 Scrach
- 56 Shake1
- 57 Shake2
- 58 ShakeA
- 59 SlBell
- 60 Surdo
- 61 SurdoM
- 62 Tabla B
- 63 Tabla BL
- 64 Tabla BM

- 65 Tabla BV
- 66 Tabla OV
- 67 TablaH
- 68 TablaM
- 69 TablaN
- 70 TablaO
- 71 Taiko
- 72 TalkD
- 73 TalknDrD
- 74 TalknDrU
- 75 TalknDrV
- 76 Tamba
- 77 TambHH ●
- 78 Tambourn
- 79 Tambrn
- 80 Timb
- 81 TimbH
- 82 TimbL
- 83 TimCas
- 84 TimpH
- 85 TimpL
- 86 Triang
- 87 TriMut
- 88 Udo F
- 89 Udo H
- 90 Udo L
- 91 Udu808H ●
- 92 Udu808L ●
- 93 VibrSlap
- 94 WCHim
- 95 Whist
- 96 WHP
- 97 WoodBloc
- 98 XfadeTri ●
- 99 SWhistH*
- 100 SWhistL*

E : Effect 1

- 1 6AMBreth ●
- 2 Ambush ●
- 3 AMRhythm ●
- 4 Applau ●
- 5 Bird
- 6 Bird-P
- 7 Bottle
- 8 BreakOut
- 9 BrsHit
- 10 BuzzyWak ●
- 11 C Crash
- 12 CarPss
- 13 CBRadi
- 14 ComVc
- 15 CoolSA
- 16 Creature ●
- 17 Crush
- 18 CStart
- 19 Didger
- 20 Dog
- 21 DogHats
- 22 Door
- 23 DSqrm
- 24 FM Met

- 25 FStep
- 26 Funky
- 27 Gargoyle ●
- 28 Glass1
- 29 Gun 1
- 30 Gun 2
- 31 Gun 3
- 32 HaHoHee ●
- 33 HandyDad ●
- 34 HandySon ●
- 35 Heli
- 36 HipNs
- 37 INDbells ●
- 38 INDchina
- 39 INDconga ●
- 40 INDcrash
- 41 InddogCR ●
- 42 INDhihat ●
- 43 INDrave ●
- 44 INDride ●
- 45 INDride2 ●
- 46 INDride3
- 47 INDshakr ●
- 48 Indust
- 49 InsAmb
- 50 Laugh
- 51 LoMo
- 52 MetalDip ●
- 53 MotoM
- 54 Motor
- 55 NoyzEB ●
- 56 OOOWWW
- 57 OrchSmsh ●
- 58 OrcHt1
- 59 OrcHt2
- 60 PAD
- 61 RatlBoom ●
- 62 RaveRide ●
- 63 RaveWave ●
- 64 Reverse ●
- 65 Ring
- 66 RubbrOil
- 67 Scream
- 68 Seasho
- 69 Shazam! ●
- 70 SlikRoad ●
- 71 SloSprkl ●
- 72 Stream
- 73 TablaX ●
- 74 TakeOff ●
- 75 TekGt
- 76 Thundr
- 77 TimbTimp ●
- 78 TineDrum ●
- 79 Tire
- 80 TungDrum ●
- 81 TV vo
- 82 TymKeepr ●
- 83 USS
- 84 VocIshKR ●
- 85 WetMetal ●
- 86 Yadee

e : Effect 2

- 1 JNGLSN1 ●
- 2 JNGLSN2 ●
- 3 JNGLSN3 ●
- 4 JNGLSN4 ●
- 5 JNGLSN5 ●
- 6 JNGLSN6 ●
- 7 JNGLSN7 ●
- 8 JNGLSN8
- 9 JNGLSN9 ●
- 10 JNGLSN10
- 11 JNGBASS! ●
- 12 JNGBASS2 ●
- 13 JNGBASS3 ●
- 14 JNGBASS4 ●
- 15 JNGBASS5 ●
- 16 JNGBASS6 ●
- 17 JNGBASS7 ●
- 18 JNGBASS8 ●
- 19 GUMYBASS ●
- 20 BDSUBSNK ●
- 21 TENDO ●
- 22 SPIKER ●
- 23 PULSAR
- 24 PULSAR2 ●
- 25 PULSAR3 ●
- 26 DALIBAS1 ●
- 27 DALIBAS2 ●
- 28 DALIBAS3
- 29 IRONBASS ●
- 30 SEAMNSTR ●
- 31 D&BFRAG1
- 32 POPPX
- 33 WINER ●
- 34 DOOMED ●
- 35 ANVILISH
- 36 TRANQUL ●
- 37 MOSHER ●
- 38 D&BFRAG8
- 39 PEEPER
- 40 WYZOG
- 41 D&FRAG11
- 42 SCRUNCH
- 43 VOLTAGE ●
- 44 D&FRAG14
- 45 GRONKER
- 46 SEMILOOP
- 47 POINGER
- 48 JNGSN11 ●
- 49 SUKRPNCH
- 50 D&FRAG20
- 51 BOUNCER ●
- 52 SHUTDOWN ●
- 53 DOPPLER ●
- 54 DUCKSTER ●
- 55 TAMTAMY ●
- 56 PANKY ●
- 57 ANAFROGR ●
- 58 GOWAH ●
- 59 DEEPDIVE ●
- 60 ASCENDER

- 61 JURASSIC ●
- 62 CLOUDS ●
- 63 TRAINBRK ●
- 64 RUNNER ●
- 65 RADAMACU ●
- 66 UMK 47
- 67 FRAG23
- 68 AmbHit10
- 69 WAKX PAD
- 70 AmbHit01
- 71 QueSPACE
- 72 AmbHit02
- 73 FRAG13
- 74 Vocal04 ●
- 75 FRAG03
- 76 FRAG14
- 77 FRAG12
- 78 FRAG08
- 79 FRAG01
- 80 FRAG18
- 81 FRAG11
- 82 FRAG05
- 83 FRAG21
- 84 FRAG20

L : Drum Loop

- 1 DigiTime ●
- 2 Hollis L
- 3 KillnL
- 4 LITELoop
- 5 LoMLoop ●
- 6 MachineL ●
- 7 NYCLoop ●
- 8 PsychoLP ●
- 9 SNAPLOOP
- 10 AlienSp ●
- 11 Cymbloop ●
- 12 DIGERDO
- 13 Spirals
- 14 SwingnL
- 15 UptownL
- 16 WE LOOP
- 17 E NZE
- 18 ET Loop ●
- 19 EvlLoop
- 20 FactryLP
- 21 HellsBel
- 22 LoMO LP
- 23 LoMsolo
- 24 LPscNoiz
- 25 HeliLoop
- 26 StreamLP

m : misc. voices

- 1 Brass 4
- 2 Brass 5
- 3 Celesta
- 4 Chor 516
- 5 Chor 539
- 6 Chorus 4
- 7 GlockenH

- 8 GlockenL
- 9 GlockenM
- 10 Marimba
- 11 MTrp 4
- 12 ORGAN 3
- 13 SBBrass 4
- 14 SBBrass 5
- 15 sitar599
- 16 SteelDr3
- 17 SynPf 3
- 18 Trb 3
- 19 Trp 4
- 20 vibe 541
- 21 Xylophon
- 22 SStrngA4
- 23 SStrngB4
- 24 STRNG 3
- 25 STRNG 4
- 26 Syn 3
- 27 SynSt 3
- 28 AcBass
- 29 BassSAWH
- 30 BassSAWL
- 31 BassSINH
- 32 BassSINL
- 33 SyBass2H
- 34 SyBass2L

GM Keyboard Voice List

● : 2-layer voice

No.	Category	Name	No.	Category	Name	No.	Category	Name	No.	Category	Name
1	Piano	GrandPno	33	Bass	Aco.Bass	65	Reed	SprnoSax	97	Synth	Rain ●
2		BritePno	34		FngrBass	66		Alto Sax	98	Effects	SoundTrk ●
3		E.Grand ●	35		PickBass	67		TenorSax	99		Crystal ●
4		HnkyTonk ●	36		Fretless	68		Bari.Sax	100		Atmosphr ●
5		E.Piano1 ●	37		SlapBas1	69		Oboe	101		Bright ●
6		E.Piano2 ●	38		SlapBas2	70		Eng.Horn	102		Goblins ●
7		Harpsi.	39		SynBass1	71		Bassoon	103		Echoes ●
8		Clavi.	40		SynBass2	72		Clarinet	104		SF ●
9	Chromatic	Celesta	41	Strings	Violin	73	Pipe	Piccolo	105	Ethnic	Sitar
10	Percussion	Glocken	42		Viola	74		Flute	106		Banjo
11		MusicBox ●	43		Cello	75		Recorder	107		Shamisen
12		Vibes	44		ContraBs	76		PanFlute	108		Koto
13		Marimba	45		Trem.Str ●	77		Bottle ●	109		Kalimba
14		Xylophon	46		Pizz.Str ●	78		Shakhchi	110		Bagpipe ●
15		TubulBel	47		Harp	79		Whistle	111		Fiddle
16		Dulcimer ●	48		Timpani	80		Ocalina	112		Shanai
17	Organ	DrawOrgn	49	Ensemble	Strings1	81	Synth Lead	SquareLd ●	113	Percussive	TnklBell ●
18		PercOrgn	50		Strings2	82		Saw.Lead ●	114		Agogo
19		RockOrgn ●	51		Syn.Str1 ●	83		CaliopLd ●	115		SteelDrum ●
20		ChrChOrg ●	52		Syn.Str2 ●	84		Chiff Ld ●	116		WoodBlok
21		ReedOrgn	53		ChoirAah ●	85		CharanLd ●	117		TaikoDrum
22		Acordion ●	54		VoiceOoh	86		Voice Ld ●	118		MelodTom
23		Harmnica	55		SynVoice	87		Fifth Ld ●	119		Syn.Drum
24		TangoAcd ●	56		Orch.Hit	88		Bass &Ld ●	120		RevCymbal
25	Guitar	NylonGtr	57	Brass	Trumpet	89	Synth Pad	NewAgePd ●	121	Sound	FretNoiz
26		SteelGtr	58		Trombone	90		Warm Pad ●	122	Effect	BrthNoiz
27		Jazz Gtr	59		Tuba	91		PolySyPd ●	123		Seashore ●
28		CleanGtr ●	60		Mute.Trp	92		ChoirPad ●	124		Tweet ●
29		Mute.Gtr	61		Fr.Horn	93		BowedPad ●	125		Telephone
30		Ovrdrive	62		BrasSect	94		MetalPad ●	126		Helicptr ●
31		Dist.Gtr	63		SynBras1 ●	95		Halo Pad ●	127		Applause ●
32		GtrHarmo	64		SynBras2 ●	96		SweepPad ●	128		Gunshot

Preset Drum Kit List

● : Kits used with the pad songs

No.	Name	No.	Name	No.	Name	No.	Name
1	Acoustic	13	(In)	25	World	37	MondoKit ●
2	NewBeat	14	In&Out	26	Reggae	38	Torqkit ●
3	Rock kit	15	HipFunky	27	Tabla	39	Mystery ●
4	RockDry1	16	Dance 1	28	Cocktail	40	GM std 1
5	RockDry2	17	Dance 2	29	JamKit99	41	GM std 2
6	RockDry3	18	SoDance	30	GoezOn!?	42	GM room
7	RockDry4	19	Manh	31	InDaHood	43	GM rock
8	BigRevrbr	20	D@RK	32	GroovKit ●	44	GM elec.
9	Ballade	21	Oh!No!	33	Bs.@Base ●	45	GM anal.
10	BeBop	22	Latin/Tm	34	JungleNY	46	GM jazz
11	Andora	23	LatinPer	35	Snapkit	47	GM brush
12	Room Kit	24	Zebulon	36	JumpBack ●	48	GM class

No. 1 Acoustic

Input Source	Voice-1 Cat./No./Name	Voice-2 Cat./No./Name
pad1	K 17 BDaftty1	K 0 NoAssign
rim1	K 0 NoAssign	K 0 NoAssign
pad2	S 1 Loosy	K 0 NoAssign
rim2	S 79 OpnRim	K 0 NoAssign
pad3	T 1 Dry1 Hi	K 0 NoAssign
rim3	T 71 ACTomH	K 0 NoAssign
pad4	T 2 Dry1 Mid	K 0 NoAssign
rim4	T 72 ACTomM	K 0 NoAssign
pad5	T 3 Dry1 Lo	K 0 NoAssign
rim5	T 73 ACTomL	K 0 NoAssign
pad6	C 28 SizzlDrk	K 0 NoAssign
rim6	C 24 RidesizB	K 0 NoAssign
pad7	C 1 CrashB	K 0 NoAssign
rim7	C 37 China	K 0 NoAssign
open	H 23 H OpnL2	K 0 NoAssign
rimOpen	H 25 H OpnLK	K 0 NoAssign
close	H 23 H OpnL2	K 0 NoAssign
rimClose	H 23 H OpnL2	K 0 NoAssign
footClose	H 32 H PdlDW	K 0 NoAssign
splash	H 48 Hpsplsh1	K 0 NoAssign
pad9	C 33 Bell A	K 0 NoAssign
pad10	P 33 CowB1	K 0 NoAssign

No. 2 NewBeat

Input Source	Voice-1 Cat./No./Name	Voice-2 Cat./No./Name
pad1	K 43 BD Metal	K 0 NoAssign
rim1	K 0 NoAssign	K 0 NoAssign
pad2	S 46 RIMetal	K 0 NoAssign
rim2	S 33 12Soprno	K 0 NoAssign
pad3	T 58 Rock 5	K 0 NoAssign
rim3	T 6 DRY GM5	K 0 NoAssign
pad4	T 60 Rock 3	K 0 NoAssign
rim4	T 8 DRY GM3	K 0 NoAssign
pad5	T 61 Rock 2	K 0 NoAssign
rim5	T 10 DRY GM1	K 0 NoAssign
pad6	C 16 RideDark	K 0 NoAssign
rim6	C 20 Rider3	K 0 NoAssign
pad7	C 1 CrashB	K 0 NoAssign
rim7	C 2 BriteCrs	K 0 NoAssign
open	H 26 H OpnLX1	K 0 NoAssign
rimOpen	H 26 H OpnLX1	K 0 NoAssign
close	H 1 H Cls01	K 0 NoAssign
rimClose	H 34 H PdlMu	K 0 NoAssign
footClose	H 38 Hpdclcs1	K 0 NoAssign
splash	H 48 Hpsplsh1	K 0 NoAssign
pad9	C 33 Bell A	K 0 NoAssign
pad10	P 33 CowB1	K 0 NoAssign

No. 3 Rock kit

Input Source	Voice-1 Cat./No./Name	Voice-2 Cat./No./Name
pad1	K 34 BDbasc2	K 32 2HeadLo
rim1	P 34 CowB2	K 0 NoAssign
pad2	s 87 Sheetmtl	S 1 Loosy
rim2	S 96 Fatbrim	K 0 NoAssign
pad3	T 75 Room1 Hi	K 0 NoAssign
rim3	T 83 Night H	K 0 NoAssign
pad4	T 76 Room1Mid	K 0 NoAssign
rim4	T 84 Night M	K 0 NoAssign
pad5	T 77 Room1 Lo	K 0 NoAssign
rim5	T 85 Night L	K 0 NoAssign
pad6	C 31 SizzlRck	K 0 NoAssign
rim6	C 36 RidB Rc	K 0 NoAssign
pad7	C 37 China	K 0 NoAssign
rim7	C 1 CrashB	K 0 NoAssign

open	H 29 HHRoKopn	K 0 NoAssign
rimOpen	H 29 HHRoKopn	K 0 NoAssign
close	H 6 H ClsNB1	K 0 NoAssign
rimClose	H 5 H ClsMu	K 0 NoAssign
footClose	H 37 HHFTpdl1	K 0 NoAssign
splash	H 44 FTsplsh1	K 0 NoAssign
pad9	C 32 RidB Lit	K 0 NoAssign
pad10	P 33 CowB1	K 0 NoAssign

No. 4 RockDry1

Input Source	Voice-1 Cat./No./Name	Voice-2 Cat./No./Name
pad1	K 41 BD GATE2	K 35 BD KONG1
rim1	K 0 NoAssign	K 0 NoAssign
pad2	S 97 Brass55	K 0 NoAssign
rim2	S 96 Fatbrim	K 0 NoAssign
pad3	T 58 Rock 5	K 0 NoAssign
rim3	T 83 Night H	K 0 NoAssign
pad4	T 59 Rock 4	K 0 NoAssign
rim4	T 84 Night M	K 0 NoAssign
pad5	T 60 Rock 3	K 0 NoAssign
rim5	T 85 Night L	K 0 NoAssign
pad6	C 22 RideRock	K 0 NoAssign
rim6	C 37 China	K 0 NoAssign
pad7	C 41 C Splsh1	K 0 NoAssign
rim7	C 3 C Crash	K 0 NoAssign
open	H 43 FTsplRK2	K 0 NoAssign
rimOpen	H 29 HHRoKopn	K 0 NoAssign
close	H 2 H Cls13	K 0 NoAssign
rimClose	H 29 HHRoKopn	K 0 NoAssign
footClose	H 37 HHFTpdl1	K 0 NoAssign
splash	H 48 Hpsplsh1	K 0 NoAssign
pad9	C 35 RidB Drk	K 0 NoAssign
pad10	P 33 CowB1	K 0 NoAssign

No. 5 RockDry2

Input Source	Voice-1 Cat./No./Name	Voice-2 Cat./No./Name
pad1	K 32 2HeadLo	K 11 BD NN04C
rim1	K 0 NoAssign	K 0 NoAssign
pad2	S 63 SnareM	K 0 NoAssign
rim2	S 47 RIMntrl	K 0 NoAssign
pad3	T 1 Dry1 Hi	K 0 NoAssign
rim3	T 83 Night H	K 0 NoAssign
pad4	T 2 Dry1 Mid	K 0 NoAssign
rim4	T 84 Night M	K 0 NoAssign
pad5	T 3 Dry1 Lo	K 0 NoAssign
rim5	T 85 Night L	K 0 NoAssign
pad6	C 16 RideDark	K 0 NoAssign
rim6	C 24 RidesizB	K 0 NoAssign
pad7	C 37 China	K 0 NoAssign
rim7	C 1 CrashB	K 0 NoAssign
open	H 26 H OpnLX1	K 0 NoAssign
rimOpen	H 23 H OpnL2	K 0 NoAssign
close	H 6 H ClsNB1	K 0 NoAssign
rimClose	H 23 H OpnL2	K 0 NoAssign
footClose	H 35 H PdlNB	K 0 NoAssign
splash	H 46 H SplNB	K 0 NoAssign
pad9	C 33 Bell A	K 0 NoAssign
pad10	P 33 CowB1	K 0 NoAssign

No. 6 RockDry3

Input Source	Voice-1 Cat./No./Name	Voice-2 Cat./No./Name
pad1	K 39 BDbonzo2	K 19 MapleA20
rim1	K 0 NoAssign	K 0 NoAssign
pad2	S 60 Fat looz	K 0 NoAssign
rim2	s 19 Electrik	K 0 NoAssign
pad3	T 75 Room1 Hi	K 0 NoAssign

rim3	T 71 ACTomH	K 0 NoAssign
pad4	T 76 Room1Mid	K 0 NoAssign
rim4	T 72 ACTomM	K 0 NoAssign
pad5	T 77 Room1 Lo	K 0 NoAssign
rim5	T 73 ACTomL	K 0 NoAssign
pad6	C 16 RideDark	K 0 NoAssign
rim6	C 24 RidesizB	K 0 NoAssign
pad7	C 39 MinChina	K 0 NoAssign
rim7	C 5 CrshDRK	K 0 NoAssign
open	H 26 H OpnLX1	K 0 NoAssign
rimOpen	H 23 H OpnL2	K 0 NoAssign
close	H 6 H ClsNB1	K 0 NoAssign
rimClose	H 23 H OpnL2	K 0 NoAssign
footClose	H 32 H PdlDW	K 0 NoAssign
splash	H 46 H SplNB	K 0 NoAssign
pad9	C 33 Bell A	K 0 NoAssign
pad10	P 33 CowB1	K 0 NoAssign

No. 7 RockDry4

Input Source	Voice-1 Cat./No./Name	Voice-2 Cat./No./Name
pad1	K 49 BDevolvr	K 3 Basic
rim1	K 0 NoAssign	K 0 NoAssign
pad2	S 91 OpnRimC	K 0 NoAssign
rim2	S 105 GhiGateSn	K 0 NoAssign
pad3	T 35 Dry2 Hi	K 0 NoAssign
rim3	T 71 ACTomH	K 0 NoAssign
pad4	T 36 Dry2 Mid	K 0 NoAssign
rim4	T 72 ACTomM	K 0 NoAssign
pad5	T 37 Dry2 Lo	K 0 NoAssign
rim5	T 73 ACTomL	K 0 NoAssign
pad6	C 16 RideDark	K 0 NoAssign
rim6	C 24 RidesizB	K 0 NoAssign
pad7	C 39 MinChina	K 0 NoAssign
rim7	C 5 CrshDRK	K 0 NoAssign
open	H 26 H OpnLX1	K 0 NoAssign
rimOpen	H 23 H OpnL2	K 0 NoAssign
close	H 6 H ClsNB1	K 0 NoAssign
rimClose	H 23 H OpnL2	K 0 NoAssign
footClose	H 32 H PdlDW	K 0 NoAssign
splash	H 46 H SplNB	K 0 NoAssign
pad9	C 33 Bell A	K 0 NoAssign
pad10	P 33 CowB1	K 0 NoAssign

No. 8 BigReverb

Input Source	Voice-1 Cat./No./Name	Voice-2 Cat./No./Name
pad1	K 2 2HedMed2	K 1 2HedMed1
rim1	K 0 NoAssign	K 0 NoAssign
pad2	S 23 Wood Sn	K 0 NoAssign
rim2	S 23 Wood Sn	K 0 NoAssign
pad3	T 6 DRY GM5	K 0 NoAssign
rim3	P 57 Shake2	K 0 NoAssign
pad4	T 7 DRY GM4	K 0 NoAssign
rim4	P 76 TambA	K 0 NoAssign
pad5	T 9 DRY GM2	K 0 NoAssign
rim5	P 97 WoodBloc	K 0 NoAssign
pad6	C 23 RidesizA	K 0 NoAssign
rim6	C 19 RideLite	K 0 NoAssign
pad7	C 3 C Crash	K 0 NoAssign
rim7	C 6 DeepDRK	K 0 NoAssign
open	H 26 H OpnLX1	K 0 NoAssign
rimOpen	H 26 H OpnLX1	K 0 NoAssign
close	H 6 H ClsNB1	K 0 NoAssign
rimClose	H 34 H PdlMu	K 0 NoAssign
footClose	H 38 Hpdclcs1	K 0 NoAssign
splash	H 47 H SplshT	K 0 NoAssign
pad9	C 34 BellTip	K 0 NoAssign
pad10	P 34 CowB2	K 0 NoAssign

Preset Drum Kit List

No. 9 Ballade

Input Source	Voice-1 Cat./No./Name	Voice-2 Cat./No./Name
pad1	K 11 BD NN04C	K 0 NoAssign
rim1	K 0 NoAssign	K 0 NoAssign
pad2	S 110 S SStck2	K 0 NoAssign
rim2	S 15 OldCan	K 0 NoAssign
pad3	T 1 Dry1 Hi	K 0 NoAssign
rim3	T 6 DRY GM5	K 0 NoAssign
pad4	T 2 Dry1 Mid	K 0 NoAssign
rim4	T 8 DRY GM3	K 0 NoAssign
pad5	T 3 Dry1 Lo	K 0 NoAssign
rim5	T 10 DRY GM1	K 0 NoAssign
pad6	C 19 RideLite	K 0 NoAssign
rim6	C 20 Rider3	K 0 NoAssign
pad7	C 1 CrashB	K 0 NoAssign
rim7	C 2 BriteCrs	K 0 NoAssign
open	H 26 H OpnLX1	K 0 NoAssign
rimOpen	H 26 H OpnLX1	K 0 NoAssign
close	H 26 H OpnLX1	K 0 NoAssign
rimClose	H 34 H PdlMu	K 0 NoAssign
footClose	H 38 Hpdclcs1	K 0 NoAssign
splash	H 48 Hpsplsh1	K 0 NoAssign
pad9	C 33 Bell A	K 0 NoAssign
pad10	P 33 CowB1	K 0 NoAssign

No. 10 BeBop

Input Source	Voice-1 Cat./No./Name	Voice-2 Cat./No./Name
pad1	K 36 BDersko1	K 0 NoAssign
rim1	K 0 NoAssign	K 0 NoAssign
pad2	S 78 Cool Dry	S 17 LiteSnr1
rim2	S 79 OpnRim	K 0 NoAssign
pad3	T 19 Jazz Hi	K 0 NoAssign
rim3	T 24 BrshJzMd	K 0 NoAssign
pad4	T 20 Jazz Mid	K 0 NoAssign
rim4	T 26 BrshJzFl	K 0 NoAssign
pad5	T 22 Jazz Flr	K 0 NoAssign
rim5	s 100 BrshAtak	K 0 NoAssign
pad6	C 23 RidesizA	K 0 NoAssign
rim6	C 24 RidesizB	K 0 NoAssign
pad7	C 38 ChinaHi	K 0 NoAssign
rim7	C 7 FasCrash	K 0 NoAssign
open	H 20 H OpnDW	K 0 NoAssign
rimOpen	H 21 H OpnDWX	K 0 NoAssign
close	H 20 H OpnDW	K 0 NoAssign
rimClose	H 21 H OpnDWX	K 0 NoAssign
footClose	H 31 H Pdl13	K 0 NoAssign
splash	H 48 Hpsplsh1	K 0 NoAssign
pad9	C 35 RidB Drk	K 0 NoAssign
pad10	P 33 CowB1	K 0 NoAssign

No. 11 Andora

Input Source	Voice-1 Cat./No./Name	Voice-2 Cat./No./Name
pad1	K 19 MapleA20	K 36 BDersko1
rim1	P 33 CowB1	K 0 NoAssign
pad2	S 17 LiteSnr1	K 0 NoAssign
rim2	S 79 OpnRim	K 0 NoAssign
pad3	T 11 Maple10	K 0 NoAssign
rim3	T 1 Dry1 Hi	K 0 NoAssign
pad4	T 13 Maple14	K 0 NoAssign
rim4	T 2 Dry1 Mid	K 0 NoAssign
pad5	T 14 Maple16	K 0 NoAssign
rim5	T 4 Dry1 Flr	K 0 NoAssign
pad6	C 16 RideDark	K 0 NoAssign
rim6	C 21 RideRock	K 0 NoAssign
pad7	C 1 CrashB	K 0 NoAssign
rim7	C 37 China	K 0 NoAssign

open	H 23 H OpnL2	K 0 NoAssign
rimOpen	H 25 H OpnLK	K 0 NoAssign
close	H 23 H OpnL2	K 0 NoAssign
rimClose	H 23 H OpnL2	K 0 NoAssign
footClose	H 32 H PdlDW	K 0 NoAssign
splash	H 48 Hpsplsh1	K 0 NoAssign
pad9	C 32 RidB Lit	K 0 NoAssign
pad10	P 33 CowB1	K 0 NoAssign

No. 12 Room Kit

Input Source	Voice-1 Cat./No./Name	Voice-2 Cat./No./Name
pad1	K 19 MapleA20	K 0 NoAssign
rim1	K 0 NoAssign	K 0 NoAssign
pad2	S 85 ParadeS	K 0 NoAssign
rim2	S 79 OpnRim	K 0 NoAssign
pad3	T 75 Room1 Hi	K 0 NoAssign
rim3	T 71 ACTomH	K 0 NoAssign
pad4	T 76 Room1Mid	K 0 NoAssign
rim4	T 72 ACTomM	K 0 NoAssign
pad5	T 78 Room1Flr	K 0 NoAssign
rim5	T 73 ACTomL	K 0 NoAssign
pad6	C 28 SizzlDrk	K 0 NoAssign
rim6	C 24 RidesizB	K 0 NoAssign
pad7	C 1 CrashB	K 0 NoAssign
rim7	C 37 China	K 0 NoAssign
open	H 23 H OpnL2	K 0 NoAssign
rimOpen	H 25 H OpnLK	K 0 NoAssign
close	H 23 H OpnL2	K 0 NoAssign
rimClose	H 23 H OpnL2	K 0 NoAssign
footClose	H 32 H PdlDW	K 0 NoAssign
splash	H 48 Hpsplsh1	K 0 NoAssign
pad9	C 33 Bell A	K 0 NoAssign
pad10	P 33 CowB1	K 0 NoAssign

No. 13 (In)

Input Source	Voice-1 Cat./No./Name	Voice-2 Cat./No./Name
pad1	K 11 BD NN04C	K 0 NoAssign
rim1	K 0 NoAssign	K 0 NoAssign
pad2	S 37 Beauty	K 0 NoAssign
rim2	S 36 BeatyRim	K 0 NoAssign
pad3	T 31 TOMntrIH	K 0 NoAssign
rim3	K 0 NoAssign	K 0 NoAssign
pad4	T 32 TOMntrIM	K 0 NoAssign
rim4	K 0 NoAssign	K 0 NoAssign
pad5	T 33 TOMntrIL	K 0 NoAssign
rim5	K 0 NoAssign	K 0 NoAssign
pad6	C 17 Ridedrk	K 0 NoAssign
rim6	C 19 RideLite	K 0 NoAssign
pad7	C 6 DeepDRK	K 0 NoAssign
rim7	C 41 C Splsh1	K 0 NoAssign
open	H 26 H OpnLX1	K 0 NoAssign
rimOpen	H 26 H OpnLX1	K 0 NoAssign
close	H 11 H TiClis1	K 0 NoAssign
rimClose	H 34 H PdlMu	K 0 NoAssign
footClose	H 38 Hpdclcs1	K 0 NoAssign
splash	H 48 Hpsplsh1	K 0 NoAssign
pad9	C 33 Bell A	K 0 NoAssign
pad10	P 34 CowB2	K 0 NoAssign

No. 14 In&Out

Input Source	Voice-1 Cat./No./Name	Voice-2 Cat./No./Name
pad1	k 1 AnaQuick	K 0 NoAssign
rim1	K 0 NoAssign	K 0 NoAssign
pad2	s 82 S Gate3	K 0 NoAssign
rim2	s 31 RIMpopr	K 0 NoAssign
pad3	e 43 VOLTAGE	K 0 NoAssign

rim3	T 1 Dry1 Hi	K 0 NoAssign
pad4	e 50 D&FRAG20	K 0 NoAssign
rim4	T 1 Dry1 Hi	K 0 NoAssign
pad5	e 33 WINER	K 0 NoAssign
rim5	T 1 Dry1 Hi	K 0 NoAssign
pad6	L 1 DigiTime	K 0 NoAssign
rim6	C 19 RideLite	K 0 NoAssign
pad7	E 11 C Crash	K 0 NoAssign
rim7	C 41 C Splsh1	K 0 NoAssign
open	P 31 CongBe	K 0 NoAssign
rimOpen	H 26 H OpnLX1	K 0 NoAssign
close	P 11 Bongo Hi	K 0 NoAssign
rimClose	H 34 H PdlMu	K 0 NoAssign
footClose	P 39 EthWB	K 0 NoAssign
splash	H 48 Hpsplsh1	K 0 NoAssign
pad9	C 33 Bell A	K 0 NoAssign
pad10	P 34 CowB2	K 0 NoAssign

No. 15 HipFunky

Input Source	Voice-1 Cat./No./Name	Voice-2 Cat./No./Name
pad1	K 8 BD GMH	K 0 NoAssign
rim1	K 0 NoAssign	K 0 NoAssign
pad2	S 14 Hip Hop	K 0 NoAssign
rim2	S 33 12Soprno	K 0 NoAssign
pad3	T 36 Dry2 Mid	K 0 NoAssign
rim3	P 6 AnMaracs	K 0 NoAssign
pad4	T 37 Dry2 Lo	K 0 NoAssign
rim4	P 12 Bongo Lo	K 0 NoAssign
pad5	T 38 Dry2 Flr	K 0 NoAssign
rim5	P 30 CongaS	K 0 NoAssign
pad6	C 23 RidesizA	K 0 NoAssign
rim6	C 16 RideDark	K 0 NoAssign
pad7	C 9 PaperThn	K 0 NoAssign
rim7	C 3 C Crash	K 0 NoAssign
open	H 26 H OpnLX1	K 0 NoAssign
rimOpen	H 26 H OpnLX1	K 0 NoAssign
close	H 1 H Cls01	K 0 NoAssign
rimClose	H 18 H OPMu	K 0 NoAssign
footClose	H 38 Hpdclcs1	K 0 NoAssign
splash	H 48 Hpsplsh1	K 0 NoAssign
pad9	C 36 RidB Rc	K 0 NoAssign
pad10	P 34 CowB2	K 0 NoAssign

No. 16 Dance 1

Input Source	Voice-1 Cat./No./Name	Voice-2 Cat./No./Name
pad1	k 7 BDDance2	K 0 NoAssign
rim1	P 35 CowBAN	K 0 NoAssign
pad2	s 95 Tekk3	K 0 NoAssign
rim2	s 30 HiFive	K 0 NoAssign
pad3	t 21 TEKK 2L	K 0 NoAssign
rim3	P 6 AnMaracs	K 0 NoAssign
pad4	t 23 TEKK 3H	K 0 NoAssign
rim4	P 55 Scrach	K 0 NoAssign
pad5	t 24 TEKK 3M	K 0 NoAssign
rim5	P 55 Scrach	K 0 NoAssign
pad6	C 45 Ride Anl	K 0 NoAssign
rim6	C 32 RidB Lit	K 0 NoAssign
pad7	C 44 AngCym	K 0 NoAssign
rim7	C 41 C Splsh1	K 0 NoAssign
open	H 50 H OpnAn	K 0 NoAssign
rimOpen	P 78 Tambourn	K 0 NoAssign
close	H 3 H ClsA1	K 0 NoAssign
rimClose	H 5 H ClsMu	K 0 NoAssign
footClose	H 4 H ClsA2	K 0 NoAssign
splash	H 48 Hpsplsh1	K 0 NoAssign
pad9	C 32 RidB Lit	K 0 NoAssign
pad10	P 33 CowB1	K 0 NoAssign

No. 17 Dance2

Input Source	Voice-1 Cat./No./Name	Voice-2 Cat./No./Name
pad1	k 12 BDDance9	K 0 NoAssign
rim1	s 12 AnSStick	K 0 NoAssign
pad2	s 17 Dance05	K 0 NoAssign
rim2	s 19 Elektrik	K 0 NoAssign
pad3	t 41 ElectrH	K 0 NoAssign
rim3	P 56 Shake1	K 0 NoAssign
pad4	t 42 ElectrM	K 0 NoAssign
rim4	P 52 Maracas3	K 0 NoAssign
pad5	t 43 ElectrL	K 0 NoAssign
rim5	P 55 Scrach	K 0 NoAssign
pad6	C 45 Ride Anl	K 0 NoAssign
rim6	C 32 RidB Lit	K 0 NoAssign
pad7	C 44 AngCym	K 0 NoAssign
rim7	C 42 C Splsh2	K 0 NoAssign
open	H 50 H OpnAn	K 0 NoAssign
rimOpen	P 78 Tambourn	K 0 NoAssign
close	t 43 ElectrL	K 0 NoAssign
rimClose	H 5 H ClsMu	K 0 NoAssign
footClose	H 4 H ClsA2	K 0 NoAssign
splash	H 48 Hpsplsh1	K 0 NoAssign
pad9	C 32 RidB Lit	K 0 NoAssign
pad10	P 33 CowB1	K 0 NoAssign

No. 18 SoDance

Input Source	Voice-1 Cat./No./Name	Voice-2 Cat./No./Name
pad1	k 13 BDlong1	K 19 MapleA20
rim1	K 0 NoAssign	K 0 NoAssign
pad2	s 4 Analog H	K 0 NoAssign
rim2	s 19 Elektrik	K 0 NoAssign
pad3	E 15 CoolSA	K 0 NoAssign
rim3	T 71 ACTomH	K 0 NoAssign
pad4	E 15 CoolSA	K 0 NoAssign
rim4	T 72 ACTomM	K 0 NoAssign
pad5	E 83 USS	t 44 ElectrF
rim5	T 73 ACTomL	K 0 NoAssign
pad6	C 18 Ride EM	K 0 NoAssign
rim6	C 13 C FX02	K 0 NoAssign
pad7	E 2 Ambush	K 0 NoAssign
rim7	C 47 HCym2	K 0 NoAssign
open	H 49 H OpnAMu	K 0 NoAssign
rimOpen	H 50 H OpnAn	K 0 NoAssign
close	H 12 H TiCls2	K 0 NoAssign
rimClose	H 51 H OpnLA1	K 0 NoAssign
footClose	t 51 ETMooRL	K 0 NoAssign
splash	H 46 H SplNB	K 0 NoAssign
pad9	P 35 CowBAN	K 0 NoAssign
pad10	P 33 CowB1	K 0 NoAssign

No. 19 Manh

Input Source	Voice-1 Cat./No./Name	Voice-2 Cat./No./Name
pad1	K 6 BD DRY 3	e 39 PEEPER
rim1	K 0 NoAssign	K 0 NoAssign
pad2	S 1 Loosy	K 0 NoAssign
rim2	S 1 Loosy	K 0 NoAssign
pad3	E 36 HipNs	K 0 NoAssign
rim3	T 6 DRY GM5	K 0 NoAssign
pad4	e 64 RUNNER	K 0 NoAssign
rim4	T 8 DRY GM3	K 0 NoAssign
pad5	e 74 Vocal04	K 0 NoAssign
rim5	T 10 DRY GM1	K 0 NoAssign
pad6	C 45 Ride Anl	K 0 NoAssign
rim6	C 20 Rider3	K 0 NoAssign
pad7	C 44 AngCym	K 0 NoAssign
rim7	C 43 C FX01	K 0 NoAssign

open	H 26 H OpnLX1	K 0 NoAssign
rimOpen	H 26 H OpnLX1	K 0 NoAssign
close	H 1 H Cls01	K 0 NoAssign
rimClose	H 34 H PdlMu	K 0 NoAssign
footClose	H 38 Hpdcls1	K 0 NoAssign
splash	H 48 Hpsplsh1	K 0 NoAssign
pad9	C 33 Bell A	K 0 NoAssign
pad10	P 33 CowB1	K 0 NoAssign

No. 20 D@RK

Input Source	Voice-1 Cat./No./Name	Voice-2 Cat./No./Name
pad1	k 12 BDDance9	k 17 Sub2
rim1	K 0 NoAssign	K 0 NoAssign
pad2	s 7 AnalogL1	K 0 NoAssign
rim2	s 43 AnaWee	K 0 NoAssign
pad3	t 24 TEKK 3M	K 0 NoAssign
rim3	T 6 DRY GM5	K 0 NoAssign
pad4	t 25 TEKK 3L	K 0 NoAssign
rim4	T 8 DRY GM3	K 0 NoAssign
pad5	e 64 RUNNER	K 0 NoAssign
rim5	T 10 DRY GM1	K 0 NoAssign
pad6	C 45 Ride Anl	K 0 NoAssign
rim6	C 20 Rider3	K 0 NoAssign
pad7	C 1 CrashB	K 0 NoAssign
rim7	C 2 BriteCrs	K 0 NoAssign
open	H 50 H OpnAn	K 0 NoAssign
rimOpen	H 26 H OpnLX1	K 0 NoAssign
close	H 50 H OpnAn	K 0 NoAssign
rimClose	H 34 H PdlMu	K 0 NoAssign
footClose	H 50 H OpnAn	K 0 NoAssign
splash	H 49 H OpnAMu	K 0 NoAssign
pad9	C 33 Bell A	K 0 NoAssign
pad10	P 33 CowB1	K 0 NoAssign

No. 21 Oh!No!

Input Source	Voice-1 Cat./No./Name	Voice-2 Cat./No./Name
pad1	k 6 BDDance1	K 0 NoAssign
rim1	K 0 NoAssign	K 0 NoAssign
pad2	s 57 Eno rim	K 0 NoAssign
rim2	s 58 Enotype	K 0 NoAssign
pad3	E 58 OrcHt1	K 0 NoAssign
rim3	T 6 DRY GM5	K 0 NoAssign
pad4	E 58 OrcHt1	K 0 NoAssign
rim4	T 8 DRY GM3	K 0 NoAssign
pad5	L 14 SwingnL	L 20 FactoryLP
rim5	T 10 DRY GM1	K 0 NoAssign
pad6	E 58 OrcHt1	K 0 NoAssign
rim6	C 20 Rider3	K 0 NoAssign
pad7	C 13 C FX02	C 10 ReverseC
rim7	C 13 C FX02	K 0 NoAssign
open	E 57 OrchSmsh	K 0 NoAssign
rimOpen	H 26 H OpnLX1	K 0 NoAssign
close	E 10 BuzzyWak	K 0 NoAssign
rimClose	E 10 BuzzyWak	K 0 NoAssign
footClose	P 59 SiBell	K 0 NoAssign
splash	C 48 HCymClsL	K 0 NoAssign
pad9	P 55 Scrach	K 0 NoAssign
pad10	P 45 HIQ	K 0 NoAssign

No. 22 Latin/Tm

Input Source	Voice-1 Cat./No./Name	Voice-2 Cat./No./Name
pad1	K 29 BD ROOM5	K 0 NoAssign
rim1	K 0 NoAssign	K 0 NoAssign
pad2	S 31 MickCJ8S	K 0 NoAssign
rim2	S 120 Latinrim	K 0 NoAssign
pad3	P 81 TimbH	K 0 NoAssign

rim3	P 27 CongaMV	K 0 NoAssign
pad4	P 82 TimbL	K 0 NoAssign
rim4	P 80 Timb	K 0 NoAssign
pad5	P 29 CongaO	K 0 NoAssign
rim5	P 51 Maracas2	K 0 NoAssign
pad6	C 19 RideLite	K 0 NoAssign
rim6	C 20 Rider3	K 0 NoAssign
pad7	C 1 CrashB	K 0 NoAssign
rim7	C 2 BriteCrs	K 0 NoAssign
open	P 2 AgogoH1	K 0 NoAssign
rimOpen	H 26 H OpnLX1	K 0 NoAssign
close	P 1 XfadeTri	K 0 NoAssign
rimClose	H 34 H PdlMu	K 0 NoAssign
footClose	P 33 CowB1	K 0 NoAssign
splash	H 1 H Cls01	K 0 NoAssign
pad9	C 33 Bell A	K 0 NoAssign
pad10	P 34 CowB2	K 0 NoAssign

No. 23 LatinPer

Input Source	Voice-1 Cat./No./Name	Voice-2 Cat./No./Name
pad1	K 1 2HedMed1	K 0 NoAssign
rim1	P 12 Bongo Lo	K 0 NoAssign
pad2	P 21 Conga	K 0 NoAssign
rim2	P 25 CongaH	K 0 NoAssign
pad3	P 81 TimbH	K 0 NoAssign
rim3	P 33 CowB1	K 0 NoAssign
pad4	P 82 TimbL	K 0 NoAssign
rim4	P 83 TimCas	K 0 NoAssign
pad5	P 89 Udo H	K 0 NoAssign
rim5	P 70 TablaO	K 0 NoAssign
pad6	P 3 AgogoH2	K 0 NoAssign
rim6	P 3 AgogoH2	K 0 NoAssign
pad7	P 38 Cuical	K 0 NoAssign
rim7	C 3 C Crash	K 0 NoAssign
open	P 21 Conga	K 0 NoAssign
rimOpen	P 26 CongaM	K 0 NoAssign
close	P 49 Log L	K 0 NoAssign
rimClose	P 19 Clvs	K 0 NoAssign
footClose	P 90 Udo L	K 0 NoAssign
splash	P 79 Tambrn	K 0 NoAssign
pad9	P 86 Triang	K 0 NoAssign
pad10	P 11 Bongo Hi	K 0 NoAssign

No. 24 Zebulon

Input Source	Voice-1 Cat./No./Name	Voice-2 Cat./No./Name
pad1	K 14 SoTight	K 0 NoAssign
rim1	K 0 NoAssign	K 0 NoAssign
pad2	S 1 Loosy	K 0 NoAssign
rim2	S 40 BuzRgRim	K 0 NoAssign
pad3	T 79 Room2 Hi	K 0 NoAssign
rim3	K 0 NoAssign	K 0 NoAssign
pad4	T 80 Room2Mid	K 0 NoAssign
rim4	K 0 NoAssign	K 0 NoAssign
pad5	T 82 Room2Flr	K 0 NoAssign
rim5	K 0 NoAssign	K 0 NoAssign
pad6	C 24 RidesizB	K 0 NoAssign
rim6	C 33 Bell A	K 0 NoAssign
pad7	C 3 C Crash	K 0 NoAssign
rim7	C 1 CrashB	K 0 NoAssign
open	H 29 HHRoKopn	K 0 NoAssign
rimOpen	H 18 H OPMu	K 0 NoAssign
close	H 10 H QOpn13	K 0 NoAssign
rimClose	H 5 H ClsMu	K 0 NoAssign
footClose	H 31 H Pdl13	K 0 NoAssign
splash	H 48 Hpsplsh1	K 0 NoAssign
pad9	C 32 RidB Lit	K 0 NoAssign
pad10	P 33 CowB1	K 0 NoAssign

Preset Drum Kit List

No. 25 World

Input Source	Voice-1 Cat./No./Name	Voice-2 Cat./No./Name
pad1	P 13 Bongo Mu	K 0 NoAssign
rim1	P 80 Timb	K 0 NoAssign
pad2	P 48 Log H	K 0 NoAssign
rim2	P 39 EthWB	K 0 NoAssign
pad3	P 29 CongaO	K 0 NoAssign
rim3	P 11 Bongo Hi	K 0 NoAssign
pad4	P 29 CongaO	K 0 NoAssign
rim4	K 0 NoAssign	K 0 NoAssign
pad5	P 29 CongaO	K 0 NoAssign
rim5	P 48 Log H	K 0 NoAssign
pad6	P 80 Timb	K 0 NoAssign
rim6	P 80 Timb	K 0 NoAssign
pad7	P 25 CongaH	K 0 NoAssign
rim7	P 82 TimbL	K 0 NoAssign
open	P 25 CongaH	K 0 NoAssign
rimOpen	H 18 H OPMu	K 0 NoAssign
close	P 30 CongaS	K 0 NoAssign
rimClose	H 5 H ClsMu	K 0 NoAssign
footClose	P 30 CongaS	K 0 NoAssign
splash	H 48 Hpsplsh1	K 0 NoAssign
pad9	P 11 Bongo Hi	K 0 NoAssign
pad10	P 24 CongaG	K 0 NoAssign

No. 26 Reggae

Input Source	Voice-1 Cat./No./Name	Voice-2 Cat./No./Name
pad1	K 7 BD DRY 4	K 0 NoAssign
rim1	P 33 CowB1	K 0 NoAssign
pad2	S 33 12Soprno	K 0 NoAssign
rim2	S 110 S SStck2	K 0 NoAssign
pad3	P 81 TimbH	K 0 NoAssign
rim3	C 38 ChinaHi	K 0 NoAssign
pad4	P 82 TimbL	K 0 NoAssign
rim4	P 19 Clvs	K 0 NoAssign
pad5	t 32 E Tom5	K 0 NoAssign
rim5	P 90 Udo L	K 0 NoAssign
pad6	C 30 SizzLit	K 0 NoAssign
rim6	C 19 RideLite	K 0 NoAssign
pad7	C 3 C Crash	K 0 NoAssign
rim7	C 41 C Splsh1	K 0 NoAssign
open	H 10 H QOPn13	K 0 NoAssign
rimOpen	H 26 H OpnLX1	K 0 NoAssign
close	H 2 H Cls13	K 0 NoAssign
rimClose	H 34 H PdlImu	K 0 NoAssign
footClose	H 31 H Pdl13	K 0 NoAssign
splash	H 47 H Splsh1	K 0 NoAssign
pad9	C 32 RidB Lit	K 0 NoAssign
pad10	P 26 CongaM	K 0 NoAssign

No. 27 Tabla

Input Source	Voice-1 Cat./No./Name	Voice-2 Cat./No./Name
pad1	P 90 Udo L	K 0 NoAssign
rim1	P 2 AgogoH1	K 0 NoAssign
pad2	P 68 TablaM	K 0 NoAssign
rim2	P 26 CongaM	K 0 NoAssign
pad3	P 69 TablaN	K 0 NoAssign
rim3	P 62 Tabla B	K 0 NoAssign
pad4	P 70 TablaO	K 0 NoAssign
rim4	P 63 Tabla BL	K 0 NoAssign
pad5	P 67 TablaH	K 0 NoAssign
rim5	P 65 Tabla BV	K 0 NoAssign
pad6	P 66 Tabla OV	K 0 NoAssign
rim6	C 33 Bell A	K 0 NoAssign
pad7	P 89 Udo H	K 0 NoAssign
rim7	P 88 Udo F	K 0 NoAssign

open	P 29 CongaO	K 0 NoAssign
rimOpen	H 23 H OpnL2	K 0 NoAssign
close	P 30 CongaS	K 0 NoAssign
rimClose	H 1 H Cls01	K 0 NoAssign
footClose	P 46 JingBell	K 0 NoAssign
splash	H 46 H SplNB	K 0 NoAssign
pad9	C 33 Bell A	K 0 NoAssign
pad10	P 3 AgogoH2	K 0 NoAssign

No. 28 Cocktail

Input Source	Voice-1 Cat./No./Name	Voice-2 Cat./No./Name
pad1	T 32 TOMntrIM	K 0 NoAssign
rim1	K 0 NoAssign	K 0 NoAssign
pad2	S 31 MickCJ8S	K 0 NoAssign
rim2	S 74 TrashRIM	K 0 NoAssign
pad3	T 19 Jazz Hi	K 0 NoAssign
rim3	P 81 TimbH	K 0 NoAssign
pad4	T 19 Jazz Hi	K 0 NoAssign
rim4	P 81 TimbH	K 0 NoAssign
pad5	P 33 CowB1	K 0 NoAssign
rim5	C 39 MinChina	K 0 NoAssign
pad6	C 19 RideLite	K 0 NoAssign
rim6	C 19 RideLite	K 0 NoAssign
pad7	C 41 C Splsh1	K 0 NoAssign
rim7	C 9 PaperThn	K 0 NoAssign
open	H 27 H OpnMU	K 0 NoAssign
rimOpen	H 18 H OPMu	K 0 NoAssign
close	H 8 H ClsTc3	K 0 NoAssign
rimClose	H 5 H ClsMu	K 0 NoAssign
footClose	H 34 H PdlImu	K 0 NoAssign
splash	P 79 Tambrn	K 0 NoAssign
pad9	C 32 RidB Lit	K 0 NoAssign
pad10	P 33 CowB1	K 0 NoAssign

No. 29 JamKit99

Input Source	Voice-1 Cat./No./Name	Voice-2 Cat./No./Name
pad1	k 17 Sub2	k 30 MtlPoint
rim1	K 0 NoAssign	K 0 NoAssign
pad2	S 18 Tosh Sn	k 30 MtlPoint
rim2	e 54 DUCKSTER	K 0 NoAssign
pad3	e 41 D&FRAG11	K 0 NoAssign
rim3	t 28 AnaIndsM	K 0 NoAssign
pad4	e 65 RADAMACU	K 0 NoAssign
rim4	t 27 AnaIndsH	K 0 NoAssign
pad5	e 18 JNGBASS8	e 30 SEAMNSTR
rim5	t 30 AnaIndsF	K 0 NoAssign
pad6	e 69 WAKX PAD	C 10 ReverseC
rim6	C 45 Ride Anl	K 0 NoAssign
pad7	e 58 GOWAH	K 0 NoAssign
rim7	C 44 AngCym	K 0 NoAssign
open	H 23 H OpnL2	K 0 NoAssign
rimOpen	H 25 H OpnLK	K 0 NoAssign
close	H 24 H OpnL3	K 0 NoAssign
rimClose	H 23 H OpnL2	K 0 NoAssign
footClose	H 32 H PdlDW	K 0 NoAssign
splash	H 48 Hpsplsh1	K 0 NoAssign
pad9	C 33 Bell A	K 0 NoAssign
pad10	P 33 CowB1	K 0 NoAssign

No. 30 GoezOn!?

Input Source	Voice-1 Cat./No./Name	Voice-2 Cat./No./Name
pad1	k 12 BDDance9	e 20 BDSUBSNK
rim1	K 0 NoAssign	K 0 NoAssign
pad2	s 24 Brsh H	s 18 Dance06
rim2	s 6 AnalogH1	K 0 NoAssign
pad3	s 3 AnaHit	e 22 SPIKER

rim3	T 0 NoAssign	K 0 NoAssign
pad4	H 17 HHbrtcls	K 0 NoAssign
rim4	T 0 NoAssign	K 0 NoAssign
pad5	L 9 SNAPLOOP	K 0 NoAssign
rim5	T 0 NoAssign	K 0 NoAssign
pad6	e 74 Vocal04	K 0 NoAssign
rim6	C 0 NoAssign	K 0 NoAssign
pad7	e 53 DOPPLER	K 0 NoAssign
rim7	E 33 HandyDad	K 0 NoAssign
open	H 23 H OpnL2	K 0 NoAssign
rimOpen	H 25 H OpnLK	K 0 NoAssign
close	H 24 H OpnL3	K 0 NoAssign
rimClose	H 23 H OpnL2	K 0 NoAssign
footClose	H 31 H Pdl13	K 0 NoAssign
splash	H 48 Hpsplsh1	K 0 NoAssign
pad9	E 13 CBRadi	K 0 NoAssign
pad10	P 33 CowB1	K 0 NoAssign

No. 31 InDaHood

Input Source	Voice-1 Cat./No./Name	Voice-2 Cat./No./Name
pad1	K 2 2HedMed2	K 28 BD ROOM2
rim1	K 0 NoAssign	K 0 NoAssign
pad2	S 5 Binky	s 120 Manycure
rim2	S 28 RIMhipop	K 0 NoAssign
pad3	T 1 Dry1 Hi	K 0 NoAssign
rim3	T 11 Maple10	K 0 NoAssign
pad4	C 16 RideDark	C 29 Sizzler
rim4	C 6 DeepDRK	C 18 Ride'EM
pad5	T 3 Dry1 Lo	K 0 NoAssign
rim5	T 13 Maple14	K 0 NoAssign
pad6	C 39 MinChina	K 0 NoAssign
rim6	C 33 Bell A	K 0 NoAssign
pad7	P 41 GONG	K 0 NoAssign
rim7	C 11 SoftRoll	K 0 NoAssign
open	H 24 H OpnL3	K 0 NoAssign
rimOpen	H 25 H OpnLK	K 0 NoAssign
close	H 17 HHbrtcls	K 0 NoAssign
rimClose	H 23 H OpnL2	K 0 NoAssign
footClose	H 31 H Pdl13	K 0 NoAssign
splash	H 48 Hpsplsh1	K 0 NoAssign
pad9	C 40 Clusher	K 0 NoAssign
pad10	P 33 CowB1	K 0 NoAssign

No. 32 GroovKit

Input Source	Voice-1 Cat./No./Name	Voice-2 Cat./No./Name
pad1	K 4 BD DRY 1	K 30 MapleAmb
rim1	K 0 NoAssign	K 0 NoAssign
pad2	s 120 Manycure	S 8 MapleV65
rim2	S 28 RIMhipop	K 0 NoAssign
pad3	T 1 Dry1 Hi	K 0 NoAssign
rim3	T 11 Maple10	K 0 NoAssign
pad4	C 16 RideDark	C 29 Sizzler
rim4	C 8 FastCras	C 38 ChinaHi
pad5	T 3 Dry1 Lo	K 0 NoAssign
rim5	T 13 Maple14	K 0 NoAssign
pad6	● pad song : 90 BsGroov	
rim6	C 33 Bell A	K 0 NoAssign
pad7	● pad song : 91 D&B07	
rim7	C 11 SoftRoll	K 0 NoAssign
open	H 24 H OpnL3	K 0 NoAssign
rimOpen	H 25 H OpnLK	K 0 NoAssign
close	H 17 HHbrtcls	K 0 NoAssign
rimClose	H 23 H OpnL2	K 0 NoAssign
footClose	H 31 H Pdl13	K 0 NoAssign
splash	H 48 Hpsplsh1	K 0 NoAssign
pad9	C 40 Clusher	K 0 NoAssign
pad10	P 33 CowB1	K 0 NoAssign

No. 33 Bs. @ Base

Input Source	Voice-1 Cat./No./Name	Voice-2 Cat./No./Name
pad1	k 32 Walkik	k 18 Sub3
rim1	K 0 NoAssign	K 0 NoAssign
pad2	s 118 Shotgun	e 8 JNGLSN8
rim2	s 80 S Gate1	K 0 NoAssign
pad3	● pad song : 89 HornGrv	
rim3	K 0 NoAssign	K 0 NoAssign
pad4	L 4 LITELoop	K 0 NoAssign
rim4	K 0 NoAssign	K 0 NoAssign
pad5	● pad song : 88 Jko?Naa	
rim5	K 0 NoAssign	K 0 NoAssign
pad6	e 34 DOOMED	K 0 NoAssign
rim6	e 37 MOSHER	K 0 NoAssign
pad7	e 45 GRONKER	K 0 NoAssign
rim7	e 66 UMK 47	K 0 NoAssign
open	H 18 H OPMu	K 0 NoAssign
rimOpen	H 18 H OPMu	K 0 NoAssign
close	H 5 H ClsMu	K 0 NoAssign
rimClose	H 5 H ClsMu	K 0 NoAssign
footClose	H 34 H PdlImu	K 0 NoAssign
splash	H 48 Hpsplsh1	K 0 NoAssign
pad9	C 32 RidB Lit	K 0 NoAssign
pad10	P 33 CowB1	K 0 NoAssign

No. 34 JungleNY

Input Source	Voice-1 Cat./No./Name	Voice-2 Cat./No./Name
pad1	k 10 BDdance5	K 0 NoAssign
rim1	K 0 NoAssign	K 0 NoAssign
pad2	e 82 FRAG05	K 0 NoAssign
rim2	e 38 D&BFRAG8	K 0 NoAssign
pad3	e 12 JNGBASS2	K 0 NoAssign
rim3	K 0 NoAssign	K 0 NoAssign
pad4	e 81 FRAG11	K 0 NoAssign
rim4	K 0 NoAssign	K 0 NoAssign
pad5	e 41 D&FRAG11	K 0 NoAssign
rim5	K 0 NoAssign	K 0 NoAssign
pad6	C 24 RidesizB	K 0 NoAssign
rim6	e 36 TRANQUL	K 0 NoAssign
pad7	e 36 TRANQUL	K 0 NoAssign
rim7	e 36 TRANQUL	K 0 NoAssign
open	H 30 HHopen#1	K 0 NoAssign
rimOpen	H 18 H OPMu	K 0 NoAssign
close	H 17 HHbrtcls	K 0 NoAssign
rimClose	H 5 H ClsMu	K 0 NoAssign
footClose	H 36 H PdTit	K 0 NoAssign
splash	H 43 FTsplRK2	K 0 NoAssign
pad9	C 32 RidB Lit	K 0 NoAssign
pad10	P 33 CowB1	K 0 NoAssign

No. 35 Snapkit

Input Source	Voice-1 Cat./No./Name	Voice-2 Cat./No./Name
pad1	e 16 JNGBASS6	K 0 NoAssign
rim1	K 0 NoAssign	K 0 NoAssign
pad2	e 56 PANKY	K 0 NoAssign
rim2	e 84 FRAG20	K 0 NoAssign
pad3	e 24 PULSAR2	K 0 NoAssign
rim3	K 0 NoAssign	K 0 NoAssign
pad4	e 40 WYZOG	K 0 NoAssign
rim4	K 0 NoAssign	K 0 NoAssign
pad5	L 9 SNAPLOOP	K 0 NoAssign
rim5	K 0 NoAssign	K 0 NoAssign
pad6	E 44 INDride	K 0 NoAssign
rim6	e 64 RUNNER	K 0 NoAssign
pad7	e 39 PEEPER	K 0 NoAssign
rim7	e 55 TAMTAMY	K 0 NoAssign

open	H 50 H OpnAn	K 0 NoAssign
rimOpen	H 18 H OPMu	K 0 NoAssign
close	H 3 H ClsA1	K 0 NoAssign
rimClose	H 5 H ClsMu	K 0 NoAssign
footClose	H 36 H PdTit	K 0 NoAssign
splash	H 43 FTsplRK2	K 0 NoAssign
pad9	C 32 RidB Lit	K 0 NoAssign
pad10	P 33 CowB1	K 0 NoAssign

No. 36 JumpBack

Input Source	Voice-1 Cat./No./Name	Voice-2 Cat./No./Name
pad1	K 30 MapleAmb	K 0 NoAssign
rim1	K 0 NoAssign	K 0 NoAssign
pad2	e 3 JNGLSN3	K 0 NoAssign
rim2	S 28 RIMhipop	K 0 NoAssign
pad3	E 80 TungDrum	K 0 NoAssign
rim3	K 0 NoAssign	K 0 NoAssign
pad4	● pad song : 83 Photon	
rim4	K 0 NoAssign	K 0 NoAssign
pad5	● pad song : 84 Ganoosh	
rim5	K 0 NoAssign	K 0 NoAssign
pad6	E 45 INDride2	K 0 NoAssign
rim6	e 42 SCRUNCH	K 0 NoAssign
pad7	C 4 C CrshAC	K 0 NoAssign
rim7	C 3 C Crash	K 0 NoAssign
open	H 29 HHRoKopn	K 0 NoAssign
rimOpen	H 18 H OPMu	K 0 NoAssign
close	H 2 H Cls13	K 0 NoAssign
rimClose	H 5 H ClsMu	K 0 NoAssign
footClose	H 36 H PdTit	K 0 NoAssign
splash	H 43 FTsplRK2	K 0 NoAssign
pad9	C 32 RidB Lit	K 0 NoAssign
pad10	P 33 CowB1	K 0 NoAssign

No. 37 MondoKit

Input Source	Voice-1 Cat./No./Name	Voice-2 Cat./No./Name
pad1	K 33 BD MONDO	K 0 NoAssign
rim1	K 0 NoAssign	K 0 NoAssign
pad2	e 5 JNGLSN5	K 0 NoAssign
rim2	S 118 SnareLes	K 0 NoAssign
pad3	t 8 Ana 2flr	K 0 NoAssign
rim3	K 0 NoAssign	K 0 NoAssign
pad4	● pad song : 79 Peaceout	
rim4	K 0 NoAssign	K 0 NoAssign
pad5	● pad song : 80 Kinetic	
rim5	K 0 NoAssign	K 0 NoAssign
pad6	C 36 RidB Rc	K 0 NoAssign
rim6	e 37 MOSHER	K 0 NoAssign
pad7	C 5 CrshDRK	K 0 NoAssign
rim7	E 40 INDcrash	K 0 NoAssign
open	H 25 H OpnLK	K 0 NoAssign
rimOpen	H 18 H OPMu	K 0 NoAssign
close	H 7 H ClsTc1	K 0 NoAssign
rimClose	H 5 H ClsMu	K 0 NoAssign
footClose	H 41 Hpdclcs4	K 0 NoAssign
splash	H 43 FTsplRK2	K 0 NoAssign
pad9	C 32 RidB Lit	K 0 NoAssign
pad10	P 33 CowB1	K 0 NoAssign

No. 38 Torqkit

Input Source	Voice-1 Cat./No./Name	Voice-2 Cat./No./Name
pad1	K 24 2HeadHi	K 0 NoAssign
rim1	K 0 NoAssign	K 0 NoAssign
pad2	e 48 JNGSN11	K 0 NoAssign
rim2	e 8 JNGLSN8	K 0 NoAssign
pad3	T 19 Jazz Hi	K 0 NoAssign

rim3	K 0 NoAssign	K 0 NoAssign
pad4	● pad song : 85 Babaj	
rim4	K 0 NoAssign	K 0 NoAssign
pad5	● pad song : 86 NxtGene.	
rim5	K 0 NoAssign	K 0 NoAssign
pad6	C 18 Ride'EM	K 0 NoAssign
rim6	e 59 DEEPDIVE	K 0 NoAssign
pad7	P 21 Conga	K 0 NoAssign
rim7	C 40 Clusher	K 0 NoAssign
open	H 50 H OpnAn	K 0 NoAssign
rimOpen	H 18 H OPMu	K 0 NoAssign
close	H 3 H ClsA1	K 0 NoAssign
rimClose	H 5 H ClsMu	K 0 NoAssign
footClose	H 36 H PdTit	K 0 NoAssign
splash	H 43 FTsplRK2	K 0 NoAssign
pad9	C 32 RidB Lit	K 0 NoAssign
pad10	P 33 CowB1	K 0 NoAssign

No. 38 Mystery

Input Source	Voice-1 Cat./No./Name	Voice-2 Cat./No./Name
pad1	k 24 BDNIN1	K 0 NoAssign
rim1	K 0 NoAssign	K 0 NoAssign
pad2	e 76 FRAG14	e 82 FRAG05
rim2	e 1 JNGLSN1	K 0 NoAssign
pad3	● pad song : 93 Suspens2	
rim3	K 0 NoAssign	K 0 NoAssign
pad4	● pad song : 95 0	
rim4	K 0 NoAssign	K 0 NoAssign
pad5	● pad song : 94 Suspens3	
rim5	K 0 NoAssign	K 0 NoAssign
pad6	C 30 SizzLit	K 0 NoAssign
rim6	C 19 RideLite	K 0 NoAssign
pad7	C 3 C Crash	C 37 China
rim7	C 1 CrashB	C 37 China
open	H 18 H OPMu	K 0 NoAssign
rimOpen	H 18 H OPMu	K 0 NoAssign
close	H 5 H ClsMu	K 0 NoAssign
rimClose	H 5 H ClsMu	K 0 NoAssign
footClose	H 34 H PdlImu	K 0 NoAssign
splash	H 48 Hpsplsh1	K 0 NoAssign
pad9	C 32 RidB Lit	K 0 NoAssign
pad10	e 46 SEMILOOP	K 0 NoAssign

No. 40 GM std 1

Input Source	Voice-1 Cat./No./Name	Voice-2 Cat./No./Name
pad1	K 17 BDafatty1	K 0 NoAssign
rim1	K 0 NoAssign	K 0 NoAssign
pad2	S 1 Loosy	K 0 NoAssign
rim2	S 79 OpnRim	K 0 NoAssign
pad3	T 6 DRY GM5	K 0 NoAssign
rim3	T 6 DRY GM5	K 0 NoAssign
pad4	T 7 DRY GM4	K 0 NoAssign
rim4	T 7 DRY GM4	K 0 NoAssign
pad5	T 9 DRY GM2	K 0 NoAssign
rim5	T 9 DRY GM2	K 0 NoAssign
pad6	C 30 SizzLit	K 0 NoAssign
rim6	C 19 RideLite	K 0 NoAssign
pad7	C 3 C Crash	K 0 NoAssign
rim7	C 1 CrashB	K 0 NoAssign
open	H 18 H OPMu	K 0 NoAssign
rimOpen	H 18 H OPMu	K 0 NoAssign
close	H 5 H ClsMu	K 0 NoAssign
rimClose	H 5 H ClsMu	K 0 NoAssign
footClose	H 34 H PdlImu	K 0 NoAssign
splash	H 48 Hpsplsh1	K 0 NoAssign
pad9	C 32 RidB Lit	K 0 NoAssign
pad10	P 33 CowB1	K 0 NoAssign

Preset Drum Kit List

No. 41 GM std 2

Input Source	Voice-1 Cat./No./Name	Voice-2 Cat./No./Name
pad1	K 19 MapleA20	K 0 NoAssign
rim1	K 0 NoAssign	K 0 NoAssign
pad2	S 98 Steel65	K 0 NoAssign
rim2	S 91 OpnRimC	K 0 NoAssign
pad3	T 6 DRY GM5	K 0 NoAssign
rim3	T 6 DRY GM5	K 0 NoAssign
pad4	T 7 DRY GM4	K 0 NoAssign
rim4	T 7 DRY GM4	K 0 NoAssign
pad5	T 9 DRY GM2	K 0 NoAssign
rim5	T 9 DRY GM2	K 0 NoAssign
pad6	C 30 SizzLit	K 0 NoAssign
rim6	C 19 RideLite	K 0 NoAssign
pad7	C 3 C Crash	K 0 NoAssign
rim7	C 1 CrashB	K 0 NoAssign
open	H 18 H OPMu	K 0 NoAssign
rimOpen	H 18 H OPMu	K 0 NoAssign
close	H 5 H ClsMu	K 0 NoAssign
rimClose	H 5 H ClsMu	K 0 NoAssign
footClose	H 34 H PdlMu	K 0 NoAssign
splash	H 48 Hpsplsh1	K 0 NoAssign
pad9	C 32 RidB Lit	K 0 NoAssign
pad10	P 33 CowB1	K 0 NoAssign

No. 42 GM room

Input Source	Voice-1 Cat./No./Name	Voice-2 Cat./No./Name
pad1	K 34 BDbasc2	K 0 NoAssign
rim1	K 0 NoAssign	K 0 NoAssign
pad2	S 1 Loosy	K 0 NoAssign
rim2	S 79 OpnRim	K 0 NoAssign
pad3	T 52 Room 5	K 0 NoAssign
rim3	T 52 Room 5	K 0 NoAssign
pad4	T 53 Room 4	K 0 NoAssign
rim4	T 53 Room 4	K 0 NoAssign
pad5	T 55 Room 2	K 0 NoAssign
rim5	T 55 Room 2	K 0 NoAssign
pad6	C 30 SizzLit	K 0 NoAssign
rim6	C 19 RideLite	K 0 NoAssign
pad7	C 3 C Crash	K 0 NoAssign
rim7	C 1 CrashB	K 0 NoAssign
open	H 18 H OPMu	K 0 NoAssign
rimOpen	H 18 H OPMu	K 0 NoAssign
close	H 5 H ClsMu	K 0 NoAssign
rimClose	H 5 H ClsMu	K 0 NoAssign
footClose	H 34 H PdlMu	K 0 NoAssign
splash	H 48 Hpsplsh1	K 0 NoAssign
pad9	C 32 RidB Lit	K 0 NoAssign
pad10	P 33 CowB1	K 0 NoAssign

No. 43 GM rock

Input Source	Voice-1 Cat./No./Name	Voice-2 Cat./No./Name
pad1	K 22 Bdvman	K 0 NoAssign
rim1	K 0 NoAssign	K 0 NoAssign
pad2	S 97 Brass55	S 47 RIMnatrl
rim2	S 79 OpnRim	K 0 NoAssign
pad3	T 58 Rock 5	K 0 NoAssign
rim3	T 58 Rock 5	K 0 NoAssign
pad4	T 59 Rock 4	K 0 NoAssign
rim4	T 59 Rock 4	K 0 NoAssign
pad5	T 61 Rock 2	K 0 NoAssign
rim5	T 61 Rock 2	K 0 NoAssign
pad6	C 30 SizzLit	K 0 NoAssign
rim6	C 19 RideLite	K 0 NoAssign
pad7	C 3 C Crash	K 0 NoAssign
rim7	C 1 CrashB	K 0 NoAssign

open	H 18 H OPMu	K 0 NoAssign
rimOpen	H 18 H OPMu	K 0 NoAssign
close	H 5 H ClsMu	K 0 NoAssign
rimClose	H 5 H ClsMu	K 0 NoAssign
footClose	H 34 H PdlMu	K 0 NoAssign
splash	H 48 Hpsplsh1	K 0 NoAssign
pad9	C 32 RidB Lit	K 0 NoAssign
pad10	P 33 CowB1	K 0 NoAssign

No. 44 GM elec.

Input Source	Voice-1 Cat./No./Name	Voice-2 Cat./No./Name
pad1	K 42 BD GateM	K 0 NoAssign
rim1	K 0 NoAssign	K 0 NoAssign
pad2	S 104 Gate	K 0 NoAssign
rim2	S 79 OpnRim	K 0 NoAssign
pad3	t 32 E Tom5	K 0 NoAssign
rim3	t 32 E Tom5	K 0 NoAssign
pad4	t 33 E Tom4	K 0 NoAssign
rim4	t 33 E Tom4	K 0 NoAssign
pad5	t 35 E Tom2	K 0 NoAssign
rim5	t 35 E Tom2	K 0 NoAssign
pad6	C 30 SizzLit	K 0 NoAssign
rim6	C 19 RideLite	K 0 NoAssign
pad7	C 3 C Crash	K 0 NoAssign
rim7	C 1 CrashB	K 0 NoAssign
open	H 18 H OPMu	K 0 NoAssign
rimOpen	H 18 H OPMu	K 0 NoAssign
close	H 5 H ClsMu	K 0 NoAssign
rimClose	H 5 H ClsMu	K 0 NoAssign
footClose	H 34 H PdlMu	K 0 NoAssign
splash	H 48 Hpsplsh1	K 0 NoAssign
pad9	C 32 RidB Lit	K 0 NoAssign
pad10	P 33 CowB1	K 0 NoAssign

No. 45 GM anal.

Input Source	Voice-1 Cat./No./Name	Voice-2 Cat./No./Name
pad1	k 1 AnaQuick	K 0 NoAssign
rim1	K 0 NoAssign	K 0 NoAssign
pad2	s 13 Dance	K 0 NoAssign
rim2	S 79 OpnRim	K 0 NoAssign
pad3	t 10 AnlgTom5	K 0 NoAssign
rim3	t 10 AnlgTom5	K 0 NoAssign
pad4	t 11 AnlgTom4	K 0 NoAssign
rim4	t 11 AnlgTom4	K 0 NoAssign
pad5	t 13 AnlgTom2	K 0 NoAssign
rim5	t 13 AnlgTom2	K 0 NoAssign
pad6	C 30 SizzLit	K 0 NoAssign
rim6	C 19 RideLite	K 0 NoAssign
pad7	C 44 AngCym	K 0 NoAssign
rim7	C 1 CrashB	K 0 NoAssign
open	H 49 H OpnAMu	K 0 NoAssign
rimOpen	H 49 H OpnAMu	K 0 NoAssign
close	H 3 H ClsA1	K 0 NoAssign
rimClose	H 3 H ClsA1	K 0 NoAssign
footClose	H 4 H ClsA2	K 0 NoAssign
splash	H 48 Hpsplsh1	K 0 NoAssign
pad9	C 32 RidB Lit	K 0 NoAssign
pad10	P 35 CowBAn	K 0 NoAssign

No. 46 GM jazz

Input Source	Voice-1 Cat./No./Name	Voice-2 Cat./No./Name
pad1	K 2 2HedMed2	K 0 NoAssign
rim1	K 0 NoAssign	K 0 NoAssign
pad2	S 17 LiteSnr1	K 0 NoAssign
rim2	S 79 OpnRim	K 0 NoAssign
pad3	T 19 Jazz Hi	K 0 NoAssign

rim3	T 19 Jazz Hi	K 0 NoAssign
pad4	T 20 Jazz Mid	K 0 NoAssign
rim4	T 20 Jazz Mid	K 0 NoAssign
pad5	T 22 Jazz Flr	K 0 NoAssign
rim5	T 22 Jazz Flr	K 0 NoAssign
pad6	C 30 SizzLit	K 0 NoAssign
rim6	C 19 RideLite	K 0 NoAssign
pad7	C 3 C Crash	K 0 NoAssign
rim7	C 1 CrashB	K 0 NoAssign
open	H 18 H OPMu	K 0 NoAssign
rimOpen	H 18 H OPMu	K 0 NoAssign
close	H 5 H ClsMu	K 0 NoAssign
rimClose	H 5 H ClsMu	K 0 NoAssign
footClose	H 34 H PdlMu	K 0 NoAssign
splash	H 48 Hpsplsh1	K 0 NoAssign
pad9	C 32 RidB Lit	K 0 NoAssign
pad10	P 33 CowB1	K 0 NoAssign

No. 47 GM brush

Input Source	Voice-1 Cat./No./Name	Voice-2 Cat./No./Name
pad1	K 2 2HedMed2	K 0 NoAssign
rim1	K 0 NoAssign	K 0 NoAssign
pad2	s 113 BrSwH*	K 0 NoAssign
rim2	S 79 OpnRim	K 0 NoAssign
pad3	T 23 BrshJzHi	K 0 NoAssign
rim3	T 23 BrshJzHi	K 0 NoAssign
pad4	T 24 BrshJzMd	K 0 NoAssign
rim4	T 24 BrshJzMd	K 0 NoAssign
pad5	T 26 BrshJzFl	K 0 NoAssign
rim5	T 26 BrshJzFl	K 0 NoAssign
pad6	C 30 SizzLit	K 0 NoAssign
rim6	C 19 RideLite	K 0 NoAssign
pad7	C 3 C Crash	K 0 NoAssign
rim7	C 1 CrashB	K 0 NoAssign
open	H 18 H OPMu	K 0 NoAssign
rimOpen	H 18 H OPMu	K 0 NoAssign
close	H 5 H ClsMu	K 0 NoAssign
rimClose	H 5 H ClsMu	K 0 NoAssign
footClose	H 34 H PdlMu	K 0 NoAssign
splash	H 48 Hpsplsh1	K 0 NoAssign
pad9	C 32 RidB Lit	K 0 NoAssign
pad10	P 33 CowB1	K 0 NoAssign

No. 48 GM class

Input Source	Voice-1 Cat./No./Name	Voice-2 Cat./No./Name
pad1	K 7 BD DRY 4	K 0 NoAssign
rim1	K 0 NoAssign	K 0 NoAssign
pad2	S 85 ParadeS	K 0 NoAssign
rim2	S 79 OpnRim	K 0 NoAssign
pad3	T 15 Lite Hi	K 0 NoAssign
rim3	T 15 Lite Hi	K 0 NoAssign
pad4	T 16 Lite Mid	K 0 NoAssign
rim4	T 16 Lite Mid	K 0 NoAssign
pad5	T 18 Lite Flr	K 0 NoAssign
rim5	T 18 Lite Flr	K 0 NoAssign
pad6	C 48 HCymClsL	K 0 NoAssign
rim6	C 47 HCym2	K 0 NoAssign
pad7	C 50 HCymOpnL	K 0 NoAssign
rim7	C 51 HCymOpnM	K 0 NoAssign
open	H 18 H OPMu	K 0 NoAssign
rimOpen	H 18 H OPMu	K 0 NoAssign
close	H 5 H ClsMu	K 0 NoAssign
rimClose	H 5 H ClsMu	K 0 NoAssign
footClose	H 34 H PdlMu	K 0 NoAssign
splash	H 48 Hpsplsh1	K 0 NoAssign
pad9	C 32 RidB Lit	K 0 NoAssign
pad10	P 33 CowB1	K 0 NoAssign

Preset Song List

● : Kits used with the pad songs

Song		Drum Kit	
No.	Song Name	No.	Kit Name
1	Latiniq	1	Acoustic
2	ZEBULON	24	Zebulon
3	JungleNY	34	JungleNY
4	BigDadd	40	GM std 1
5	Metizo	40	GM std 1
6	Muses	40	GM std 1
7	Vee Bop	10	BeBop
8	FeelNite	41	GM std 2
9	Straight	40	GM std 1
10	Samba 1	40	GM std 1
11	Samba 2	40	GM std 1
12	8beat 1	40	GM std 1
13	8beat 2	40	GM std 1
14	16 beat	40	GM std 1
15	HdRck 1	43	GM rock
16	HdRck 2	43	GM rock
17	HdRck 3	43	GM rock
18	HdRck 4	43	GM rock
19	SlowRock	40	GM std 1
20	Ballad1	40	GM std 1
21	Ballad2	40	GM std 1
22	Ballad3	40	GM std 1
23	Ballad4	46	GM jazz
24	Ballad5	45	GM anal.
25	Ballad6	40	GM std 1
26	Ballad7	45	GM anal.
27	Ballad8	40	GM std 1
28	RckPop1	40	GM std 1
29	RckPop2	46	GM jazz
30	RckPop3	43	GM rock
31	RckPop4	46	GM jazz
32	RckPop5	42	GM room
33	RckPop6	46	GM jazz
34	Dance 1	17	Dance 2
35	Dance 2	45	GM anal.

Song		Drum Kit	
No.	Song Name	No.	Kit Name
36	Dance 3	45	GM anla.
37	Dance 4	44	GM elec.
38	Latin 1	40	GM std 1
39	Latin 2	23	LatinPer
40	Latin 3	23	LatinPer
41	Latin 4	40	GM std 1
42	Latin 5	40	GM std 1
43	Latin 6	40	GM std 1
44	Latin 7	40	GM std 1
45	Latin 8	46	GM jazz
46	Latin 9	40	GM std 1
47	Latin10	46	GM jazz
48	Jazz 1	46	GM jazz
49	Jazz 2	46	GM jazz
50	Jazz 3	40	GM std 1
51	Jazz 4	1	Acoustic
52	Jazz 5	52	GM brush
53	Jazz 6	1	Acoustic
54	Jazz 7	47	GM brush
55	R&B 1	40	GM std 1
56	R&B 2	46	GM jazz
57	R&B 3	42	GM room
58	R&B 4	44	GM elec.
59	R&B 5	46	GM jazz
60	R&B 6	46	GM jazz
61	R&B 7	40	GM std 1
62	R'n'R 1	40	GM std 1
63	R'n'R 2	40	GM std 1
64	Funk 1	40	GM std 1
65	Funk 2	40	GM std 1
66	Funk 3	40	GM std 1
67	Funk 4	40	GM std 1
68	Funk 5	40	GM std 1
69	Reggae1	42	GM room
70	Reggae2	45	GM anal.

Song		Drum Kit	
No.	Song Name	No.	Kit Name
71	World 1	42	GM room
72	World 2	40	GM std 1
73	Shuffle1	40	GM std 1
74	Shuffle2	40	GM std 1
75	Fusion 1	40	GM std 1
76	Fusion 2	40	GM std 1
77	ShamanX	37	MondoKit ●
78	Stepoff	37	MondoKit ●
79	TriTown	37	MondoKit ●
80	Peaceout	37	MondoKit ●
81	Kinetic	36	JumpBack ●
82	Thwak!	36	JumpBack ●
83	Pulsar	36	JumpBack ●
84	Photon	36	JumpBack ●
85	Ganoosh	38	TorqKit ●
86	Babaj	38	TorqKit ●
87	NxtGene.	31	InDaHood
88	PadBass	33	Bs.@Base ●
89	Jko?Naa	33	Bs.@Base ●
90	HornGrv	32	GroovKit ●
91	BsGroov	32	GroovKit ●
92	D&B07	39	Mystery ●
93	Suspens1	39	Mystery ●
94	Suspens2	39	Mystery ●
95	Suspens3	39	Mystery ●

Trigger Setup List

No.	Name	Description
1	Medium	Normal Setting
2	Dynamic	Wide Dynamic Range however, sensitive to vibration.
3	Easy	Averages irregular trigger levels, produces smoother sound
4	HH->BD	A hi-hat controller connected to the trigger input jack "1 KICK" can be used as a kick pedal.
5	DT10/20	Use with DT10/20 drum triggers attached to acoustic drums.
6	LatinSet	Setting for Latin Set
7	Exp Set	Setting for Expansion Set

MIDI Data Format

1. Channel Message

When the [2-2. Channel 10 Program Change/Channel Event Receive] (P. 30) in the utility mode is set to "10=off", the DTXPRESS will not receive channel message for MIDI channel 10.

1.1 Key On Key Off

Sends and receives data.

Receive note range: C-2 to G8

Velocity range: 1 to 127 (note on only)

1.2 Control Change

All control change data for sequencer functions can be received and transmitted. The following lists the tone generator functions and drum trigger functions.

1.2.1 bank select MSB-0

Sends and receives data.

data=0:normal voice

data=127:drum voice

The data will not be processed unless program change data is received.

1.2.2 modulation (No. 1)

Receives only.

1.2.3 foot controller (No. 4)

Sends and receives data.

1.2.3 data entry (No. 6)

Receives only. Used to specify RPN data.

1.2.5 main volume (No. 7)

Sends and receives data.

1.2.6 pan (No. 10)

Sends and receives data.

0 is the far left of a stereo image and 127 is the far right of a stereo image.

1.2.7 expression (No. 11)

Receives only.

1.2.8 hold1 (No. 64)

Receives only.

1.2.9 harmonic content (No. 71)

Receives only.

1.2.10 release time (No. 72)

Receives only.

1.2.11 attack time (No. 73)

Receives only.

1.2.12 brightness (No. 74)

Receives only.

1.2.13 portamento control (No. 84)

Receives only.

1.2.14 effect 1 depth (No. 91)

Receives only. Only effects the reverb send level.

1.2.15 data increment/decrement (No. 100/101)

Receives only.

1.2.16 RPN

00/00 pitch bend sensitivity: Receive only.

00/01 fine tuning: Receive only.

00/02 coarse tuning: Receive only.

7F/7F NULL: Receive only.

1.3 Channel Mode Message

All channel mode messages are received only.

1.3.1 all sound off (No. 120)

Mutes all the sounds currently playing through the specified channel.

1.3.2 reset all controllers (No. 121)

Sets the following controller values back to its initial value:

pitch bend, modulation, expression, hold1, portamento control,

RPN number

1.3.3 all note off (No. 123)

Turns off all the notes of the specified channel currently on.

They will however, not be muted unless "hold 1" is turned off.

1.3.4 omni off (No. 124)

Executes the same process as "all note off".

1.3.5 omni on (No. 125)

Executes the same process as "all note off".

1.3.6 mono (No. 126)

Executes the same process as "all sound off".

1.3.7 poly (No. 127)

Executes the same process as "all sound off".

1.4 Program Change

When the [2-3. Receive Program Change/System Exclusive Messages] (P. 30) in the utility mode is set to "PC=off", the DTXPRESS will not receive program change data.

When the [2-2. Channel 10 Program Change/Channel Event Receive] (P. 30) in the utility mode is set to "10PC=off", the DTXPRESS will not receive MIDI channel 10 program change data.

1.5 Pitch Bend

Sends and receives data.

1.6 Channel Aftertouch

Does not send or receive data.

1.7 Polyphonic Aftertouch

Does not send or receive data.

2. System Exclusive Message

When the [2-3. Receive Program Change/System Exclusive Messages] (P. 30) in the utility mode is set to "SySex=off", the DTXPRESS will not receive system exclusive messages.

The DTXPRESS will not receive system exclusive messages that do not match the device number set in the "DevNo=" of the [2-6. Device Number, Local Control] (P. 31) in the utility mode.

2.1 Parameter Change

2.1.1 GM system ON

F0 7E 7F 09 01 F7

Sets all the data except the MIDI master tuning data to its initial value.
Sends and receives data.

2.1.2 XG system ON

F0 43 1n 4C 00 00 7E 00 F7

"n" stands for device number.
Executes the same process as GM system ON.
Receives only.

2.1.3 identify request

F0 7E 0n 06 01 F7

"n" stands for device number.
After receiving, the identify reply is transmitted.
Receives only.

2.1.4 MIDI master volume

F0 7F 7F 04 01 XX mm F7

Ignores "XX". "mm" is the volume.
Receives only.

2.1.5 MIDI master tune

F0 43 1n 27 30 00 00 mm ll cc F7

"n" stands for device number.
The values of "mm(MSnibble)" and "ll(LSnibble)"—128 is used for 1 cent unit when tuning.
Receives only.

2.2 Bulk Dump

Sends and receives data. All the data except the system data is converted into 1 or 2 byte ASCII characters and transmitted.

• DTXPRESS bulk dump common message.

F0 43 7D Xn ss ss 44 54 58 4C("DTXL") tt tt tt ii ii jj jj dataBytes csum F7

tt tt tt tt This displays the ID of the bulk type. 4 characters of ASCII code.

ss ss data bytes (from model ID to data) MS7bit, LS7bit

ii ii data packet index number MS7bit, LS7bit
If the data size exceeds 4096, the total is divided into F0-F7 packets, the packet index number will start at 00 01 (0001) increasing by 1 for each successive packet. The last packet is 7F 7F (3FFF).
When the data size is less than 4096, it will be 00 00 (0000).

jj jj object number MS7bit, LS7bit
Object number. In the DTXPRESS system only 1 article exists, that will become 7F 7F (3FFF).

csum indicates the 7bit of the 2's complement of the sum of the data from the model ID (ss ss) to data Bytes.

2.2.1 system

F0 43 7D 0n ss ss 44 54 58 4C("DTXL") 53 59 53 54("SYST") 00 00 7F 7F data csum F7

2.2.2 map

F0 43 7D 0n ss ss 44 54 58 4C("DTXL") 55 4D 41 50("UMAP") 00 00 7F 7F data csum F7

2.2.3 drumkit

F0 43 7D 0n ss ss 44 54 58 4C("DTXL") 44 4B 49 54("DKIT") 00 00 jj jj data csum F7

jj jj Indicated by MS7bit, LS7bit. This number derived from the user drum kit number by counting from "0". In the case of the edit buffer, it is 7F 7F (3FFF).

2.2.4 trigger

F0 43 7D 0n ss ss 44 54 58 4C("DTXL") 54 52 49 47("TRIG") 00 00 jj jj data csum F7

jj jj The user trigger's number MS7bit, LS7bit.
7F 7F specifies the edit buffer

2.2.5 song

F0 43 7D 0n ss ss 44 54 58 4C("DTXL") 53 4F 4E 47("SONG") ii ii jj jj data2 csum F7

jj jj The user song number's MS7bit, LS7bit.
7F 7F specifies the current song.

data 2 Divides the original data into the 4 bits MSnibble, LSnibble, and converts 1 byte data to 2 bytes.

2.3 Dump Request

Receives only.

Transmits the corresponding bulk dump.

F0 43 7D 2n 44 54 58 4C("DTXL") tt tt tt tt jj jj F7

jj jj object number MS7bit, LS7bit
Object number. In the DTXPRESS system only 1 article exists, that will become 7F 7F (3FFF).
The object number contains the number that specifies the drum kit number, etc.
Only one article exists, system data or edit buffer data, etc., that appoints 7F 7F (3FFF).
However, 7F 7F does not correspond in the case of song data.

3. System common message

3.1 Select a song

f3 nn

"nn" stands for song number.

Receives only.

4. Realtime message

Sends and receives data.

4.1 timing clock

Synchronizes with the timing clock received when the Sync mode in the utility mode's [3-6. Sync Mode] (P. 33) is set to "ext" or "auto".

4.2 start, continue, stop

When the [3-4. MIDI Control] (P. 33) in the utility mode is set to "MIDI Control=off", the DTXPRESS will not receive start, continue and stop.

4.3 active sensing

Once active sensing data has been received, if no MIDI data is subsequently received for longer than an interval of approximately 300 msec, the DTXPRESS will mute all the sounds.

Send the messages within an interval of approximately 300 msec.

Function ...	Transmitted	Recognized	Remarks
Basic Default Channel Changed	1 - 16 1 - 16	1 - 16 1 - 16	memorized
Mode Default Messages Altered	x x *****	3 3 x	
Note Number : True voice	0 - 127 0 - 127	0 - 127 0 - 127	
Velocity Note ON Note OFF	o 9nH,v=1-127 x 9nH,v=0	o v=1-127 x	
After Key's Touch Ch's	x x	x x	
Pitch Bender	x	o	7 bit resolution
Control Change 0,4,7,10,32 1,6,11,64 71,72,73 74,84,91 100,101	o x x x x	o o o o o	
Prog Change : True #	o 0 - 127 *****	o 0 - 127	
System Exclusive	o	o	
System : Song Pos. : Song Sel. Common : Tune	x x x	x o x	
System :Clock Real Time :Commands	o o	o o	
Aux :All Sound Off :Reset All Cntrls :Local ON/OFF :All Notes OFF Mes- :Active Sense sages:Reset	x x o x o x	o o o o(123-127) o x	

DRUMKIT BLANK CHART

Drumkit Name _____																				
Rev Type				Rev Time				Rev Master Return				Volume								
Category	Voice No.	Volume	Pan	Tune C	Tune F	Layer Balance	Decay	Filter	Note No.	Channel	Gate Time	X Fade	Rev Send							
Alt Group	Key Assign	Hold Mode	Keyoff	Function	Song No.	Song Repeat	Song Mode	Rim to Pad												
pad1																				
rim1																				
pad2																				
rim2																				
pad3																				
rim3																				
pad4																				
rim4																				
pad5																				
rim5																				
pad6																				
rim6																				
pad7																				
rim7																				
open																				
rimOpen																				
close																				
rimClose																				
footClose																				
splash																				
pad9																				
pad10																				

TRIGGER SETUP BLANK CHART

Channel	sw	pc	msb	lsb	vol	pan
1						
2						
3						
4						
5						
6						
7						
8						
9						
10						
11						
12						
13						
14						
15						
16						

Setup Name _____

Type	Gain	Min Vel	VelCurve	SelfRej	Rejection	Spec.Rej In	SPEC.Rej Level
IN 1							
IN 2							
IN 3							
IN 4							
IN 5							
IN 6							
IN 7							
IN 8							
IN 9							
IN 10							

