

# YAMAHA

MUSIC SYNTHESIZER

# SY77

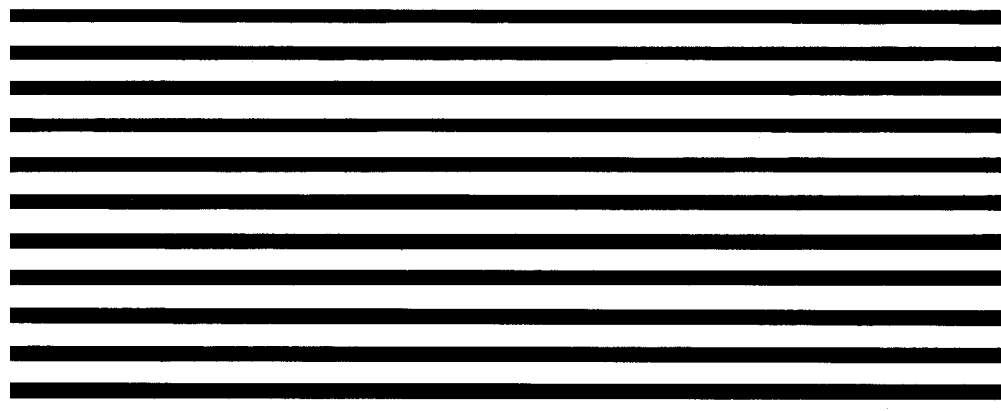

**OPERATING MANUAL**

# SUPPLEMENTAL MARKING INFORMATION

Yamaha Digital Musical Instrument Products will have either a label similar to the graphic shown below or a molded/stamped facsimile of the graphic on its enclosure. The explanation of these graphics appears on this page. Please observe all cautions indicated.

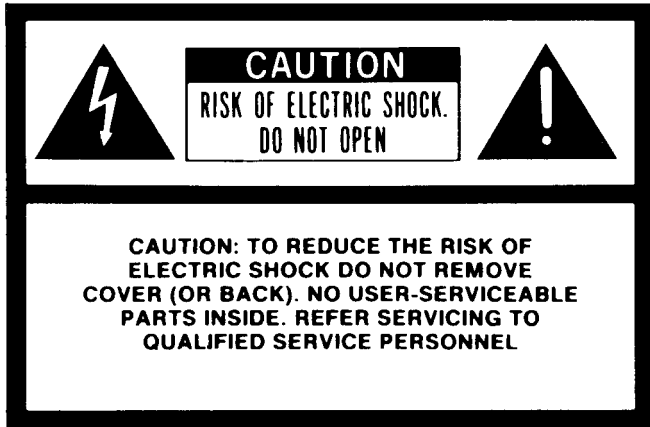

The exclamation point within an equilateral triangle is intended to alert the user to the presence of important operating and maintenance (servicing) instructions in the literature accompanying the product.



The lightning flash with arrowhead symbol, within an equilateral triangle, is intended to alert the user to the presence of uninsulated "dangerous voltage" within the product's enclosure that may be of sufficient magnitude to constitute a risk of electric shock to persons.

\* This applies only to products distributed by YAMAHA CORPORATION OF AMERICA.

Litiumbatteri!  
Bör endast bytas av servicepersonal.  
Explosionsfara vid felaktig hantering.

VAROITUS!  
Lithiumparisto, Räjähdyssäädä.  
Pariston saa vaihtaa ainoastaan älään  
ammattimies.

ADVARSEL!  
Lithiumbatteri!  
Eksplosionsfare. Udskiftning må kun foretages  
af en sagkyndig, - og som beskrevet i  
servicemanualen.

Dette apparat overholder det gældende EF-direktiv  
vedrørende radiostøj.

Cet appareil est conforme aux prescriptions de la direc-  
tive communautaire 87/308/CEE.

Diese Geräte entsprechen der EG-Richtlinie  
82/499/EWG und/oder 87/308/EWG.

This product complies with the radio frequency  
interference requirements of the Council Directive  
82/499/EEC and/or 87/308/EEC.

Questo apparecchio è conforme al D.M.13 aprile 1989  
(Direttiva CEE/87/308) sulla soppressione dei radio-  
disturbi.

Este producto está de acuerdo con los requisitos sobre  
interferencias de radio frecuencia fijados por el Consejo  
Directivo 87/308/CEE.

**YAMAHA CORPORATION**

## IMPORTANT NOTICE FOR THE UNITED KINGDOM

### Connecting the Plug and Cord

**IMPORTANT:** The wires in this mains lead are coloured  
in accordance with the following code:

BLUE : NEUTRAL  
BROWN : LIVE

As the colours of the wires in the mains lead of this  
apparatus may not correspond with the coloured markings  
identifying the terminals in your plug proceed as follows:

The wire which is coloured BLUE must be connected to the  
terminal which is marked with the letter N or coloured  
BLACK.

The wire which is coloured BROWN must be connected to  
the terminal which is marked with the letter L or coloured  
RED.

Making sure that neither core is connected to the earth  
terminal of the three pin plug.

\* This applies only to products distributed by YAMAHA -  
KEMBLE MUSIC (U.K.) LTD.

## CANADA

THIS DIGITAL APPARATUS DOES NOT EXCEED THE "CLASS B"  
LIMITS FOR RADIO NOISE EMISSIONS FROM DIGITAL APPARATUS  
SET OUT IN THE RADIO INTERFERENCE REGULATION OF THE  
CANADIAN DEPARTMENT OF COMMUNICATIONS.

LE PRESENT APPAREIL NUMERIQUE N'EMET PAS DE BRUITS  
RADIOELECTRIQUES DEPASSANT LES LIMITES APPLICABLES  
AUX APPAREILS NUMERIQUES DE LA "CLASSE B" PRESCRITES  
DANS LE REGLEMENT SUR LE BROUILLAGE RADIOELECTRIQUE  
EDICTE PAR LE MINISTERE DES COMMUNICATIONS DU CANADA.

\* This applies only to products distributed by YAMAHA  
CANADA MUSIC LTD.

\* Keyboard \*

### SEQUENCER

The sequencer is always in either Song or Pattern mode.

③ Song mode (16 tracks)

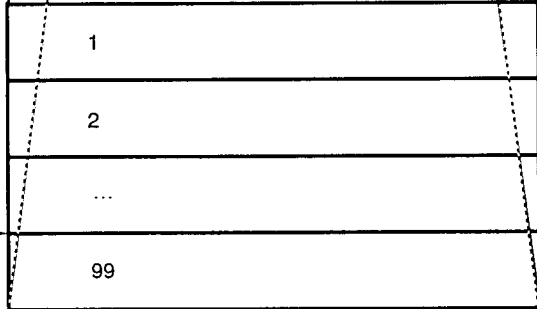
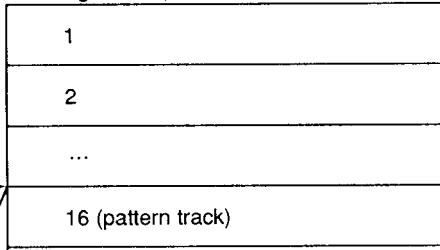

④ Pattern mode (99 patterns)

### TONE GENERATOR

The tone generator is always in either Multi or Voice mode.

② Multi mode (16 voices)

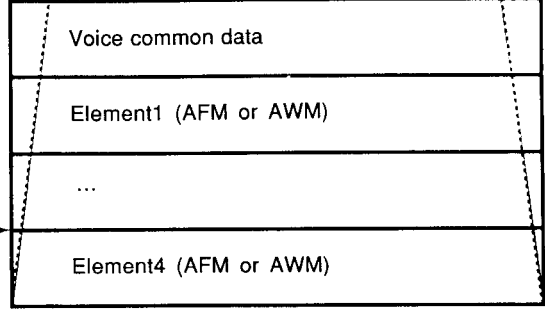
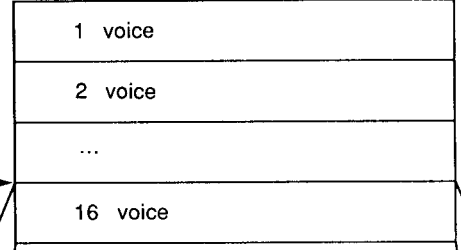

① Voice mode (1,2 or 4 elements)

## INTRODUCTORY SECTION

- ①—④ INTRODUCING THE SY77
- ③ ④ HOW TO USE THE SEQUENCER
- ① HOW TO EDIT A VOICE

## REFERENCE SECTION

- ① VOICE PLAY MODE
- ① VOICE EDIT MODE
- ② MULTI PLAY MODE
- ② MULTI EDIT MODE
- ③ SONG MODE
- ④ PATTERN MODE
- UTILITY MODE

## APPENDIX

Thank you for purchasing the Yamaha SY77 digital synthesizer. The SY77 is the first of a new generation of Yamaha synthesizers featuring the new Realtime Convolution and Modulation (RCM) hybrid tone generation system, which uses Advanced FM (AFM) tone generation and Advanced Wave Memory (AWM) tone generation in conjunction with realtime digital filtering.

The SY77 can function as up to 16 independent synthesizers with dynamically allocated voices, and includes an on-board 16-track 99-pattern sequencer.

To take full advantage of the SY77 and enjoy long and trouble-free use, please read this manual carefully.

## How to use this manual

This manual is divided into three sections; an introductory section, a reference section, and an appendix.

**Introductory section:** This section contains the information you need to start using your SY77 right away.

- **Introducing the SY77:** Please be sure to read this section. It will tell you how to play the sounds, about the main features of the SY77, and about basic operation.
- **How to use the sequencer:** This explains how to use the built-in sequencer to record your own song of up to 16 parts, with the SY77 functioning as up to sixteen independent instruments.
- **How to edit a Voice:** Read this when you want to modify a voice or create a completely new voice.

**Reference section:** This section contains a full explanation of all the SY77's functions. Once you have worked through the introductory section and are comfortable with basic operation, glance through this section to get an idea of the SY77's capabilities. Refer to the details when necessary.

**Appendix:** This section contains technical information that may be of interest to advanced users or programmers.

## Conventions in this manual

In order to present information as clearly as possible, the following conventions are used in this manual.

- The names of front panel buttons and controls are set in small capital type; e.g., press the EDIT button.
- Italics are used mainly when referring to a section in this manual; e.g., for details refer to *AFM element job 5. AFM sensitivity*.
- Most of the LCDs in the SY77 have a unique Page Jump number to which you can jump by pressing JUMP and entering the number. These numbers will be prefixed by a “#” sign; e.g., JUMP #312.
- Function names will be capitalized when they first occur or when necessary for emphasis, but will be uncapitalized in subsequent occurrences; e.g., adjust the LFO Speed ... after adjusting the LFO speed, ...
- The beginning of each two-page subsection in the introductory section contains a short abstract or summary of the entire subsection, printed in bold type.
- Three periods between two numbers are used to indicate that a parameter can be set to any value in this range; e.g., Velocity Sensitivity (-7...+7). Since some parameters can be set to negative values, this avoids the possibility of confusing a dash with a minus sign.

# PRECAUTIONS

---

## Data backup

It is possible for data in internal memory to be lost as a result of inappropriate operation or other reasons. We recommend that you keep backups of important voice data on a memory card (MCD64). It is also possible for the data in a memory card to be lost as a result of static electricity, magnetic fields, or other causes. For very important data it is always a good idea to make double backups.

## Multi Play mode

If many multi-element voices are played simultaneously when in Multi Play mode, note timing may sometimes be slightly delayed. In such cases, select voices that use fewer elements, or reduce the number of notes.

## Backup battery

The SY77 contains a backup battery which preserves settings such as for voice and multi data when the power is turned off. The life of this battery is approximately 5 years. However depending on the date of purchase, battery life may be shorter than this.

If the backup battery runs low, a message "Change internal Battery!" will appear in the display when the power is turned on. If the backup battery runs down completely, the voice and multi data will be lost, so when this display appears, immediately store your data to a memory card and contact the dealer where you purchased the SY77 or your nearby Yamaha service station to have the battery replaced. When the battery is replaced, the internal voice and multi data will be lost, so be sure to save the data to a memory card first.

## Third-party Software

Yamaha can not take any responsibility for software produced for this product by third-party manufacturers. Please direct any questions or comments about such software to the manufacturer or their agents.

# CONTENTS

## INTRODUCTORY SECTION

---

<b>INTRODUCING THE SY77</b> .....	<b>3</b>	Place the patterns in the pattern track.....	40
How to setup and play .....	4	Realtime recording.....	42
How to load and play the disk demo songs .....	6	Punch-in recording .....	44
How to record a song.....	8	Song editing .....	46
About the SY77: RCM hybrid synthesis .....	10	Using a song edit job.....	48
About the SY77: AFM and AWM voices .....	12	Saving your sequence to disk.....	50
About the SY77: filter, pan, and effects .....	14		
About the SY77: multi-timbral sequencing .....	16	<b>HOW TO EDIT A VOICE</b> .....	<b>53</b>
Front panel: left side.....	18	What is a voice.....	54
Front panel: right side .....	20	What is an AWM element.....	58
Rear panel .....	22	The basics of FM synthesis .....	58
How to move around: job directories.....	24	What is an AFM element.....	60
How to move around: the jump function.....	26	The process of voice editing .....	62
How to enter data.....	28	How voice edit mode is organized.....	64
How to use the numeric key pad .....	30	Simple editing: reverb (Effect) .....	66
		Simple editing: tone (Filter) .....	68
<b>HOW TO USE THE SEQUENCER</b> .....	<b>33</b>	Simple editing: vibrato (LFO) .....	70
How the sequencer controls the tone		Simple editing: using a controller .....	72
generator.....	34	Simple editing: attack (EG).....	74
Set up a multi.....	36	How to name and store your new voice.....	76
Create rhythm patterns.....	38	How to edit a drum voice .....	78

## REFERENCE SECTION

---

<b>VOICE PLAY MODE</b> .....	<b>83</b>	2. Element detune.....	93
Voice select .....	84	3. Note shift .....	93
Voice directory .....	84	4. Note limit .....	94
Copy voice.....	85	5. Velocity limit.....	95
Controller view .....	85	6. Element dynamic pan .....	95
Send program change .....	86	6.0 Dynamic pan edit.....	96
		6.0.1 Copy pan data.....	97
<b>VOICE EDIT MODE</b> .....	<b>87</b>	6.1 Pan source .....	97
Compare.....	89	6.2 Pan EG.....	98
Store voice .....	89	6.3 Pan name.....	99
Element on/off.....	90	7. Output group select .....	99
Element select .....	90	8. Random pitch.....	99
Voice mode select.....	91	9. Portamento.....	100
Common data.....	92	10. Effect set .....	100
Common data job directory .....	92	10.1 Effect mode select.....	101
1. Element level .....	92	10.1.1 Copy voice effect .....	102

10.2 (F1) Modulation effect 1 set (Data)....	102	5. AWM LFO .....	144
10.2 (F2) Modulation effect 1 set (Parameters).....	103	6. (F1) AWM pitch EG (Data).....	145
10.4 (F1) Reverb effect 1 set (Data) .....	103	6. (F2) AWM pitch EG (EG settings).....	145
10.4 (F2) Reverb effect 1 set (Parameters).....	104	7. AWM filter.....	146
11. Micro tuning .....	106	15. Initialize AWM element.....	147
11.0 Micro tuning edit.....	108	16. Recall voice .....	148
11.0.1 Copy micro tuning .....	108	Drum set data .....	149
11.1 Micro tuning data.....	109	Drum set job directory .....	149
11.2 Micro tuning name.....	109	1. Voice volume.....	149
12. (F1) Controller set (Pitch bend) .....	110	2. Wave data set .....	150
12. (F2) Controller set (Modulation).....	110	3. Effect set.....	151
12. (F3) Controller set (Pan) .....	111	4. Controller set.....	151
12. (F4) Controller set (Other) .....	112	5. Voice name .....	152
13. Voice name.....	113	7. Initialize voice.....	152
15. Initialize voice.....	113	8. Recall voice.....	153
16. Recall voice.....	115	<b>MULTI PLAY MODE .....</b>	<b>155</b>
AFM element data.....	116	Multi select.....	157
AFM element job directory.....	116	Multi directory .....	157
Operator on/off .....	117	Copy multi.....	158
AFM algorithm.....	117	Send program change.....	158
Copy element.....	117	<b>MULTI EDIT MODE .....</b>	<b>159</b>
Copy operator .....	118	Compare.....	161
1. (F1) AFM algorithm (Form).....	118	Store multi.....	161
1. (F2) AFM algorithm (External input)....	120	Multi edit job directory.....	161
1. (F3) AFM algorithm (Input level) .....	120	1. Voice select .....	162
2. AFM oscillator.....	121	2. Voice volume.....	163
3. (F1) AFM operator EG (Each operator) .....	123	3. Voice tuning .....	163
3. (F2) AFM operator EG (All operators) .....	125	4. Voice note shift.....	164
4. (F1) Operator output (Each).....	125	5. Voice static pan.....	164
4. (F2) AFM operator output (All).....	126	6. Voice output group select .....	165
5. AFM sensitivity .....	127	7. Effect set.....	165
6. (F1) AFM LFO (Main).....	127	8. Multi name.....	166
6. (F2) AFM LFO (Sub).....	128	15. Initialize multi .....	166
7. (F1) AFM pitch EG (Switch) .....	129	16. Recall Multi .....	167
7. (F2) AFM pitch EG (EG settings) .....	130	<b>SONG MODE .....</b>	<b>169</b>
8. AFM filter .....	131	How song play mode and song edit mode are organized .....	171
8.0 Copy filter.....	131	Song play.....	172
8.1 Cutoff frequency .....	131	Song record .....	174
8.2 Cutoff scaling .....	133	Realtime recording.....	175
8.3 Cutoff EG .....	134	Punch-in recording .....	176
15. Initialize AFM element .....	135	Step recording.....	177
16. Recall voice.....	137	Song edit .....	179
AWM element data.....	138	Song edit (graph) .....	179
AWM element job directory .....	138	Song edit (data change).....	180
Copy element.....	138	Song edit (data insert).....	181
1. AWM waveform set.....	139	Chain pattern .....	182
2. AWM EG.....	141	Song edit jobs .....	185
3. AWM output.....	142	1. Quantize.....	186
4. AWM sensitivity.....	143	2. Modify gate time.....	186

3. Modify velocity.....	187	1. Copy pattern .....	210
4. Crescendo.....	188	2. Get pattern.....	211
5. Transpose.....	189	3. Put pattern.....	211
6. Thin out .....	189	4. Put chain pattern.....	212
7. Erase event .....	190	Pattern setup jobs .....	213
8. Note shift.....	190	Clear pattern.....	214
9. Move clock .....	191	<b>UTILITY MODE.....</b>	<b>215</b>
10. Copy measure.....	191	System utility.....	217
11. Erase measure .....	192	1. Master tuning .....	217
12. Delete measure.....	193	2. Velocity set.....	217
13. Create measure.....	193	3. Controllers.....	219
14. Mix track.....	194	4. Edit confirm.....	220
15. Erase track.....	194	5. Greeting message.....	220
16. Clear song .....	195	MIDI utility.....	221
Song setup jobs.....	196	1. Channel set.....	221
1. Receive event.....	196	2. Program change.....	222
2. Output channel.....	197	3. Bulk dump .....	223
3. MIDI control.....	197	Card utility .....	224
4. Accent level.....	197	1. Save to card .....	225
5. Clock/Beat.....	198	2. Load from card .....	226
Song name.....	199	3. Format card.....	226
<b>PATTERN MODE .....</b>	<b>201</b>	Disk utility .....	227
How pattern play mode and pattern edit mode are organized.....	203	1. Save to disk .....	227
Pattern play .....	204	1.1 Save To Disk filename .....	228
Pattern record .....	205	2. Load from disk .....	229
Pattern realtime record.....	206	3. Format disk .....	230
Pattern step record.....	207	4. Backup disk.....	231
Pattern edit .....	209	5. Rename file .....	231
Pattern edit jobs.....	210	6. Delete file.....	232
		7. Disk status .....	232

## APPENDIX

Explanation of the preset voices .....	238	Wave card.....	244
Preset 1.....	238	Disk.....	245
Preset 2.....	239	Sequencer and display .....	245
Using RCM hybrid synthesis.....	242	Battery .....	245
Suggestions for using AWM + AFM (Voice modes 9 & 10) .....	242	Other .....	246
Error messages.....	244	Multi data blank chart .....	247
MIDI.....	244	Specifications.....	248
Data card.....	244	Index .....	249



# INTRODUCTORY SECTION



# INTRODUCING THE SY77

This section will tell you how to play the sounds, introduce you to the main features of the SY77, and explain basic operation.

<b>Contents of this section</b>	<b>page</b>
<b>How to setup and play .....</b>	<b>4</b>
<b>How to load and play the disk demo songs .....</b>	<b>6</b>
<b>How to record a song.....</b>	<b>8</b>
<b>About the SY77: RCM hybrid synthesis .....</b>	<b>10</b>
<b>About the SY77: AFM and AWM voices.....</b>	<b>12</b>
<b>About the SY77: filter, pan, and effects.....</b>	<b>14</b>
<b>About the SY77: multi-timbral sequencing .....</b>	<b>16</b>
<b>Front panel: left side.....</b>	<b>18</b>
<b>Front panel: right side.....</b>	<b>20</b>
<b>Rear panel.....</b>	<b>22</b>
<b>How to move around: job directories .....</b>	<b>24</b>
<b>How to move around: the jump function.....</b>	<b>26</b>
<b>How to enter data .....</b>	<b>28</b>
<b>How to use the numeric key pad.....</b>	<b>30</b>

# How to setup and play

The first thing you will probably want to do is play the voices (sounds) of your new SY77. Here's how to select and play the SY77's voices.

## Connections

Make sure that your amp/speaker system and the SY77 are switched off. Connect the rear panel output OUTPUT 1/1+2 jacks (L/MONO and R) to the inputs of your amp/speaker system. Or, if you are using a set of stereo headphones, plug them into the rear panel PHONES jack.

## Turn the power on

Turn down the SY77's two VOLUME sliders marked OUTPUT 1 and 2, located at the far left. Then turn the power on by pressing the POWER switch located on the rear panel to your right. After displaying a greeting message for about two seconds, a display similar to the following should appear. If the SY77 was in Voice Play mode when the power was last turned off, the upper left of the LCD will read "VOICE".



If the upper line of the display does not show VOICE then press the VOICE button located at the upper left of the front panel.

Make sure that the volume of your amp/speaker system is turned down, and turn its power on. Set the volume of your amp/speaker system to an appropriate level, and gradually raise the SY77's OUTPUT 1 and 2 sliders while playing the keyboard. If you don't hear anything, re-check the connections, and make sure that your amp/speaker system is functioning correctly.

## How to select and play voices

What you hear when you play the keyboard is defined as a Voice. The SY77 has 128 voices that are preset in permanent memory, and 64 memories for you to store your own newly created voices. An optional RAM or ROM card can be inserted into the VOICE card slot to provide 64 more voices.

The preset voices are organized into two locations; PRESET 1 and PRESET 2. Each of these has four banks (A–D) with 16 voices in each. The LCD shows the ten-character voice name, and also tells you which memory the voice is from. The number in parentheses indicates what number the voice would be if we started counting from the beginning of the bank.

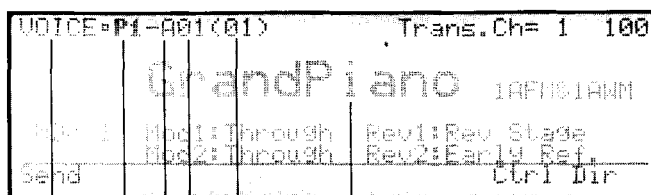

- ① This indicates that you are in Voice Play mode.
- ② Memory PRESET 1.
- ③ Bank A.
- ④ Voice number "1" of bank A.

- 5 If we count from the beginning of the bank, this is Voice number 1.
- 6 The voice name is “GrandPiano”.

You will learn about the other parts of the display later. For now, here’s how to select voices.

1. Select the voice memory; INTERNAL, CARD (only if a card is inserted into the DATA slot), PRESET 1, or PRESET 2. The selected LED will light.
2. Select a bank A, B, C, or D. The selected LED will light.
3. Select a voice 1–16. The selected LED will light, and the LCD display will show the newly selected voice name.

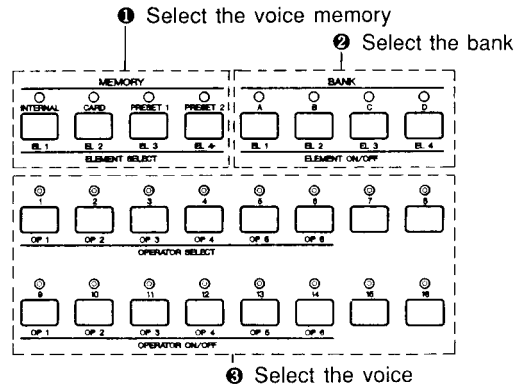

Notice that the voice does not actually change until you specify the number 1–16. If you want to play a different voice in the same bank, simply specify a different number 1–16. There’s no need to re-select the voice memory and the bank each time.

Go ahead and try out each of the preset voices. When you are ready to learn more about the SY77, continue reading.

PRESET 1 (64 voices)

#	Bank A	Bank B	Bank C	Bank D
1	GrandPiano	Dyna Grand	Mute Trmpt	Tutti Orch
2	Ariane	MW2Grand	FlugelHorn	Trad E.Pno
3	Dyno E.Pno	8ba Piano	Big Band	Full E.Pno
4	Alto Sax	Rock Pno	Brass1 Sct	Bop Organ
5	BrasChoral	Chorus Pno	1980 Brass	Warm Organ
6	Folk 1 Gtr	BigChordEP	Star Brass	Deep Organ
7	Triton	Ice Piano	Anna Brass	Pan Flute
8	FrenchHorn	Dark E.Pno	BrashBrass	MW2Feedbck
9	MW2TackPno	Wet Clavi	Soft Brass	Distort5th
10	Wood Bass	TightClavi	DigiSwpBrs	Thumb Bass
11	ChamberStr	Celesta	Brass2 Sct	Sync Bass
12	Jazz Organ	Harpsichrd	Soft Sax	FullString
13	Nasty Saw	Full Organ	Tenor Sax	WideString
14	Metamomics	Pipe Organ	Flute	ConvoStrgs
15	Itopia	Solo Trmpt	Clarinet	Oh Choir
16	Wild Sing	DualTrmpt	Reed Piper	Orchestra

PRESET 2 (64 voices)

#	Bank A	Bank B	Bank C	Bank D
1	SaxSection	Violin	Shamisen	Brass Orch
2	Folk 2 Gtr	Pizzicato	Koto	Millenium!
3	Humbucker	Contrabass	Sitar	Catharsis
4	SingleCoil	Air Cello	Steel Drum	MethylMist
5	12stGuitar	SilkString	Harp	Voyager
6	Guit Guitar	Obie Strgs	Accordion	Inferno
7	Mute E.Gtr	SizleStrgs	Harmonica	Valkyrie
8	JazzGuitar	Ah Choir	Harpomatic	Syren Song
9	Pick Bass	Spirits	Ravi Clavi	Anna Sweep
10	Fretless B	Chor Meist	Forest	SyncanSyn
11	FingerBass	Vibes	Satin Bell	AnnaPad
12	Syn Bass	Marimba	Mr.Lucky	Gosh!
13	Plastic Bs	Pluck Echo	Mini Lead!	Debonair
14	Mini Bass	Bah Mallet	Keytar	HiddenRing
15	Boppa Bass	Oz Hammer	SoloFlight	Drum 1
16	BreathBass	Ice Chime	Wayfarer	Drum 2

# How to load and play the disk demo songs

The disk included with the SY77 contains demo songs which take advantage of its capabilities. Here's how to load and play the songs.

## Load the demo song data from disk

1. Press UTILITY, and then press F4 (Disk) to get the following display. (If you have been editing voice or multi data, the top line of the LCD will blink "AUTO-STORE". For details on Auto-Store, refer to page 63.)

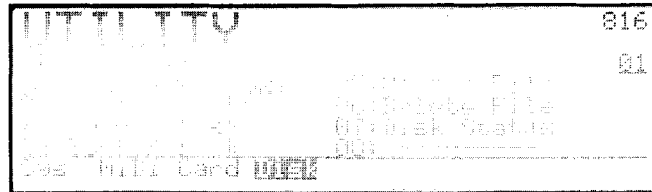

2. Insert the demo disk into the disk drive, with the metal shutter going in first and the label facing up. Push it gently in until it clicks into position.
3. Press  $\nabla$  once to move the cursor to 02:Load From Disk, and press ENTER to get the following display.

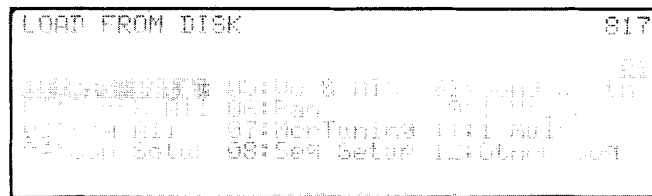

4. With the cursor located at 01:All Data, press ENTER to get a display like the following. (The filenames will be different.)

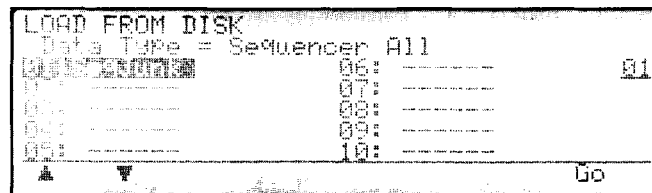

5. Move the cursor to select the song you wish to hear, and press F8 (Go). The display will ask "Are you sure". Press YES if you are sure you want to load the song data from disk. Loading song data from disk will erase any song data which was previously in the SY77 sequencer memory.
6. While the data is being read from disk, the bottom line of the LCD will show "Now executing", and "Completed!" when the data has been completely read.

## Enter song play mode and playback the song

7. Press SONG to make the SONG LED light red. A display like the following will appear. (The song name and other details will depend on the song you have selected.)

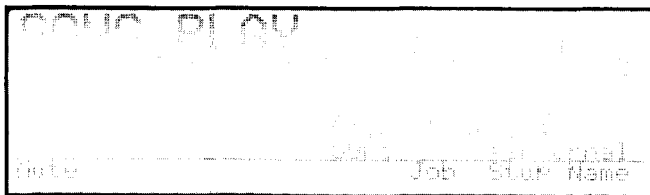

8. Press RUN and the playback will begin. When the song ends you automatically return to measure 1.
9. To stop playback during the song press STOP. To resume playback from where you stopped, press START. Or, use << and >> to move to another measure before pressing START. To return to the beginning of the song press |<.

## How to load another song

To load another song from disk, repeat the procedure from step 1. Or, press JUMP, 8, 1, 7 and then ENTER to jump directly to step 3.

## How to load other demo disks

The demo disk included with the SY77 contains both synthesizer and sequencer data, and must be loaded by selecting 01:All Data in step 4. If you have other demo disks, refer to the package to see what type of data the disk contains, and select the appropriate type in step 4.

### CAUTION

If the internal memory contains data you wish to keep, be sure to save it before loading the demo.

# How to record a song

The SY77 can function as 16 independent synthesizers, and also contains a built-in 16 track sequencer. This allows you to create sixteen-part compositions without using any other equipment. This section will explain the simplest way to record a multi-part song.

## Clear the sequencer memory

1. Turn the SY77 power off, and all data in the sequencer memory will be cleared.

## Select a Multi

In multi mode the SY77 can function as 16 independent synthesizers. The multi settings determine which voices are used.

2. Press MULTI to enter multi mode. The MULTI LED will light red and a display similar to the following will appear.

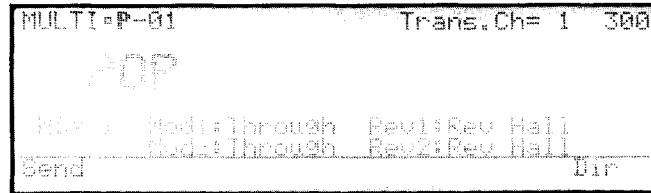

3. Press PRESET 1, then press a memory select button 1–16 to select one of the following 16 preset Multis.

Number	Multi Name	Voice Number															
		01	02	03	04	05	06	07	08								
		09	10	11	12	13	14	15	16								
01	POP	P2-A09	P1-A12	P1-B15	P1-A04												P2-D15
02	ROCK 1	P2-A09	P1-A12	P1-A08													P2-D16
03	JAZZ 1	P1-A10	P1-A01	P1-A04	P1-C04												P2-D15
04	JAZZ 2	P1-A10	P1-A09	P1-C13	P2-C13												P2-D15
05	BAROQUE	P2-B01	P2-B03	P1-B12	P1-C14												
06	ROCK 2	P2-A12	P1-C05	P2-C11													P2-D16
07	ORCHESTRA	P1-A11	P2-B03	P1-C07	P1-C15	P1-C16	P1-B15	P1-A08									
08	FOLK	P1-A06	P1-A10	P2-B01	P2-C07												P2-D15
09	JAZZ 3	P1-A10	P2-B11	P2-A03	P1-C15												P2-D15
10	CHURCH	P1-B14	P2-B08	P1-A15	P1-B07												
11	FUNK	P1-D10	P2-C14	P2-A07	P1-C03												P2-D16
12	FLEXIBLE ONE	P2-A09	P1-C03	P1-A03	P2-B05												P2-D16
13	OLD SYNTHESIZERS	P2-A13	P2-C12	P1-D14	P1-C09												P2-D16
14	PIANO & STRINGS	P1-A01	P1-D12														
15	ENVIRONMENT	P2-D04	P2-D06	P2-B15													P2-D15
16	MOTIF	P1-A01															P2-D16

P1: Preset 1 P2: Preset 2

The selected multi will be displayed in large characters.



## Prepare for recording

4. Press SONG. The SONG LED will light red and the following display will appear.

```
SONG PLAY [ 1 ]
Measure=128 Time= 4/4 J=120 Used= 49%
Quantize =off Click =off
Receive Ch=kbd Click Beat=1/4
Sync =internal
STEP Pnch Over RPlc Job Step Name
```

5. Press RECORD to get the following display.

```
SONG RECORD [ 1 ]
Measure=128 Time= 4/4 J=120 Used= 49%
Quantize =off Click =rec
Receive Ch=kbd Click Beat=1/4
Sync =internal
STEP Pnch Over RPlc Job Step Name
```

## Record the first track

6. Press a track select button to select the track you wish to record. With the default settings, the tracks of the sequencer will transmit on the channel of the corresponding number, and will be played by the corresponding channel of the multi you have selected. For example if you have selected Multi 1. POP and wish to record the Pick Bass part, press 1. If you select a channel for which the multi does not use a voice, there will be no sound.
7. Press PLAY. After a two-measure countdown, recording will begin. Play along with the metronome to record the part. When you are finished, press STOP. Press  $\leftarrow$  to return to measure 1.

## Record additional tracks

8. As desired, repeat steps 6 and 7 to select and record additional tracks.

### Note:

*A more complete explanation of using the SY77 sequencer is given in the following section How to use the sequencer, which explains how to set up your own Multi, create rhythm patterns, arrange the rhythm patterns in track 16 (the pattern track), record additional tracks, edit the song, and save the finished song to disk. Refer to page 33.*

# About the SY77: RCM hybrid synthesis

The SY77's RCM hybrid tone generation system fuses the realism of digital samples with the expressive power of FM. It uses Advanced Wave Memory 2 (AWM2) and Advanced Frequency Modulation (AFM) in conjunction with digital filters to allow a wide variety of sound creation techniques.

System diagram

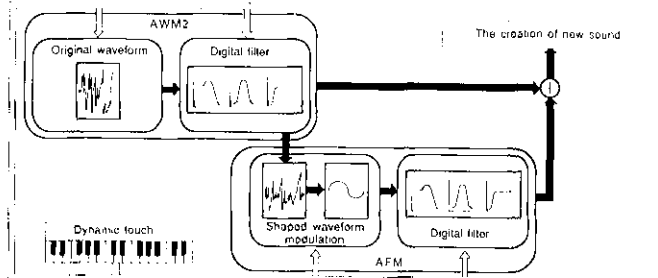

## Advanced Wave Memory 2 (AWM2)

AWM2 uses 16 bit linear sample reproduction with proprietary Yamaha convolution technology (digital filtering) that allows you to emphasize or cut any desired portion of the frequency spectrum with full realtime control.

## Advanced Frequency Modulation (AFM)

In addition to advancing beyond the FM synthesis capabilities of the DX7 and previous Yamaha synthesizers, AFM allows you to filter and envelope any AWM waveform and use the shaped waveform it as part of an FM algorithm to apply frequency modulation, creating partials that were not present in the original AWM waveform. This modulated waveform can be processed by additional digital filtering.

## Dynamic touch and control

One of the greatest advantages of RCM hybrid tone generation is that it fuses the realism of digital sampling with the expressive power of FM. Keyboard dynamics and controllers can be used to control nearly any aspect of the sound, allowing great musical expressiveness.

## The possibilities of RCM hybrid synthesis

The SY77 allows a wide variety of synthesis techniques to be used, and digital filtering is always provided for each AFM or AWM element. The following diagrams show how the RCM hybrid synthesis system can simulate many of the analog and digital synthesizers of the past.

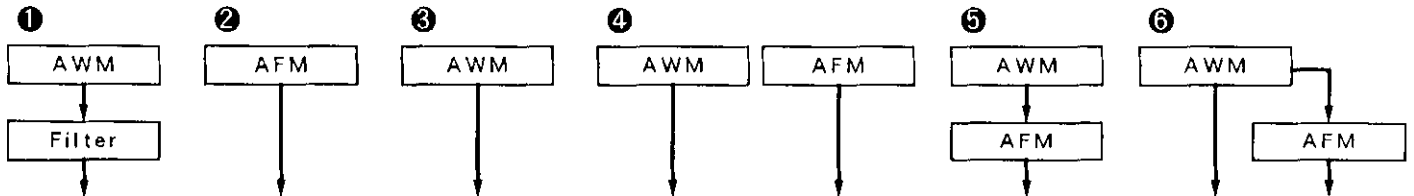

❶ Filter style "analog" synthesis: Single cycle AWM waveforms can be enveloped and filtered to simulate analog synthesizers. (Various sawtooth and pulse waves are provided, and the SY77's filters can be configured as 24dB/octave filters with resonance adjustable into oscillation.)

- ② Traditional FM: The AFM tone generator can be used alone to produce any sound that the DX series was capable of, and much more.
- ③ AWM sample playback: The AWM tone generator can be used along to playback high quality digital samples from internal AWM memory or an optional waveform card.
- ④ AWM sample playback mixed with FM: The sounds of the AWM and AFM tone generators can be layered.
- ⑤ FM modulated by AWM: AWM digital samples can be used to modulate one or more operators in an FM algorithm, for very complex FM sounds.
- ⑥ AWM sample playback + FM modulated by AWM: In a variation of ⑤, the original sound of the AWM sample can be mixed with the complex AFM sound.

For techniques which use both AWM and AFM (④ ⑤ ⑥) there are two additional possibilities.

- Both AFM and AWM can be used to create sustaining sounds.
- The AFM and AWM tone generators can be used “LA” style, with short transient AWM waveforms used to create an attack and the AFM tone generator used to create the sustain component of the sound (or vice versa).

Since each voice can use one two or four AFM or AWM elements, these synthesis strategies can be combined in complex ways.

# About the SY77: AFM and AWM voices

The SY77 produces sound using two proprietary Yamaha technologies; **Advanced Frequency Modulation (AFM)** synthesis and **Advanced Wave Memory (AWM)**. A special **Drum Voice** assigns a different AWM percussion sound to each note of the keyboard.

## AFM — Advanced Frequency Modulation

Frequency Modulation (FM) is a patented Yamaha technology for producing complex and musical controllable sounds, and was first made famous by the DX7 synthesizer. The SY77's Advanced FM (AFM) takes FM synthesis to new levels of realism, expression, and programmability.

Each of the six FM operators in the SY77 can use one of 16 different waveforms, and be connected to each other in 45 basic algorithms (patterns). In addition, each operator has two inputs which can be modulated by feedback from any other operator, from a noise generator, or from an AWM sample. Compared to previous FM instruments, many parameters have a wider range of control, and the SY77 envelope generators have six segments with looping.

AFM can produce sounds that change dramatically in response to your playing, allowing a wide range of expressiveness.

## AWM — Advanced Wave Memory

Advanced Wave Memory (AWM) is a patented Yamaha technology for storing and reproducing digital sound. The SY77 contains 2 Mwords (4 Mbytes) of AWM samples in Read Only Memory (ROM), including piano, strings, choir, and percussive sounds among many others. Optional cards can be inserted into the front panel WAVEFORM slot to make additional sounds available. The sounds are sampled in 16-bit linear format with a maximum sampling frequency of 48 kHz.

AWM sounds are high-quality digital recordings of actual instruments.

## A voice consists of one two or four Elements

Each sound that you have been playing from the SY77's keyboard is defined as a Voice, and consists of one two or four Elements. (The drum voice explained below is a special case.) Each of these elements is actually the equivalent of an independent synthesizer; either AFM or AWM.

An element can be set to produce sound for only a specific range of the keyboard, or for a specific range of velocities. This allows you to create a voice which produces different sounds for different ranges of the keyboard, or for loudly or softly played notes.

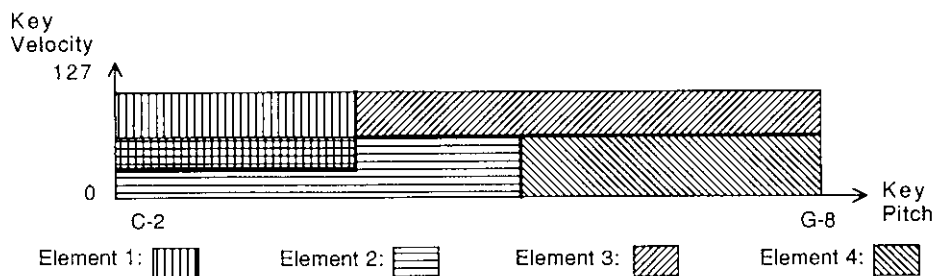

The one two or four elements in a voice can produce many types of keyboard split and layer effects.

On earlier Yamaha synthesizers such as the DX7-II, layers and splits were created by combining two or more Voices into a "Performance". This meant that sometimes you played Voices and other times you played Performances. However on the SY77, layers and splits can be included in a voice, so you can simply select a voice and play without considering whether it contains layers or splits.

**Play up to 16 AFM notes and 16 AWM notes at once**

The SY77 contains two tone generators; an AFM tone generator and an AWM tone generator. The AFM tone generator can produce up to 16 simultaneous notes of FM sound, and the AWM tone generator can produce up to 16 simultaneous notes of digitally sampled sound.

Some voices consist of only one element, some of two elements, and others of four elements. (The Voice mode setting inside each voice determines how many elements are used.) The important thing to remember is that up to a total of 16 notes of AFM sound and 16 notes of AWM sound can be sounding at any time. If a voice plays two or more elements for a single key, the sound will be more complex and richer, but you will be able to play fewer simultaneous notes.

**A Drum voice consists of 61 percussive sounds**

In addition to the "normal" voices explained above which consist of one two or four elements, the SY77 provides a special type of voice; the Drum voice. A drum voice has no elements, but consists of a different AWM sample for each of the 61 keys of the SY77 keyboard.

A drum voice can be played from the keyboard just like a normal voice. Usually you will use a sequencer to play a drum voice, providing drums and percussion accompaniment. Either the SY77's internal sequencer or an external MIDI sequencer can be used to play a drum voice.

There is no distinction between normal voice memory and drum voice memory; either type of voice can be stored in any of the voice memories.

# About the SY77: filter, pan, and effects

Each of the one two or four elements in a voice has two independent digital filters, and is sent through its own pan table. The SY77 also has four built-in digital effect processing (DSP) effect units, and effect settings are stored as part of each voice.

## Two realtime digital filters for each element

Each AFM or AWM element in a voice includes two 12 dB/octave realtime digital filters, each filter independently controlled by its own envelope generator (EG). One filter is fixed as a Low Pass Filter (LPF) and the other filter can be used either as a LPF or a High Pass Filter (HPF). This allows you to use the two in conjunction to create a 12 dB/octave Band Pass Filter (BPF) or a 24 dB/octave LPF. Veterans of analog synthesizers will be happy to hear that the filter resonance (or "Q") can be adjusted all the way into filter oscillation.

Since a voice can consist of one two or four elements, a single voice can use 2, 4 or 8 independent filters.

## Dynamic pan table for each element

Each element in a voice is sent through a pan table (64 preset and 32 user pan tables are provided) that determines how the sound will move between the left and right outputs. Each pan table has its own EG, and also allows you to select a pan source (velocity, key note number, or LFO). Another controller can be used to further bias the panning movement.

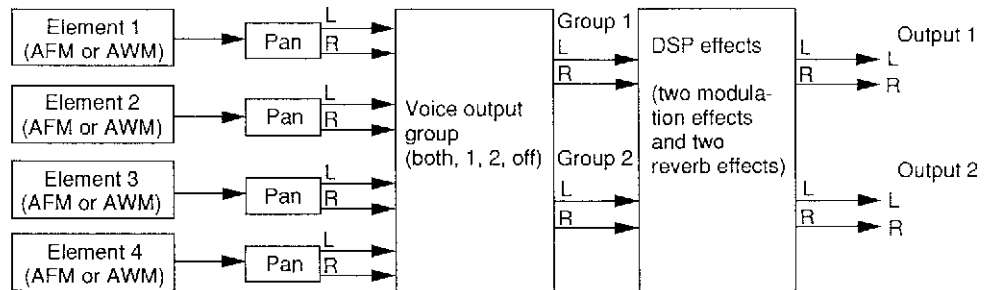

## Four DSP effects

The stereo output from the voice is sent through the voice output group selector (both, group 1, group 2, or off) to the DSP effects section. The SY77 contains two modulation-type effect units and two reverb-type effect units.

Each modulation-type effect unit can produce four different effects; chorus, flanger, symphonic, or tremolo. Each reverb-type effect unit can produce 40 different effects, including several types of reverb, delay, tone control, distortion, and various combinations of these. All effect parameters are fully adjustable. The sound from the two output groups can be sent through these four effect units in three different routes.



**AFM x AWM x Filtering = the SY77**      The SY77 can utilize most of the programming techniques of previous synthesizers; FM, sample playback, and realtime filtering. This means that the SY77 can produce the sounds of the classic 24 dB/octave analog synthesizers of the past, the FM sounds of the DX series, the sampled sounds of many of today's instruments ... and also sounds that have never been heard before.

# About the SY77: multi-timbral sequencing

In Multi mode, the SY77 acts as 16 synthesizers, each able to be controlled independently and produce its own sound. The SY77's built-in 16-track sequencer records and plays back musical data. Each track 1–15 contains an independent musical performance; notes, pitch bends, controller movements, and program changes. You can create 99 patterns and place them in track 16 (the pattern track). Using the sequencer together with multi mode lets you use the SY77 to create sixteen-part compositions.

## In Multi mode the SY77 is 16 independent synthesizers

In Voice mode, the SY77 plays a single voice in response to the notes you play and the controllers (wheels, foot pedals, etc.) you move. However in Multi mode, the SY77 acts as 16 completely independent synthesizers, each sounding a different voice and responding independently to notes and controller movements.

## Use a sequencer to play a multi

To create multi-part compositions, you will play and record one part at a time using a sequencer.

A sequencer is a device that records music, but instead of recording the *sound* of a musical performance, a sequencer records the *musical data*; the precise timing of the keys you press, program changes, movements of the sustain pedal, foot controllers, and wheels, etc. When this data is played back, the result is exactly the same as if you were playing the keys and moving the controllers. You can record Tracks (musical parts played by one instrument) one at a time, and then playback all the tracks together.

The SY77 sequencer has 16 tracks, and each track plays the corresponding voice of a Multi. (A multi can also be played by an external sequencer connected to the MIDI IN terminal, and the sequencer can also transmit data from MIDI OUT to control external synthesizers.) For example, you might select a piano voice for voice 1 and record the piano part on track 1, select a strings voice for voice 2 and record the strings part on track 2, and so on for all sixteen tracks and voices.

SEQUENCER				MULTI	
Measure	1	2	3	...	Each timbre in the multi can play a different voice
Track 1				→	Piano
Track 2				→	Strings
Track 3				→	Brass
...					
Track 16				→	Percussion

## Three ways to record — realtime, punch-in, and step

The SY77 sequencer lets you record in three ways.

**Realtime:** In realtime recording, notes and controller movements are recorded with the exact timing that you play them.

**Punch-in:** Punch-in recording is like realtime recording, except that the data is recorded only for the measures you specify. This is useful for fixing minor mistakes in an otherwise well-recorded track.

**Step:** Step recording allows you to enter notes and other data one step at a time. This allows you to record complex musical phrases that would be impossible for a human to play, and also can be used to edit individual notes that have already been recorded.



## Sequence editing jobs

A wide variety of “sequence editing jobs” are provided to allow you to modify the musical data that has been recorded.

- Tracks can be moved forward or backward in time, mixed, or deleted.
- Measures can be copied, erased, deleted, or created.
- For specified measures you can quantize the data (adjust each note to a specified timing precision), transpose it to a different pitch, adjusted the velocity (playing strength), or modify the gate time (note length).

## 99 Patterns can be used in a song

Track 16 is a dedicated Pattern track. In pattern mode, you can create up to 99 patterns; short phrases one to thirty-two measures long. Patterns are especially suitable for rhythm parts; since the same basic drum pattern may be repeated many times during a song, you can record a single pattern and place it in the pattern track wherever you want it to play back. When song playback reaches that point, the pattern will play back along with track 1–15.

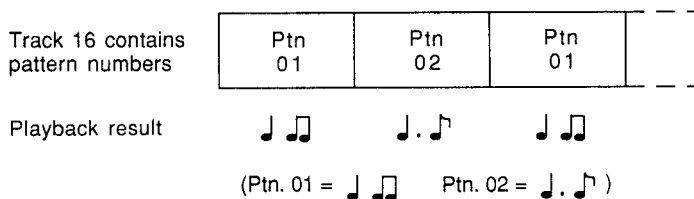

## Pattern recording — realtime or step

Patterns can be created either by realtime recording or step recording.

**Realtime recording:** Since patterns are sometimes used for drum and percussion parts, realtime pattern recording has features that make it easy for you to build up complex drum parts. There is no need to play all the rhythm instruments at once. When you record a pattern in realtime, the pattern will continue repeating, and you can add each instrument one by one as the pattern repeats.

**Step recording:** When step recording a pattern, the LCD will graphically indicate exactly where you are in the pattern. You can move back and forth, entering notes on any beat to build up a pattern of any complexity.

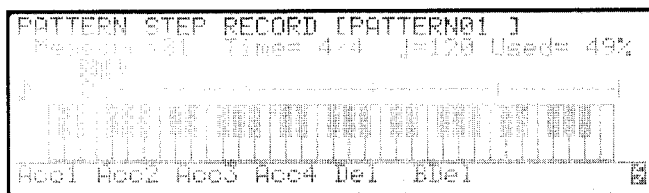

# Front panel: left side

---

In order to understand the rest of this manual and take full advantage of the SY77, you will need to know the names and uses of the controls and other features of the front panel. This page explains the left side of the front panel, including the LCD.

## Keyboard:

The 61-note keyboard of the SY77 is sensitive to key-on velocity and to channel aftertouch.

## Pitch and modulation wheels:

The PITCH wheel bends the pitch up or down, and is spring-loaded to return to center position. The MODULATION 1 wheel affects the sound as specified by the voice parameters; usually controlling the amount of vibrato or tremolo. The MODULATION 2 wheel also affects the sound as specified by the voice parameters, but is center-detented to help you return it to exactly center position.

## Disk drive:

The 3.5" 2DD floppy disk drive can economically store large amounts of the various types of data used by the SY77. The disk drive indicator LED will light when the disk is being read or written. *Never attempt to remove the disk while this LED is lit. Doing so could damage the disk.*

Insert the disk with the label facing up, from the end with the metal shutter. To remove the disk, press the button at the lower right of the drive.

## DATA card slot:

An optional RAM card (MCD64) can be inserted into the DATA slot to store data for the SY77's tone generator.

## Waveform card slot:

An optional waveform ROM card can be inserted into the WAVEFORM slot to provide additional AWM sounds.

## Volume sliders:

These sliders regulate the output volume from the two pairs of stereo output on the rear panel.

## Liquid Crystal Display (LCD):

The 240 x 64 pixel LCD is backlit for readability even in dark locations. Adjust the CONTRAST control on the rear panel to suit your viewing angle.

## Mode select keys:

The functions of the SY77 are divided into five modes. Press one of these buttons to select the mode, and the LED above the button will light red to indicate the selected mode.

The SY77's Synthesizer is always in one of two modes; Voice mode or Multi mode. One of the LEDs above these two keys will always be lit (green, if neither Voice nor Multi mode is selected) to indicate which mode the synthesizer is in.

The SY77's Sequencer is always in one of two modes; Song mode or Pattern mode. One of the LEDs above these two keys will always be lit (green, if neither Song nor Pattern mode is selected) to indicate which mode the sequencer is in.

The Utility mode LED is either red (when Utility mode is selected) or off (when a different mode is selected).

## Edit/Compare:

Press this button to edit the data of the currently selected; Voice, Multi, Sequencer Song, or Sequencer Pattern. In voice edit or multi edit mode, pressing this button allows you to compare the original data with the edited data.

## Copy:

While editing, this button is used to copy various types of data.

## Effect Bypass:

At any time, pressing this button will allow you to hear the sound without the DSP effects. The red LED will light to indicate that the effects are bypassed. To defeat effect bypass, press the button again.

## Sequencer control:

The SY77 sequencer can be used at any time, even while editing. The data played or recorded will depend on whether the sequencer is in Song or Pattern mode.

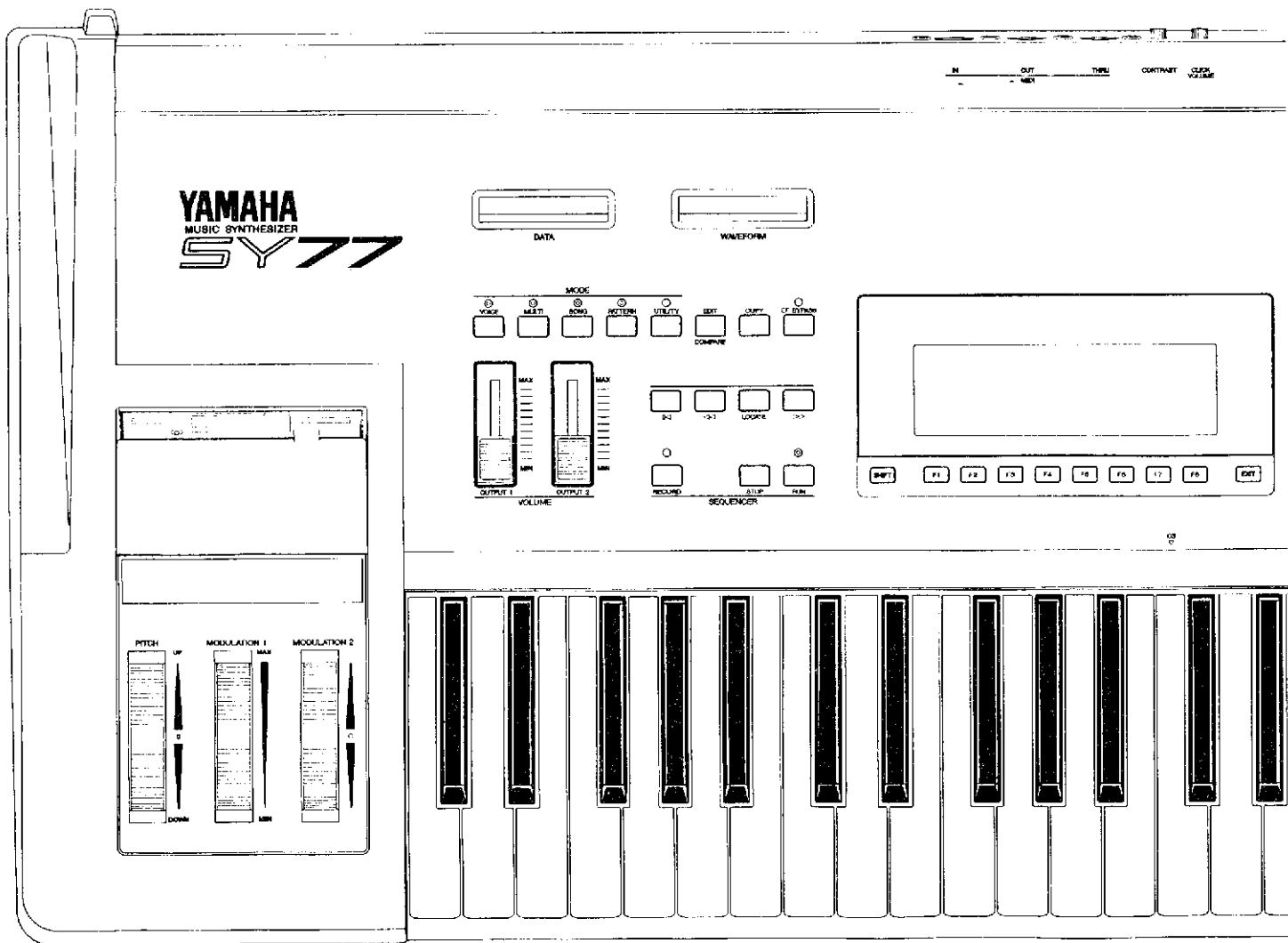

- ⏪ : Move to the beginning of the song
- ⏮ : Move back one measure (press and hold to rewind)
- LOCATE : Move to a previously specified location
- ⏭ : Move forward one measure (press and hold to fast forward)
- RECORD : Start recording (during recording, LED lights red)
- STOP : Stop playback or recording
- RUN : Begin playback (blinks green on each beat of the click, and blinks red to indicate the first beat of the measure)

**Shift:**

While the SHIFT button is held down, the function keys F1–F8 will act as F9–F16. Also, pressing the JUMP key while SHIFT is held down will mark the current location.

**Function keys:**

In some jobs, the bottom line of the LCD will display a function for F1–F8 (F9–F16 while the Shift key is held down). These keys are used in various ways, such as selecting menu items shown in the function key display, moving the cursor in the display, or executing a function shown in the function key display.

**Exit:**

This key moves back to where you last were before entering the level you are now in; i.e., it moves back to the previous branch of the function tree.

# Front panel: right side

This page explains the front panel features to the right of the LCD.

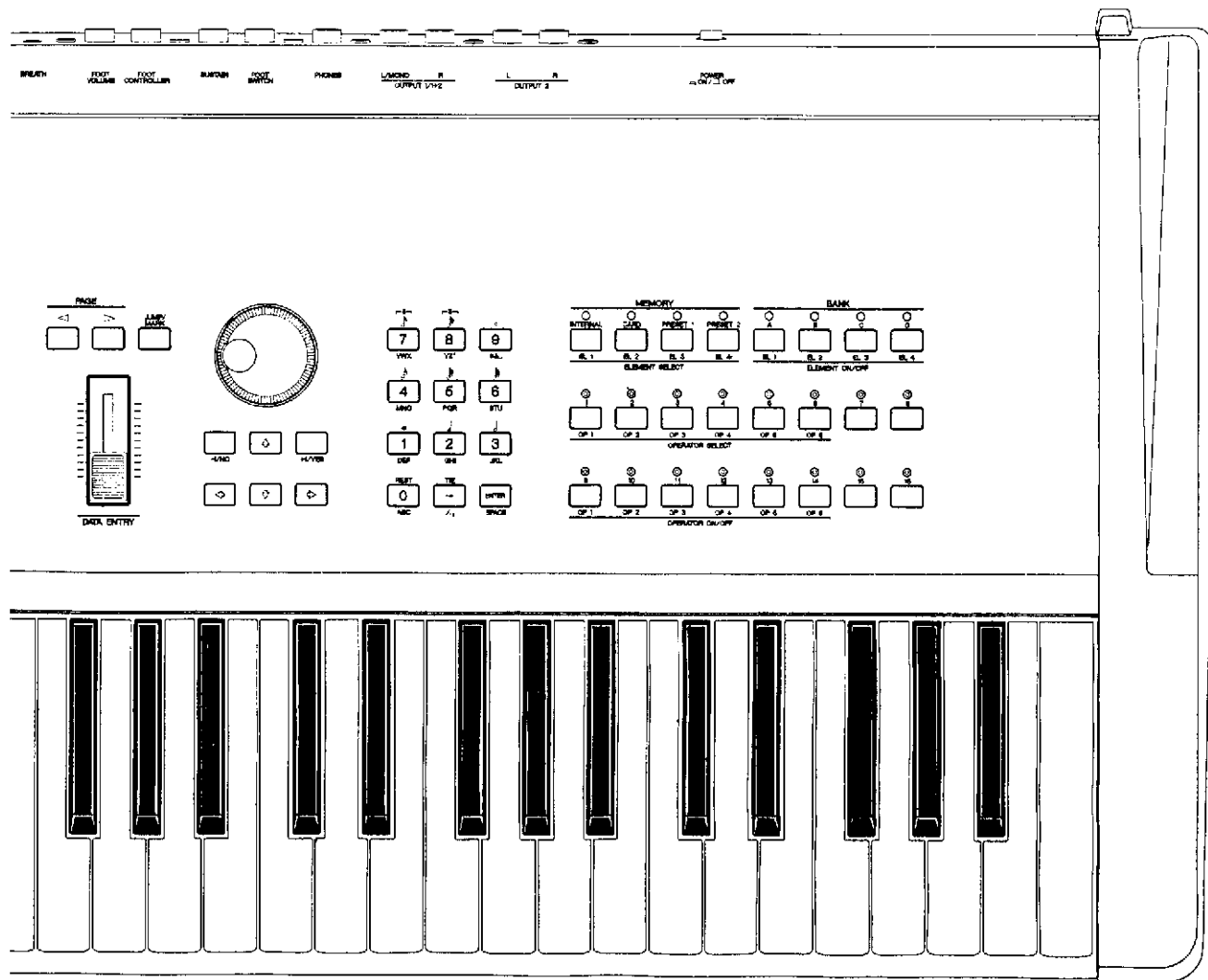

### **Page <>:**

These keys move to the next or previous function within the same level; i.e., they move from branch to branch of the tree of functions.

### **Jump/Mark:**

The LCD of each function in the SY77 has a "system page number", which is displayed at the upper right of each LCD. If you know the number of the page to which you want to jump; press JUMP, use the numeric key pad to enter the page number, press ENTER, and you will be taken to the specified page.

If you press MARK while holding SHIFT, the current page will be marked. Later when you are in another page and wish to return to the marked page, press JUMP and then ENTER, and you will be taken to the previously marked page. (The page you jumped from will now be marked.)

### **Data entry slider, Data entry wheel, -1/+1:**

The data entry slider, data entry wheel, and -1/+1 keys are all used to modify the data value indicated by the cursor.

When you move the DATA ENTRY slider, the data is directly set to the value indicated by the slider position; i.e., use the data entry slider to "absolutely" specify the data.

The data entry wheel can be rotated freely in either direction, and will change the current data value continuously. In job or voice directories it will also move the cursor around the screen.

The -1/+1 buttons will decrease/increase the current data value in steps of one. (These buttons also act as "yes/no" or "on/off" for various functions.)

The data entry wheel and -1/+1 buttons can also be used to select programs (voice or multi).

The slider, wheel, and -1/+1 will not necessarily act in the same way for all functions. Exceptions will be noted when each function is explained.

### **Cursor keys:**

Use these keys to move the cursor in the LCD to select items or data. (Simply moving the cursor will not modify the data.)

### **Numeric key pad:**

Use these keys to enter data as an absolute number.

- to select a voice or multi
- after pressing JUMP to specify the page to which you want to jump
- to directly enter a value for the data indicated by the cursor
- to directly select an item from a directory

When step recording sequencer data, the numeric key pad is used to enter the note values printed above each key. When specifying a voice name etc., the numeric key pad enters the characters printed below each key.

In general to enter a value, use keys 0-9 to specify the value, press +/- to change the sign if necessary, and press ENTER. In some cases, ENTER is not necessary.

### **Memory source select:**

When selecting a memory, press one of these buttons to select the source; INTERNAL (internal user memory), CARD (card memory), and PRESET 1 or 2 (internal ROM preset data). The LED above each button will light to indicate the selected memory.

When in Voice Edit mode, these buttons are also used to directly select elements 1-4.

### **Bank select:**

When selecting a Voice program, press one of these buttons to select the bank; A-D. The LED above each button will light to indicate the selected bank.

When in Voice Edit mode, these buttons are also used to turn elements 1-4 on/off.

### **Program select:**

These keys are normally used to select programs (voice or multi). The selected button will light red. In addition, they have the following special uses.

Voice edit mode: While you are editing an AFM element, buttons 1-6 select operators 1-6, and buttons 9-14 turn operators 1-6 on/off.

Sequencer mode: Buttons 1-16 will mute/unmute tracks 1-16. The LEDs will light green to indicate tracks which contain data. Muted tracks which contain data will blink green during playback. Tracks selected for recording or editing will light red.

# Rear panel

In order to connect the SY77 to other devices (an amp/speaker system, MIDI equipment, footswitches, etc.), you will need to know the names and uses of the various items on the rear panel.

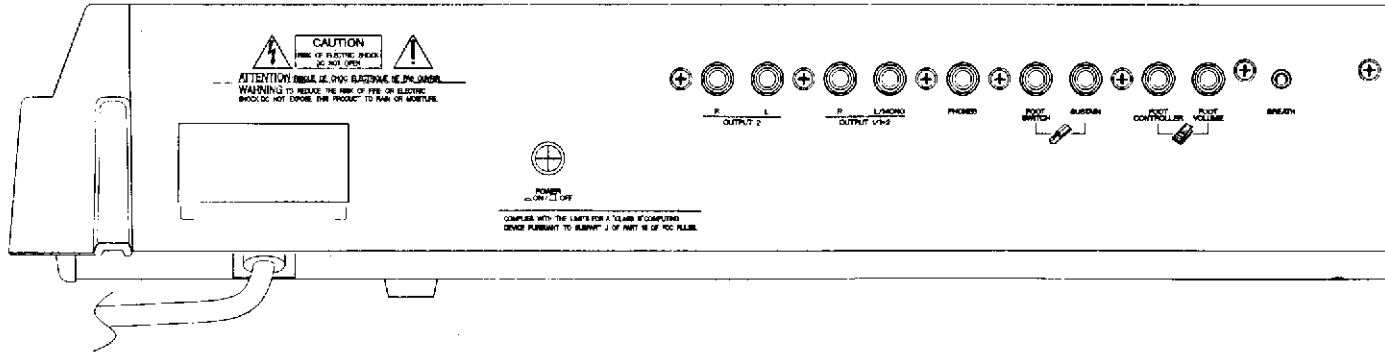

## MIDI IN, OUT, THRU:

Any MIDI device (sequencer, keyboard, WX7/11 wind controller, G10 guitar controller, etc.) can be connected to MIDI IN to play the sounds of the SY77.

Data produced by the SY77 keyboard and the SY77 internal sequencer is transmitted from MIDI OUT. By connecting a tone generator module or synthesizer to this terminal, you can play it from the SY77 keyboard.

The data received at MIDI IN is re-transmitted unchanged from MIDI THRU. Another MIDI device connected to this terminal will receive the same MIDI data that the SY77 receives.

## Contrast:

This knob adjusts the contrast of the LCD. Adjust it to suit your viewing angle. (At extreme settings the display will not be readable.)

## Breath:

By connecting an optional BC1 or BC2 breath controller to this jack, you can expressively control various aspects of a sound by blowing into the breath controller. For example, a voice might be programmed so that the tone or volume changes in response to breath controller signals. (The effect will depend on the breath control sensitivity parameter settings of each voice.)

## Click volume:

This knob adjusts the volume of the click (metronome) produced by the sequencer.

## Foot volume:

An optional foot controller (FC7, FC9, etc.) can be connected here to regulate the overall volume of the SY77.

## Foot controller:

An optional foot controller (FC7, FC9, etc.) can be connected here to perform the function (foot controller, portamento time, etc.) determined by the Assignable Foot Switch setting of Utility mode.



- Sustain:** An optional foot switch (FC4, FC5) can be connected here to act as a sustain pedal.
- Foot switch:** An optional foot switch (FC4, FC5, etc.) can be connected here to perform the function (hold on/off, portamento on/off, etc.) determined by the Assignable Foot Switch setting of Utility mode.
- Phones:** A pair of stereo headphones can be connected here to hear the combined stereo sounds of outputs 1 and 2.
- Output 1/1+2 (L/MONO, R):** If the OUTPUT 2 L/R jacks are not plugged in, these jacks will output the combined stereo signal from group 1 and group 2 of the DSP effects unit. If the OUTPUT 2 L/R jacks are plugged in, these jacks will output the sound from the group 1 stereo output of the DSP effects unit.  
If only the L/MONO jack is used, it will carry the combined output of L and R. (Use the L/MONO jack if your mixer/amp system has only one input.)
- Output 2 (L, R):** These jacks output the sound from the group 2 stereo output of the DSP effects unit. If your mixer/amp system has four or more inputs, using both the OUTPUT 1 and the OUTPUT 2 jacks will allow you to treat the two output groups in different ways, perhaps by panning them to different locations, or processing them through different external effect devices.
- Power switch:** The power is on when this switch is pressed. The front panel display will light when the power is turned on.
- Power cable:** Plug the power cable into an AC outlet of the correct voltage.

# How to move around: job directories

The functions of the SY77 are organized into five main Modes and four editing modes. Some modes have a Job Directory that shows the various Jobs (functions) in the mode. Move to the desired function by selecting a job from the job directory.

## Five main modes (1)

The SY77 operates in five main modes. Press one of the five mode select buttons to enter the corresponding mode. (A red LED will light to indicate the selected mode.)

Press	to enter	where you can
VOICE	Voice mode	Select and play a Voice.
MULTI	Multi mode	Select and play a Multi.
SONG	Song mode	Playback the song in sequencer memory.
PATTERN	Pattern mode	Select and playback a pattern from sequencer memory.
UTILITY	Utility mode	Make overall settings for the SY77, manage disk and card data, etc.

## Play modes and Edit modes (2)

While in voice, multi, song, or pattern mode, press EDIT to move to the corresponding edit mode. For example Voice Edit mode is where you modify the settings that make up a voice, and Song Edit mode is where you modify the data that makes up a song. (There is no "utility edit" mode.)

Press	to enter	then press	to enter
VOICE	Voice mode	EDIT	Voice Edit mode
MULTI	Multi mode	EDIT	Multi Edit mode
SONG	Song mode	EDIT	Song Edit mode
PATTERN	Pattern mode	EDIT	Pattern Edit mode

To leave an edit mode, simply re-select any of the five main modes (or press EXIT from the top level of the edit mode to return to the main mode from which you came).

## Select a job from the job directory (3)

Whenever a mode or function is sub-divided into more than one job, there will be a "job directory" that lists the various items or operations. For example, when you enter Multi Edit mode, the following display will appear.

```

MULTI EDIT                                400
01: Voice                                01
02: Volume                                01
03: Tuning                                01
04: Filter                                01
05: Filter                                01
06: Filter                                01
07: Filter                                01
08: Filter                                01
01 02 03 04 05 06 07 08
  
```

This lists the various parameters that can be adjusted in Multi Edit mode; 1.Voice, 2.Volume, 3.Tuning, etc.

To select an item from a job directory, use the arrow keys to move the cursor to the desired item and press ENTER. For example, if from the above display you press  $\nabla$  once to move the cursor to "2.Volume" and press ENTER, the following display will appear.





To return to the job directory, press EXIT.

#### Function keys (4)

Sometimes a job will be divided into two or more screens. For example, “2.Volume” is divided into two jobs; one to set the volume for voices 1–8 and the other to set the volume for voices 9–16. Notice that the bottom line shows “1–8” (above function key F1) and “9–16” (above function key F2). The “1–8” is displayed in inverse video to indicate that the volumes of voices 1–8 can be edited. To edit the volumes of voices 9–16, press function key F2.

Whenever function key assignments are displayed in the bottom line of the LCD, the current selection is indicated in reverse video. Press a function key to move to the desired job.

#### Move between jobs using <D> (page) (5)

Suppose that you wanted to move from the “2.Volume” job to the “3.Tuning” job. You could press EXIT to return to the job directory, and then press 3 and ENTER to move to “3.Tuning”, but there is a faster way.

To move between jobs of the same level (i.e., inside the same job directory), use the PAGE <D> keys. For example if you are now in the “2.Volume” job, pressing PAGE <D> would take you to the “1.Voice” job, and pressing PAGE >D> would take you to the “3.Tuning” job. When moving to a nearby job, this is usually faster than returning to the job directory.

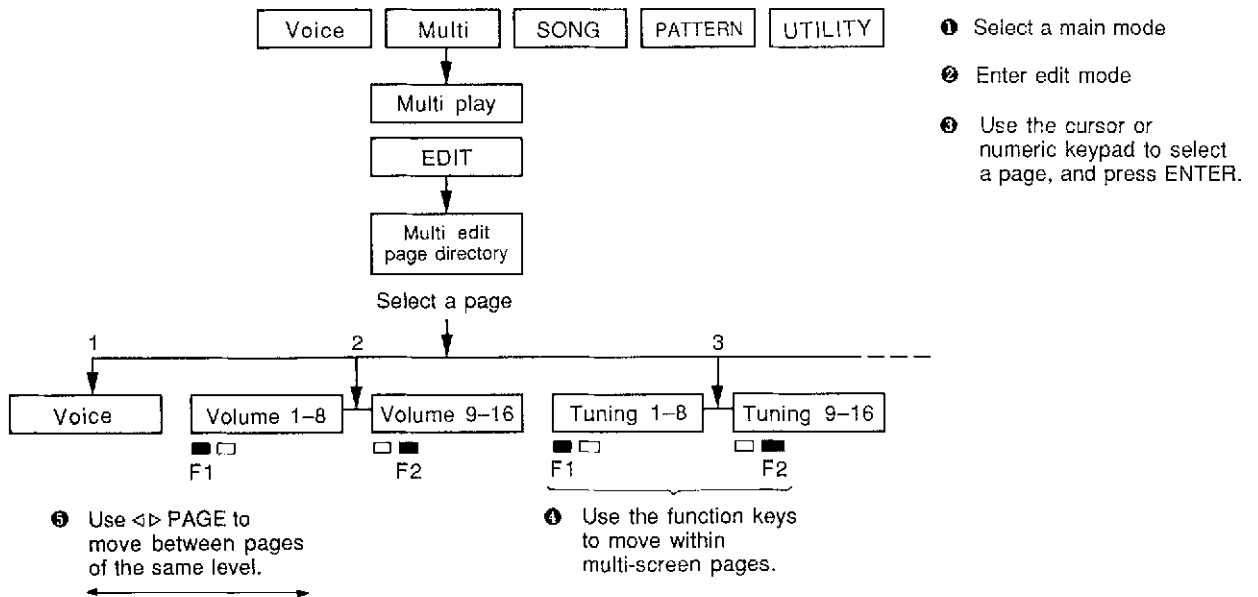

# How to move around: the jump function

If you already know the exact function you need to use, it is possible to **Jump** directly to a specific page number instead of working your way through the job directories. The jump function also allows you to repeatedly jump back and forth between two jobs.

## Jump to a specified page number

If you need to move to a distant job, it may sometimes be necessary to press EXIT several times, and then move down through two or more job directories. In such cases, it is much faster to jump directly to a specific page.

You may have noticed that most page displays have a unique three-digit number in the upper right corner. This is the Display Page number. For example, "Multi edit 2. Multi Volume" is page #402. If you frequently need to adjust the settings of this page, remember this page number. Then, no matter where you are, you can press JUMP, 4, 0, 2, and ENTER to jump instantly to that page.

1. Press JUMP.

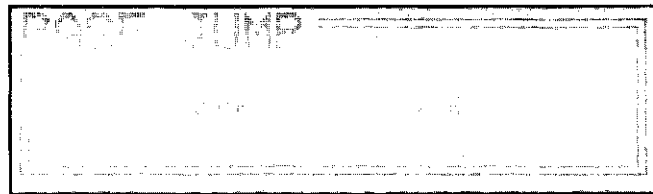

2. Enter the three digit page number.

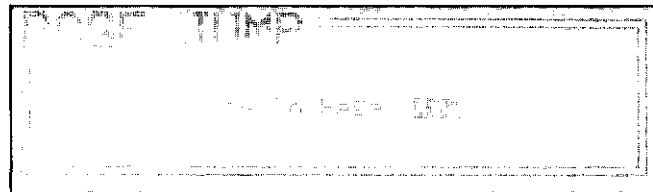

3. Press ENTER and you will jump to the specified page.

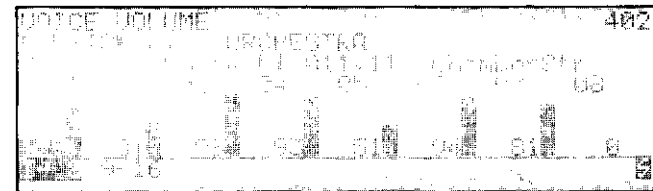

While you are becoming familiar with the SY77 it will probably be easier for you to select the desired page while viewing a page directory. However as you gain more experience, you may find it convenient to use the JUMP key to go directly to frequently-used pages.

## Jump between two marked pages

It often happens that you will need to repeatedly make adjustments in two different pages, which may be widely separated. The jump/mark function allows you to jump back and forth between two pages.

Suppose you are in song edit job directory, and need to adjust the volume levels of the voices in the multi.

1. Hold down the SHIFT key and press JUMP. The current page will be marked, and the page number will displayed in inverse with a triangle mark to indicate this.

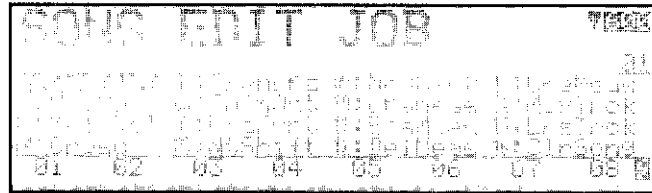

2. Then move to the other page, either by jumping to the page number, or by moving through the job directories.



3. To return to the previously marked page press JUMP and then ENTER without entering a page number.

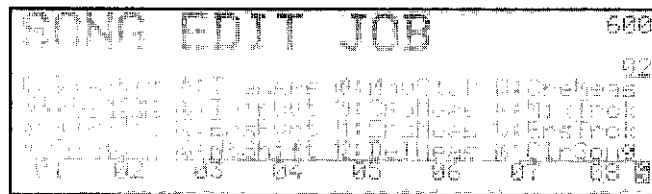

4. To jump back to the page you first marked, press JUMP and then ENTER again. In this way, pressing JUMP and then ENTER will jump back and forth between the two pages. Each time you jump, the mark is shifted to the page you jumped from. If you return to that page by moving through the modes and job directories in the usual way, you will find that it is marked by the inverted page number and triangle.

**Note:**

The two pages used in this example are located in two different modes. Whenever you leave multi edit (or voice edit) mode after modifying the data, either by pressing EXIT or by using the Jump function, you will pass through the Auto-Store screen, and must press F6 (Ret) to return to editing mode, F7 (Quit) to quit without storing the changes, or F8 (Go) to store the data.

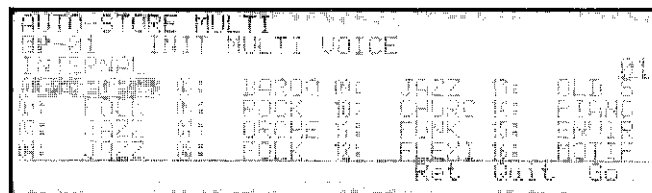

If the data has not been modified, this Auto-Store screen will not appear.

# How to enter data

To select a voice, adjust a parameter, or give a name to a newly created setting, you will need to enter various types of data into the SY77. The  $-1/+1$  keys, data entry slider, and data entry dial provide various ways to enter data. Use the data entry method that is most appropriate for each situation. (The following page explains how to use the numeric key pad.)

## Select the data to enter

First, use the arrow keys  $\triangleleft \triangleright \triangleup \triangledown$  to move the inverse cursor to the data you want to modify.

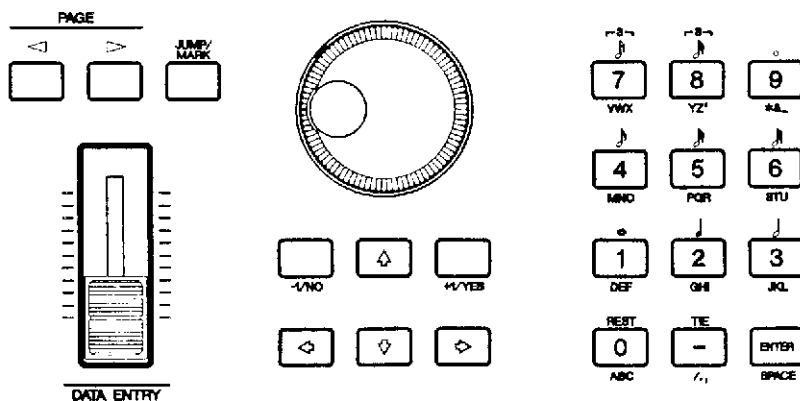

Move the cursor in the LCD

Next you will modify the value using one of the following;  $-1/+1$  keys, data entry wheel, data entry slider, or the numeric key pad. The method you use will depend on how you want to modify the data.

## $-1/+1$ (no/yes)

If you want to decrease or increase the existing data value one step at a time, use the  $-1/+1$  keys. Each time you press the  $-1$  or  $+1$  key, the data will decrease or increase one step. This method allows you to move in precise steps, but can take a long time when you need to make a major change in the value.

Some parameters consist of a “off/on” setting, and sometimes you will be asked to reply “no/yes” to a question (such as “do you really want to do this?”). In such cases, press  $-1$  to turn something off or to answer “no”, and press  $+1$  to turn something on or to answer “yes”.

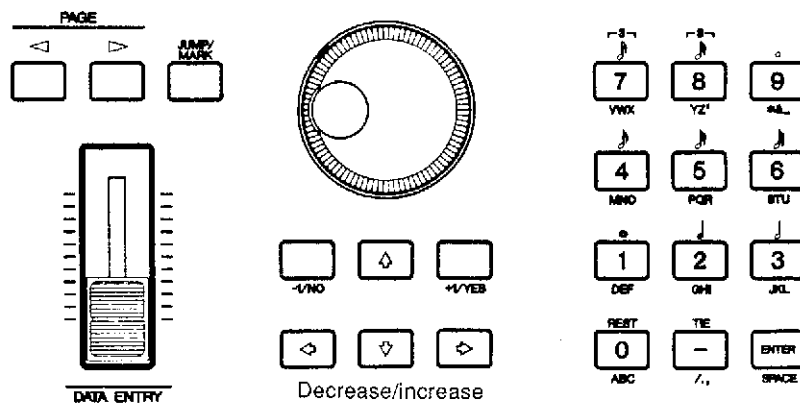

Decrease/increase the data one step at a time

## Data entry wheel

If you want to decrease or increase the existing data value by a significant amount, use the data entry wheel. As you rotate the wheel to the right (clockwise) the data will increase, and as you rotate the wheel to the left (counter-clockwise) the data will decrease. The wheel rotates freely; it modifies the data by its *movement*, not by its position. Like the  $-1/+1$  keys, the data entry wheel modifies the existing value, but is more suitable for making larger continuous changes. In job or voice directories, the wheel can be used to select jobs and voices.

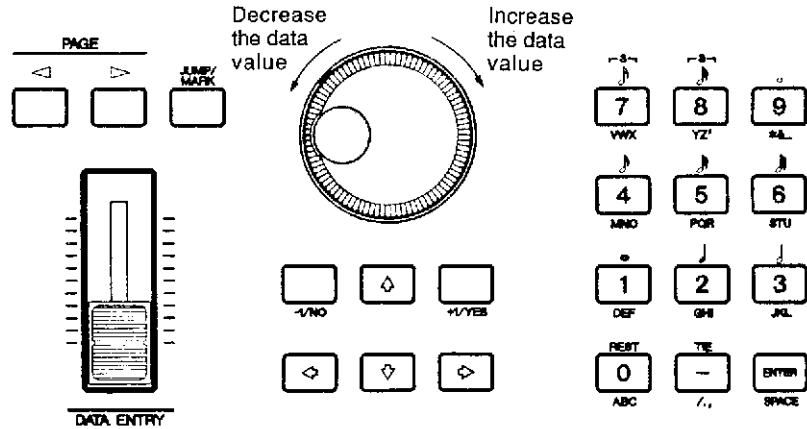

## Data entry slider

If you want to set a data value to some setting relative to the entire range of that value (for example "maximum", "minimum", or "about 90% of maximum"), use the data entry slider. When you move the slider, the data value is immediately changed to correspond to the position of the slider. The range of the slider will match the range of the parameter value. For example if the parameter being modified has a value range of 0–127, pulling the slider fully towards you will set a value of 0, and pushing the slider fully away from you will set a value of 127. Setting the slider exactly in the middle of its range would set a value of 64.

Since the range of the slider always matches the range of the parameter you are adjusting, there is no need to remember the range of the parameter; just move the slider to the position that corresponds to the relative setting you want.

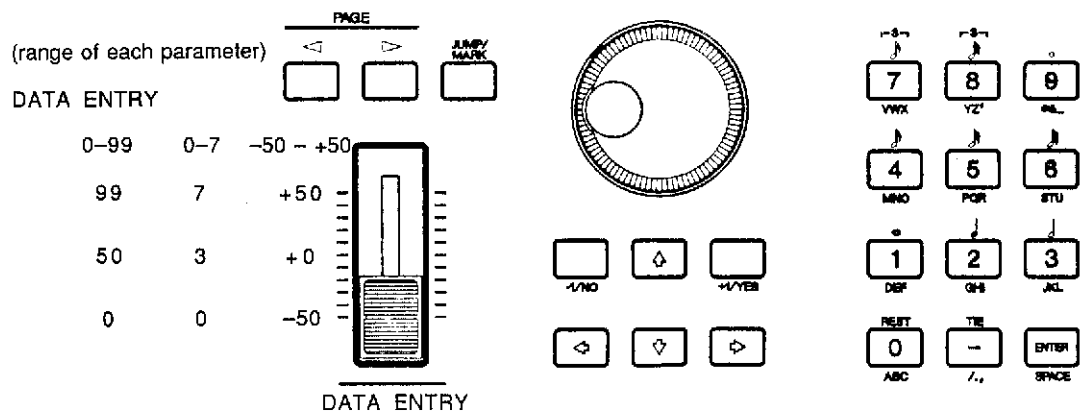

# How to use the numeric key pad

The numeric key pad can be used to enter an absolute data value, and also to enter characters for a memory name or disk file name.

## How to enter absolute numerical data

If you want to set a data value to some specific number (for example “57” or “121”), use the numeric key pad. Press one or more keys 0–9 to specify the number, press the – key to change the sign if necessary (when entering a negative number), and press ENTER. For example if you wanted to enter the number “–18”, you would press 1, 8, –, ENTER. If the data value has a three-place range (such as 0–127), there is no need to add a zero in front.

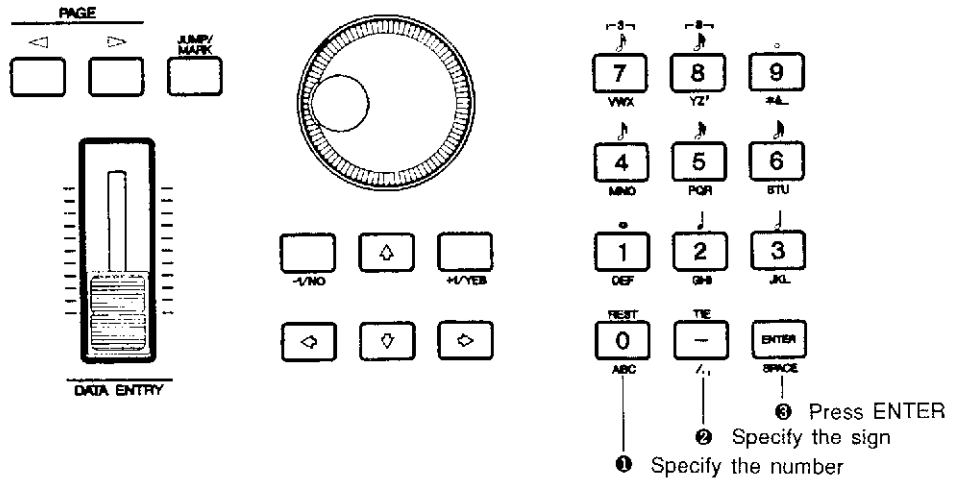

In most displays, the first digit you enter from the numeric key pad will be displayed blinking with an asterisk after it. When you enter the second digit the number will be finalized.

## How to enter character data

You will sometimes need to enter character data to specify a voice name, multi name, file name, etc. When the currently selected parameter requires that you enter character data, the numeric key pad will act in a different way than usual. To try this out, jump to the Voice Name page by pressing the following keys in order; JUMP, 2, 2, 9, ENTER. The following display will appear.

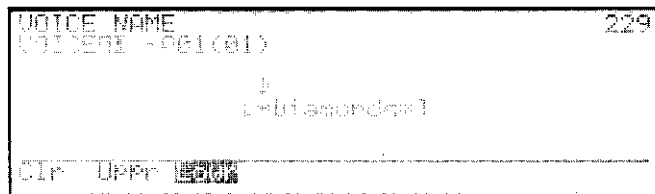

This display is essentially the same as for any other job that requires you to enter character data. Press F1 (Clr) to clear the currently set name, and press F2 (Uppr) or F3 (Lowr) to select uppercase or lowercase letters.

Notice that below the 0 key are printed the characters "A", "B", and "C". Press the 0 key, and the numeral "0" will appear. Press it again for the character "A", again for "B", and again for "C". Press it once more and "0" will reappear. In this way, each time you press a key, the character indicated by the cursor will alternate through the alphabetical characters printed below it and the numeral printed on the key itself. (If you press another of the numeric keys, the cycle will begin from the first character.) Notice that the third press of 8 is an apostrophe, that 9 gives you an asterisk, ampersand, and an underline character, and that - enters a hyphen, slash, comma, and period.

Other characters are available in addition to the characters entered using the numeric key pad. These characters can be selected using the DATA ENTRY slider or the -1 +1 keys. Moving the DATA ENTRY slider will scroll through all available characters in the following order.

(Space) ! " # \$ % & ' ( ) \* + , - . / 0~9 : ;  
< = > ? @ A~Z [ \ ] ^ \_ ` a~z { | } ~ (Space.)

Use the <D> keys to move the cursor, and enter characters for the desired name. Pressing the ENTER (space) key will enter a blank and move the cursor to the right.

### **Other uses of the numeric key pad**

In step recording mode, the numeric keys specify the note value printed above each key. For example key 1 will enter a whole note and key 6 will enter a 32nd note. Details will be explained in the section on step recording.

In jobs where you are required to set parameters and execute, you will execute the specified job by pressing the ENTER button. Details will be explained when necessary.





# HOW TO USE THE SEQUENCER

This section is a step by step explanation of how to create a song using the SY77's built-in sequencer. By using the sequencer in conjunction with Multi mode, you can create songs of up to 16 independent parts.

<b>Contents of this section</b>	<b>page</b>
<b>How the sequencer controls the tone generator.....</b>	<b>34</b>
<b>Set up a multi .....</b>	<b>36</b>
<b>Create rhythm patterns .....</b>	<b>38</b>
<b>Place the patterns in the pattern track.....</b>	<b>40</b>
<b>Realtime recording .....</b>	<b>42</b>
<b>Punch-in recording .....</b>	<b>44</b>
<b>Song editing .....</b>	<b>46</b>
<b>Using a song edit job .....</b>	<b>48</b>
<b>Saving your sequence to disk .....</b>	<b>50</b>

# How the sequencer controls the tone generator

Although the SY77's tone generator and sequencer are contained in the same unit, these two are independent. When the tone generator is in Multi mode, each channel of the multi can be played by a different track of musical data from the sequencer.

## The tone generator and sequencer are independent

The SY77 can be divided into two sections; the tone generator that produce sound, and the sequencer that records and plays back data such as notes and controller movements to control sound. The sequencer is completely independent of the tone generator, and has its own set of control buttons. This allows you to start or stop, record or playback at any time even while editing a voice or multi. It is especially helpful to edit a voice while it is being played by a sequencer pattern, or to make adjustments to the volume balances or pan settings of a multi while listening to the song playback.

The sequencer will record data from the SY77's keyboard and also from MIDI IN, and will playback data to the SY77's tone generator and also transmit it from MIDI OUT. The tone generator will produce sound in response to data from the sequencer and also from MIDI IN.

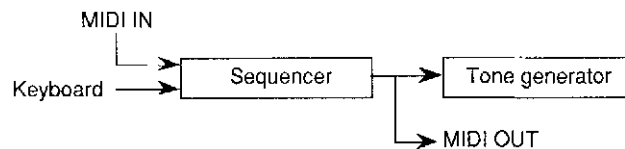

## How the sequencer controls the tone generator

Depending on whether the SONG or the PATTERN button was last pressed, the sequencer will record and playback data either in Song mode or in Pattern mode. Depending on whether the VOICE or the MULTI button was last pressed, the tone generator will produce sound either in Voice mode or in Multi mode. This means that the sequencer and tone generator can work together in four possible ways as shown in the following table.

Sequencer	Mode	SONG	SONG	PATTERN	PATTERN
	Transmits	16 channels	16 channels	1 channel	1 channel
		↓	↓	↓	↓
Tone generator	Mode	VOICE	MULTI	VOICE	MULTI
	Receives	1 channel	16 channels	1 channel	16 channels

As you can see from the above table, the greatest musical complexity is possible when the sequencer is used in Song mode to play the tone generator in Multi mode. However other combinations of sequencer and tone generator will be useful when creating sequences, patterns, or voices. For example it is often helpful to keep a sequencer Pattern playing while you edit a Drum Voice.

## **Fifteen tracks + pattern track + patterns = one song**

### **About this tutorial**

Each track 1–15 contains an independent musical performance; notes, pitch bends, controller movement, and program changes. Track 16 is a dedicated Pattern track. It contains pattern numbers and repeat marks. When playback comes to a pattern number, the specified pattern will be played.

In the following pages of this section, we will be explaining the entire process of creating a song; creating patterns and arranging them in the pattern track, recording other tracks, and editing. Finally we will save the completed song to disk. Our procedure will be as follows.

1. Create a Multi by selecting a voice for each of the 16 channels, and making settings for volume, pan, etc. for each channel.
2. Enter Pattern mode and create several rhythm patterns.
3. Enter Song mode and place these patterns in track 16 (the pattern track).
4. Record one or more tracks in realtime.
5. Punch-in on a section of the track to fix a mistake.
6. Use song edit mode to correct and insert individual data events.
7. Use a song edit job to transpose specified measures.
8. Save the completed sequence to disk.

#### **Note:**

*The output channel of the sequencer tracks can be changed if desired, allowing you to use two or more tracks to control a single channel of the multi. However to keep this tutorial simple, we will select normal voices (piano, bass, strings, etc.) for channels 1–15 of the multi and a drum voice for channel 16 of the multi. Tracks 1–15 of the sequencer will contain the music for the normal voices, and track 16 will contain the patterns to play the drum voice.*

# Set up a multi

When the SY77's tone generator is used in Multi mode, it will function as 16 independent synthesizers. This allows each track of the sequencer to play a different sound.

## Start with the initial multi

Since in this tutorial we will be creating a song with more than one track, we will use the SY77's tone generator in multi mode so that it will function as 16 independent synthesizers.

Press MULTI, then press EDIT. While holding SHIFT press F7 (15) to select the Initialize job.

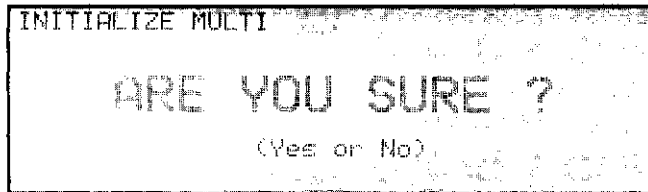

Press +1/YES. The display will show "Completed!". Press EXIT to return to the Multi Edit job directory.

## Select the voice for each channel of the multi

Press F1 (01) to get the following display (or JUMP #401).



Specify the voice that will be played by each channel 1-16 of the multi by moving the cursor and using the MEMORY, BANK, and the memory select buttons 1-16. It is not possible for an Internal multi to use Card voices, nor is it possible for a Card multi to use Internal voices.

In this example we will be assuming that you have selected the following voices for channels 1-3 and 16. Select voices as desired for the other channels of the multi.

Multi ch. no.	Voice no.	Voice name
1	P1-A01	GrandPiano
2	P1-A10	Wood Bass
3	P1-A11	ChamberStr
...		
16	P2-D15	Drum 1

Press EXIT to return to the Multi Edit job directory.

**Make effect settings for the multi**

Press F7 (07) to select 07:Effect from the Multi Edit job directory and then press F1 to select 01:Effect Mode Select (or JUMP to page #413). With the initial settings the effect mode will be off. Press +1/YES to select effect mode 1.

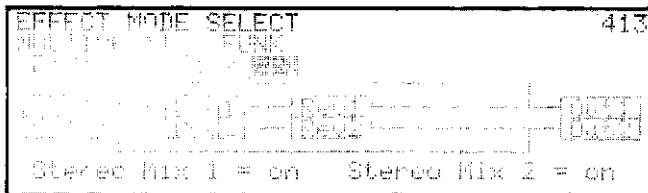

Press PAGE▷ three times to get the Reverb Effect 1 set display. With the initial settings the Reverb Effect 1 will be 00:Through. Press +1/YES to select 01:Rev.Hall.

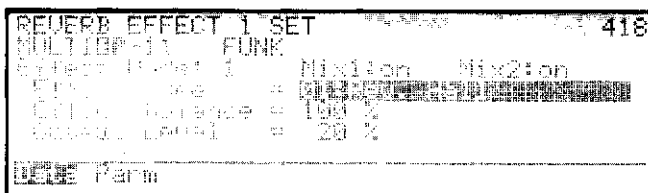

Press EXIT twice to return to the Multi Edit job directory.

**Other settings in multi edit mode**

To keep this example simple, we will leave the rest of the multi settings at their initial values. After completing this tutorial, you can read about *Multi edit* in the *Reference* section to learn more about a multi.

**Save the newly created multi**

From the Multi Edit job directory press EXIT. Since you have modified the data, the top line of the display will blink "Auto-store multi".

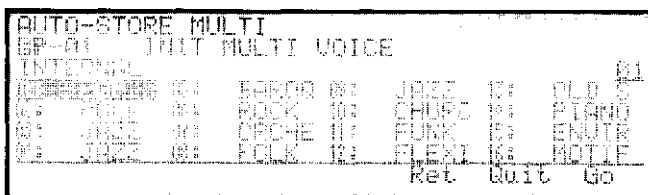

Press F8 (Go) and the multi will be stored into the currently selected multi memory. Or, if you want to keep the previous data of that multi, use the memory select buttons 1–16 to specify a different memory before you press F8 (Go).

The bottom line of the display will ask "Are you sure?". Press +1/YES and the newly edited multi will be stored, and you will return to multi play mode.

# Create rhythm patterns

Pattern mode allows you to create short phrases of 1–32 measures. These patterns can later be placed in track 16 (the pattern track) of song mode for use as rhythm parts or for phrases which appear frequently.

## Make settings for pattern recording

Press **PATTERN**, then press **RECORD** to make the **RECORD** LED light. Make the following settings.

<b>PATTERN01</b>		(we will record pattern 01)
<b>Time</b>	= 4/4	(the pattern will be in 4/4 time)
<b>Length</b>	= 01	(the pattern will be one measure long)
<b>Quantize</b>	= 1/16	(notes will be corrected to the nearest 1/16th)
<b>Receive Ch</b>	= kbd	(notes will be recorded from the SY77 keyboard)
<b>Click</b>	= rec	(the click will sound only while recording)
<b>Click Beat</b>	= 1/4	(the click will sound on each quarter note)
<b>Sync</b>	= internal	(the SY77 will keep time to its own internal clock)

Press **F1 (Real)** to select realtime recording. The LCD should now be as follows.

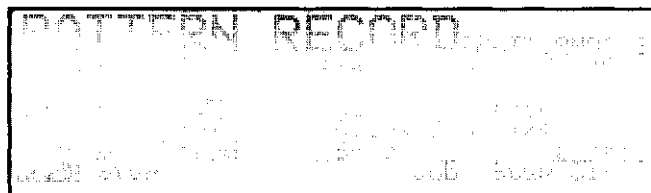

## Record the pattern

When you enter pattern recording mode, the keyboard will transmit the channel selected for track 16 (the pattern track) of the sequencer. With the default settings this will be channel 16, which will play the Drum 1 voice we selected for channel 16 of the multi.

Before you begin recording, play the keyboard to locate the rhythm sounds you will be using. Our first pattern will be a simple rhythm backing of bass drum, snare, and hi-hat.

Press **RUN** and pattern recording will begin. Keep time to the click and play the bass drum part (the **C1** key) for one measure. The pattern will continue to repeat from beginning to end, and you can hear the bass drum pattern just recorded. Next play the snare notes (**C#2**), and finally play the hi-hat notes (**A2** and **B2**). Of course it is possible to record more than one note at a time, and as you become more skilled you may wish to do so. You can delete any given note from the pattern by pressing **SHIFT** while holding down the key of the unwanted note, and allowing the pattern to run through the section you wish to erase.

Press **STOP** and pattern recording will end. Notice that the upper right of the LCD now shows **PATTERN01w**. The “w” indicates that data has been written into the pattern.

## Record another pattern

For the second pattern we will record a fill-in with toms (**E1**, **F1**, **F#1**, **G1**) and crash cymbal (**C3**). Press **RECORD** to make the **RECORD** LED light, and move the cursor to the upper right and select **PATTERN02**. Notice that there is no “w” after the pattern number, since no data has been written into this pattern.

Press **RUN** and pattern recording will begin. Now you can record an appropriate fill-in pattern.

Press **STOP** and pattern recording will end.



# Place the patterns in the pattern track

Editing functions in song mode allow you to place previously created patterns into track 16 (the pattern track) for use as rhythm parts or for phrases which appear frequently.

## Chain Pattern mode

Before recording the other tracks, we will place the previously recorded patterns into track 16. Press SONG and then EDIT to enter song edit mode. Press 16 to select track 16 (the pattern track) for editing. While editing track 16 you will be in Chain Pattern mode.

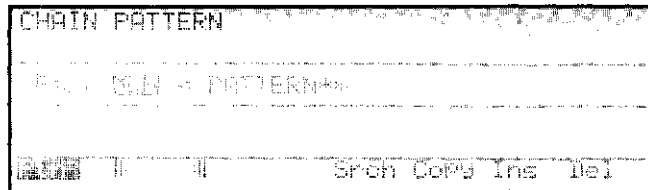

## Using repeat marks

In this example, we will chain patterns so that three measures of the basic rhythm are followed by a fill-in, and make this four-measure chain repeat for eight times. Although it is possible to input all 32 parts (the four-measure chain x 8 times), it is more efficient to use repeat marks. To do this we will input data for each part as follows.

Part 001 : ll:  
Part 002 : 01  
Part 003 : 01  
Part 004 : 01  
Part 005 : 02  
Part 006 : :ll x 7

## Input the data for each part

Move the cursor to the right and press F2 (ll:) to enter a repeat begin mark for part 001, then press ENTER. The "Part" display will advance to 002. Select pattern "01w" for Part 002, and press ENTER.

In the same way input pattern 01 for parts 003 and 004, and pattern 02 for part 005.

For part 006, press F3 (:ll). Use -1 +1 to specify "x 7" so that the range of parts between the begin and end repeat marks repeat 7 times. Be sure to press ENTER to enter each part.

When you are finished editing the chain of patterns, press EXIT to return to Song Play mode. Press RUN and you will hear the newly edited chain of patterns.





# Realtime recording

In realtime recording the notes you play will be recorded in the exact timing with which you play them.

## Make settings for realtime recording

From the song play display press RECORD to enter song record mode and press F1 (Real) to select realtime recording.

If you have been following along with the previous pages of this section, the various settings will be the same as you specified in Pattern recording. However for realtime recording a track, you may wish to turn off quantization. Move the cursor to Quantize and press -1 several times to select "off".

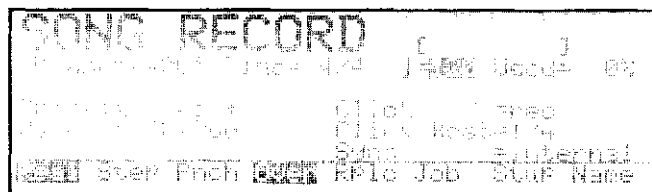

## Record the first track

In song mode, the memory buttons 1–15 select the track to record. For this example, press the select button 1 to make the track 1 LED light red. With the default settings track 1 of the sequencer will transmit its data on channel 1. Since in this example you have selected a piano voice for channel 1 of the multi, you will hear the piano voice when you play the keyboard.

To begin recording press RUN. The RUN LED will blink and after a two-measure countdown recording will begin. Play the keyboard. As you record, the Measure display will advance to show the number of the measure currently being recorded.

When you are finished recording the track, press STOP. You will return to the song play display.

Press  $\leftarrow$  to return to measure 1, and press RUN to hear the track you just recorded. Press STOP to stop playback.

## Record additional tracks

To record additional tracks,

- press  $\leftarrow$  to return to measure 1
- press RECORD
- press a memory button 2–15 to select another track (LED lights red)
- and press RUN to record the track while listening to previously recorded parts. Press STOP to stop playback.

In this way, record all the tracks of the song. As you record each track you will hear the previously recorded tracks playback. The multi we created in the beginning of this example uses the following voices.

Multi ch. no.	Voice no.	Voice name
1	P1-A01	GrandPiano
2	P1-A10	Wood Bass
3	P1-A11	ChamberStr
...		
16	P2-D15	Drum 1

With the initial settings of the sequencer, tracks 1–16 will transmit their data on channels 1–16 (this can be changed) and be received by channels 1–16 (this cannot be changed) of the multi. If you are following this example, record the piano on track 1, bass on track 2, and strings on track 3.

# Punch-in recording

In punch-in recording the notes you play will be recorded in the exact timing with with you play them, but only over the measures you specify. This is useful when you wish to re-record only a specific section of a previously recorded track.

## When to use punch-in recording

Suppose that while recording track 2, you made a few mistakes in measures 15 and 16. While it is possible to re-record the entire track, it is more efficient to use punch-in recording to re-record only the measures necessary. There is no purpose in using punch-in recording on a track which contains no data.

Punch-in recording allows you to specify the measure at which recording will begin and the measure at which recording will end. Measures before and after this area will not be affected.

The following diagram shows the result of punch-in recording.

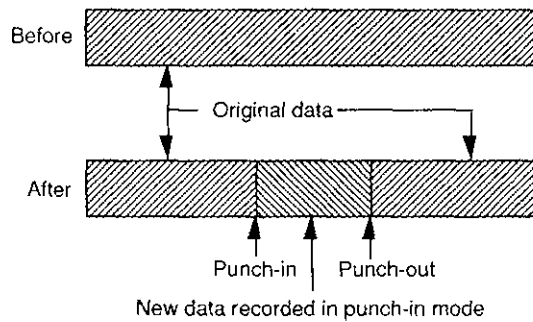

## Specify the area of measures to re-record

In this example we will assume that you wish to re-record measures 15 and 16 of track 2.

1. Press SONG to enter song play mode.
2. Press RECORD to enter song record mode.
3. Press F3 (Pnch) to select punch-in recording.
4. Press the memory select button 2 to select track 2 for recording.
5. Specify "From Meas =015" and "To Meas =016".

```
SONG RECORD [ ]
Song: 001 Time= 4:04 [F12] Used= 0%
Tempo: 120 To Phos =000
Click = Rec
Click Beat=1/4
Sync = Internal
Real Step [ ] Over [ ] Job Step Name
```

## Re-record the specified measures

Move the cursor to Measure and select a point a few measures before 015. This will give you a chance to get the feel of the section you are going to re-record.

To begin recording press RUN. The RUN LED will blink on the beats. Play along with the original. When measure 15 is reached, the original recording on track 2 will disappear and your new playing will be recorded. When measure 16 ends, the original recording of track 2 will reappear, but playback will continue.

Press STOP and you will return to the song play display.





Press ENTER to insert the program change data. In the same way, insert another program change number 1 at the beginning of the track (measure 001-01-00/96) so that the original voice P1-A01 GrandPiano will be selected when the track begins.

Press F2 (Chng) to return to data change mode. Move the dial to scroll through the data and notice that the program change data has been inserted into the track.

When you return to song play mode and playback this track, the piano voice originally selected for this track will change to voice P1-A03 DynoE.Pno when playback reaches measure 17.

## Use Graph mode to view notes

Song edit Graph mode allows you to view notes as dots on a keyboard diagram. Press F7 (Grph) to enter Graph mode. The following display will appear.

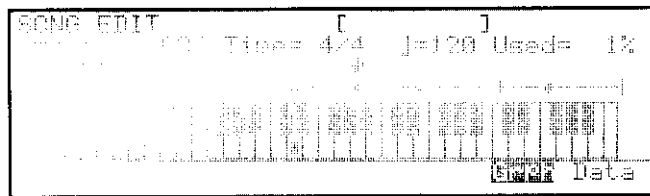

A horizontal line will be displayed with dots indicating the position of note data in the measure. To select the measure, place the cursor on the measure number and use the dial or -1 +1 keys. To move through the data note by note, place the cursor on the same row as the downward pointing arrow and use the dial or -1 +1 keys. As you move, the keyboard diagram in the lower part of the LCD will indicate the notes at the currently selected 32nd note area. The notes will also be played as you come to them.

Graph mode displays only note data, and does not allow you to modify the data.

Press EXIT to leave song edit mode and return to song play mode. Playback the song to check that the F3 note has been corrected to F#3, and that the voice changes to number 3 at measure 17.

# Using a song edit job

Song edit jobs allow you to make overall changes in specified measures of a track, and to copy, erase, delete, insert, or apply other operations to entire measures

## When to use a song edit job

As explained in the previous section, song edit mode allows you to modify, insert, or delete individual events of tracks 1–15. This gives you very precise control over individual data events, but it is often useful to use a Song Edit Job to make overall changes that apply to all the data in one or more entire measures.

Sixteen different song edit jobs are provided, allowing you to modify the data of specified measures in various ways. You can also copy, erase, delete, insert, etc. entire measures. In this example, we will use a song edit job to transpose the notes in measures 17–32 of track 3 an octave up.

## Select the song edit job

From the song play display, press F6 (Job) to get the Song Edit Job display.

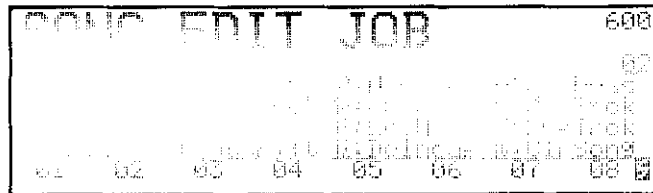

Press F5 (05) to select the 05:Transps (transpose) job.

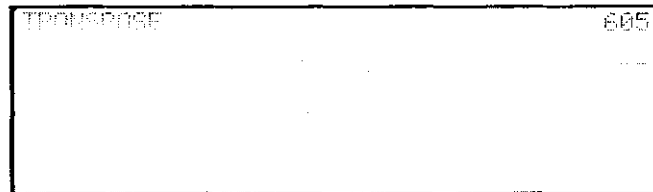

## Set parameters and execute the job

Now we will specify the track to be affected, the area of measures, and the amount by which the data will be transposed.

1. Press memory select button 3 to select track 3.
2. Set the Top Measure =017 and the Last Measure =032.
3. Set the Interval =+12 (one octave up).

After setting the parameters, press ENTER. The bottom line of the LCD will ask "Are you sure?". Press +1/YES and the job will be executed.

Press EXIT twice to leave song edit mode and return to song play mode.

Press RUN to playback the song, and notice that measures 17–32 of track 3 play an octave higher than measures 1–16.





# Saving your sequence to disk

Since the sequencer memory can contain only one song, you will need to save the song to disk before creating another song. It is also a good idea to periodically save your work so as not to accidentally lose important data.

## Enter disk utility mode

Press **UTILITY** to enter utility mode, make sure that a floppy disk of the correct type (3.5" 2DD) is inserted into the disk drive, and press **F4 (Disk)** to select disk utility mode.

```
UTILITY 818
-----
01
02
03
04
05
06
07
08
09
10
11
12
13
14
15
16
17
18
19
20
21
22
23
24
25
26
27
28
29
30
31
32
33
34
35
36
37
38
39
40
41
42
43
44
45
46
47
48
49
50
51
52
53
54
55
56
57
58
59
60
61
62
63
64
65
66
67
68
69
70
71
72
73
74
75
76
77
78
79
80
81
82
83
84
85
86
87
88
89
90
91
92
93
94
95
96
97
98
99
100
101
102
103
104
105
106
107
108
109
110
111
112
113
114
115
116
117
118
119
120
121
122
123
124
125
126
127
128
129
130
131
132
133
134
135
136
137
138
139
140
141
142
143
144
145
146
147
148
149
150
151
152
153
154
155
156
157
158
159
160
161
162
163
164
165
166
167
168
169
170
171
172
173
174
175
176
177
178
179
180
181
182
183
184
185
186
187
188
189
190
191
192
193
194
195
196
197
198
199
200
201
202
203
204
205
206
207
208
209
210
211
212
213
214
215
216
217
218
219
220
221
222
223
224
225
226
227
228
229
230
231
232
233
234
235
236
237
238
239
240
241
242
243
244
245
246
247
248
249
250
251
252
253
254
255
256
257
258
259
260
261
262
263
264
265
266
267
268
269
270
271
272
273
274
275
276
277
278
279
280
281
282
283
284
285
286
287
288
289
290
291
292
293
294
295
296
297
298
299
300
301
302
303
304
305
306
307
308
309
310
311
312
313
314
315
316
317
318
319
320
321
322
323
324
325
326
327
328
329
330
331
332
333
334
335
336
337
338
339
340
341
342
343
344
345
346
347
348
349
350
351
352
353
354
355
356
357
358
359
360
361
362
363
364
365
366
367
368
369
370
371
372
373
374
375
376
377
378
379
380
381
382
383
384
385
386
387
388
389
390
391
392
393
394
395
396
397
398
399
400
401
402
403
404
405
406
407
408
409
410
411
412
413
414
415
416
417
418
419
420
421
422
423
424
425
426
427
428
429
430
431
432
433
434
435
436
437
438
439
440
441
442
443
444
445
446
447
448
449
450
451
452
453
454
455
456
457
458
459
460
461
462
463
464
465
466
467
468
469
470
471
472
473
474
475
476
477
478
479
480
481
482
483
484
485
486
487
488
489
490
491
492
493
494
495
496
497
498
499
500
501
502
503
504
505
506
507
508
509
510
511
512
513
514
515
516
517
518
519
520
521
522
523
524
525
526
527
528
529
530
531
532
533
534
535
536
537
538
539
540
541
542
543
544
545
546
547
548
549
550
551
552
553
554
555
556
557
558
559
560
561
562
563
564
565
566
567
568
569
570
571
572
573
574
575
576
577
578
579
580
581
582
583
584
585
586
587
588
589
590
591
592
593
594
595
596
597
598
599
600
601
602
603
604
605
606
607
608
609
610
611
612
613
614
615
616
617
618
619
620
621
622
623
624
625
626
627
628
629
630
631
632
633
634
635
636
637
638
639
640
641
642
643
644
645
646
647
648
649
650
651
652
653
654
655
656
657
658
659
660
661
662
663
664
665
666
667
668
669
670
671
672
673
674
675
676
677
678
679
680
681
682
683
684
685
686
687
688
689
690
691
692
693
694
695
696
697
698
699
700
701
702
703
704
705
706
707
708
709
710
711
712
713
714
715
716
717
718
719
720
721
722
723
724
725
726
727
728
729
730
731
732
733
734
735
736
737
738
739
740
741
742
743
744
745
746
747
748
749
750
751
752
753
754
755
756
757
758
759
760
761
762
763
764
765
766
767
768
769
770
771
772
773
774
775
776
777
778
779
780
781
782
783
784
785
786
787
788
789
790
791
792
793
794
795
796
797
798
799
800
801
802
803
804
805
806
807
808
809
810
811
812
813
814
815
816
817
818
819
820
821
822
823
824
825
826
827
828
829
830
831
832
833
834
835
836
837
838
839
840
841
842
843
844
845
846
847
848
849
850
851
852
853
854
855
856
857
858
859
860
861
862
863
864
865
866
867
868
869
870
871
872
873
874
875
876
877
878
879
880
881
882
883
884
885
886
887
888
889
890
891
892
893
894
895
896
897
898
899
900
901
902
903
904
905
906
907
908
909
910
911
912
913
914
915
916
917
918
919
920
921
922
923
924
925
926
927
928
929
930
931
932
933
934
935
936
937
938
939
940
941
942
943
944
945
946
947
948
949
950
951
952
953
954
955
956
957
958
959
960
961
962
963
964
965
966
967
968
969
970
971
972
973
974
975
976
977
978
979
980
981
982
983
984
985
986
987
988
989
990
991
992
993
994
995
996
997
998
999
1000
1001
1002
1003
1004
1005
1006
1007
1008
1009
1010
1011
1012
1013
1014
1015
1016
1017
1018
1019
1020
1021
1022
1023
1024
1025
1026
1027
1028
1029
1030
1031
1032
1033
1034
1035
1036
1037
1038
1039
1040
1041
1042
1043
1044
1045
1046
1047
1048
1049
1050
1051
1052
1053
1054
1055
1056
1057
1058
1059
1060
1061
1062
1063
1064
1065
1066
1067
1068
1069
1070
1071
1072
1073
1074
1075
1076
1077
1078
1079
1080
1081
1082
1083
1084
1085
1086
1087
1088
1089
1090
1091
1092
1093
1094
1095
1096
1097
1098
1099
1100
1101
1102
1103
1104
1105
1106
1107
1108
1109
1110
1111
1112
1113
1114
1115
1116
1117
1118
1119
1120
1121
1122
1123
1124
1125
1126
1127
1128
1129
1130
1131
1132
1133
1134
1135
1136
1137
1138
1139
1140
1141
1142
1143
1144
1145
1146
1147
1148
1149
1150
1151
1152
1153
1154
1155
1156
1157
1158
1159
1160
1161
1162
1163
1164
1165
1166
1167
1168
1169
1170
1171
1172
1173
1174
1175
1176
1177
1178
1179
1180
1181
1182
1183
1184
1185
1186
1187
1188
1189
1190
1191
1192
1193
1194
1195
1196
1197
1198
1199
1200
1201
1202
1203
1204
1205
1206
1207
1208
1209
1210
1211
1212
1213
1214
1215
1216
1217
1218
1219
1220
1221
1222
1223
1224
1225
1226
1227
1228
1229
1230
1231
1232
1233
1234
1235
1236
1237
1238
1239
1240
1241
1242
1243
1244
1245
1246
1247
1248
1249
1250
1251
1252
1253
1254
1255
1256
1257
1258
1259
1260
1261
1262
1263
1264
1265
1266
1267
1268
1269
1270
1271
1272
1273
1274
1275
1276
1277
1278
1279
1280
1281
1282
1283
1284
1285
1286
1287
1288
1289
1290
1291
1292
1293
1294
1295
1296
1297
1298
1299
1300
1301
1302
1303
1304
1305
1306
1307
1308
1309
1310
1311
1312
1313
1314
1315
1316
1317
1318
1319
1320
1321
1322
1323
1324
1325
1326
1327
1328
1329
1330
1331
1332
1333
1334
1335
1336
1337
1338
1339
1340
1341
1342
1343
1344
1345
1346
1347
1348
1349
1350
1351
1352
1353
1354
1355
1356
1357
1358
1359
1360
1361
1362
1363
1364
1365
1366
1367
1368
1369
1370
1371
1372
1373
1374
1375
1376
1377
1378
1379
1380
1381
1382
1383
1384
1385
1386
1387
1388
1389
1390
1391
1392
1393
1394
1395
1396
1397
1398
1399
1400
1401
1402
1403
1404
1405
1406
1407
1408
1409
1410
1411
1412
1413
1414
1415
1416
1417
1418
1419
1420
1421
1422
1423
1424
1425
1426
1427
1428
1429
1430
1431
1432
1433
1434
1435
1436
1437
1438
1439
1440
1441
1442
1443
1444
1445
1446
1447
1448
1449
1450
1451
1452
1453
1454
1455
1456
1457
1458
1459
1460
1461
1462
1463
1464
1465
1466
1467
1468
1469
1470
1471
1472
1473
1474
1475
1476
1477
1478
1479
1480
1481
1482
1483
1484
1485
1486
1487
1488
1489
1490
1491
1492
1493
1494
1495
1496
1497
1498
1499
1500
1501
1502
1503
1504
1505
1506
1507
1508
1509
1510
1511
1512
1513
1514
1515
1516
1517
1518
1519
1520
1521
1522
1523
1524
1525
1526
1527
1528
1529
1530
1531
1532
1533
1534
1535
1536
1537
1538
1539
1540
1541
1542
1543
1544
1545
1546
1547
1548
1549
1550
1551
1552
1553
1554
1555
1556
1557
1558
1559
1560
1561
1562
1563
1564
1565
1566
1567
1568
1569
1570
1571
1572
1573
1574
1575
1576
1577
1578
1579
1580
1581
1582
1583
1584
1585
1586
1587
1588
1589
1590
1591
1592
1593
1594
1595
1596
1597
1598
1599
1600
1601
1602
1603
1604
1605
1606
1607
1608
1609
1610
1611
1612
1613
1614
1615
1616
1617
1618
1619
1620
1621
1622
1623
1624
1625
1626
1627
1628
1629
1630
1631
1632
1633
1634
1635
1636
1637
1638
1639
1640
1641
1642
1643
1644
1645
1646
1647
1648
1649
1650
1651
1652
1653
1654
1655
1656
1657
1658
1659
1660
1661
1662
1663
1664
1665
1666
1667
1668
1669
1670
1671
1672
1673
1674
1675
1676
1677
1678
1679
1680
1681
1682
1683
1684
1685
1686
1687
1688
1689
1690
1691
1692
1693
1694
1695
1696
1697
1698
1699
1700
1701
1702
1703
1704
1705
1706
1707
1708
1709
1710
1711
1712
1713
1714
1715
1716
1717
1718
1719
1720
1721
1722
1723
1724
1725
1726
1727
1728
1729
1730
1731
1732
1733
1734
1735
1736
1737
1738
1739
1740
1741
1742
1743
1744
1745
1746
1747
1748
1749
1750
1751
1752
1753
1754
1755
1756
1757
1758
1759
1760
1761
1762
1763
1764
1765
1766
1767
1768
1769
1770
1771
1772
1773
1774
1775
1776
1777
1778
1779
1780
1781
1782
1783
1784
1785
1786
1787
1788
1789
1790
1791
1792
1793
1794
1795
1796
1797
1798
1799
1800
1801
1802
1803
1804
1805
1806
1807
1808
1809
1810
1811
1812
1813
1814
1815
1816
1817
1818
1819
1820
1821
1822
1823
1824
1825
1826
1827
1828
1829
1830
1831
1832
1833
1834
1835
1836
1837
1838
1839
1840
1841
1842
1843
1844
1845
1846
1847
1848
1849
1850
1851
1852
1853
1854
1855
1856
1857
1858
1859
1860
1861
1862
1863
1864
1865
1866
1867
1868
1869
1870
1871
1872
1873
1874
1875
1876
1877
1878
1879
1880
1881
1882
1883
1884
1885
1886
1887
1888
1889
1890
1891
1892
1893
1894
1895
1896
1897
1898
1899
1900
1901
1902
1903
1904
1905
1906
1907
1908
1909
1910
1911
1912
1913
1914
1915
1916
1917
1918
1919
1920
1921
1922
1923
1924
1925
1926
1927
1928
1929
1930
1931
1932
1933
1934
1935
1936
1937
1938
1939
1940
1941
1942
1943
1944
1945
1946
1947
1948
1949
1950
1951
1952
1953
1954
1955
1956
1957
1958
1959
1960
1961
1962
1963
1964
1965
1966
1967
1968
1969
1970
1971
1972
1973
1974
1975
1976
1977
1978
1979
1980
1981
1982
1983
1984
1985
1986
1987
1988
1989
1990
1991
1992
1993
1994
1995
1996
1997
1998
1999
2000
2001
2002
2003
2004
2005
2006
2007
2008
2009
2010
2011
2012
2013
2014
2015
2016
2017
2018
2019
2020
2021
2022
2023
2024
2025
2026
2027
2028
2029
2030
2031
2032
2033
2034
2035
2036
2037
2038
2039
2040
2041
2042
2043
2044
2045
2046
2047
2048
2049
2050
2051
2052
2053
2054
2055
2056
2057
2058
2059
2060
2061
2062
2063
2064
2065
2066
2067
2068
2069
2070
2071
2072
2073
2074
2075
2076
2077
2078
2079
2080
2081
2082
2083
2084
2085
2086
2087
2088
2089
2090
2091
2092
2093
2094
2095
2096
2097
2098
2099
2100
2101
2102
2103
2104
2105
2106
2107
2108
2109
2110
2111
2112
2113
2114
2115
2116
2117
2118
2119
2120
2121
2122
2123
2124
2125
2126
2127
2128
2129
2130
2131
2132
2133
2134
2135
2136
2137
2138
2139
2140
2141
2142
2143
2144
2145
2146
2147
2148
2149
2150
2151
2152
2153
2154
2155
2156
2157
2158
2159
2160
2161
2162
2163
2164
2165
2166
2167
2168
2169
2170
2171
2172
2173
2174
2175
2176
2177
2178
2179
2180
2181
2182
2183
2184
2185
2186
2187
2188
2189
2190
2191
2192
2193
2194
2195
2196
2197
2198
2199
2200
2201
2202
2203
2204
2205
2206
2207
2208
2209
2210
2211
2212
2213
2214
2215
2216
2217
2218
2219
2220
2221
2222
2223
2224
2225
2226
2227
2228
2229
2230
2231
2232
2233
2234
2235
2236
2237
2238
2239
2240
2241
2242
2243
2244
2245
2246
2247
2248
2249
2250
2251
2252
2253
2254
2255
2256
2257
2258
2259
2260
2261
2262
2263
2264
2265
2266
2267
2268
2269
2270
2271
2272
2273
2274
2275
2276
2277
2278
2279
2280
2281
2282
2283
2284
2285
2286
2287
2288
2289
2290
2291
2292
2293
2294
2295
2296
2297
2298
2299
2300
2301
2302
2303
2304
2305
2306
2307
2308
2309
2310
2311
2312
2313
2314
2315
2316
2317
2318
2319
2320
2321
2322
2323
2324
2325
2326
2327
2328
2329
2330
2331
2332
2333
2334
2335
2336
2337
2338
2339
2340
2341
2342
2343
2344
2345
2346
2347
2348
2349
2350
2351
2352
2353
2354
2355
2356
2357
2358
2359
2360
2361
2362
2363
2364
2365
2366
2367
2368
2369
2370
2371
2372
2373
2374
2375
2376
2377
2378
2379
2380
2381
2382
2383
2384
2385
2386
2387
2388
2389
2390
2391
2392
2393
2394
2395
2396
2397
2398
2399
2400
2401
2402
2403
2404
2405
2406
2407
2408
2409
2410
2411
2412
2413
2414
2415
2416
2417
2418
2419
2420
2421
2422
2423
2424
2425
2426
2427
2428
2429
2430
2431
2432
2433
2434
2435
2436
2437
2438
2439
2440
2441
2442
2443
2444
2445
2446
2447
2448
2449
2450
2451
2452
2453
2454
2455
2456
2457
2458
2459
2460
2461
2462
2463
2464
2465
2466
2467
2468
2469
2470
2471
2472
2473
2474
2475
2476
2477
2478
2479
2480
2481
2482
2483
2484
2485
2486
2487
2488
2489
2490
2491
2492
2493
2494
2495
2496
2497
2498
2499
2500
2501
2502
2503
2504
2505
2506
2507
2508
2509
2510
2511
2512
2513
2514
2515
2516
2517
2518
2519
2520
2521
2522
2523
2524
2525
2526
2527
2528
2529
2530
2531
2532
2533
2534
2535
2536
2537
2538
2539
2540
2541
2542
2543
2544
2545
2546
2547
2548
2549
2550
2551
2552
2553
2554
2555
2556
2557
2558
2559
2560
2561
2562
2563
2564
2565
2566
2567
2568
2569
2570
2571
2572
2573
2574
2575
2576
2577
2578
2579
2580
2581
2582
2583
2584
2585
2586
2587
2588
2589
2590
2591
2592
2593
2594
2595
2596
2597
2598
2599
2600
2601
2602
2603
2604
2605
2606
2607
2608
2609
2610
2611
2612
2613
2614
2615
2616
2617
2618
2619
2620
2621
2622
2623
2624
2625
2626
2627
2628
2629
2630
2631
2632
2633
2634
2635
2636
2637
2638
2639
26
```

Select 03:Sequencer All, and press ENTER to get the following display.

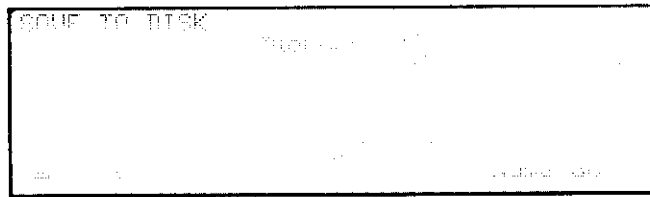

If files containing *Sequencer All* data have already been saved on this disk, the filenames will be displayed. Move the cursor in this area to select a disk file to which you want to save your newly recorded song. For this example, select any filename of “- NEW -”.

### Specify a filename

Press F7 (Name). This allows you to give an eight character name to the file.

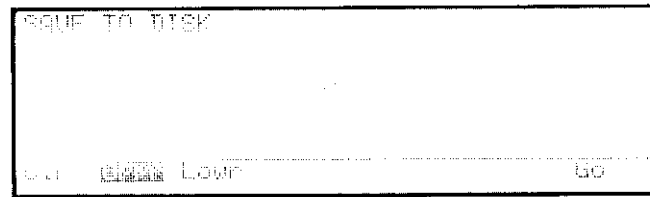

Press F1 (Clr) to clear the currently entered name. Then specify a filename, using the numeric keypad to enter characters. Each time you press one of the numeric keys, the LCD will cycle through the numeral printed on the numeric key and the three alphabetical characters printed below it. Press F2 (Uppr) to switch to upper-case characters. Press F3 (Lowr) to switch to lower-case characters.

### Save the data to disk

After you have entered a name for the disk file press F8 (Go). The bottom line of the display will ask “Are you sure ?” If you are sure that you want to save the data, press YES and the data will be saved to the specified disk file. Press any mode select button to leave this job.



# HOW TO EDIT A VOICE

This section explains how to edit an existing voice or create a new voice from scratch. Although it is possible to enjoy the SY77 just by playing preset voices, we suggest that you take some time to learn how to edit your own voices. It will take a bit of practice to create the sounds you want, but as you become more experienced you will find that creating voices is enjoyable and rewarding.

<b>Contents of this section</b>	<b>page</b>
<b>What is a voice</b> .....	<b>54</b>
<b>What is an AWM element</b> .....	<b>56</b>
<b>The basics of FM synthesis</b> .....	<b>58</b>
<b>What is an AFM element</b> .....	<b>60</b>
<b>The process of voice editing</b> .....	<b>62</b>
<b>How voice edit mode is organized</b> .....	<b>64</b>
<b>Simple editing: reverb (Effect)</b> .....	<b>66</b>
<b>Simple editing: tone (Filter)</b> .....	<b>68</b>
<b>Simple editing: vibrato (LFO)</b> .....	<b>70</b>
<b>Simple editing: using a controller</b> .....	<b>72</b>
<b>Simple editing: attack (EG)</b> .....	<b>74</b>
<b>How to name and store your new voice</b> .....	<b>76</b>
<b>How to edit a drum voice</b> .....	<b>78</b>

# What is a Voice

Each Normal voice consists of settings for one two or four AFM or AWM elements (Element data) and settings which affect the entire voice (Common data). Each Drum voice consists of a different AWM sampled sound for each of the SY77's 61 keys.

**The Voice Mode determines the number of elements**

The SY77 contains a 16 note AFM tone generator and a 16 note AWM tone generator. The Voice Mode setting determines how these tone generators are used to create a Voice, and how many elements are used for each note you play. Each voice uses one of these eleven voice modes.

Mode	Element	E1	E2	E3	E4
01	1AFM mono	AFM	—	—	—
02	2AFM mono	AFM	AFM	—	—
03	4AFM mono	AFM	AFM	AFM	AFM
04	1AFM poly	AFM	—	—	—
05	2AFM poly	AFM	AFM	—	—
06	1AWM poly	AWM	—	—	—
07	2AWM poly	AWM	AWM	—	—
08	4AWM poly	AWM	AWM	AWM	AWM
09	1AFM & 1AWM poly	AFM	AWM	—	—
10	2AFM & 2AWM poly	AFM	AFM	AWM	AWM
11	Drum Set	61 AWM waves			

**A normal voice uses one two or four elements**

Voices created using modes 1–10 consist of Common data that affects all elements, and Element data for one two or four elements.

Common data includes a complete set of Effect data for the four DSP units, Controller data such as pitch bend and aftertouch assignments, and Other data such as microtuning table selection, random pitch fluctuation, and portamento settings. Common data also contains settings such as element volume level, detune, note shift, note limit, and velocity limit for each element.

Element data includes AFM or AWM data for one two or four AFM or AWM elements. The voice mode will determine whether each element uses AFM tone generation or AWM tone generation. Details of AFM and AWM element data are covered separately in following sections.

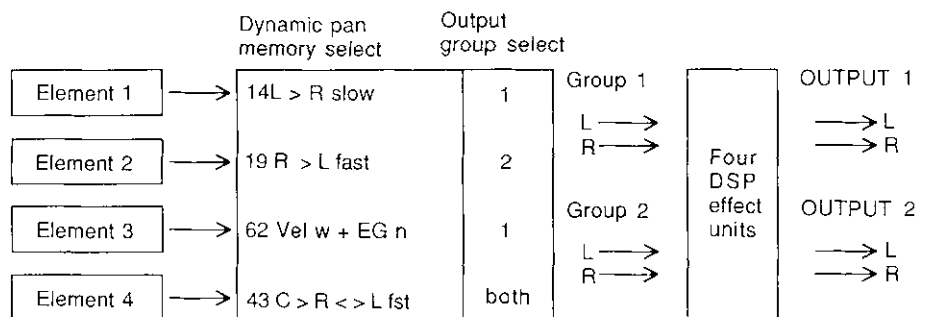

**A drum voice uses 61 AWM samples**

Voices created using mode 11 will have a different AWM sample assigned to each of the 61 keys (C1–C6) of the SY77. Each key also has independent settings for volume, tuning, note shift, pan, etc.

This type of voice is most often used to arrange drums and percussion sounds across the keyboard so that each key will produce a different percussive sound. For example a bass drum might be assigned to C3, a snare to C#3, and a cymbal to D3. Drum voices may be played from the keyboard in real time or recorded from the keyboard into a sequencer track. Details of how to edit drum voices are given at the end of this section.

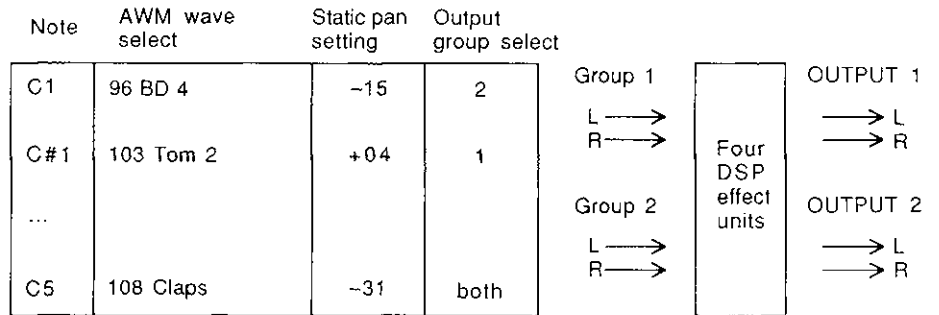

# What is an AWM element

An AWM element consists of four main blocks. The Waveform block plays back a sampled sound and determines the pitch, the Filter block modifies the tone, the Amplifier block modifies the volume, and the Pan block moves the sound between left and right outputs. Each block can be controlled in a variety of ways.

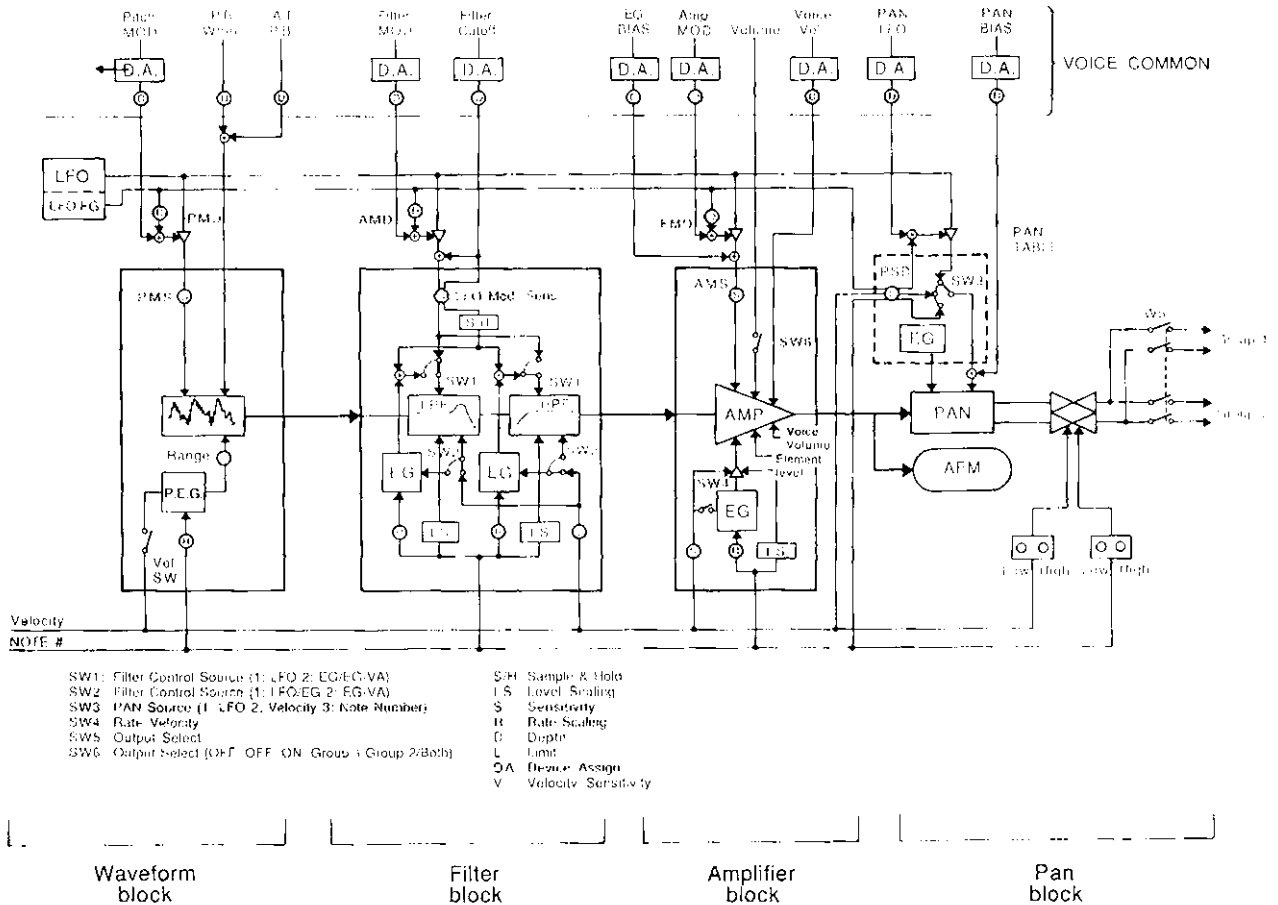

The above diagram shows how the various blocks in an AWM element are related, and how they can be controlled.

## Many different ways to control sound

All interesting sounds are constantly changing. For instruments such as piano, the tone and volume of each note changes in a predictable way over time. For other instruments such as violin, the volume, tone, or pitch can be continuously and freely modified by the musician. The SY77 provides several ways to control various aspects of the sound.

- **Envelope Generator (EG):** An EG produces a fixed pattern of change over time. For example to simulate the attack and decay of a piano, you would set the volume EG to be loud when the note is first played and then gradually diminish in volume.



- **Note Number:** The number of the note which is played can be used to affect various aspects of the sound. For example, high notes can be made to decay more rapidly than low notes. Or, low notes can be made to change in pitch, tone, or volume more than high notes.
- **Key Velocity:** The velocity (speed) with which you play each key can affect various aspects of the sound. For example, strongly and softly played notes can differ in pitch, tone, or volume.
- **Low Frequency Oscillator (LFO):** The LFO produces various patterns of cyclical change. Vibrato is the result when the LFO is applied to the waveform block; wah-wah when applied to the filter block; and tremolo when applied to the amplitude block.
- **Controllers:** Controllers such as the pitch and modulation wheels, aftertouch, and optional foot controllers can be used to control the sound in various ways. Some controllers such as the pitch bend wheel can directly determine the pitch. Other aspects of the sound can be controlled by the controller you assign. For example you might assign Aftertouch so that the amount of vibrato (LFO modulation to the Waveform block) is increased as you press down on the keyboard.

**The waveform block determines the pitch and basic tone**

The basic sound of each AWM element is produced by a waveform (a digitally sampled sound). The SY77 contains 112 different waveforms in internal ROM, and an optional waveform card can be inserted into the WAVEFORM slot to provide additional waveforms.

The waveform block can be controlled in various ways to modify the *pitch* of the sound. The pitch EG can be used to give each note a fixed pattern of pitch change, and this pitch change can also be affected by the note number or by key velocity. Vibrato (pitch modulation) can be created using the LFO, and the amount of vibrato can be regulated by a controller. The pitch can be controlled directly using the pitch bend wheel and/or aftertouch.

**The filter block modifies the tone**

The filter block can be controlled in various ways to modify the *tone* of the sound. Each note can be given a fixed pattern of tonal change by using the filter EG, and this can be also affected by the note number or key velocity. Wah-wah (filter modulation) can be created using the LFO, and wah-wah depth can be regulated by a controller. The tone can also be directly affected by a controller.

**The amplifier block modifies the volume**

The amplifier block can be controlled in various ways to control the *volume* of the sound. Each note can be given a fixed pattern of volume change by using the amplifier EG, and this can also be affected by the note number or key velocity. Tremolo (volume modulation) can be created using the LFO, and tremolo depth can be regulated by a controller. The volume can also be directly affected by a controller.

**The pan block moves the sound**

The pan block can be controlled in various ways to move the sound between left and right outputs. Each note can be given a fixed pattern of panning by using the pan EG, and this panning can be further affected by either note number, key velocity, or LFO.

# The basics of FM synthesis

FM synthesis is a patented Yamaha method for using Frequency Modulation (FM) to produce complex waveforms that can be controlled in musically useful ways.

## Interesting sounds have complex waveforms

The sounds produced by most musical instruments have a very complex waveform, which is constantly changing. We hear these complex waveforms as “interesting” or “acoustic-sounding”.

Electronic instruments use an oscillator to produce a waveform. Unfortunately, electronic oscillators are best at producing simple and repetitive waveforms. These waveforms sound “artificial” or “electronic”, and are not very interesting to listen to. A major concern of electronic musical instrument design is to find a simple way to electronically produce a complex waveform and be able to control it.



Complex waveform  
= interesting sound

Simple waveform  
= boring sound

## FM is a simple way to make a complex waveform

The advantage of FM synthesis is that waveforms with very complicated harmonic structure can be simply and economically created, and controlled in many different musically useful ways. In FM synthesis, one waveform is used to modulate another waveform. Even if the two original waveforms are simple, the result can be a complex and interesting sound.

In the following diagram, the upper oscillator is called the Modulator and the lower oscillator is called the Carrier. The complexity or brightness of the resulting waveform that we hear will depend on the output level of the Modulator; i.e., as we increase the modulation, the complexity or brightness will increase. Increasing the output level of the Carrier will simply increase the volume.

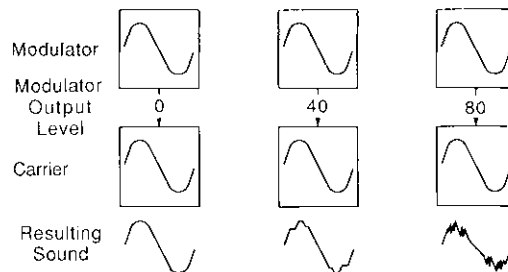

## Interesting sounds change over time

Many instruments have a characteristic pattern with which the sound changes as time goes by. This “shape in time” is called the Envelope. The following diagram shows how a piano envelope differs from an organ envelope. A piano begins loud and then gradually diminishes in volume and tonal complexity. An organ however maintains the same volume and tone as long as the key is pressed.

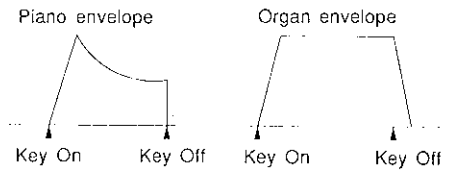

In synthesizers, a device called an Envelope Generator (EG) is used to produce a “shape in time” which can be used to control various aspects of the sound.

In Yamaha FM synthesizers, each oscillator has its own Envelope Generator (EG) to vary its output level over time. This package of oscillator and EG is called an Operator.

The FM tone generator of the SY77 uses six operators to produce sounds. These six operators can be arranged in 45 different basic Algorithms (patterns or combinations). Each operator acts either as a modulator or carrier depending on its *location* in the algorithm. Only operators that appear at the *bottom* of an algorithm are *carriers*.

For example algorithm 42 uses the six operators as three separate FM pairs; operators 2, 4, and 6 (the modulators) are modulating operators 1, 3, and 5 (the carriers). On the other hand, algorithm 6 has only one carrier; operators 4, 5, and 6 are all modulating operator 3, which is modulating operator 2, which is modulating operator 1.

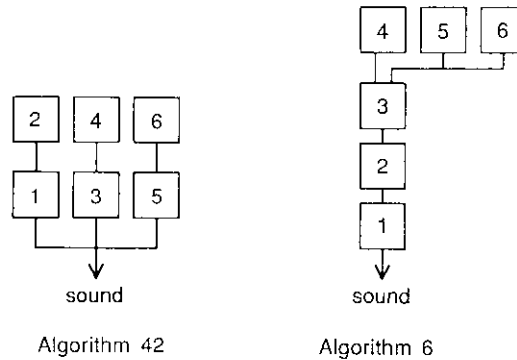

**An algorithm is an arrangement of six operators**

**How to change the tone of an FM sound**

We have learned that the output level of a modulator operator determines how complex or bright the resulting sound will be. This means that changing the output level of a modulator will affect the tone. The output of the carrier operator is what we actually hear, so changing the output level of a carrier will affect the volume.

Before you begin editing an FM sound, check the algorithm to see how the operators are arranged. Notice which operators are acting as carriers and which are acting as modulators. Then you can adjust the output levels of the various operators to modify the tone or volume.

Each operator has its own EG to vary the operator output level over time. Adjusting the EG of a modulator will modify how the tone will change over time. Adjusting the EG of a carrier will modify how volume will change over time.

# What is an AFM element

An AFM element consists of four main blocks. The FM block uses six operators to create a complex sound and determines the pitch and basic tone, the Filter block modifies the tone, the Amplifier block modifies the volume, and the Pan block moves the sound between left and right outputs. Each block can be controlled in a variety of ways.

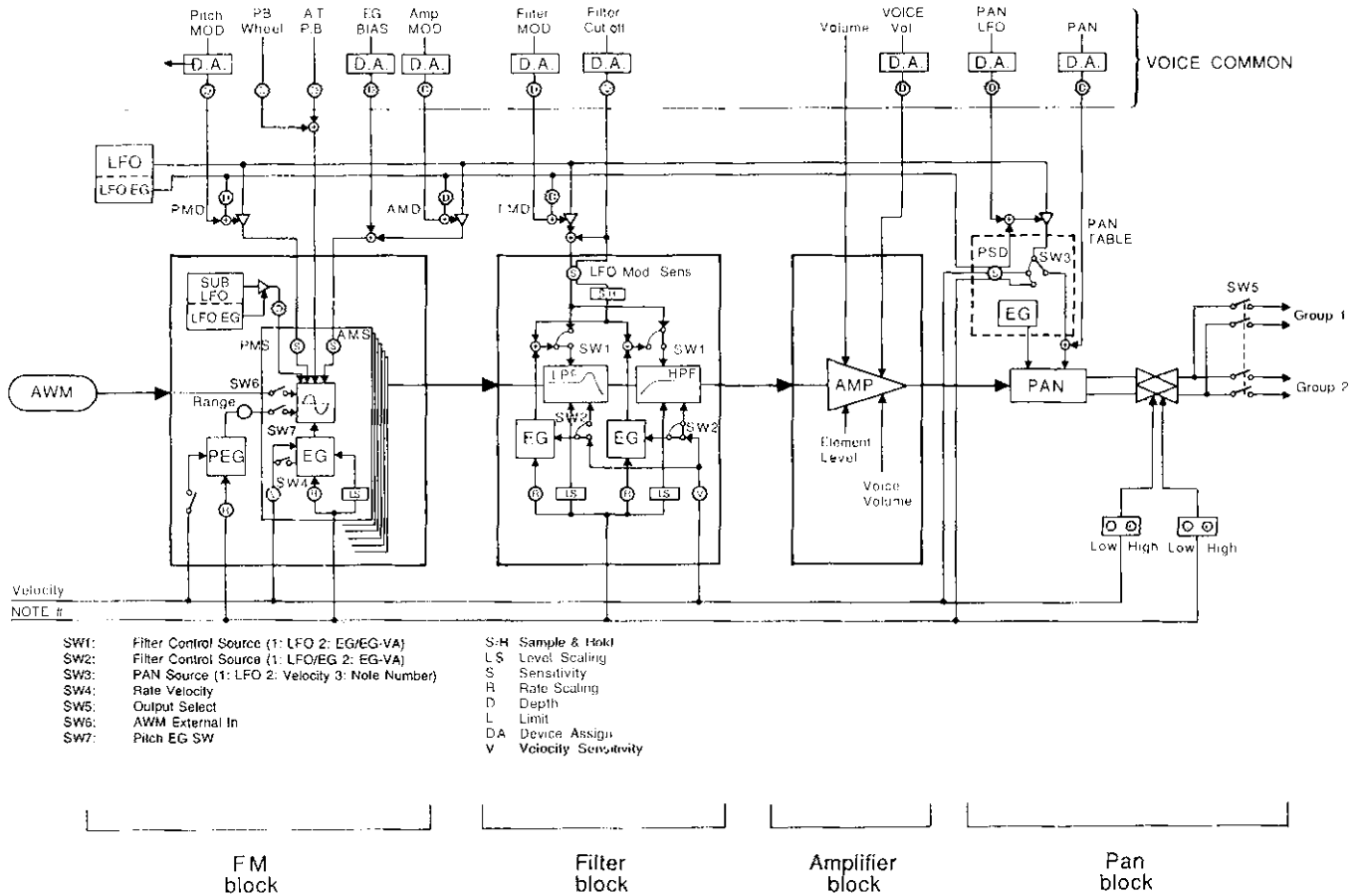

The above diagram shows how the various blocks in an AFM element are related, and how they can be controlled.

## Many different ways to control sound

As explained in the previous section “What is an AWM element”, an AFM element can be controlled in various ways using EG, note number, key velocity, LFO, and controllers.

## The FM block determines pitch, tone, and volume

The basic sound of each AFM element is produced by six FM operators arranged in an algorithm. The FM block can be controlled in various ways to modify the *pitch*, *tone*, and *volume* of the sound.

- EGs of the six operators determine how the volume and tone will change over time. Each operator EG can also be affected by the note number or key velocity.

- Pitch EG determines how each note will change in pitch over time. This pitch change can also be affected by the note number or by key velocity.
- LFO signal can be used to create vibrato (by modulating operator pitch) or tremolo (by modulating the output level of a carrier operator) or wah-wah (by modulating the output level of a modulator operator). The amount of pitch modulation or amplitude modulation from the main LFO can be regulated by a controller. In addition, the FM block of an AFM element contains a Sub LFO that can be used to modulate the pitch independently of the main LFO.
- The pitch of all operators can be controlled directly using the pitch bend wheel and/or aftertouch.
- As indicated by the “AWM” in the oval at the far left of the diagram, an AWM digital sample can be used to modulate an FM operator. This is one of the most significant features of the SY77’s tone generation system.

**The filter block modifies the tone**

The filter block can be controlled in various ways to modify the *tone* of the sound. Each note can be given a fixed pattern of tonal change by using the filter EG, and this can be also affected by the note number or key velocity. Wah-wah (filter modulation) can be created using the LFO, and wah-wah depth can be regulated by a controller. The tone can also be directly affected by a controller.

The filter blocks of AFM and AWM elements are identical.

**The amplifier block modifies the volume**

The amplifier block can be controlled directly by an assigned controller. Since the change in volume over time of an AFM element is determined by the EGs of carrier operators in the FM block, the amplifier block of an AFM element does not have its own EG.

**The pan block moves the sound**

The pan block can be controlled in various ways to move the sound between left and right outputs. Each note can be given a fixed pattern of panning by using the pan EG, and this panning can be further affected by either note number, key velocity, or LFO.

The pan blocks of AFM and AWM elements are identical.

# The process of voice editing

Editing a voice is a three-step process; select a voice, modify parameters as necessary, and store the edited voice. If you do not store the voice after editing it, the original voice will reappear and your edits will be lost.

## 1. Select the voice to edit

The first step in the voice editing process is to select the voice you wish to edit. Although it is possible to create a voice starting with the initialized data (a voice where all parameters are set to zero or some basic value), it is usually more efficient to start with a voice that is similar to what you want, and edit it to meet your requirements.

To select a voice, press VOICE to enter voice play mode. The VOICE LED will light red. Select voice memory INTERNAL, CARD, PRESET 1, or PRESET 2. Then select bank A, B, C, or D. Finally select a voice 1–16. The LCD will show the selected voice name.

## 2. Edit parameters/ compare with the original voice

Now that you have selected a voice, press EDIT to edit it. The upper left of the LCD will show “VOICE EDIT”. If “Mode” at the lower left is not displayed in inverse, press F1 to get the following display.

Original data unchanged

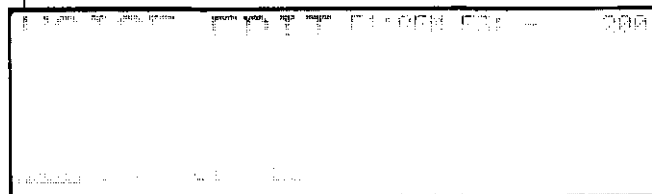

Notice that a small square is displayed at the left of the voice number. This indicates that the voice has not yet been edited. Press  $-1/+1$  to modify the voice mode parameter. (For now, don't worry about what this parameter actually does. Here we are simply learning the *process* of voice editing.) The voice data has now been edited, and this is indicated by an inverse “E” displayed at the left of the voice number.

Data has been edited

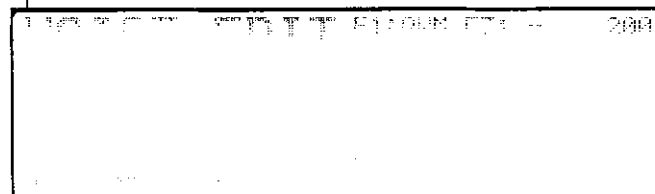

### Note:

While editing, it is often useful to see and hear the original data. (This Compare function is available in most editing screens, but NOT in the screen shown above. Move to another editing screen to try out the Compare function.) To temporarily bring back the original data, press EDIT (COMPARE). Notice that a “C” is now displayed, indicating that you are in Compare mode. While in compare mode you can view the various parameters, but will not be able to modify them. To return to Edit mode, press EDIT (COMPARE) once again, and the “C” will change back to an “E”.

### 3. Store the edited voice

When you have finished editing, you must store the voice if you want to keep it. After you finish editing, exit voice edit mode by pressing EXIT or any mode select key VOICE, MULTI, SONG, PATTERN, or UTILITY. If you have edited the voice data in any way, the top line of the display will ask "AUTO-STORE VOICE" ?

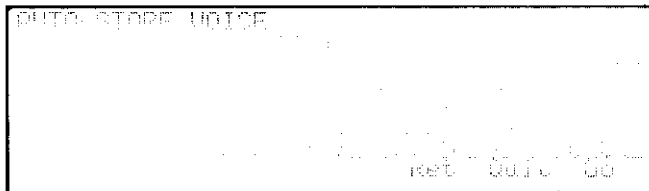

**Note:**

*Voices which use voice mode 3 (4AFM mono), 8 (4AWM poly), and 10 (2AFM&2AWM) occupy extra memory, and can be stored only in bank D. The AUTO-STORE display for such voices will automatically show bank D, and will show "Use bank D" in the bottom line as a reminder.*

*Voices which use other voice modes can be stored in bank D as well.*

The LCD will show the first seven characters of the voicenames in the currently selected bank of voices. The voice name displayed in inverse indicates the voice memory into which the edited data will be stored.

Storing data will overwrite the data that previously occupied that memory, so if you do not want to overwrite the original data, use INTERNAL or CARD to specify the voice memory, select a bank A–D, and select the voice memory 1–16 in which you want to store your newly edited voice.

**Procedure:**

When: you exit editing mode and LCD blinks "AUTO-STORE VOICE"

Specify: the memory into which you wish to store the voice.

To return: to edit mode and continue editing without storing, press F6 (Ret).

To quit: editing and return to voice play mode without storing the edited data, press F7 (Quit). You will exit voice edit mode, and the bottom line of the LCD will show "Store cancelled !" until you press another button.

To store: the data press F8 (Go). The bottom line will ask "Are you sure ? (Yes or No)". If you are sure you want to store the edited voice, press +1/YES and the bottom line of the LCD will show "Store completed". If you decide not to store, press -1/NO and the bottom line of the LCD will show "Store cancelled".

# How voice edit mode is organized

The parameters of a voice are organized into two or more Job Directories, depending on the voice mode. Each job directory lists several groups of parameters. Select a job from the job directory, and edit the parameters in each job.

## Normal voice

If a voice mode of 1–10 is selected, the voice will consist of 1, 2, or 4 elements. Each element will be either an AFM element or an AWM element, depending on the selected voice mode.

Voice parameters will be organized into the following job directories. Press a function key F1–F6 to see the job directories, and select the job you want to edit.

MODE	COM	E1	E2	E3	E4
F1	F2	F3	F4	F5	F6
Specify the Voice Mode	Common data edit job directory	AFM element edit job directory	OR	AWM element edit job directory	
1. 1FM mono 2. 2FM mono 3. 4FM mono 4. 1FM poly 5. 2FM poly 6. 1PCM poly 7. 2PCM poly 8. 4PCM poly 9. 1FM&1PCM poly 10. 2FM&2PCM poly 11. Drum set	1. Element level 2. Element detune 3. Element note shift 4. Element note limit 5. Element velocity limit 6. Element dynamic pan 7. Output select 8. Random pitch 9. Portamento 10. Effect set 11. Micro tuning set 12. Controller set 13. Voice name ... 15. Initialize voice 16. Recall voice	1. Algorithm 2. Oscillator 3. AFM EG 4. AFM operator output 5. AFM sensitivity 6. AFM LFO 7. AFM pitch EG 8. AFM filter ... 15. Initialize FM element 16. Recall FM element		1. AWM waveform set 2. AWM EG 3. AWM output 4. AWM sensitivity 5. AWM LFO 6. AWM pitch EG 7. AWM filter ... 15. Initialize PCM element 16. Recall PCM element	

## Drum voice

If voice mode 11 has been selected, the voice will consist of 61 AWM digital samples, with a sample assigned to each key of the SY77's keyboard. Voice parameters will be organized into the following job directories. Press a function key F1–F2 to see the job directories, and select the job you want to edit.

MODE	COM
F1	F2
Specify the Voice Mode	Drum Set edit job directory
1. 1FM mono 2. 2FM mono 3. 4FM mono 4. 1FM poly 5. 2FM poly 6. 1PCM poly 7. 2PCM poly 8. 4PCM poly 9. 1FM&1PCM poly 10. 2FM&2PCM poly 11. Drum set	1. Voice volume 2. Wave data set 3. Effect set 4. Controller set 5. Name ... 7. Initialize 8. Recall



## How to select a job

Suppose that you are editing a normal voice and want to edit the Note Shift settings for each element. Press F2 to select the Voice Common data job directory.

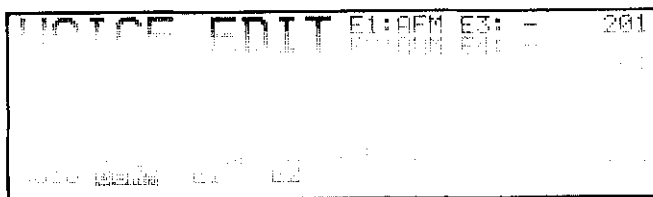

Notice that the note shift parameter is job 03. Use the cursor keys or press 0 then 3 on the numeric key pad to move the inverse cursor to "03.NtShift". Then press ENTER and you will enter the Element Note Shift job.

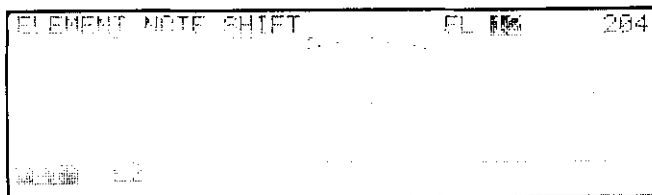

To return to the job directory, press EXIT.

You can use the <> (PAGE) keys to move to other jobs in the same directory. For example from the note shift job, pressing < would take you to job 02.Element Detune, and pressing > would take you to job 04.Note Limit.

# Simple editing: reverb (Effect)

The DSP effect unit adds chorus, echo, reverb, and other effects of spatial ambience. Adjusting the effect is an easy way to change the overall character of a voice.

## Select a voice and enter edit mode

Press VOICE and select a voice. So that it will be easy to hear the result of this editing example (and the editing examples in the following sections), select any bright, sustained voice. The voice names shown in the LCDs in this and following sections are entirely fictitious, and do not correspond to any factory set data.

Press EDIT to enter voice edit mode. Press F2 to select the voice edit Common data job directory, and press 1 then 0 or use the arrow keys to select "10.Effect". Press ENTER and the Effect parameter job directory will appear.

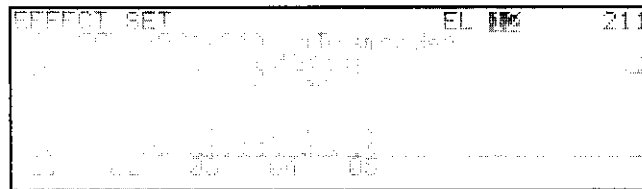

First we will be selecting the Effect Mode. Press F1 to select "01.Effect Mode".

## Select one of three effect modes

The SY77 contains four DSP effects; two modulation-type effects (Mod1 and Mod2) and two reverb-type effects (Rev1 and Rev2). The Effect Mode determines how these four effects are connected. There are three ways of connecting the effects; modes 1, 2, and 3. Mode 0 bypasses the effect units. Use the -1/+1 keys to select the various modes 0-3 and note how the LCD graphically indicates the flow from the pan output at left to the final Out1 and Out2 at right.

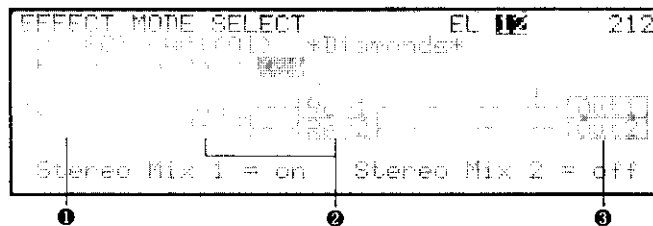

- ① The stereo sound from the voice pan ② is processed through the effects
- ③ and sent out from the rear panel Out1/Out2 jacks.

For this example select effect mode 1.

## Select and adjust a modulation effect

Press the PAGE > button to move to Modulation Effect 1 Set. This parameter is divided into two jobs. Press F1 (Data) and move the cursor to Effect Type. Use the -1/+1 keys to select 02.St.Flange (stereo flanging).



Play the keyboard and notice the swirling or swishing effect. If the effect is not noticeable, move the cursor to Effect Balance or Output Level and set a higher value.

To adjust the parameters of the modulation effect, press F2 (Parm). Move the cursor to Mod.Frequency and use the -1/+1 keys to increase or decrease the speed of modulation while playing the keyboard to hear the result. You can experiment with various settings of the Mod.Depth, Mod.Delay, and Feedback Gain settings as well.



### Select and adjust a reverb effect

Press PAGE▷ twice to select Reverb Effect 1 Set. This parameter is also divided into two jobs. Press F1 (Data), move the cursor to Effect Type, and select 01:Rev.Hall.



Play the keyboard and notice the feeling of spacious ambience as if the instrument were being played in a large, reverberant hall. If the effect is not noticeable, move the cursor to Effect Balance or Output Level and set a higher value.

To adjust the parameters of the reverb effect, press F2 (Parm). Move the cursor to Reverb Time and experiment with various settings. Higher settings will make the reverb longer. You can experiment with various settings of the L.P.F. (Low Pass Filter) and Initial Delay as well.

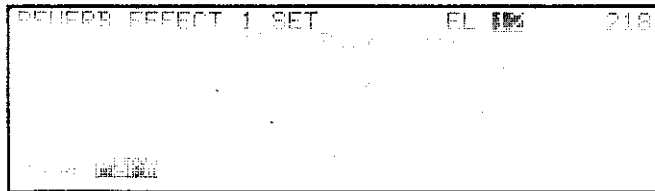

When finished, press EXIT twice to return to the voice edit Common data job directory.

### Bypass the effect to hear the unprocessed sound

Whether or not you are editing the effect, you can press the EF BYPASS button at any time to bypass the effect. When you press EF BYPASS the LED will light, and you can hear the sound without the effect. Press it once again, and the LED will go out and the effect will be applied once again.

# Simple editing: tone (Filter)

Each element in a voice has two filters which can be used to make overall adjustments in tone. A filter can be controlled in various ways. Controlling a filter by key-on velocity is a simple way to make a voice respond expressively to your keyboard playing.

## What is a filter

In electronic musical instruments, a filter removes a specified range of frequencies from the sound, and allows the rest to pass through. For example if the high frequencies are removed and the low frequencies allowed to pass through, the sound will be made darker. This type of filter is called a Low Pass Filter (LPF). The frequency at which the filter begins to affect the sound is called the Cutoff Frequency.

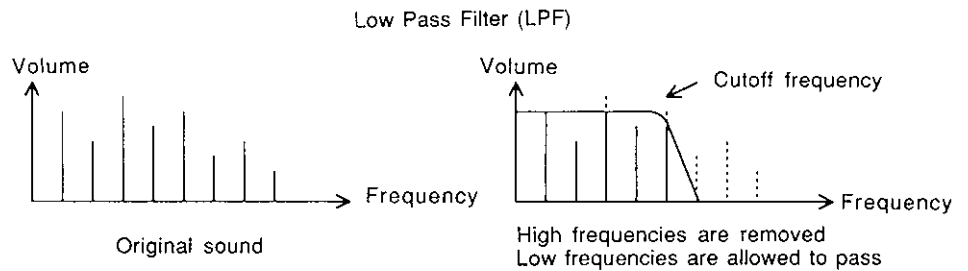

Each of the one two or four elements in a normal voice contains two filters, which can be controlled independently. One filter is fixed as a Low Pass Filter (LPF). The other filter can be used either as a LPF or as a High Pass Filter (HPF); i.e., a filter that allows only high frequencies to pass, resulting in a thinner tone.

## Turn off unwanted elements

Each normal voice consists of one two or four elements, and each element has its own set of two filters. If the voice you are editing contains two or four elements, it may be helpful to listen to only one element as you adjust its filters. To the right of the voice name displayed in the voice edit job directory is a list of the elements used by the currently selected voice.

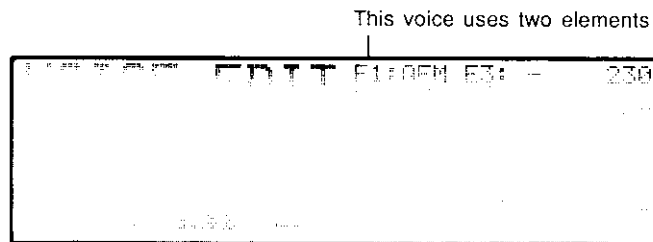

The voice selected in the above display uses two elements. Press EL 2 (the bank B button) to turn off element 2. Now you will hear only element 1. Press EL 2 once again and it will be turned on. You can turn each element on/off at any time while editing.

## Specify the type of filter and the cutoff frequency

Press F3 to select the voice edit Element 1 job directory, select 08:Filter, and press ENTER.

Filter parameters are divided into three jobs. Press F1 to select 01:Cutoff Frequency.



Set both filters 1 and 2 to LPF and 9.510 kHz, and set Velocity Sens = +7. Play notes on the keyboard, softly and then strongly. Notice that as the keyboard is played more strongly, the tone is brighter. This is because the velocity sensitivity setting of +7 allows the key velocity to increase the cutoff frequency of the filter.

Increasing the Resonance setting will boost the frequencies at the cutoff point, making the effect of the filter more noticeable.

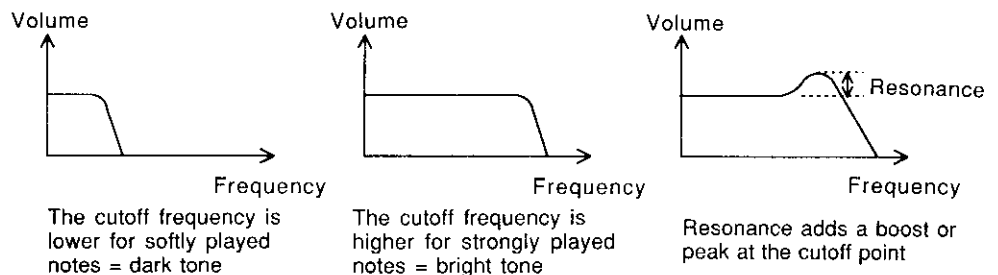

## Other ways to control the filter

The SY77 provides many ways to control the filter in addition to key velocity.

**EG:** Each of the two filters has its own independent EG, which can be used to give each note a fixed pattern of tonal change, such as the characteristic “whaaa” of a brass instrument.

**Note Number:** The note number can affect the rate at which each filter EG changes the tone, and/or affect the width of the change in tone. For example high notes can be made to change in tone more rapidly than low notes, or low notes can be made to change in tone more greatly than high notes.

**Key velocity:** Key velocity can be used to affect the amount of tonal change produced by each filter EG. For example strongly played notes can be made to have a greater change in tone.

**LFO:** Wah-wah (cyclical tone change) occurs when the LFO is applied to the filter block.

**Controllers:** A specified controller (such as modulation wheel or foot controller) can be used to adjust the depth of the wah-wah (Filter Modulation) caused by the LFO.

For example to assign MODULATION 2 to filter cutoff, you must

1. go to System Utility, 3. Controllers (JUMP #803) and check the controller number which is assigned to MODULATION 2 (default 13)
2. go to Voice Common Job 12.Controller Set (JUMP #228) and press F4 (Other)
3. select controller number 13 to affect filter cutoff
4. go to element filter page (for an AFM element JUMP #249, for an AWM element JUMP #265), assign Filter to be controlled by LFO,
5. adjust LFO cutoff sensitivity for the amount of control you wish.
6. If the LFO has already been assigned to affect filter cutoff, you may wish to decrease the LFO F.Mod Depth (for an AFM element JUMP #244, for an AWM element JUMP #261).

Or, a device can be used to directly control the filter EG, for example allowing you to use a controller to continuously adjust the tone during a note.

# Simple editing: vibrato (LFO)

The LFO produces a cyclicly repeating pattern of change. Vibrato is created by applying the LFO to the pitch.

## What is an LFO

A Low Frequency Oscillator (LFO) is a device that produces a waveform at a slow speed (low frequency). This slowly repeating waveform can be applied to various aspects of the sound to cause cyclicly repeating patterns of change. When the LFO is applied to the pitch, vibrato is the result. When the LFO is applied to the filter, wah-wah is the result. When the LFO is applied to the volume, tremolo is the result.

## Adjust the LFO

In this example we will use the LFO to add vibrato to the sound. Move to the Voice Edit job directory, and press F3 to get the Element 1 job directory. If element 1 is AWM, select job 05:LFO. If element 1 is AFM, select job 06:LFO and press F1 to select the Main LFO.

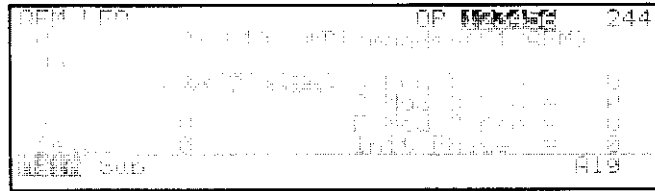

The Main LFOs of AWM and AFM elements are the same. (AFM elements have a Sub LFO which we will not be using in this example.)

Increase the P Mod Depth setting (Pitch Modulation Depth) while playing a note, and you will hear vibrato. If you do not hear any change when you increase the LFO P Mod Depth, you may need to increase the Pitch Modulation Sensitivity (PMS) as explained in the last two paragraphs below.

## Other LFO parameters — Speed and Wave

To regulate the speed of vibrato, move the cursor to Speed and adjust the value over a range of 0–99. Extremely high settings will result in a buzzing sound, and extremely low settings will result in a very slow pitch change.

To modify the shape of the vibrato, move the cursor to Wave and select a different LFO waveform. The selected LFO waveform will be graphically shown in the line below.

Before you proceed to the next section of this example, set P Mod Depth to 0.

## Increase the modulation sensitivity for a AWM element

Press EXIT to return to the Element 1 job directory, and select 04:Sensitiv (sensitivity).

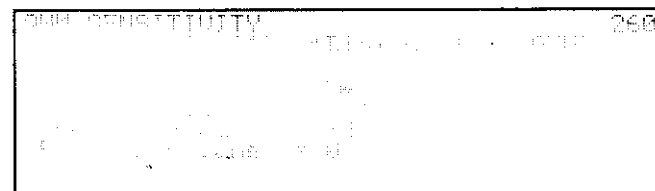



# Simple editing: using a controller

Many acoustic instruments allow the musician to modify the volume, tone, or pitch while a note is being played. The SY77's controllers can be assigned to continuously affect various aspects of the sound for musically expressive control.

## Control makes musical expressiveness possible

On instruments such as piano or organ, there is little that the musician can do to modify the sound once the note has been struck. However on instruments such as wind, brass, or strings, the volume, tone, or pitch can be continuously and freely modified even while sound is being produced. The SY77's Controllers (pitch and modulation wheels, aftertouch, optional foot controllers, etc.) can be used to control various aspects of the sound over the duration of a note. This allows the SY77 to be played with the musical expressiveness of an acoustic instrument.

## Assign a controller to regulate vibrato

In the voice edit job directory, press F2 to get the Common data job directory and select 12:Cntlr (controller). In this example, press F2 (Mod) to get the LFO modulation controller assignment job.

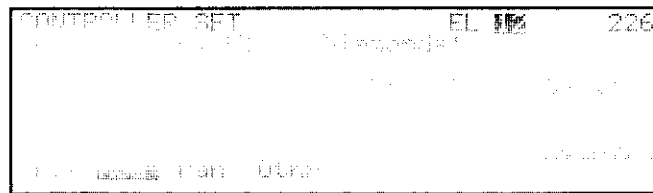

Move the cursor to the Pitch row. Set Depth to its maximum value of 127 and set 001 Modulation. With this setting, the MODULATION 1 wheel will regulate the depth of pitch modulation over its full range. Move the MODULATION 1 wheel and notice that vibrato deepens as you move the wheel forward. You will probably find that when the wheel is fully forward, the effect is too extreme to be musically useful. Decrease the Depth setting so that the full range of the wheel is musically useful.

In this example, you assigned the MODULATION 1 wheel to control pitch modulation, but any other controller could have been used instead. It is also possible to assign two or more parameters to be regulated by the same controller.

## Adjust the pitch bend range

The controllers for pitch bend are fixed; the PITCH wheel located at the left of the keyboard, and aftertouch (pressing down on the keyboard after playing a note). Press F1 (PB) to get the following display.

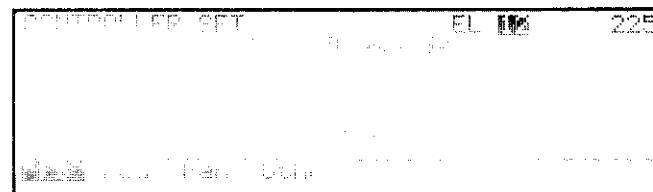



With the settings as shown in the display, the PITCH wheel will bend the pitch up or down by two half steps, and aftertouch will have no effect on pitch. Modify the Pitch Bend Wheel value in the display, and move the PITCH wheel up and down to hear how the the pitch is affected.

Next move the cursor to After Touch Pitch Bend and try out both positive and negative settings while playing a note and then varying the pressure on the keyboard.

### **Other controller assignments**

F3 (Pan) allows you to set make controller assignments for pan, and F4 (Othr) for various other parameters.

Except for pitch bend, a different controller can be freely assigned to each parameter.

# Simple editing: attack (EG)

The Envelope Generator (EG) determines how a sound attacks (begins) and decays (ends).

## What is an envelope generator

Most instruments have a characteristic pattern in which the volume or tone changes over time. In electronic instruments, this is determined by the envelope generator (EG). The EG produces a fixed pattern of change over time. For example to simulate the attack and decay of a piano, you would set the volume EG to be loud when the note is first played and then gradually diminish in volume. The EGs of the SY77 allow you to specify a change over time by settings Levels and Rates. The levels are volume levels, and the rates determines the speed of change that leads to the next level.

In this example, we will be adjusting only R1 (rate 1) to change the attack of the sound.

AWM element EGs are slightly different from AFM element EGs. If you are editing an AWM element, continue to the next section "Adjusting the attack of an AWM element". If you are editing an AFM element, skip to the last section "Adjusting the attack of an AFM element".

## Adjusting the attack of an AWM element

For an AWM element, the amplifier block EG determines how the volume of each note will change over time. From the AWM element 1 job directory, select 02:EG. If the Mode is set to "hold", change it to "attack".

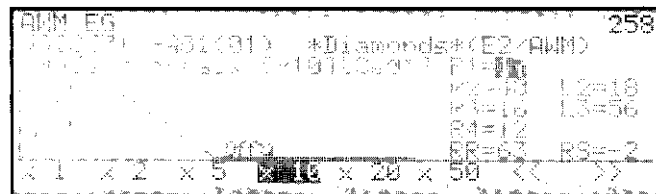

Move the cursor to R1 (rate 1) and decrease the value while repeatedly playing notes. Notice that as R1 decreases, the attack becomes slower.

## Adjusting the attack of an AFM element

For an AFM element, the EG of each operator determines how each note will change over time. From the AFM element 1 job directory, select 03:EG. Press F2 (All) and then press F3 (OnR) (key-on rates).

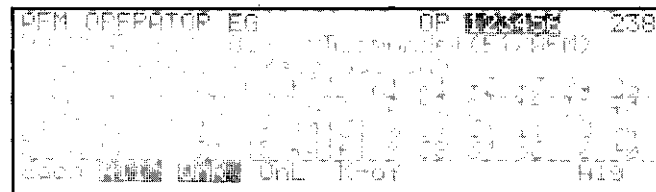

The EGs of carrier operators determine how the volume will change over time, and the EGs of modulator operators determine how the tone will change over time. To see which operators are acting as carriers, press F8 (Alg) to get a graphic display of the algorithm. The operators in the bottom row are acting as carriers.

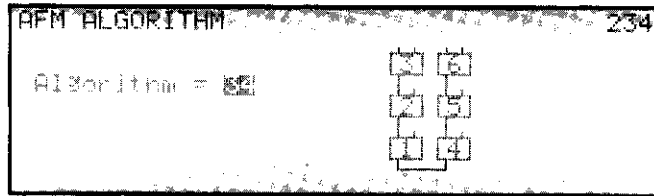

Move the cursor to R1 (rate 1) of the carrier operator(s), and decrease the value while repeatedly playing notes. Notice that as R1 decreases, the attack becomes slower.

Depending on how the modulator operators are being used, it may be necessary to decrease R1 for modulator operators as well.

# How to name and store your new voice

If you have followed along with the last five “Simple editing” sections, the voice is now probably quite different than when you first selected it. Even if the voice sounds rather strange, give it a new name and store it as explained in this section.

## Enter a 10-character voice name

From the voice edit Common data job directory, select 13:Name.

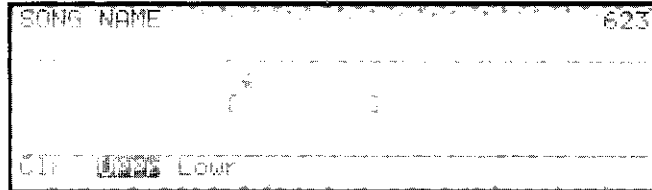

Press F1 (Clr) to clear the currently set voice name, and use the numeric keypad to enter the characters printed below each key. Press F2 to select uppercase characters and press F3 to select lowercase characters. Use <> to move the cursor.

For example to enter the voice name “New1”, use < to move the cursor to the beginning of the line, and press the following buttons; F2 to select uppercase, 4 three times to enter “N”, >, F3 to select lowercase, 1 three times to enter “e”, >, 7 three times to enter “w”, >, and 1 once to enter “1”.

## Store the edited voice

When you have finished entering the voice name, press the mode select key VOICE to exit to the voice edit Common job directory, and press EXIT once again to exit voice edit mode. Since the voice data has been edited, the top line of the display will blink “AUTO-STORE VOICE”

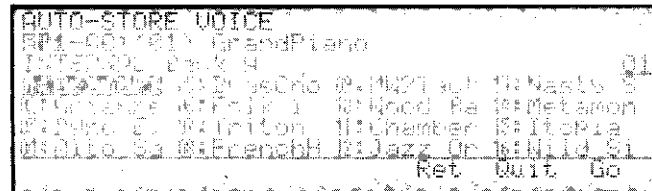

### Note:

*Voices which use voice mode 3 (4AFM mono), 8 (4AWM poly), and 10 (2AFM&2AWM) occupy extra memory, and can be stored only in bank D. The AUTO-STORE display for such voices will automatically show bank D, and blink “Use bank D” in the bottom line as a reminder.*

*Voices which use other voice modes can be stored in bank D as well.*

The LCD will show the first seven characters of the voicenames in the currently selected bank of voices. The voice name displayed in inverse indicates the voice memory into which the edited data will be stored.

Storing data will overwrite the data that previously occupied that memory, so if you do not want to overwrite the original data, use INTERNAL or CARD to specify the voice memory, select a bank A–D, and select the voice memory 1–16 in which you want to store your newly edited voice.

For example to store your new voice in Internal memory bank C memory number 16, press INTERNAL, then C then 16.

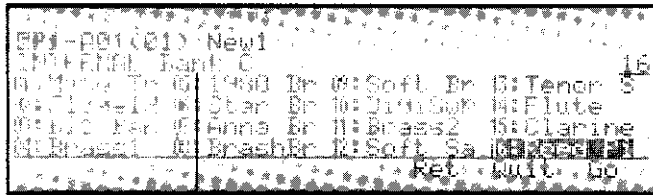

The voice will be stored into this memory

Press F8 (Go), and the bottom line will ask “Are you sure ? (Yes or No)”. If you are sure you want to store the edited voice, press +1/YES and the bottom line of the LCD will show “Store completed”. If you decide not to store, press -1/NO and the bottom line of the LCD will show “Store cancelled”.

You will then return to voice play mode.

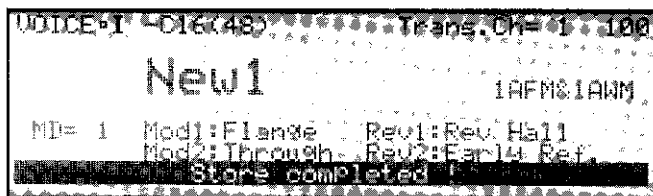



```

WAVE DATA SET                               274
VOICE#016(48) New1 (Drum Set)
Wave Name Number : 01
Wave no. = 97
Level = 127 Note Shift = - 5
Alternate = off Fine Tune = + 0
Default Group = both Static Pan = + 0
K-Dn K-Up Pre Card

```

Next select note C#1 and specify preset wave number 97 SD 1 (snare drum).

```

WAVE DATA SET                               274
VOICE#016(48) New1 (Drum Set)
Wave Name Number : 0#1
Wave no. = 97
Level = 127 Note Shift = + 5
Alternate = off Fine Tune = + 0
Default Group = both Static Pan = + 0
K-Dn K-Up Pre Card

```

In this way, make the following settings for notes C1–F# to create the simple seven-instrument drum set shown in the table below. For notes F and F# set Alternate to “on”.

Note	Wave no.	Wave name	Alternate
C1	93	BD 1	off
C#1	97	SD 1	off
D1	102	Tom 1	off
D#1	103	Tom 2	off
E1	107	Ride	off
F1	104	HH closed	on
F#1	105	HH open	on

### Alternate On/Off

Play notes C1–F#1 to play your new drum set. Notice that when you play F#1 (hi-hat open) and then quickly play F1 (hi-hat closed), the open hi-hat will stop sounding when the closed high sound begins. It is impossible for a real hi-hat to produce closed and open sounds at the same time, and this is the reason that we set these two waves to Alternate On. When two or more waves are set to alternate On, the last-played wave will take priority and the previously played wave will be turned off.

### Other wave data settings

The volume of each note is adjusted by Level. The tuning of each note is adjusted in half steps by Note Shift and finely by Fine Tune. The stereo position of each note is determined by Static Pan.

The *Voice edit mode, Drum set data* section explains the details of these and other parameters.

### Name and store your new drum voice

As explained in the previous section, give your newly created drum voice a name and store it into memory. The previous section of this manual *How to use the sequencer* has shown how to use the sequencer to play a drum voice along with other parts in a song.





# REFERENCE SECTION



# VOICE PLAY MODE

You will normally play the SY77 in voice play mode. In voice play mode you can do the following things.

- Select voices from preset, internal, or card memory.
- View a directory of the 16 voices in the currently selected bank of internal, card, or preset memory.
- Copy the currently selected voice to any internal or card memory.
- View the controller assignments for the currently selected voice.
- Send a program change to an external device.

## Voice select

JUMP #100

Press VOICE to enter voice play mode. The following LCD will appear.

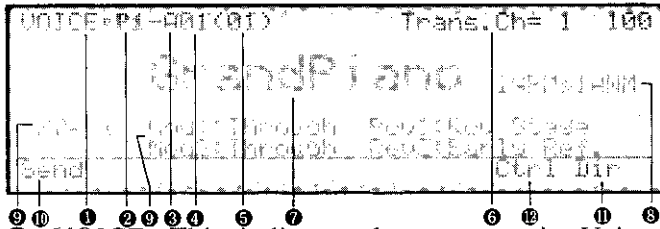

- ① VOICE: This indicates that you are in Voice Play mode.
- ② Voice memory (I, C, P1, P2): This indicates the voice memory; Internal, Card, Preset 1, or Preset 2.
- ③ Bank (A–D): This indicates the voice memory bank.
- ④ Voice number in individual bank (1–16): This indicates the number of the voice in the bank.
- ⑤ Voice number in banks A–D (1–64): This indicates the voice as a number between 1 (voice 1 of bank A) to 64 (voice 16 of bank D).
- ⑥ Transmit channel (1–16): This indicates the transmit channel you selected in *MIDI Utility 1. Channel set* (JUMP #807). The SY77 keyboard will transmit from MIDI OUT on this channel.
- ⑦ Voice name: The voice name is displayed in large characters.

- ⑧ Voice mode: This indicates the type and number of elements used by this voice. For details refer to *Voice Edit mode, Voice Mode Select*.
- ⑨ Effect settings: This area indicates the effect mode (off, 1–3) and type of effect selected by this voice for each of the four DSP units; Modulation 1 and 2, and Reverb 1 and 2. For details refer to *Voice Edit mode, Common Data job 10. Effect set*.
- ⑩ Refer to the following section *Send program change*.
- ⑪ Refer to the following section *Voice directory*.
- ⑫ Refer to the following section *Controller view*.

To select a voice use the following procedure. The voice will not actually change until you specify the voice number 1–16. If you want to play a different voice in the same bank, simply specify a different number 1–16.

1. Select the voice memory; INTERNAL, CARD (only if a card is inserted into the DATA slot), PRESET 1, or PRESET 2. The selected LED will blink.
2. Select a bank A, B, C, or D. The selected LED will blink.
3. Select a voice 1–16. The selected LED will light, and the LCD display will show the newly selected voice name.

## Voice directory

JUMP #101

**Summary:** This function allows you select voices while viewing a directory of the sixteen voices in the currently selected voice bank.

**Procedure:**

- From: voice play mode (JUMP #100)  
 Select: F8 (Dir) (JUMP #101)  
 Specify: one of the displayed voices  
 To quit: and return to the voice play display press EXIT.

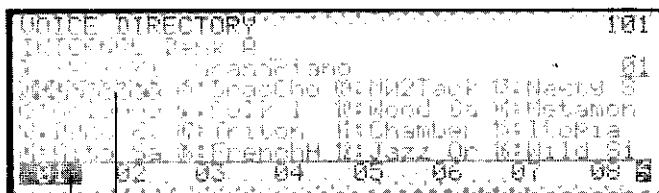

- ① The first seven characters of each ten-character voice name will be displayed. When you select a different voice memory (internal, card, preset 1, or preset 2) and voice bank (A–D) the sixteen voices in the newly selected bank will be displayed. In addition to the usual methods of selecting a voice, you can also use the arrow keys to select a voice. When the voice directory is displayed, pressing a memory select button or bank select button will immediately select a voice.

- ② Pressing F1–F8 (01)–(08) will select a voice 1–8 from the displayed voice bank. Holding SHIFT and pressing F1–F8 (09)–(16) will select a voice 9–16 from the displayed voice bank.

To return to the voice play display with the single voice name displayed in large characters press EXIT.

## Copy voice

**Summary:** Anytime in voice play mode you can copy the currently selected voice to another voice memory.

**Procedure:**

From: voice play mode (JUMP #100)

Press: COPY

Specify: the destination to which the voice will be copied.

To execute: the copy operation press F8 (Go).

To quit: without executing press EXIT.

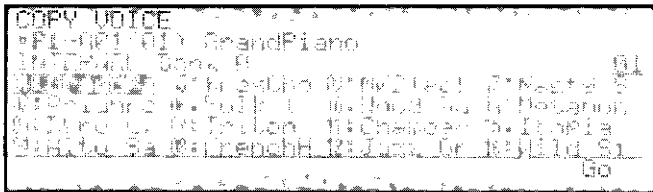

The names of the sixteen voices in the currently selected bank of Internal or Card memory are displayed as explained in *Voice Directory*. Press INTERNAL or CARD, press a bank button A–D, and press a memory select button 1–16 to specify the copy destination.

After specifying the copy destination press F8 (Go). You will be asked “Are you sure?” If you are sure you want to copy the voice, press YES and the data will be copied. To quit without copying press NO.

## Controller view

JUMP #102

**Summary:** This function allows you to view the controller assignments for the voice as a reminder of how the voice can be controlled.

**Procedure:**

From: voice play (JUMP #100)

Select: F7 (Ctrl) (JUMP #102)

To quit: and return to voice play mode press EXIT.

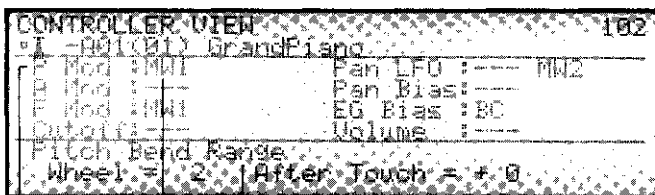

- ① Parameter: The left side of each column displays the parameter which is being controlled. The actual effect that a controller will have on the parameter to which it is assigned will depend on

the depth that is specified for each controller assignment as explained in *Voice Common job 12. Controller*.

- ② Controller: The right side of each column displays the controller which is assigned to control each parameter. The range is not displayed. “–” will be displayed to indicate a controller which the SY77 itself does not have, or to indicate that the parameter’s depth has been set in such a way that the controller has no effect. (Refer to *Voice Common, Controller Set*.)
- ③ Pitch Bend Range: This area shows the range over which the PITCH wheel can raise or lower the pitch, and the maximum pitch change that will result when you press down on the keyboard after playing a note (Aftertouch).

This function allows you to only view the controller assignments. To edit them, refer to *Voice Common job 12. Controller*.

## Send program change

**Summary:** Anytime in voice play mode you can transmit a program change message from MIDI OUT without affecting the SY77's own tone generator. This allows you to switch a tone generator module connected to the SY77 MIDI OUT to another memory without changing the SY77's own memory.

**Procedure:**

From: voice play mode (JUMP #100)  
 Select: F1 (Send)  
 Specify: a program change number 1-128  
 To transmit: the program change press ENTER.  
 To quit: without sending a program change press EXIT.

1. Use the numeric key pad to enter a one two or three digit number 1-128.
2. Press ENTER and a program change message of the specified number will be transmitted on the *Kyb Trans Ch* (keyboard transmit channel) specified in *MIDI Utility job 1. Channel set* (JUMP #807). The LCD will show the transmitted number; e.g., "Completed ! PC No.=128".

If you enter a number below 1 it will be transmitted as 1. If you enter a number above 128 it will be transmitted as 128.

In addition to the program change message transmitted by this function, a program change message will be transmitted every time you select a SY77 voice or multi unless *Utility mode MIDI Utility 2. Program change* (JUMP #808) has been turned off.

# VOICE EDIT MODE

This section explains the details of all Voice Edit parameters.

<b>Contents of this section</b>	<b>page</b>
<b>Voice mode select</b> .....	<b>91</b>
<b>Common data</b> .....	<b>92</b>
<b>AFM element data</b> .....	<b>116</b>
<b>AWM element data</b> .....	<b>138</b>
<b>Drum set data</b> .....	<b>149</b>

## VOICE EDIT MODE

The organization of Voice Edit mode will depend on whether the voice is a Normal voice or a Drum voice.

MODE	COM	E1	E2	E3	E4
F1	F2	F3	F4	F5	F6
Specify the Voice Mode	Common data edit job directory	AFM element edit job directory	OR	AWM element edit job directory	
<ol style="list-style-type: none"> <li>1. 1FM mono</li> <li>2. 2FM mono</li> <li>3. 4FM mono</li> <li>4. 1FM poly</li> <li>5. 2FM poly</li> <li>6. 1PCM poly</li> <li>7. 2PCM poly</li> <li>8. 4PCM poly</li> <li>9. 1FM&amp;1PCM poly</li> <li>10. 2FM&amp;2PCM poly</li> <li>11. Drum set</li> </ol>	<ol style="list-style-type: none"> <li>1. Element level</li> <li>2. Element detune</li> <li>3. Element note shift</li> <li>4. Element note limit</li> <li>5. Element velocity limit</li> <li>6. Element dynamic pan</li> <li>7. Output select</li> <li>8. Random pitch</li> <li>9. Portamento</li> <li>10. Effect set</li> <li>11. Micro tuning set</li> <li>12. Controller set</li> <li>13. Voice name</li> <li>...</li> <li>15. Initialize voice</li> <li>16. Recall voice</li> </ol>	<ol style="list-style-type: none"> <li>1. Algorithm</li> <li>2. Oscillator</li> <li>3. AFM EG</li> <li>4. AFM operator output</li> <li>5. AFM sensitivity</li> <li>6. AFM LFO</li> <li>7. AFM pitch EG</li> <li>8. AFM filter</li> <li>...</li> <li>15. Initialize FM element</li> <li>16. Recall FM element</li> </ol>		<ol style="list-style-type: none"> <li>1. AWM waveform set</li> <li>2. AWM EG</li> <li>3. AWM output</li> <li>4. AWM sensitivity</li> <li>5. AWM LFO</li> <li>6. AWM pitch EG</li> <li>7. AWM filter</li> <li>...</li> <li>15. Initialize PCM element</li> <li>16. Recall PCM element</li> </ol>	



## Compare

When you are in edit mode but have not yet modified the data, a small square ■ is displayed at the left of the voice number to indicate that the voice has not yet been edited. If the data is edited in any way, this will change to a inverse “E”.

If you want to see and hear the original data press EDIT (COMPARE) and the inverse “E” will change to a “C” indicating that you are in compare mode. To return to edit mode press EDIT (COMPARE) once again and the “C” will change back to an “E”.

### Note:

- The Compare function is not available in the job directory displays, nor while editing Dynamic Pan or Micro Tuning.
- If the Voice Mode has been changed, the Compare function will not be available.
- While comparing, it is not possible to modify parameter values. (However there are some exceptions.)
- If you compare while editing a card voice, a card error will cancel compare after displaying an error message.
- While comparing, EXIT, mode select, page, cursor, JUMP, COPY, and some of F1–F8 will not function.

## Store voice

When you press EXIT or use the JUMP button to exit Voice Edit mode after editing the data, the top line of the display will blink “AUTO-STORE VOICE”

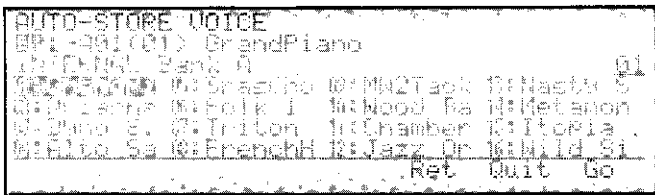

### Note 1:

Four-element voices, i.e., voices using voice mode 3 (4AFM mono), 8 (4AWM poly), or 10 (2AFM&2AWM) occupy extra memory, and can be stored only in bank D. The AUTO-STORE display for such voices will automatically show bank D, and blink “Use bank D” in the bottom line as a reminder.

Voices which use other voice modes can be stored in bank D as well.

### Note 2:

When storing a voice which uses an AWM waveform card, make sure that the correct card is

inserted when you store, since the waveform card ID number is stored as part of the voice.

The LCD will show the first seven characters of the voice names in the currently selected bank of voices. The voice name displayed in inverse indicates the voice memory into which the edited data will be stored.

1. Use INTERNAL or CARD to specify the voice memory, select a bank A–D, and select the voice memory 1–16 in which you want to store your newly edited voice.
2. Press F8 (Go), and the bottom line will ask “Are you sure ? (Yes or No)”.
3. If you are sure you want to store the edited voice, press +1/YES and the bottom line of the LCD will show “Store completed”. If you decide not to store, press –1/NO and the bottom line of the LCD will show “Store cancelled”.
4. You will then return to voice play mode or the jump destination.

## Element on/off

When editing a voice which uses two or more elements, it is often useful to hear only the element being edited. At any time while editing a normal voice, pressing the ELEMENT ON/OFF buttons located at the upper right of the front panel will turn individual elements off/on. When editing voice common data, the number and type of elements used by the voice will be shown in the upper right of the display. Elements that are on will be displayed in inverse. In addition the LEDs above the ELEMENT ON/OFF buttons will light if the element is on and be darkened when the element is turned off. In the following LCD, element 2 has been turned off, and will not be heard.

Element 2 has been turned off.

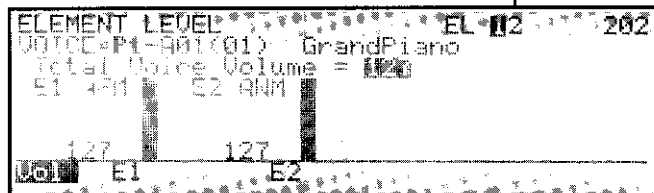

When editing Drum Set data the ELEMENT ON/OFF buttons will have no effect.

When you move to the Voice Mode Select display, the element on/off settings will automatically be cancelled.

## Element select

At any time while editing the element data of a normal voice, you can use the ELEMENT SELECT buttons located at the upper right of the front panel to select an element to edit. This is often faster than returning to the top level of voice edit mode and pressing F3-F6 to select the job directory of a different element.

When editing Voice Common data or Drum Set data the ELEMENT SELECT buttons will have no effect.

## Voice mode select

**Summary:** The voice mode setting determines whether a voice will consist of one two or four AWM or AFM elements (modes 1–10), or 61 AWM waves (mode 11).

**Procedure:**

From: the top level of voice edit mode  
(JUMP #200, #201, #230, #256)

Press: F1 (Mode) to get the following display  
(JUMP #200)

Specify: the desired voice mode.

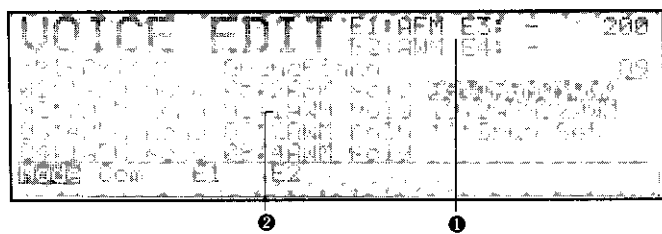

❶ This area shows the number (1, 2, or 4) and type (AWM or AFM) of elements in the selected voice mode.

❷ Move the cursor to the desired voice mode 1–11. The selected voice mode will become effective immediately.

01: 1AFM mono: The voice consists of one AFM element.

02: 2AFM mono: The voice consists of two AFM elements.

03: 4AFM mono: The voice consists of four AFM elements. (See note)

04: 1AFM poly: The voice consists of one AFM element.

05: 2AFM poly: The voice consists of two AFM elements.

06: 1AWM poly: The voice consists of one AWM element.

07: 2AWM poly: The voice consists of two AWM elements.

08: 4AWM poly: The voice consists of four AWM elements. (See note)

09: 1AFM&1AWM: The voice consists of one AFM and one AWM element.

10: 2AFM&2AWM: The voice consists of two AFM and two AWM elements. (See note)

11: Drum Set: The voice consists of sixty-one AWM samples.

**Mono modes (1–3):** Voices which use modes 1–3 are monophonic. Only one note can be produced at a time. If a note is played while the previous note is still sounding, the previous note will be cut off. Mono mode is useful when simulating instruments that naturally produce only one note at a time. Mono mode also allows you to use a special type of portamento; *fingered portamento*. For details refer to *Voice Common 9. Portamento*.

**Polyphonic modes (4–10):** Voices which use modes 4–10 are polyphonic, and will allow you to play chords of as many notes as can be produced by the SY77's tone generator. The AWM and AFM tone generators can each produce up to 16 simultaneous notes. For some voice modes more than one element may be sounded by a single key, and this will correspondingly reduce the number of simultaneous notes you can play.

**Drum Set mode (11):** Drum set voices use only the AWM tone generator, and up to 16 AWM samples can be sounded simultaneously.

**Note:** Four-element voices (modes 3, 8, and 10) can be stored only in bank D.

## Common data

COMMON DATA

### Common data job directory

JUMP #201

**Summary:** This job directory shows the jobs containing data that affects all elements in the voice.

**Procedure:**

- From: the top level of voice edit mode
- When: editing a normal voice
- Press: F2 (Com) (JUMP #201)
- Select: the desired job

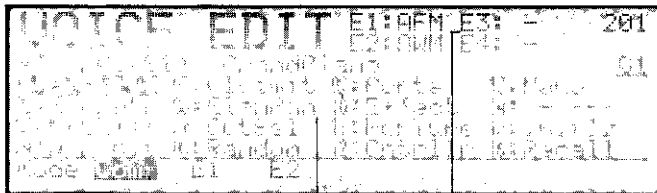

- ❶ This area shows the number (1, 2, or 4) and type (AWM or AFM) of elements in the selected voice mode.
- ❷ Move the cursor in this area to select a job.
  - 01: ElemLvl (Element level): Total voice volume, and element level
  - 02: ElemDtn (Element detune): Fine tuning for each element
  - 03: NtShft (Note shift): Transpose each element

- 04: NtLimt (Note limit): Range of notes that play each element
- 05: VILimt (Velocity limit): Range of key-on velocities that play each element
- 06: ElemPan (Element dynamic pan): Dynamic panning table for each element
- 07: OutSel (Output group select): Output group for each element
- 08: Random (Random pitch): Random pitch variation for entire voice
- 09: Porta (Portamento): Portamento mode and time
- 10: Effect (Effect set): Effect set job directory
- 11: McrTune (Micro tuning): Micro tuning select for entire voice, and element off/on
- 12: CtrlR (Controller set): Controller assignments and depth for pitch bend, modulation, pan, etc.
- 13: Name (Voice name): Ten-character voice name
- 15: Initlz (Initialize voice): Initialize the voice common data being edited
- 16: Recall (Recall voice): Recall all data (common and element) of the previously edited voice

COMMON DATA

## 1. Element level

JUMP #202

**Summary:** Adjust the overall volume of the entire voice, and the volume of individual elements 1-4.

**Procedure:**

- From: voice common job directory (JUMP #201)
- Select: job 01:ElemLvl (JUMP #202)
- Specify: the total voice volume and the levels of each element

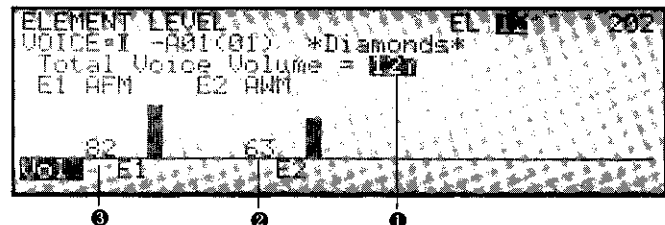

- ❶ Total voice volume (0...127): This determines the overall volume of the entire voice.

- ② Element level (0...127) E1-E4: These determine the volume level of each element. Press F2, F4, F6, F8 to move the cursor to elements 1-4. The level of each element is displayed as a vertical bar graph.
- ③ Pressing F1 will move the cursor to Total Voice Volume. Pressing F2, F4, F6, F8 will move the cursor to elements 1-4.

**Remarks:** Since the total voice volume setting is part of the voice data, it can be used to even out the volume differences between voices. This is important when editing a set of voices for live performance, and allows you to avoid any sudden jumps in volume when a voice is selected.

COMMON DATA

## 2. Element detune

JUMP #203

**Summary:** Adjust the fine tuning of individual elements 1-4.

### Procedure:

From: voice common job directory (JUMP #201)  
 Select: job 02:ElemDtn (JUMP #203)  
 Specify: the tuning of each element

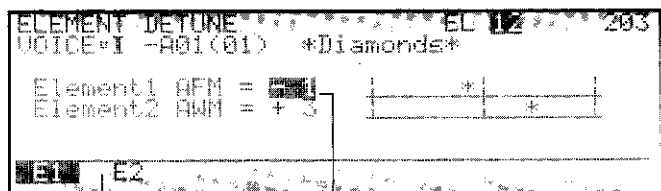

- ① Detune (-7...+7) E1-E4: When this is set to 0, the element will play the correct pitch for the key that was pressed. Negative settings will lower

the pitch, and positive settings will raise the pitch. The tuning of each element is displayed as a horizontal bar graph.

- ② Pressing F1-F4 will move the cursor to elements 1-4.

**Remarks:** If you are creating a voice that plays two or more elements for a single note, slightly detuning the elements will create a natural chorus effect, giving a richer quality to the sound.

Element detune is intended to change the *relative* pitch of two or more elements. Setting all elements to the same detune value will not be useful, nor will this setting be useful if the voice contains only one element.

COMMON DATA

## 3. Note shift

JUMP #204

**Summary:** Transpose the pitch of individual elements 1-4.

### Procedure:

From: voice common job directory (JUMP #201)  
 Select: job 03:NtShift (JUMP #204)  
 Specify: the transposition of each element

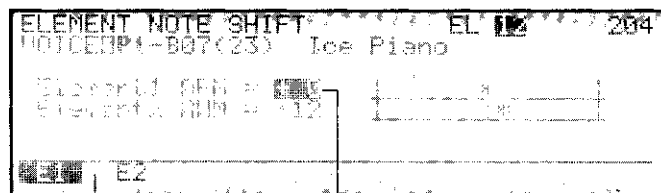

- ① Note Shift (-64...+63) E1-E4: When this is set to 0, the element will play the correct pitch for

the key that was pressed. This setting adjusts the pitch in units of a half step. For example if set to -12 the pitch will be one octave lower than normal, and if set to +24 the pitch will be two octaves higher than normal.

- ② Pressing F1-F4 will move the cursor to elements 1-4.

**Remarks:** The note shift setting can be useful when you need play notes that are beyond the range of the SY77's 61-note keyboard. For voices which play two or more elements for each key, note shift can be used to create automatic parallel harmony.

COMMON DATA 4. Note limit JUMP #205

**Summary:** Specify the range of notes that will play each element.

**Procedure:**

- From: voice common job directory (JUMP #201)
- Select: job 04:NtLimit (JUMP #205)
- Specify: the note range for each element

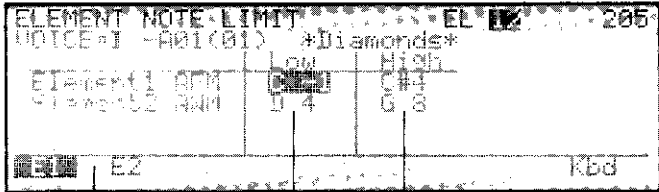

- 1 Low Note Limit (C-2...G8) E1-E4: This specifies the lowest note that will be played by the element.
- 2 High Note Limit (C-2...G8) E1-E4: This specifies the highest note that will be played by the element.
- 3 Pressing F1-F4 will move the cursor to elements 1-4.

**Remarks:** After moving the cursor to the parameter you want to set, you can modify the data in the usual way or press F8 (Kbd) and then press a key of the SY77's keyboard to enter a note. (The notes of the SY77 keyboard are C1-C6.)

If you want to play an element over the entire range of the keyboard, leave this parameter set at Low=C-2 and High=G8.

This parameter can be used to create keyboard split effects where different elements are played by different keyboard areas. For example

in a two-element voice where element 1 is a bass sound and element 2 is a piano sound, set element 1 to Low=C1 and High=B2 and set element 2 to Low=C3 and High=C5. With these settings, notes below middle C will play bass (element 1) and notes above middle C will play piano (element 2).

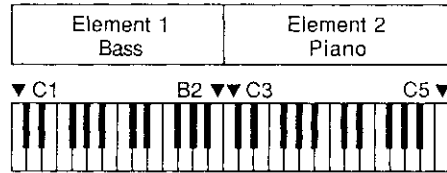

It is possible to set the low limit above the high limit. In this case, the element will be played by notes above the low limit and below the high limit. The following diagram shows the keyboard range that would play an element set to Low=C4 and High=C2.

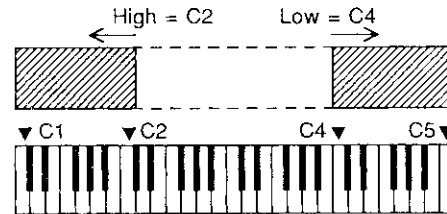

*Note: This note limit setting will be ignored if the voice mode is mono (voice mode 1:1AFM mono, 2:2AFM mono, and 3:4AFM mono).*

COMMON DATA 5. Velocity limit JUMP #206

**Summary:** Specify the range of key-on velocities that will play each element.

**Procedure:**

- From: voice common job directory (JUMP #201)
- Select: job 05:VILimit (JUMP #206)
- Specify: the range of velocities for which the element will sound

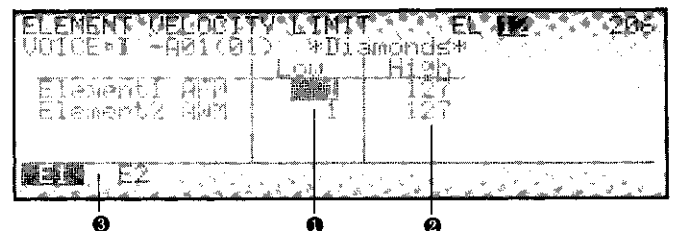

- 1 Low Velocity Limit (1...127): This is the lowest key-on velocity for which the element will sound.

- ② High Velocity Limit (1...127): This is the highest key-on velocity for which the element will sound.
- ③ Press F1-F4 to move the cursor to elements 1-4.

**Remarks:** If you want to play an element over the full range of key velocities, leave this parameter set at Low=1 and High=127. This parameter can be used to make strongly played notes play different elements than softly played notes. For example in a two-element voice where element 1 is a piano sound and element 2 is a brass sound, set element 1 to Low=1 and High=100 and set element 2 to Low=101 and High=127. With these settings, soft notes will play the piano (element 1) and strong notes will play brass (element 2). If desired, you could overlap the velocity limits of the elements, or use more than two elements.

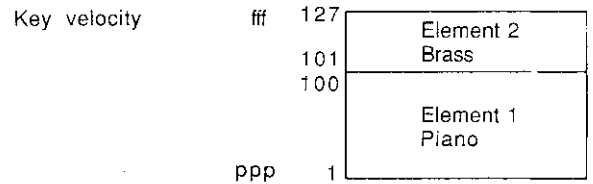

It is possible to set the low limit above the high limit. In this case, the element will be sounded by key-on velocities outside the limits. The following diagram shows the velocity range that would play an element set to Low=100 and High=40.

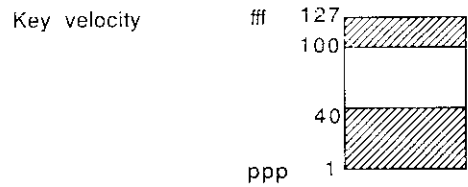

COMMON DATA

## 6. Element dynamic pan

JUMP #207

**Summary:** Select the Dynamic Pan data used by each element. The selected dynamic pan data will determine how the stereo position of the element will change over time.

**Procedure:**

- From: Voice Common job (JUMP #201) directory
- Select: job 06:ElemPan (JUMP #207)
- Specify: the Dynamic Pan data used by each element

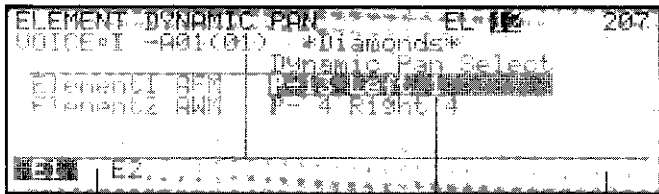

- ① Dynamic Pan Select (I1...32, C1...32, P1...64): This specifies the dynamic pan data that will move the stereo position of this element over time. The number and name of the selected pan data will be displayed. For an internal voice, select a pan data memory from Internal or Pre-set. For a card voice, select a pan data memory from Card or Preset.

- ② Pressing F1-F4 will move the cursor to elements 1-4.
- ③ Press F8 to edit the currently selected pan data. (Only Internal pan data can be edited.)

**Remarks:** Each Dynamic Pan memory contains the following data.

- a Pan Source which allows the panning movement to be controlled by velocity, note number, or LFO
  - EG settings which determine panning movement over time
  - a Pan Name
- 64 preset dynamic pan memories are provided, as explained in the following table. In addition, 32 internal memories are provided for you to store your own pan data, and a RAM card can accommodate 32 more pan data memories. The following section 6.0 Dynamic Pan Edit explains how to edit the Dynamic Pan data.

## VOICE EDIT MODE

Preset Dynamic Pan data

#	Name	Description
1	Center	fixed at center
2	Right 6	fixed full right
3	Right 5	...
4	Right 4	...
5	Right 3	...
6	Right 2	...
7	Right 1	fixed slightly right
8	Left 6	fixed full left
9	Left 5	...
10	Left 4	...
11	Left 3	...
12	Left 2	...
13	Left 1	fixed slightly left
14	L>R slow	slowly move L→R
15	L>R	move L→R
16	L>R fast	quickly move L→R
17	R>L slow	slowly move R→L
18	R>L	move R→L
19	R>L fast	quickly move R→L
20	C>R slow	slowly move C→R
21	C>R	move C→R
22	C>R fast	quickly move C→R
23	C→R slow	pause at center then slowly move C→R
24	C→R	pause at center then move C→R
25	C→R fast	pause at center then quickly move C→R
26	C>L slow	slowly move C→L
27	C>L	move C→L
28	C>L fast	quickly move C→L
29	C→L slow	pause at center then slowly move C→L
30	C→L	pause at center then move C→L
31	C→L fast	pause at center then quickly move C→L
32	L<>R slow	start at L then slowly move between LR
33	L<>R	start at L then move between LR
34	L<>R narrow	start at L then move (narrowly) between LR
35	L<>R fast	start at L then move quickly between LR
36	R<>L slow	start at R then slowly move between RL

#	Name	Description
37	R<>L	start at R then move between RL
38	R<>L narrow	start at R then move narrowly between RL
39	R<>L fast	start at R then move quickly between RL
40	C>R<>L slw	start at C then move slowly between RL
41	C>R<>L s&n	start at C then move slowly and narrowly between RL
42	C>R<>L	start at C then move between RL
43	C>R<>L fst	start at C then move quickly between RL
44	C→R<>L sl	pause at C then move slowly between RL
45	C→R<>L	pause at C then move between RL
46	C→R<>L fs	pause at C then move quickly between RL
47	C>L<>R slw	start at C then move slowly between LR
48	C>L<>R s&n	start at C then move slowly and narrowly between LR
49	C>L<>R	start at C then move between LR
50	C>L<>R fst	start at C then move quickly between LR
51	C→L<>R sl	pause at C then move slowly between LR
52	C→L<>R	pause at C then move between LR
53	C→L<>R fs	pause at C then move quickly between LR
54	LFO MWheel	controller regulates the width (initially 0) of LFO panning
55	LFO wide	broad panning by LFO
56	Note wide	broad panning by note number
57	Note narrow	narrow panning by note number
58	Note w+EG n	broad panning by note number + narrow LR movement
59	Noten+EG w	narrow panning by note number + broad LR movement
60	Vel wide	broad panning by key velocity
61	Vel narrow	narrow panning by key velocity
62	Vel w+EG n	broad panning by key velocity + narrow LR movement
63	R&L 1	variation of repeated LR movement
64	R&L 2	variation of repeated LR movement

COMMON DATA / ELEMENT DYNAMIC PAN

## 6.0 Dynamic pan edit

**Summary:** This function allows you to edit the currently selected Dynamic Pan data.

**Procedure:**

From: Voice Common job 06.ElemPan  
(JUMP #207)

When: an Internal dynamic pan memory is selected

Press: F8 (Edit)

Select: the Dynamic Pan parameter you wish to edit

Editing is possible only when an Internal pan memory is selected. If you want to edit one of the preset pan memories, press COPY to copy it to an Internal pan memory as explained in the following section 6.0.1 Copy Pan Data.

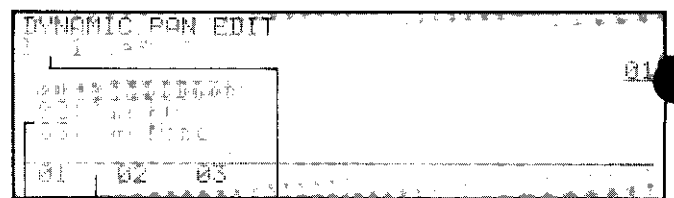

- ① The name and number of the currently selected Dynamic Pan data are displayed.
- ② Move the cursor in this area to select a job.
  - 01: Pan Source: Select a control source (velocity, note number, or LFO) to affect dynamic panning. (See 6.1 Pan Source)
  - 02: Pan EG: Set the panning EG. (See 6.2 Pan EG)
  - 03: Pan Name: Assign a ten-character name to the pan data. (See 6.3 Pan Name)
- ③ Pressing F1–F3 will select the corresponding job.



## 6.0.1 Copy pan data

**Summary:** This function copies dynamic pan data from another memory into an Internal pan data memory.

**Procedure:**

When: editing dynamic pan data

Press: COPY to get the following display.

Specify: the source and destination pan.

To copy: the pan data press F8.

To quit: without copying press EXIT.

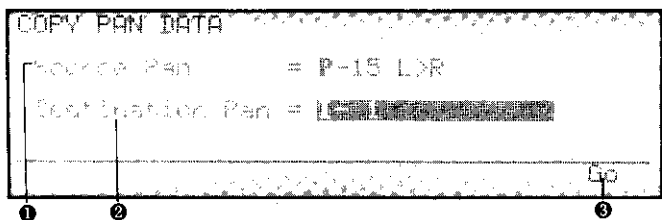

- ❶ Source Pan: Select the dynamic pan data to copy.
- ❷ Destination Pan: Select the dynamic pan data (internal 1–32) into which to copy the Source Pan data.
- ❸ After selecting Source Pan and Destination Pan, press F8 (Go) to copy the data. You will be asked “Are you sure?”. Press YES and the data will be copied.

**Remarks:** Only Internal Pan Data memories can be edited. If you want to edit one of the preset pan tables, use this function to copy it into an Internal pan memory.

## 6.1 Pan source

**Summary:** This determines how the dynamic panning will be affected; either by Velocity, or Note Number, or LFO.

**Procedure:**

From: Dynamic Pan Edit job directory

Select: 01:Pan Source

Specify: the pan source and depth

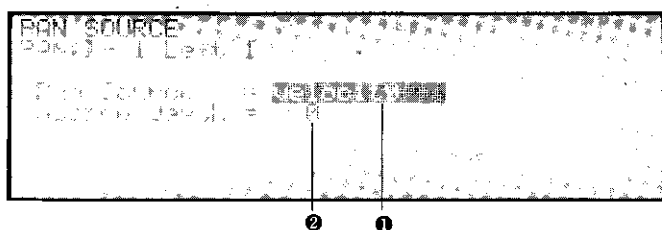

- ❶ Pan Source (Velocity, Key Note Number, LFO): Select the control source which will affect dynamic panning. When velocity is selected, the playing strength of each note will affect panning. When note number is selected, notes above middle C will be panned more to the right, and notes below middle C will be panned more to the left. When LFO is selected, the LFO of the element will continuously pan the sound.
- ❷ Source Depth (0...127): This determines how much the selected Pan Source will affect panning. When this is set to 0, the selected pan

source will have no effect. When this is set to 127, the selected pan source will pan the element over the range of full left to full right.

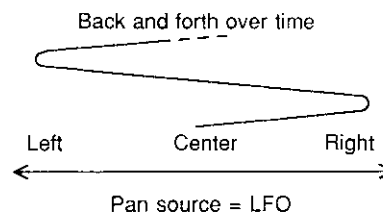
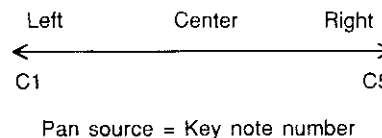
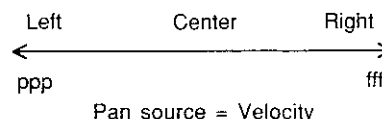

**Remarks:** Dynamic panning is controlled by two factors working together; the Pan Source and the Pan EG. Refer to the diagram in 6.2 Pan EG for an example of this.

## 6.2 Pan EG

**Summary:** Specify how the element will be panned over time, starting when each note is played.

**Procedure:**

From: Dynamic Pan Edit job directory

Select: 02:Pan EG.

Press: F1 (Rate) to set pan EG rates.

Press: F2 (Lvl) to set pan EG levels.

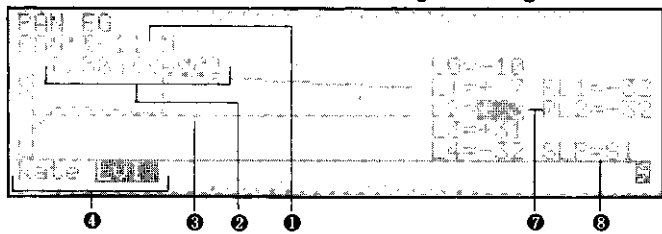
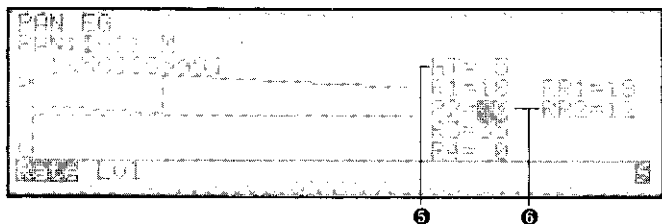

- 1 The number and name of the currently selected Dynamic Pan data are displayed.
- 2 This indicates the displayed segment and range of the EG graphic display. To change the range, hold SHIFT and press F1-F6 (x1, x2, x5, x10, x20, x50). To shift the EG graphic display to a different segment, hold SHIFT and press F7 or F8 to select Seg0-Seg4, Rel1.
- 3 The pan EG is graphically displayed.
- 4 Press F1 (Rate) to set EG rates. Press F2 (Lvl) to set EG levels.
- 5 HT (Keyon Delay Time 63...0): When this is set to 0, the pan EG will begin immediately after a key is pressed. For higher settings, there will be an increasingly longer delay before the pan EG begins.
- 6 R1-R4, RR1-RR2 (Keyon Rates, Release Rates 0...63): Keyon Rates 1-4 and Release Rates 1-2 determine the speed of the pan EG. Higher settings result in faster change. Refer to the following diagram.
- 7 L0-L4, RL1-2 (Keyon Levels, Release Levels -32...+32): Keyon Levels 0-4 and Release Levels 1-2 determine the panning direction and distance of the pan EG. Negative settings move left, and positive settings move right. Refer to the following diagram.

8 SLP (Loop Point S1-S4): This specifies the segment from which the EG will continue looping if a key remains depressed after the EG has come to the end. Refer to the following diagram.

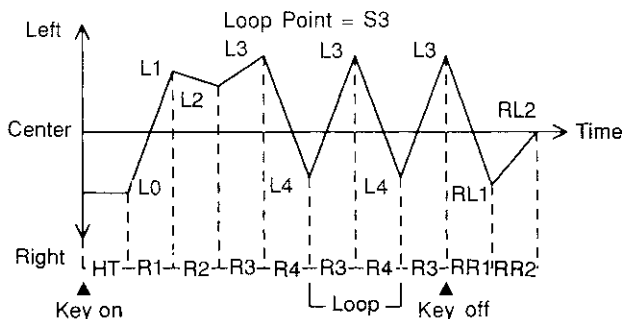
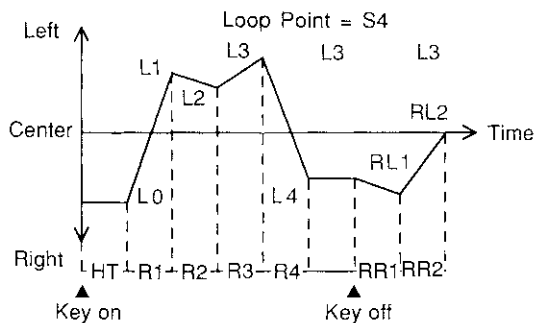

When you press a key, the sound will be output at the pan position of L0. When the specified hold time (HT) has elapsed, the pan position will change at the rate of R1 to level L1. When the pan position reaches L1, it will change at the rate of R2 to the position of L2. When the pan position reaches L2, it will change at the rate of R3 to the position of L3. When the pan position reaches L3, it will change at the rate of R4 to the position of L4. When the pan position reaches L4, the EG will begin looping from the specified segment (in the above diagram, SLP=S3).

When you release the key, the pan position will change at the rate of RR1 to the position of RL1. When the pan position reaches RL1, it will change at the rate of RR2 to the position of RL2.

**Remarks:** Hold Time (HT) is a *time* setting, but the various Rates are *speed*. Higher settings for Hold Time will result in a longer delay before the pan EG begins, but higher settings for Rates will result in faster change. The final result of the Pan EG will depend on the Pan Source settings.

COMMON DATA / ELEMENT DYNAMIC PAN

## 6.3 Pan name

**Summary:** Specify a ten-character name for the internal Pan data memory being edited.

**Procedure:**

- From: Dynamic Pan Edit job directory
- Select: 03:Pan Name
- Specify: a name for the pan memory

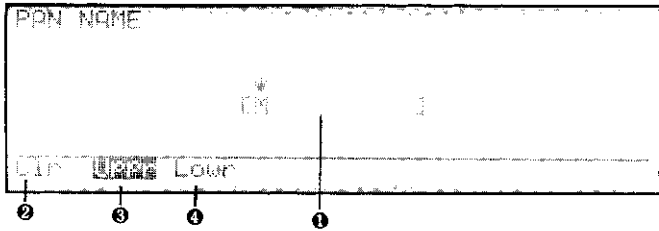

- 1 Enter a ten-character name for the Pan data.
- 2 To clear the currently entered name press F1 (Clr).
- 3 To switch to upper-case characters press F2 (Uppr).
- 4 To switch to lower-case characters press F3 (Lowr).

Methods of entering character data are explained in *Introducing the SY77, How to use the numeric key pad*, on page 00.

COMMON DATA

## 7. Output group select

JUMP #208

**Summary:** Specify the output group for each element.

**Procedure:**

- From: voice common job directory (JUMP #201)
- Select: job 07:OutSel (JUMP #208)
- Specify: the output group for each element

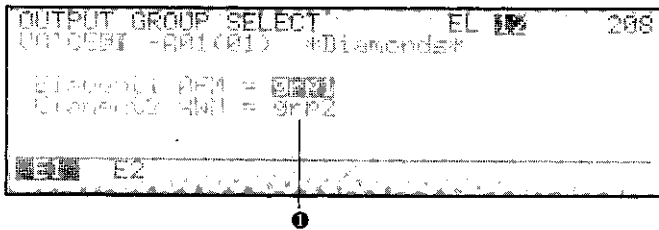

- 1 Element 1-4 (off, grp1, grp2, both): Each of the elements in a voice is independently panned by a

dynamic pan memory, and the stereo signal for each element is sent to the DSP effect units via Output Group 1 and/or 2. The selected Output Group(s) will determine how each element is processed through the effects units. (Refer to Voice Common data job 10.1 Effect Mode for details.) If output group is turned off, that element will not be heard.

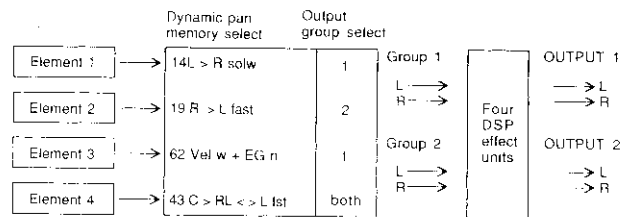

COMMON DATA

## 8. Random pitch

JUMP #209

**Summary:** Specify the amount of random pitch variation for the voice.

**Procedure:**

- From: voice common job directory (JUMP #201)
- Select: job 08:Random (JUMP #209)
- Specify: the amount of random pitch variation

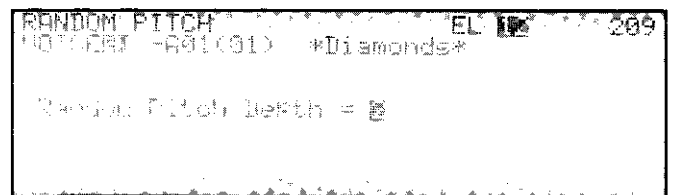

- ① **Random Pitch Depth (0...7):** For a setting of 0, a key will produce the same pitch each time it is pressed. For settings of 1...7, a key will produce a random deviation in pitch. Higher settings result in greater deviation from the standard key pitch.

**Remarks:** This parameter is helpful when simulating instruments which have a naturally unsteady pitch.

The random pitch deviation is applied separately to each element in the voice, meaning that pitch differences may appear between elements.

COMMON DATA

## 9. Portamento

JUMP #210

**Summary:** Specify the Portamento mode and time. Portamento creates a smooth glide in pitch between one note and the next.

**Procedure:**  
 From: voice common job directory (JUMP #201)  
 Select: job 09:Porta (JUMP #210)  
 Specify: the portamento mode and time

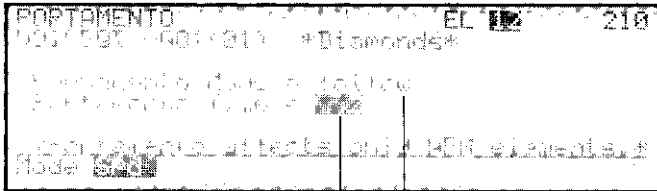

- ① **Portamento Mode:** If the currently selected voice mode is polyphonic (voice modes 4–10), the portamento mode is fixed at Follow mode. If the currently selected voice mode is monophonic (voice modes 1–3), the portamento mode can be set either to Fingered or Fulltime.

**Fingered portamento:** Portamento is applied only if you press a note before releasing the previous one; i.e., when you play legato.

**Full Time portamento:** Portamento is applied between all notes.

- ② **Portamento Time (0...127):** This determines the time of the pitch glide between notes. Higher settings result in a longer (slower) glide.

**Remarks:** If you do not want portamento, set Portamento Time to 0 so that the pitch change between notes is instantaneous.

As noted in the display, portamento applies only to AFM elements. It will have no effect on voices which use only AWM elements (voice modes 6–8). If a voice uses both AFM and AWM elements (voice modes 9 and 10), portamento will apply only to the AFM elements in the voice.

COMMON DATA

## 10. Effect set

JUMP #211

**Summary:** Specify how the effects units are connected, select an effect type for each unit, and make settings for each effect.

**Procedure:**  
 From: voice common job directory (JUMP #201)  
 Select: job 10:Effect (JUMP #211)  
 Select: the effect parameter you wish to edit



- ① Move the cursor in this area to select a job.
  - 01: Effect Mode Select: Specify how the four effect units will be connected. See 10.1 Effect Mode Select.
  - 02: Modulation Effect 1 Set: Select an effect type and set parameters for modulation effect 1. See 10.2 Modulation Effect 1 Set.
  - 03: Modulation Effect 2 Set: Select an effect type and set parameters for modulation effect 2. This is set in exactly the same way as explained for Modulation Effect 1. See 10.2 Modulation Effect 1 Set.

04: Reverb Effect 1 Set: Select an effect type and set parameters for reverb effect 1. See 10.4 (F1) Reverb effect 1 set.

05: Reverb Effect 2 Set: Select an effect type and set parameters for reverb effect 2. This is set in exactly the same way as Reverb Effect 1. See 10.4 (F1) Reverb effect 2 set.

② Pressing F1–F5 will select the corresponding job.

COMMON DATA / EFFECT SET

## 10.1 Effect mode select

JUMP #212

**Summary:** This determines how the four effects will be arranged to process the sound from the two stereo groups 1 and 2.

**Procedure:**

From: Effect Set job directory (JUMP #201)

Select: 01:Effect Mode Select (JUMP #212)

Specify: the effect mode

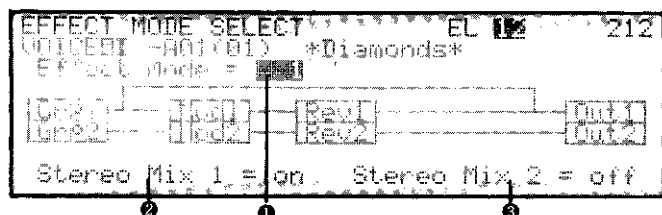

① Effect Mode (off, 1, 2, 3): This determines how the four effects will be arranged to process the sound from the two stereo groups 1 and 2. The effect mode will be graphically shown in the display.

When the Effect Mode is Off, the stereo groups 1 and 2 will be sent directly to output groups 1 and 2 without passing through the effect units.

When an Effect Mode of 1, 2, or 3 is selected, the stereo groups 1 and 2 will be processed through the effect units as shown in the following diagram.

② Stereo Mix 1 (off, on): When this is turned on, the unprocessed sound from group 1 will be added to the processed sound sent from output group 1.

③ Stereo Mix 2 (off, on): When this is turned on, the unprocessed sound from group 2 will be added to the processed sound sent from output group 2. If effect mode 3 is selected, the Stereo Mix 2 cannot be set.

effect mode off

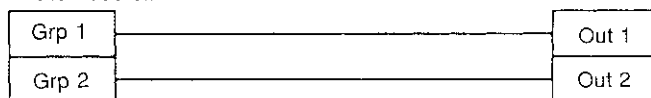

effect mode 1

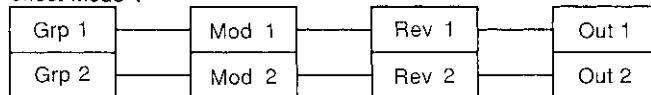

effect mode 2

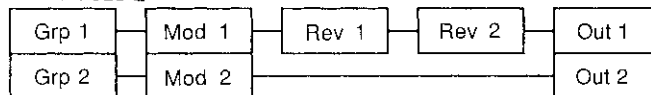

effect mode 3

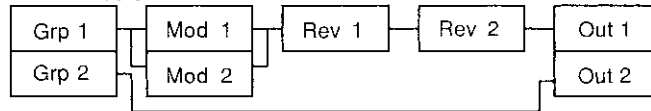

**Remarks:**

- The settings in *Voice Common data 7. Output group select* (JUMP #208) will determine whether each element of the voice is sent to Group 1 or Group 2.
- All modulation effects are stereo-in stereo-out. Reverb effects 35–40 are also stereo-in stereo-out. Reverb effects 1–34 are mono-in stereo-out, and the incoming stereo signal to each effect unit is combined into a mono signal before it is processed.
- Effect Mode 3 is an exception. Only the Lch output of modulation effect 1 and the Rch output of modulation effect 2 will be used for the Reverb effect 1 input.
- If you want the Dynamic Pan to be heard when using reverb effects 1–34, you must turn the Stereo Mix on to allow the direct stereo signal from the element pan to be combined with the output from the effect units.

The following sections 10.2–10.5 explain how to make settings for the four effect units.

COMMON DATA / EFFECT SET

## 10.1.1 Copy voice effect

**Summary:** This function copies Effect data from another voice into the effect data of the currently edited voice.

**Procedure:**

- When: editing Effect data (jobs 10.1–10.5)
- Press: COPY to get the following display.
- Specify: the voice from which to copy the effect data
- To copy: the data press F8
- To quit: without copying press EXIT

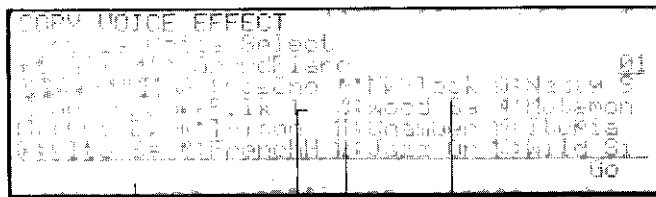

- 1 Use the voice memory buttons, bank buttons A–D, and voice memory buttons 1–16 to select a source voice from which to copy the Effect data.
- 2 Press F8 (Go) and you will be asked “Are you sure?”. If you are sure you want to copy the effect data, press YES and the effect data will be copied from the selected voice to the voice being edited.

COMMON DATA / EFFECT SET

## 10.2 (F1) Modulation effect 1 set (Data)

JUMP #213

**Summary:** Select an effect type for modulation effect 1, and set the effect balance and output level. This explanation also applies to modulation effect 2.

**Procedure:**

- From: Effect Set job directory (JUMP #211)
- Select: 02:Modulation Effect 1 Set
- Press: F1 (Data) (JUMP #213)
- Specify: the effect type, effect balance, and output level

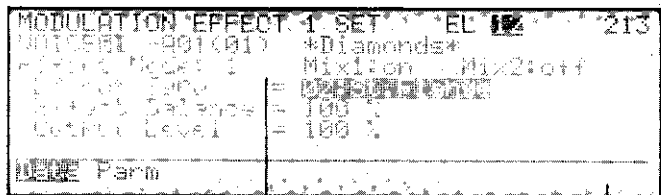

- 1 Effect Type: Four types of effect can be selected for the modulation effect unit. Refer to the list of modulation-type effects in the following section 10.2 (F2).
- 2 Effect Balance (0...100%): This determines the balance of processed and unprocessed sound. At a setting of 0% the output of the effect unit will be only unprocessed sound, and at a setting of 100% the output of the effect unit will be only processed sound.

- 3 Output Level (0...100%): This determines the volume level of the effect output. At a setting of 0% the effect unit will output no sound, and at a setting of 100% the output of the effect unit will be at full volume.
- 4 To set the parameters of the selected Effect Type, press F2 (Parm). (See the following section 10.2 (F2).)

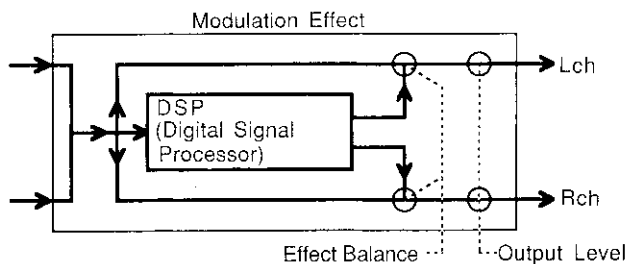

**Remarks:** All modulation effects are stereo-in stereo-out.

*Note:* Changing the Effect Type will initialize the Parameter settings of F2 (Parm).

COMMON DATA / EFFECT SET

## 10.2 (F2) Modulation effect 1 set (Parameters)

JUMP #214

**Summary:** Set effect parameters of the effect type selected for modulation effect 1. This explanation also applies to modulation effect 2.

**Procedure:**

From: Effect Set job directory (JUMP #211)

Select: 02:Modulation Effect 1 Set

Press: F2 (Parm) (JUMP #214)

Specify: parameter settings for the selected effect

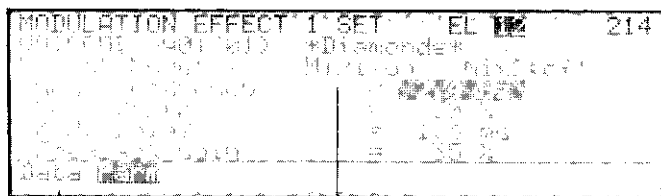

- ① The number and type of effect parameters will depend on the selected Effect Type. Refer to the following parameter lists for each effect type. Through has no parameters.
- ② To select an Effect Type and set Effect Balance and Output level, press F1 (Data). (See the previous section 10.2 (F1).)

**Note:** Changing the Effect type in F1 (Data) will initialize these Parameter settings.

Through: The input sound will be output without any processing.

1:St.Chorus (stereo chorus)

Modulation Frequency (0.2...20.0 Hz)

Pitch Mod. Depth (0...100%)

Amplitude Modulation Depth (0...100%)

2:St.Flange (stereo flanger)

Modulation Frequency (0.2...20 Hz)

Modulation Depth (0...100%)

Modulation Delay Time (0.2...15 ms)

Feed Back Gain (0...99%)

3:Symphonic

Modulation Frequency (0.2...20 Hz)

Modulation Depth (0...100%)

4:Tremolo

Modulation Frequency (0.2...20 Hz)

Modulation Depth (0...100%)

Phase (-8...+8)

**Modulation effect parameters:** The parameters of the modulation effects are explained below in alphabetical order.

**Amplitude Modulation Depth:** The amount of tremolo; i.e., cyclical change in volume.

**Feedback Gain:** For effects with very short delays such as 2.St.Flange, this will adjust the character of the effect.

**Modulation Depth:** The depth of the cyclical change.

**Modulation Delay Time:** For effects with very short delays such as 2.St.Flange, this will adjust the character of the effect.

**Modulation Frequency:** The speed of the cyclical change; i.e., the speed of chorusing, flanging, etc.

**Pitch Modulation Depth:** The amount of vibrato; i.e., cyclical change in pitch.

**Phase:** The phase of the pitch shifted signal.

COMMON DATA / EFFECT SET

## 10.4 (F1) Reverb effect 1 set (Data)

JUMP #217

**Summary:** Select an effect type for Reverb effect 1, and set the effect balance and output level. This explanation also applies to reverb effect 2.

**Procedure:**

From: Effect Set job directory (JUMP #211)

Select: 04:Reverb Effect 1 Set

Press: F1 (Data) (JUMP #217)

Specify: the effect type, effect balance, and output level

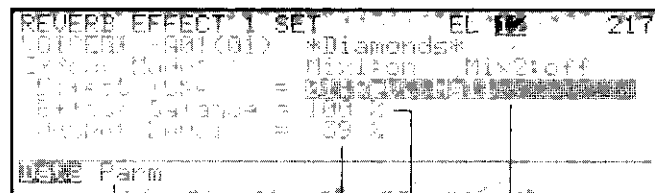

## VOICE EDIT MODE

- ① **Effect Type:** Forty types of effects can be selected for the reverb effect unit. Refer to the list of reverb-type effects in the following section 10.4 (F2).
- ② **Effect Balance (0...100%):** This determines the balance of processed and unprocessed sound. At a setting of 0% the output of the effect unit will be only unprocessed sound, and at a setting of 100% the output of the effect unit will be only processed sound.
- ③ **Output Level (0...100%):** This determines the volume level of the effect output. At a setting of 0% the effect unit will output no sound, and at a setting of 100% the output of the effect unit will be at full volume.
- ④ To set the parameters of the selected Effect Type, press F2 (Parm). (See the following section 10.4 (F2).)

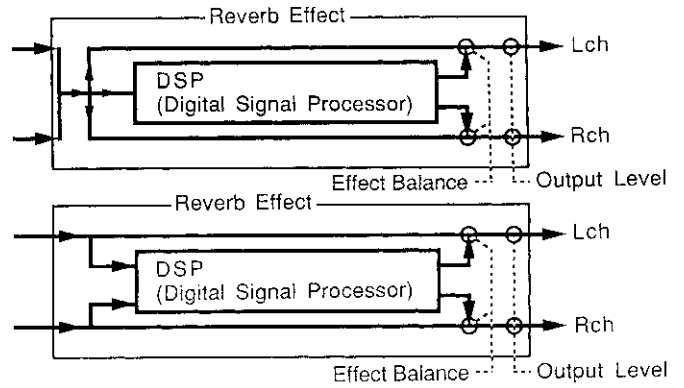

**Remarks:** Reverb effects 1:Rev.Hall to 34:Distortion are mono-in stereo-out. In other words, the incoming stereo signal from the element Dynamic Pan is combined into a mono signal and processed to create a stereo effect. Reverb effects 35:Ind.Delay to 40:Ind.Rev&Delay are stereo-in stereo-out, with independently settable parameters for left and right.

*Note: Changing the Effect Type will initialize the Parameter settings of F2 (Parm).*

### COMMON DATA / EFFECT SET

## 10.4 (F2) Reverb effect 1 set (Parameters)

JUMP #218

**Summary:** Set effect parameters of the effect type selected for reverb effect 1. This explanation also applies to reverb effect 2.

#### Procedure:

- From: Effect Set job directory (JUMP #211)  
 Select: 04:Modulation Effect 1 Set  
 Press: F2 (Parm) (JUMP #218)  
 Specify: parameter settings for the selected effect

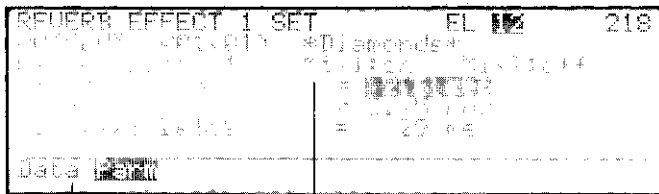

- ① The number and type of effect parameters will depend on the selected Effect Type. Refer to the following parameter lists for each effect type. 00:Off(Through) has no parameters.
- ② To select an Effect Type and set Effect Balance and Output level, press F1 (Data). (See the previous section 10.4 (F1).)

*Note: Changing the Effect Type in F1 (Data) will initialize these Parameter settings.*

- 1:Reverb Hall, 2:Reverb Room, 3:Reverb Plate, 4:Reverb Church, 5:Reverb Club, 6:Reverb Stage, 7:Reverb Bath Room, 8:Reverb Metal**  
 Reverb Time (0.3...10.0 sec)  
 L.P.F. (1.25...12 KHz, Through)  
 Initial Delay (0.1...50 ms)

#### 9:Single Delay

- Delay Time (0.1...300 ms)  
 FB Delay Time (0.1...300 ms)  
 Feedback Gain (0...99%)

#### 10:Delay L,R,

- Lch Delay Time (0.1...300 ms)  
 Rch Delay Time (0.1...300 ms)  
 Feedback Gain (0...99%)

#### 11:Stereo Echo

- Lch Delay Time (0.1...152 ms)  
 Rch Delay Time (0.1...152 ms)  
 Feedback Gain (0...99%)

#### 12:Doubler 1

- Delay Time (0.1...50 ms)  
 H.P.F. (Thru, 160...1000 Hz)  
 L.P.F. (1.25...12 KHz, Thru)



**13:Doubler 2**

Lch Delay Time (0.1...50 ms)  
 Rch Delay Time (0.1...50 ms)  
 L.P.F. (1.25...12 KHz, Thru)

**14:Ping-Pong Echo**

Delay Time (0.1...152 ms)  
 Pre-Delay Time (0.1...152 ms)  
 Feedback Gain (0...99%)

**15:Pan Reflection**

Room Size (0.5...3.2)  
 Feedback Gain (0...99%)  
 Direction (L→R, L←R)

**16:Early Reflection, 17:Gate Reverb, 18:Reverse Gate**

Room Size (0.5...3.2)  
 L.P.F. (1.25...12 KHz, Thru)  
 Initial Delay (0.1...50 ms)

**19:Feedback Early Reflection, 20:Feedback Gate, 21:Feedback Reverse**

Room Size (0.5...3.2)  
 L.P.F. (1.25...12 KHz, Thru)  
 Feedback Gain (0...99%)

**22:Single Delay & Reverb**

Reverb Time (0.3...10.0 sec)  
 Delay Time (0.1...152 ms)  
 Feedback Gain (0...99%)

**23: Delay L/R & Reverb**

Reverb Time (0.3...10.0 sec)  
 Lch Delay Time (0.1...152 ms)  
 Rch Delay Time (0.1...152 ms)

**24:Tunnel Reverb**

Reverb Time (0.3...10.0 sec)  
 Delay Time (0.1...152 ms)  
 Feedback Gain (0...99%)

**25:Tone Control 1**

Low Gain (-12...+12 dB at 800 Hz)  
 Mid Gain (-12...+12 dB at 1260 Hz)  
 High Gain (-12...+12 dB at 3KHz)

**26:Single Delay + Tone Control 1,****27:Delay L/R + Tone Control 1**

Brilliance (0...12)  
 Delay Time (0.1...300 ms)  
 Feedback Gain (0...99%)

**28:Tone Control 2**

H.P.F (Thru, 160...1000 Hz)  
 Mid Gain (-12...+12 dB at 1260 Hz)  
 L.P.F. (1.25...12 KHz, Thru)

**29:Single Delay + Tone Control 2,****30:Delay L/R + Tone Control 2**

Brilliance (0...12)  
 Delay Time (0.1...300 ms)  
 Feedback Gain (0...99%)

**31:Distortion + Reverb**

Reverb Time (0.3...10.0 sec)  
 Distortion Level (0...100%)  
 Dist & Rev Balance (0...100%)

**32:Distortion + Single Delay,****33:Distortion + Delay L/R**

Delay Time (0.1...300 ms)  
 Feedback Gain (0...99%)  
 Distortion Level (0...100%)

**34:Distortion**

Distortion Level (0...100%)  
 H.P.F. (Thru, 160...1000 Hz)  
 L.P.F. (1.25...12 KHz, Thru)

**35:Ind. Delay**

Lch Delay Time (0.1...152 ms)  
 Rch Delay Time (0.1...152 ms)  
 Feedback Gain (0...99%)

**36:Ind. Tone Control**

Lch Brilliance (0...12)  
 Rch Brilliance (0...12)  
 Mid Gain (-12...+12 dB at 1260 Hz)

**37:Ind. Distortion**

Lch Dist. Level (0...100%)  
 Rch Dist. Level (0...100%)  
 L.P.F. (1.25...12 KHz, Thru)

**38:Ind. Reverb**

Lch Reverb Time (0.3...10.0 sec)  
 Rch Reverb Time (0.3...10.0 sec)  
 High Control (0.1...1.0)

**39:Ind. Delay & Reverb**

Lch Delay Time (0.1...152 ms)  
 Lch Feedback Gain (0...99%)  
 Rch Reverb Time (0.3...10.0 sec)

## VOICE EDIT MODE

### 40:Ind. Reverb & Delay

Lch Reverb Time (0.3...10.0 sec)

Rch Delay Time (0.1...152 ms)

Rch Feedback Gain (0...99%)

**Reverb effect parameters:** The parameters of the reverb effects are explained below in alphabetical order.

**Brilliance:** the overall brightness of the sound

**Delay Time:** the delay before the echoed sound

**Direction:** the direction in which the echoes will be panned

**Dist & Rev Balance:** the balance between distortion and reverb

**Distortion Level:** the amount of the distorted sound

**FB Delay Time:** the delay between repeated echoes of the sound

**Feedback Gain:** the volume ratio of each echo to the previous one

**H.P.F.:** frequencies higher than this will be allowed to pass

**High Control:** the proportion at which high frequency reverb will decay

**High Gain:** the amount of boost or cut at 3 KHz

**Initial Delay:** the delay before the effect processed sound will be heard

**L.P.F.:** frequencies lower than this will be allowed to pass

**Lch Brilliance:** the overall brightness of the left channel

**Lch Delay Time:** the delay between repeated echoes in the left channel

**Lch Dist. Level:** the amount of distortion for the left channel

**Lch Feedback Gain:** the volume ratio of each successive left channel echo

**Lch Reverb Time:** the time for the left channel reverb to decrease 60 dB

**Low Gain:** the amount of boost or cut at 800 Hz

**Mid Gain:** the amount of boost or cut at 1260 Hz

**Pre-Delay Time:** the time delay before reverb will begin

**Rch Brilliance:** the overall brightness of the right channel

**Rch Delay Time:** the delay between repeated echoes in the right channel

**Rch Dist. Level:** the amount of distortion for the right channel

**Rch Feedback Gain:** the volume ratio of each successive right channel echo

**Rch Reverb Time:** the time for the right channel reverb to decrease 60 dB

**Reverb Time:** the time for the reverb to decrease 60 dB

**Room Size:** the size (in arbitrary units) of the reverberant room

COMMON DATA

## 11. Micro tuning

JUMP #221

**Summary:** Select a micro tuning for the entire voice, and specify whether or not each element will use this micro tuning.

### Procedure:

From: Voice Common job (JUMP #201)  
directory

Select: job 11:Mcrtune (JUMP #221)

Specify: the micro tuning, and element micro tuning on/off



- 1 Micro Tuning Select (I-1, I-2, C-1, C-2, P-1... P-64): Select a micro tuning to be used by the voice. 64 micro tuning memories are preset inside the SY77 (see the following remarks). Two of your own micro tunings can be stored in Internal memory, and a card can accommodate another two micro tunings. Internal voices cannot use card micro tunings, nor can card voices use internal micro tunings.
- 2 Element 1-4 (off, on): When this is turned on, the element will use the micro tuning selected by Micro Tuning Select. When this is turned off, the element will use equal temperament scale instead of the selected micro tuning.

- ③ Pressing F1 (Sel) will move the cursor to Micro Tuning Select. Pressing F2–F5 will move the cursor to Element 1–4.

**Remarks:** As with Pan data, Micro Tuning data is not part of the voice. This Micro Tuning Select setting merely specifies which micro tuning will be used.

The sixty four micro tunings preset inside the SY77 are as follows.

**01 Equal temperament:** The “compromise” tuning used for most of the last 200 years of Western music, and found on most electronic keyboards. Each half step is exactly 1/12th of an octave, and music can be played in any key with equal ease. However, none of the intervals are perfectly in tune.

**02–13 Pure major (C...B):** This tuning is designed so that most of the intervals (especially the major third and perfect fifth) in the major scale are pure. This means that other intervals will be correspondingly out of tune. You need to specify the key (C...B) you will be playing in.

**14–25 Pure minor (A...G#):** The same as Pure Major, but designed for the minor scale.

**26–37 Mean tone (C...B):** This is an adjustment of the Pure and Pythagorean tunings. The interval between the root and fifth is tuned slightly flat, so that the interval between the root and second degree is exactly halfway between a major and minor pure second; i.e., an average or “mean”.

**38–49 Pythagorean (C...B):** This scale is derived by tuning pure perfect fifths upward from the root. This causes the octave to be flat, so one of the fourths is mistuned to compensate. (In the key of C, the Ab – Eb interval.)

**50 Werckmeister:** Andreas Werckmeister, a contemporary of Bach, designed this tuning so that keyboard instruments could be played in any key. Each key has a unique character.

**51 Kirnberger:** Johan Philipp Kirnberger was also concerned with tempering the scale to allow performances in any key.

**52 Vallotti & Young:** Francescantonio Vallotti and Thomas Young (both mid-1700s) devised this adjustment to the Pythagorean tuning in which the first six fifths are lower by the same amount.

**53 1/4 shifted equal:** This is the normal equal tempered scale shifted up 50 cents.

**54 1/4 tone:** Twenty-four equally spaced notes per octave. (Play twenty-four notes to move one octave.)

**55 1/8 tone:** Forty-eight equally spaced notes per octave. (Play forty-eight notes to move one octave.)

**56 JustAdjust:** This is a special tuning used in preset voice P1-B05 Chorus Pno to make fine adjustments in the pitch of the AWM waveform.

**57 Big Chord:** The pitch is adjusted down one octave for every 8 half notes, allowing chords to be played anywhere without becoming overly heavy. This microtuning is taken advantage of in preset voice P1-B06 BigChordEP.

**58 Log Equal:** A variation of conventional equal temperament.

**59 1/4 Tonelo:** The same as micro tuning 54, but lower in pitch.

**60 Harmonic A:** The white keys will play the harmonic series beginning on A, and the black keys will play the harmonic series beginning on E.

**61 Reverse:** The conventional equal tempered scale is inverted.

**62 Far East:** The black keys and white keys will each play a different eastern scale.

**63 Blue:** The white keys will play the blues scale. The black keys add a blue flavor

**64 Question-1:** Play the white keys consecutively upwards starting from C2.

Play the black keys consecutively upwards starting from C#1.

**Editing:** To edit the currently selected Internal micro tuning, press F8 (Edit). Preset or Card micro tunings cannot be edited. If you want to edit a preset or card micro tuning, you must first copy it to an internal micro tuning memory.

COMMON DATA / MICRO TUNING SET

## 11.0 Micro tuning edit

JUMP #222

**Summary:** This function allows you to edit the currently selected Micro Tuning data.

**Procedure:**

From: Voice Common job 11. Micro Tuning Set (JUMP #221)

When: an Internal micro tuning is selected

Press: F8 (Edit) (JUMP #222)

Select: the micro tuning data you wish to edit

Editing is possible only when an Internal micro tuning memory is selected. If you want to edit a Preset or Card micro tuning memory, press COPY to copy it to an Internal micro tuning memory as explained in the following section 11.0.1 Copy Micro Tuning Data.

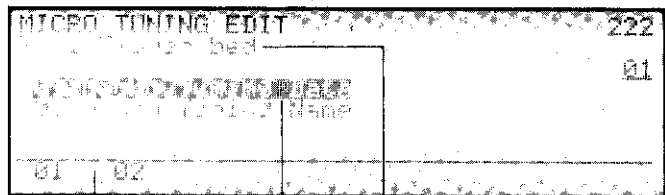

- ❶ The number and name of the currently selected Micro Tuning data are displayed.
- ❷ Move the cursor in this area to select a job, and press ENTER.  
01: Micro Tuning Data: Edit the tuning for each note of the scale. See 11.1 Micro Tuning Data  
02: Micro Tuning Name: Assign a ten-character name to the micro tuning data. See 11.2 Micro Tuning Name.
- ❸ Pressing F1 or F2 will select the corresponding job.

COMMON DATA / MICRO TUNING SET

## 11.0.1 Copy micro tuning

**Summary:** This function copies micro tuning data from another memory into an Internal micro tuning memory.

**Procedure:**

When: editing micro tuning data (JUMP #223, #224)

Press: COPY to get the following display.

Select: the micro tuning copy source and destination

To copy: the data press F8

To quit: without copying press EXIT

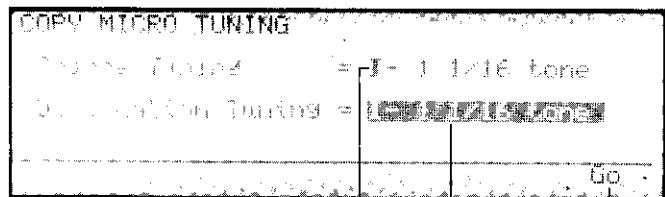

- ❶ Source Tuning (I-1, I-2, C-1, C-2, P-1...P-64): Select the micro tuning data to copy. C-1 and C-2 (card) can be selected only if a VOICE card is
- ❷ Destination Tuning (I-1, I-2): Select the micro tuning (internal 1 or 2) into which to copy the Source Tuning data.
- ❸ After selecting Source Tuning and Destination Tuning, press F8 (Go) to copy the data. You will be asked "Are you sure?". Press YES and the data will be copied.

**Remarks:** Only Internal micro tuning data can be edited. If you want to edit one of the preset or card micro tunings, use this function to copy it into an Internal micro tuning memory.

COMMON DATA / MICRO TUNING SET

## 11.1 Micro tuning data

JUMP #223

**Summary:** Edit the tuning for each note of the selected micro tuning data.

**Procedure:**

- From: Micro Tuning Edit job (JUMP #222)  
 directory  
 Select: 01:Micro Tuning Data (JUMP #223)  
 Specify: the tuning for each note

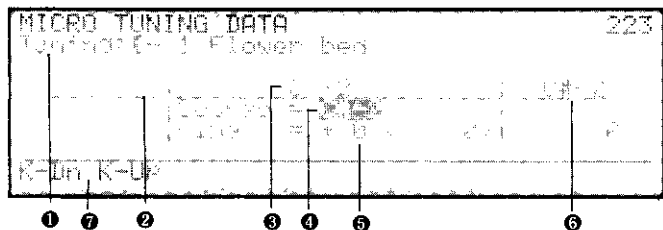

- ❶ The number and name of the micro tuning data being edited are displayed.
- ❷ The previous note and its absolute tuning value.
- ❸ The note whose tuning you are editing.
- ❹ Coarse Tuning (C#-1...G8): With the cursor located at Coarse, adjust the tuning of the currently edited note in half steps.
- ❺ Fine Tuning (-43 or -42...+42): With the cursor located at Fine, adjust the tuning of the currently edited note in fine steps of 1.171875 cents. The

absolute tuning value displayed in parentheses indicates the number of these steps starting from 0 steps at C#-2. The lowest setting of this parameter will be either -43 or -42 depending on the Coarse Tuning value.

- ❻ The next note name and its absolute tuning value.
- ❼ Pressing F1 (K-Dn) or F2 (K-Up) will move to the previous or next note. You can also play a note on the keyboard to select a note at any time.

**Remarks:** First use F1 (K-Dn) and F2 (K-Up) to select the note whose tuning you want to edit. You can also use the SY77 keyboard to select the note. The currently edited note will appear in the center of the display, with the previous note shown at left and the next note shown at right. Next set the Coarse and Tune tuning for the selected note. If you adjust Fine Tuning beyond the range of  $\pm 42$ , the Coarse Tuning will be moved up or down as appropriate.

COMMON DATA / MICRO TUNING SET

## 11.2 Micro tuning name

JUMP #224

**Summary:** Specify a ten-character name for the internal Micro Tuning memory being edited.

**Procedure:**

- From: Micro Tuning Edit job (JUMP #222)  
 directory  
 Select: 02:Micro Tuning Name (JUMP #224)  
 Specify: a name for the micro tuning data

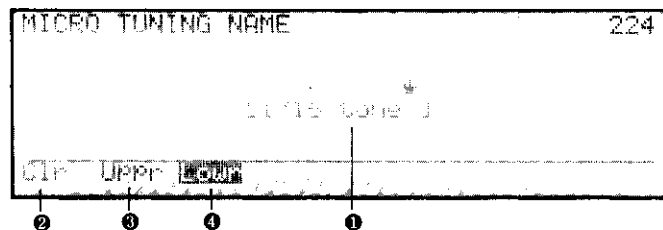

- ❶ Enter a ten-character name for the Micro Tuning data.
- ❷ To clear the currently entered name press F1 (Clr).
- ❸ To switch to upper-case characters press F2 (Uppr).
- ❹ To switch to lower-case characters press F3 (Lowr).

**Remarks:** Methods of entering character data are explained in *Introducing the SY77, How to use the numeric key pad*, on page 30.

COMMON DATA

## 12. (F1) Controller set (Pitch bend)

JUMP #225

**Summary:** Specify the range over which the PITCH wheel and After Touch will affect the pitch.

**Procedure:**

From: Common Data job directory (JUMP #201)

Select: job 12:CtrlRr

Press: F1 (PB) (JUMP #225)

Specify: the pitch bend effect of the PITCH wheel and aftertouch

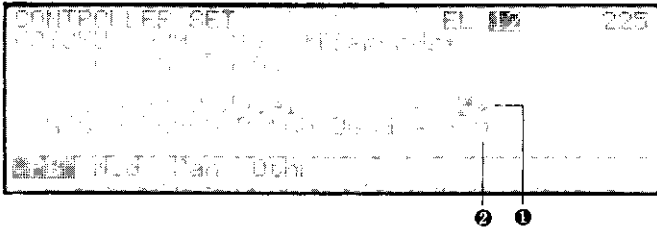

- ❶ Pitch Bend Wheel (0...12): This determines the range (0...12 half steps) over which the PITCH wheel will affect the pitch. When this is set to 12, the PITCH wheel will move the pitch one octave up or down. When this is set to 0, the PITCH wheel will have no effect.
- ❷ After Touch Pitch Bend (-12...+12): This determines how aftertouch will affect the pitch. Pressing strongly down on the keyboard after playing a note will move the pitch down one octave (with a maximum setting of -12) and up one octave (with a maximum setting of +12).

COMMON DATA

## 12. (F2) Controller set (Modulation)

JUMP #226

**Summary:** Specify the controller device that will add vibrato (pitch modulation), tremolo (amplitude modulation), and wah-wah (filter modulation).

**Procedure:**

From: Common Data job directory (JUMP #201)

Select: job 12:CtrlRr

Press: F2 (Mod) (JUMP #226)

Specify: the controller and depth for each parameter

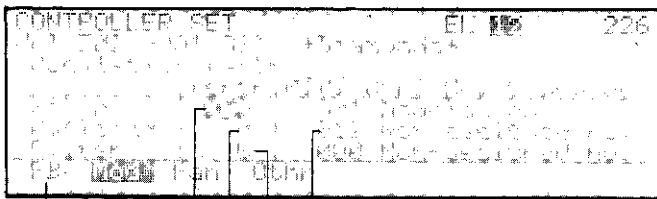

- ❶ Pitch Modulation Depth (0...127): This setting determines the range over which the specified device will add vibrato (pitch modulation). For a setting of 127, the selected controller will be able to add the maximum amount of vibrato. For a setting of 0, the selected controller will not be able to add vibrato.
- ❷ Amplitude Modulation Depth (0...127): This setting determines the range over which the specified device will add tremolo (amplitude modulation). Details are the same as in ❶.

- ❸ Filter Modulation Depth (0...127): This setting determines the range over which the specified device will add wah-wah (filter modulation). Details are the same as in ❶.
- ❹ MIDI Ctrl No. & Device (0...120, After Touch): These settings determine the controller devices that will add Pitch modulation, Amplitude modulation, and Filter modulation. The selected MIDI control number (0...120) is displayed at left, and the function which is defined for that number is displayed at right.
- ❺ To make controller settings for Pitch Bend, Pan, or Other, press F1, F3, or F4. Refer to sections 12.(F1), 12.(F3), or 12.(F4).

**Remarks:** As shown by the following diagram, the controllers selected here will be able to *add* pitch, amplitude, and filter modulation *in addition to* the pitch, amplitude, and filter modulation specified by the PModDepth, AModDepth, and FModDepth settings of each element LFO. The effect of the resulting modulation will depend on the *sensitivity* settings of each element.

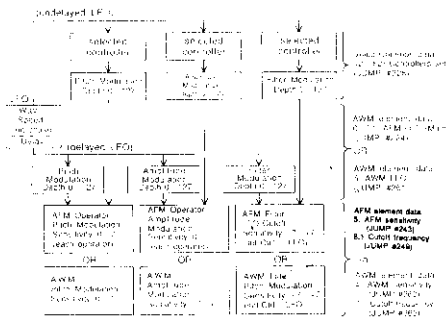

**Fixed controllers:** The control numbers transmitted by the following four controllers built into the SY77 are fixed, and cannot be changed. When these controllers are moved, they will transmit MIDI control messages of the corresponding number. When the following control numbers are selected, these built-in controllers will regulate the assigned function. The official MIDI standard defines Aftertouch not as a control number but as a different type of message, so it is not given a control number.

- 001: The MODULATION 1 wheel located at the left of the keyboard
- 002: An optional breath controller connected to the rear panel BREATH jack
- 004: An optional foot controller connected to the rear panel FOOT CONTROLLER jack
- Aftertouch: (i.e., pressing down on the keyboard after playing a note)

**Assignable controllers:** In addition to these four controllers whose function is fixed, the SY77 has the following two assignable controllers. With the factory settings, the MODULATION 2 wheel is assigned MIDI control number 13, and the FOOT SWITCH is assigned control number 65. The con-

trol number transmitted by these controllers can be changed by the setting in *Utility mode System Utility 3. Controllers (JUMP #803)*.

- The MODULATION 2 wheel located at the left of the keyboard (initially set to transmit control number 013:Non-assigned)
- An optional foot switch connected to the rear panel FOOT SWITCH jack (initially set to transmit control number 065:Portamento Switch)

**MIDI controllers:** The specified MIDI Ctrl No.& Device applies both to the built-in controllers of the SY77 and to incoming MIDI control data received at MIDI IN. For example if you have specified that Amplitude Modulation Depth be regulated by 001:Modulation Wheel, it will be regulated by incoming MIDI Control Change 001 messages in addition to movements of the SY77's own MODULATION 1 wheel.

The official MIDI standard does not define the purpose of all of the MIDI Control Change messages 0–120. If the selected control number has not been defined, the LCD will show “Non-assigned no.”. You can use these control numbers just like any other control number. For example you might assign an assignable controller (see *Utility mode System Utility 3. Controllers*) to one of these numbers, and then select that control number to regulate Pitch Modulation depth. “Non-assigned no.” simply means that there is no official agreement as to the use of that control number.

COMMON DATA

## 12. (F3) Controller set (Pan)

JUMP #227

**Summary:** Specify the controller device that will regulate the depth of the cyclical panning movement (Pan LFO), and the controller that will directly adjust the pan position (Pan Bias).

**Procedure:**

- From: Voice Common job directory (JUMP #201)
- Select: job 12:CtrlR
- Press: F3 (Pan) (JUMP #227)
- Specify: the controller and depth for each parameter

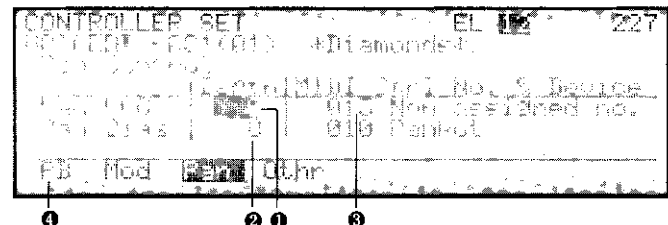

## VOICE EDIT MODE

- 1 Pan LFO Depth (0...127): This determines the range over which the specified controller will regulate the depth of the Pan LFO. When this is set to 127, the selected controller will regulate LFO panning over the full range from no LFO panning to maximum LFO panning. When this is set to 0, the selected controller will have no effect on LFO panning.
- 2 Pan Bias Depth (0...127): This determines the range over which the specified controller will affect pan position.
- 3 MIDI Ctrl No. & Device (0...120, After Touch): These settings determine which controllers will regulate the depth of LFO panning and Pan Bias.
- 4 To make controller settings for Pitch Bend, Modulation, or Other, press F1, F2, or F4. Refer to sections 12. (F1), 12. (F2), or 12. (F4).

**MIDI Ctrl No. & Device:** For details refer to 12. (F2) Controller set (Modulation).

**Remarks:** Since the MODULATION 2 wheel is detented at the center position, it is especially useful for controlling pan. Since the MODULATION 2 wheel is assignable, to use it you must select the MIDI Ctrl No. to which it has been assigned. Check the *Utility mode System Utility 3. Controllers* (JUMP #803) settings to see the MIDI Control Number to which the assignable wheel has been set. For example if the assignable wheel has been set to its initial setting of MIDI Control Number 13, you would select "013:Non-assigned no." for the Pan Bias control number in order to use WHEEL 2 to control panning.

**Note:** When a voice is used in Multi Play mode, these Pan Control settings will be effective only if the Static Pan is set to Voice. Refer to Multi Edit 5. Voice static pan (JUMP #408, #409).

### COMMON DATA

## 12. (F4) Controller set (Other)

JUMP #228

**Summary:** Specify controller devices that will regulate the volume, the EG bias and the Cutoff Frequency of the filters in each element of the voice.

### Procedure:

- From: Voice Common job (JUMP #201)  
directory  
Select: job 12:Ctrlr  
Press: F4 (Othr) (JUMP #228)  
Specify: the controller and depth for each parameter

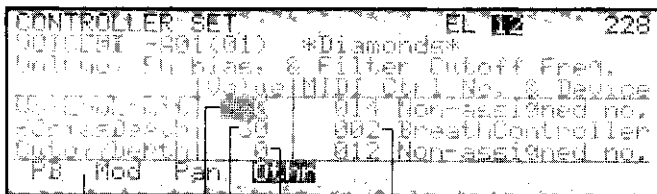

- 1 VolLowLimit (Volume Low Limit 0...127): This determines the lowest volume that can be set by the specified controller. For example when this is set to 80, the controller will reduce the volume no lower than 80. When this is set to 0, the controller can reduce the volume to silence. When this is set to 127, the controller will have no

effect on the volume. In addition to the controller specified here, the volume can always be controlled over its full range by an optional foot controller connected to the rear panel VOLUME jack.

- 2 EGbiasDepth (Eg Bias Depth 0...127): This determines the range over which the specified controller will control the EG bias. The result of controlling EG Bias for an AFM element will depend on the AModSens setting for each operator. If AModSens is set for carrier operators, the controller assigned to EG Bias will affect the volume of an AFM element. If AModSens is set for modulator operators, the controller assigned to EG Bias will affect the tone of an AFM element. For details refer to Voice AFM Element job 5. Sensitivity. For an AWM element, this setting will affect the Volume.
- 3 CutoffDepth (Filter Cutoff Depth 0...127): This determines the range over which the specified controller will increase the cutoff frequency specified for the filters of each element. Higher settings will allow the controller to brighten the tone. If the filter cutoff frequencies are already at maximum, this will have no effect. See the remarks below for details.



- ④ MIDI Ctrl No. & Device (0...120, Aftertouch): These settings determine which controllers will regulate each parameter.
- ⑤ To make controller settings for Pitch Bend, Modulation, or Pan, press F1, F2, or F3. Refer to sections 12. (F1), 12. (F2), or 12. (F3).

**MIDI Ctrl No. & Device:** For details refer to 12. (F2) *Controllers set (Modulation)*.

**Filter Cutoff Depth:** The controller assigned to CutoffDepth can be used in two ways to affect the filter, depending on the Control Source setting of each filter. Refer to *Voice AFM Element 8.3 Cutoff EG* or *Voice AWM Element 7.3 Cutoff EG*.

- Continuously control the filter cutoff: If the Control Source of a filter is set to LFO then the controller assigned to CutoffDepth can be used to continuously control the cutoff frequency even while a note is sounding.
- Control the filter cutoff at key-on: If the Control Source of a filter is set to EG or EG-VA then the controller assigned to CutoffDepth will be used only at the instant the note is played; i.e., after playing a note you can move the controller without affecting the sound. This can be used to give different filter cutoffs to individual notes as you play them.

COMMON DATA

## 13. Voice name

JUMP #229

**Summary:** Specify a ten-character name for the voice being edited. In voice play mode, this voice name will be displayed in large characters.

**Procedure:**

From: Voice Common job (JUMP #201)  
directory

Select: job 13:Name (JUMP #229)

Specify: the voice name

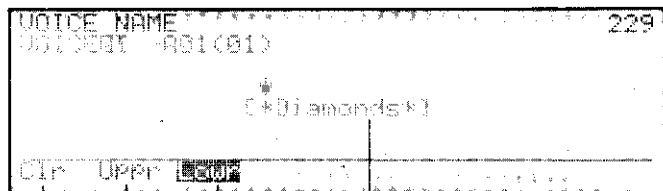

- ① Enter a ten-character name for the voice.
- ② To clear the currently entered name press F1 (Clr).
- ③ To switch to upper-case characters press F2 (Uppr).
- ④ To switch to lower-case characters press F3 (Lowr).

**Remarks:** Methods of entering character data are explained in *Introducing the SY77, How to use the numeric key pad*, on page 30.

COMMON DATA

## 15. Initialize voice

**Summary:** Initialize the Voice Common data being edited to a set of standard values. The Voice Mode will not change.

**Procedure:**

From: Voice Common job (JUMP #201)  
directory

Select: job 15:Init

To execute: initialization press YES

To quit: without initializing press NO

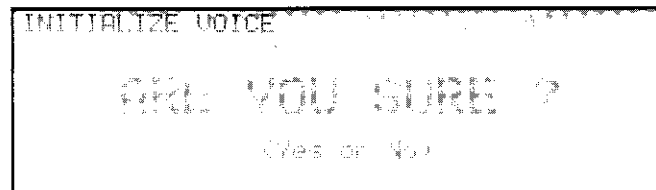

## VOICE EDIT MODE

This function sets all voice common data values to the minimum or simplest possible setting. When creating your own new voices, it is usually best to begin by editing an existing voice. However if you want to start from scratch, this Initialize function can often be helpful.

If you are sure you want to initialize the voice data, press YES and the voice common data of the voice being edited will be set to the values shown below. If you decide not to initialize, press NO.

This function initializes only Voice Common data. Other initialize functions are provided for initializing AFM Element or AWM Element data. Refer to *Voice AFM Element 15. Initialize* or *Voice AWM Element 15. Initialize*.

### Initialized settings for Voice Common Data

- 01 Element Levels
  - Voice Volume = 127
  - Element level = 127 (all elements)
- 02 Element Detune
  - Element detune =  $\pm 0$  (all elements)
- 03 Element Note Shift
  - Shift =  $\pm 0$  (all elements)
- 04 Element Note Limit
  - Low Limit = C-2 (all elements)
  - High Limit = G8 (all elements)
- 05 Element Velocity Limit
  - Low Limit = 1
  - High Limit = 127
- 06 Element Dynamic Pan
  - Element Preset 1-01 "Center" (all elements)
  - (Pan Source = velocity, Source Depth = 0,
  - Pan EG; HT=0, R1-RR2=63, L0-RL2=0,
  - SLP=S1)
- 07 Output Select
  - Output Group = Both (all elements)
- 08 Random Pitch
  - Random Pitch Depth = 0
- 09 Portamento
  - Mode = Follow (poly)/ Fingered (mono)
  - Speed = 0
- 10 Effect Set
  - Effect Mode = off
  - Stereo Mix = 1 and 2 both on
  - Effect Type = 00:through (all effects)
  - Effect Balance = 100% (all effects)
  - Output Level = 100% (all effects)
- 11 Micro Tuning Set
  - Preset-01 Equal Temperament
  - Element = off (all elements)
- 12 Controller Set
  - Pitch Bend Wheel Depth = 2
  - Aftertouch Pitch Bend Depth = 0
  - Pitch Modulation Depth = 64
  - Pitch Modulation Device = 1
  - Amplitude Modulation Depth = 64
  - Amplitude Modulation Device = 12
  - Filter Modulation Depth = 0
  - Filter Modulation Device = 1
  - Pan LFO Depth = 64
  - Pan LFO Device = 13
  - Pan Bias Depth = 0
  - Pan Bias Device = 10
  - Volume Low Limit = 0
  - Volume Low Device = 14
  - EG Bias Depth = 0
  - EG Bias Device = 2
  - Filter Cutoff Frequency Depth = 0
  - Filter Cutoff Frequency Devics = 12
- 13 Name Voice
  - Name = INIT VOICE

COMMON DATA

## 16. Recall voice

**Summary:** Recall the previously edited voice data.

**Procedure:**

From: Voice Common job (JUMP #201)  
directory

Select: job 16:Recall

To recall: the data press YES

To quit: without recalling press NO

```

RECALL VOICE
          ARE YOU SURE ?
          (Yes or No)
  
```

If after editing a voice you exit voice edit mode without storing, the edited voice data will be lost. In such cases, you can use this function to recall the previously edited voice data into the editing buffer.

If you are sure you want to recall, press YES and the previously edited voice data will be recalled into the editing buffer. If you decide not to recall, press NO.

This function recalls all voice data; element data as well as common data. The same function is also available when editing AFM Element or AWM Element data.

## AFM element data

AFM ELEMENT DATA

### AFM element job directory

JUMP #230

**Summary:** This job directory shows the editing jobs for an AFM element.

**Procedure:**

From: voice edit mode (JUMP #200 or #201)

When: editing a normal voice that contains AFM elements

Select: an AFM element F3-F6 (JUMP #230)  
(E1-E4).



- ① This area shows the number (1-4) and type (AFM or AWM) of elements in the selected voice mode.
- ② Move the cursor in this area to select a job and press ENTER to go to the selected job.

**01:Algrthm (Algorithm):**

F1; The algorithm determines how the six operators are connected. Three feedback sources can be selected and sent to other operators.

F2; Each operator can be modulated from an external source such as an AWM waveform or the noise generator.

F3; Each operator has two inputs In1 and In2 with input levels settings for each input.

**02:Osclltr (AFM oscillator):** The frequency produced by each operator can either be fixed or made to change according to the note played.

**03:EG (AFM operator EG):**

F1; Make operator EG settings for an individual operator while viewing a graphic display.

F2; Make operator EG settings for all operators.

**04:Output (AFM operator output):**

F1; The output level of each operator can be made to vary across the keyboard.

F2; The output level of each operator can be set.

**05:Sensitiv (AFM sensitivity):** The output level and frequency of each operator can be affected by key-on velocity or the LFO, and the EG rates of each operator can also be affected by key-on velocity.

**06:LFO (AFM LFO):**

F1; The Main LFO is used to create tremolo (amplitude modulation), vibrato (pitch modulation), or wah-wah (filter modulation).

F2; The Sub LFO is used to create vibrato (pitch modulation).

**07:PitchEG (AFM pitch EG):** The pitch EG creates a fixed shape of pitch change over time for each note, and can be switched on/off for each operator.

**08:Filter (AFM filter):** The two filters of each element can be used to control the tone in various ways. The filter EG creates a fixed pattern of tonal change over time, and a cyclically repeating signal from the LFO can be applied to the filter to create wah-wah.

**15:Initlz (Initialize AFM element):** The AFM element data being edited can be set to the minimum or simplest possible setting as a convenience when creating an element from scratch.

**16:Recall (Recall voice):** All data of the previously edited voice.

AFM ELEMENT DATA

## Operator on/off

**Summary:** Any time while editing an AFM element, you can turn the output of each operator off/on. This is useful when you want to hear how each operator affects the others, or when you want to hear only certain operators.

**Procedure:**

From: any job in the AFM job directory  
 Press: the OPERATOR ON/OFF buttons (memory select buttons 9–14) to turn operators 1–6 on/off.

The on/off condition of each operator is shown in the upper right of the LCD when editing an AFM element, and also indicated by the OPERATOR ON/OFF LEDs. Operators that are on are displayed in inverse. In the following LCD all operators are on.

**Remarks:** If you turn off all the carrier operators there will be no sound.

This function is provided as a help in editing. Operator on/off settings are not stored as part of voice data.

When you select a different AFM or AWM element or exit element editing, all operators you turned off will be turned back on.

AFM ELEMENT DATA

## AFM algorithm

JUMP #234

**Summary:** You can view a graphic display of the current algorithm at any time while editing an AFM element and select a different algorithm if you wish. Since the algorithm determines how each operator functions, you should always be aware of the algorithm when editing AFM operator data.

**Procedure:**

From: any job in the AFM (JUMP #231–#255)  
 job directory  
 Press: F8 (Alg) (JUMP #234)  
 To exit: to the previous editing job press EXIT

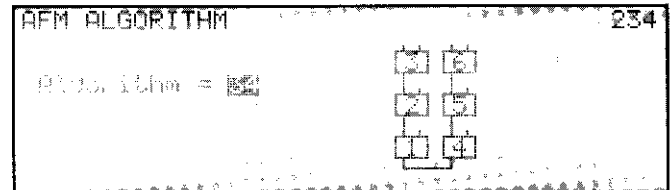

To return to the previous display, press EXIT.

**Note:** When you select an algorithm, all settings which modify the routings in the algorithm (feedback, input, etc.) will be cleared to their initial settings.

AFM ELEMENT DATA

## Copy element

**Summary:** While editing AFM element parameters other than EG, Output, Filter, or Effect, you can copy data from an element of another voice to the element you are now editing.

**Procedure:**

From: AFM element job 1, 2, 6, or 7  
 Press: COPY  
 Press: F1 (Src) and select the source voice  
 Press: F2 (Elem) and select the source element  
 To execute: the copy operation press F8 (Go)

## VOICE EDIT MODE

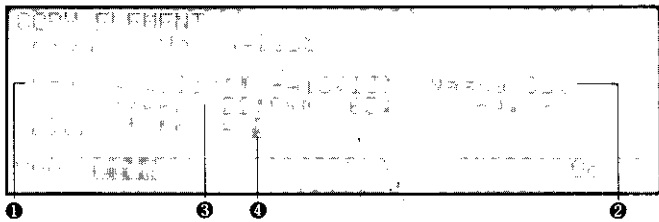

- ❶ Source Voice Select: Specify the memory (internal, card, preset 1 or preset 2), the bank A–D, and the number 1–16 of the voice from which you want to copy element data.
- ❷ Source Voice: The number and name of the selected source voice is displayed.
- ❸ Source Element Type: The type (AWM or AFM) of each element in the selected voice is displayed.

- ❹ Destination Element Number: Specify the element 1–4 of the selected Source Voice which you want to copy into the currently edited element. The type (AWM or AFM) of the selected element will be displayed in the Element Type line above. The selected source element must be the same type as the currently edited element. If not, the bottom line will show “Element type mismatch!”

After specifying the source voice and element, press F8 (Go). The display will ask “Are you sure?”. If you are sure you want to copy the element data then press YES, and the data will be copied.

AFM ELEMENT DATA

## Copy operator

**Summary:** While editing the parameters for operator EG or Output, you can copy EG and Output data from one operator to another.

**Procedure:**

From: AFM element job 3 or 4  
(JUMP #236–242)

Press: COPY

Select: the data type, source operator, and destination operator

To execute: the copy operation press F8 (Go)

- ❶ Data Type: Select one of the following types of data to be copied.  
EG&OUTPUT: Envelope generator, output level and scaling  
EG: Envelope generator  
OUTPUT: Output level and scaling
- ❷ Source: The specified data will be copied from this operator.
- ❸ Destination: The specified data will be copied to this operator.

**Remarks:** It is often the case that many or all operators in a voice have similar settings, especially for EG parameters. In such cases you can save time by setting the average EG for the voice on one operator, and then copying it to the others.

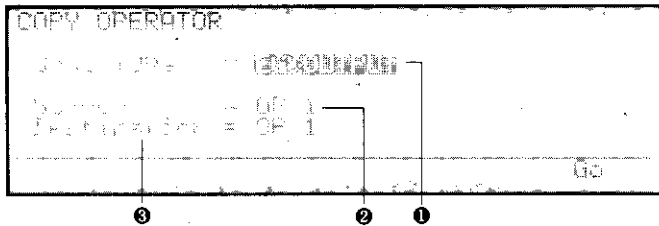

AFM ELEMENT DATA

## 1. (F1) AFM algorithm (Form)

JUMP #231

**Summary:** Select the Algorithm and specify feedback routings between operators.

**Procedure:**

From: AFM Element job directory (JUMP #230)

Select: job 01:Algrth., and press (JUMP #231)  
F1 (Form)

Specify: the algorithm number, and feedback sources and destinations

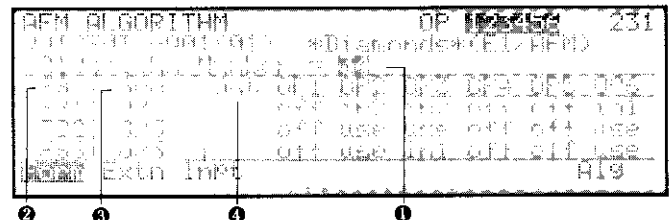

- ❶ Algorithm Number (1...45): Select the algorithm to determine the “arrangement” of the six operators in an AFM element. Refer to the following chart of the 45 algorithms. When you change the Algorithm, the Src ❸ and Dst ❹ settings explained below and the external input settings explained in the following section will be initialized.
- ❷ FB1–FB3: Feedback can be drawn from three of the operators in the algorithm and applied to any operator that has an unused input.
- ❸ Src 1–3 (OP1...OP6): Select the source of feedback for the three feedback routings. Any operator can be selected as the source of feedback. (In some algorithms, one or more feedback sources may be fixed by the choice of algorithm, and cannot be changed. In such cases, an “F” will be displayed after the Source (e.g., OP3F) and the Destination operator explained in ❹ will be displayed in uppercase characters (e.g., IN1)
- ❹ Dst OP1...OP6 (in1, in2): Select the destination of each feedback source. Each feedback source can be sent to as many destinations as you like. Each operator has two inputs, and an operator can be selected as a feedback destination only if at least one of its inputs is free. It makes no difference whether in1 or in2 is used, but remember that the input levels of each operator are set independently for in1 and in2. Refer to the following section 1.3 Algorithm Input.

If both inputs of an operator are already used by the algorithm connection, “-” will be displayed. If both inputs are already used because of a feedback assignment, “use” will be displayed. If the algorithm has a fixed feedback loop, the feedback destination operator will be displayed in uppercase characters (e.g., IN1). The cursor cannot be moved to the Dst setting for such operators.

Having three selectable feedback sources which can be sent to any or all other operators allows you to connect the operators in very complex ways. The following diagrams show how the operators would be connected for algorithm 40 when feedback sources and destinations are set as shown in the following table. Thin lines indicate the connections defined by the algorithm, and heavy lines indicate the feedback connections. Whether a connection between two operators is the result of the algorithm

or the result of feedback routing has no influence on the sound.

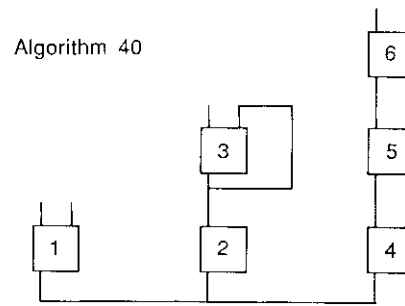

Feedback settings

FB	SRC	DST	OP1	OP2	OP3	OP4	OP5	OP6
FB1	OP3F		off	use	IN2	off	off	use
FB2	OP5		off	use	off	off	off	in1
FB3	OP4		off	in2	off	off	off	in2

Resulting connections

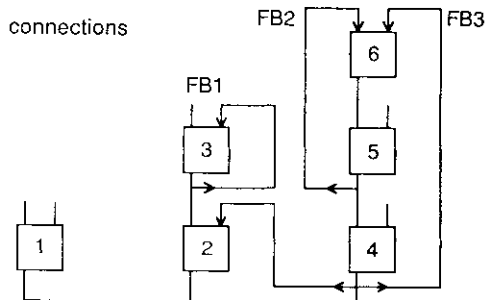

**Note:** If a carrier operator is used as a feedback source, the amount of feedback will vary depending on the number of carriers, since carrier output levels are automatically adjusted according to the number of carriers.

**Remarks:** In previous Yamaha 6-operator FM synthesizers, you had a choice of 32 algorithms each of which included one feedback loop. The SY77 provides broader possibilities with 45 algorithms, and three feedback loops that can be sent to more than one operator. In addition, operators can be modulated by external waveforms.

# 1. (F2) AFM algorithm (External input)

**Summary:** Modulate an operator from an external source such as AWM waveform or the noise generator.

**Procedure:**

- From: AFM Element job (JUMP #230) directory
- Select: job 01:Algrhm., and press (JUMP #232) F2 (Extn)
- Specify: noise and/or AWM input for each operator

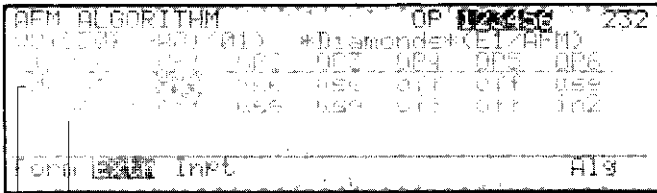

- ❶ Noise (off, in1, in2): The SY77 contains a noise generator which produces a type of white noise. This can be sent to any free operator input to modulate the operator.
- ❷ AWM (off, in1, in2): If the voice contains both AFM and AWM elements (ie., if the voice mode is either 9:1AFM&1AWM or 10:2AFM&2AWM), an AWM waveform can be received at any free operator input to modulate the operator.  
For voice mode 9:1AFM&1AWM, the waveform of AWM element 2 will be used to modulate AFM element 1. For voice mode

10:2AFM&2AWM, the waveform of AWM element 3 will be used to modulate AFM element 1, and the waveform of AWM element 4 will be used to modulate AFM element 2.

❶ and ❷: If both inputs of an operator are already used by the algorithm connection, “-” will be displayed. If both inputs are already used because of a feedback assignment, “use” will be displayed. The cursor cannot be moved to the Dst setting for such operators.

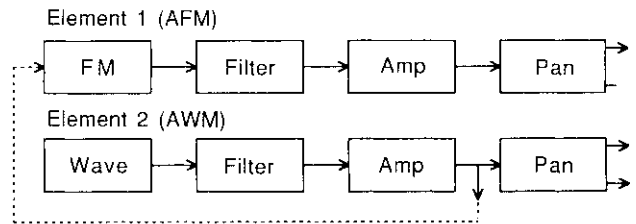

**Remarks:** Noise modulation makes it possible to create sounds that were difficult for previous FM synthesizers.

By using an AWM waveform to modulate one or more AFM operators, new harmonics can be added to the AWM sample. A simple example of this is given in *Using RCM Hybrid Synthesis* in the appendix.

# 1. (F3) AFM algorithm (Input level)

**Summary:** Set input levels In1 and In2 for each operator.

**Procedure:**

- From: AFM Element job (JUMP #230) directory
- Select: job 01:Algrhm. and press (JUMP #233) F3 (Inpt)
- Specify: the input level for each operator input

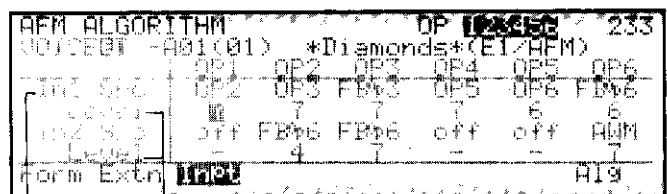

- ❶ In1 Src, In2 Src: This displays the input sources for input In1 and In2 of each operator, as determined by Algorithm and Feedback settings (F1) and External input settings (F2). The input sources cannot be changed from this job.



- ② In1 Level, In2 Level (0...7): Adjust the input level of In1 and In2 for each operator. If an operator input is not used, the Src will display "off" and the "Level will display "-". The cursor cannot be moved to the Level setting for such operators.

**Remarks:** Previous FM synthesizers allowed you to set only the output level of each operator.

However on the SY77, the input levels in1 and in 2 of each operator can also be set. If the input source is the feedback from another operator, the input level setting functions as the feedback level.

Correct adjustment of input levels is especially important when bringing in AWM to AFM as a modulator.

AFM ELEMENT DATA JUMP #235

## 2. AFM oscillator

**Summary:** Set frequency-related parameters for each operator.

**Procedure:**

- From: AFM Element job (JUMP #230) directory
- Select: job 02:Osclltr (JUMP #235)

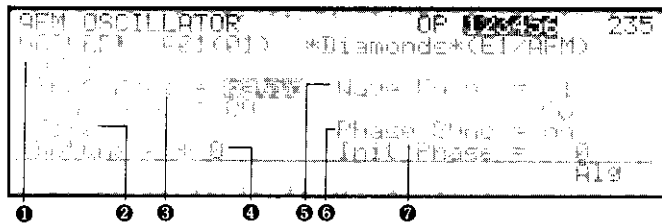

- ① Operator (1-6): This displays the operator being edited. To move to another operator, use the OPERATOR SELECT buttons OP1...OP6.
- ② Freq Mode (fixed, ratio): When "fixed" is selected the operator will produce the same pitch regardless of what note is played. When "ratio" is selected the operator pitch will depend on the note that is played
- ③ Coarse/Fine (0 Hz...9762 Hz in Fixed Frequency mode, 0.5...61.69 in Ratio Frequency mode): This setting specifies the pitch produced by the operator. By moving the cursor to coarse or fine you can adjust the pitch in large steps or in small steps. When the Freq Mode is set to "fixed" the range is 0 Hz...9762 Hz. When the Freq Mode is set to "ratio" the range is 0.5...61.69. (In "ratio" mode with a Coarse/Fine setting of 1.0 the A3 key will produce the standard pitch of 440 Hz.)
- ④ Detune (-15...+15): The pitch of each operator can be adjusted in fine steps of 1.171875 cents.

- ⑤ Waveform (1...16): Each operator can produce sixteen different waveforms; a sine wave with no harmonics, and fifteen other more complex waveforms containing additional harmonics. This allows you to create complex waveforms using fewer operators. A graphic display of the selected waveform is shown below the waveform number. The table below shows the harmonic content of each waveform.
- ⑥ Phase Sync (on, off): When phase sync is on, the selected waveform will be re-started each time a key is pressed.
- ⑦ Init Phase (0...127): This determines the initial phase position from which the selected waveform will be re-started when phase sync is on. The init phase range of 0...127 corresponds to a range of 0...360 degree starting phase. This setting is effective only when Phase Sync is on.

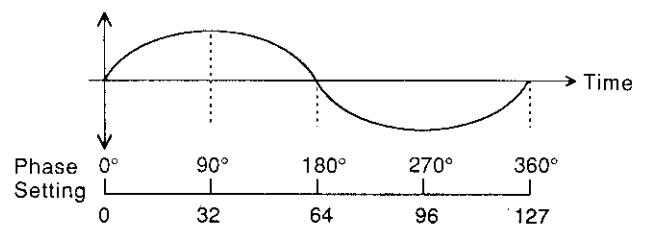

**Waveform:** The sixteen waveforms that can be produced by each operator are not modeled after any "real" instrument but are mathematical transformations of sinewaves. The following chart shows the harmonic content of each waveform. The amplitude of each harmonic partial is given as a percentage of the fundamental.

# VOICE EDIT MODE

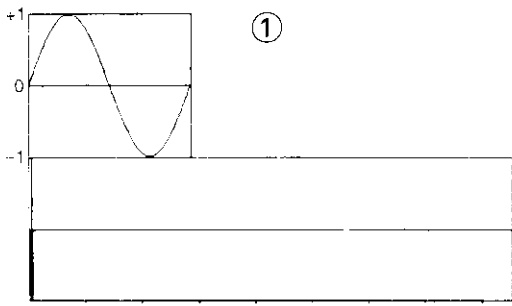

①

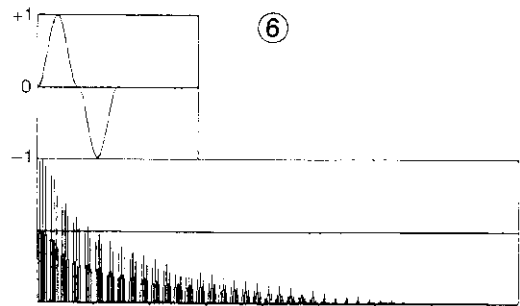

⑥

The  $-100\text{dB}$  level is exceeded by harmonics up to the 130th harmonic. [4th terms do not exist]

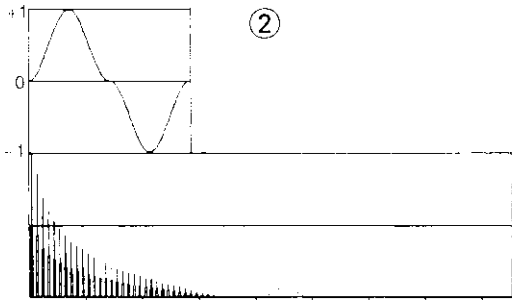

②

The  $-100\text{dB}$  level is exceeded by odd harmonics up to the 65th harmonic.

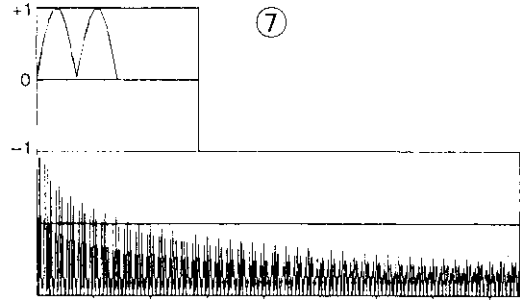

⑦

The  $-100\text{dB}$  level is exceeded by all harmonics except  $(4n-2)$  terms which do not exist.

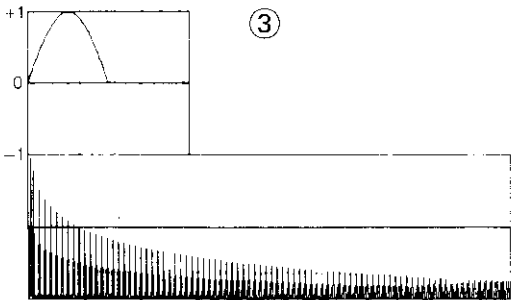

③

The  $-100\text{dB}$  level is exceeded by even harmonics up to the 392nd harmonic.

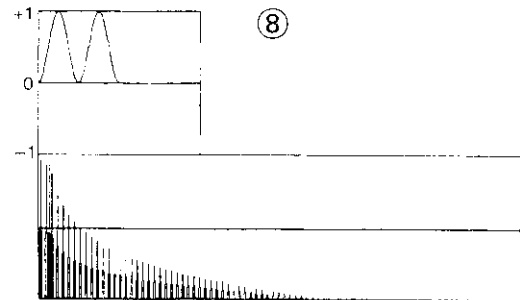

⑧

The  $-100\text{dB}$  level is exceeded by the 4th harmonic, and odd harmonics up to the 99th harmonic.

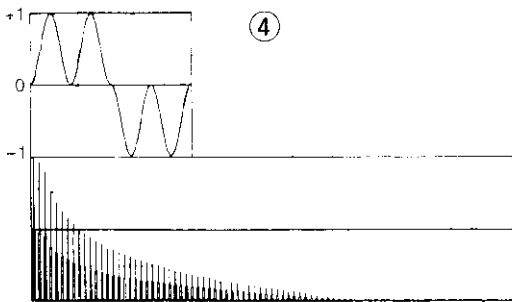

④

The  $-100\text{dB}$  level is exceeded by odd harmonics up to the 113th harmonic.

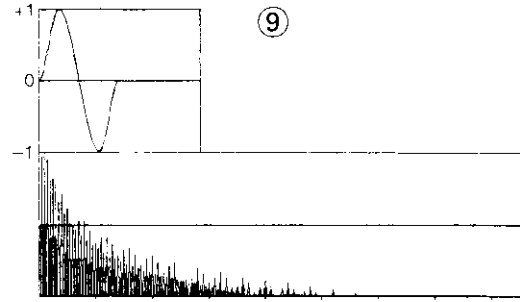

⑨

The  $-100\text{dB}$  level is exceeded by even harmonics up to the 112th harmonic, and odd harmonics up to the 73rd harmonic.

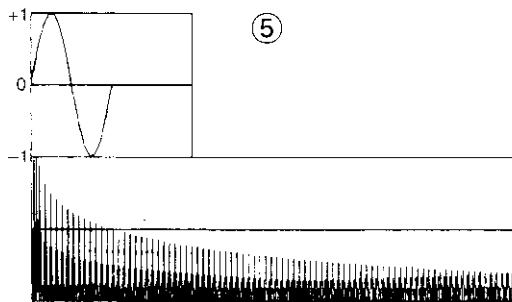

⑤

The  $-100\text{dB}$  level is exceeded by the 2nd harmonic, and all odd harmonics.

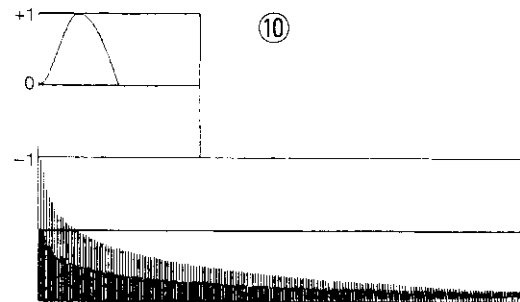

⑩

The  $-100\text{dB}$  level is exceeded by all harmonics up to the 270th harmonic.

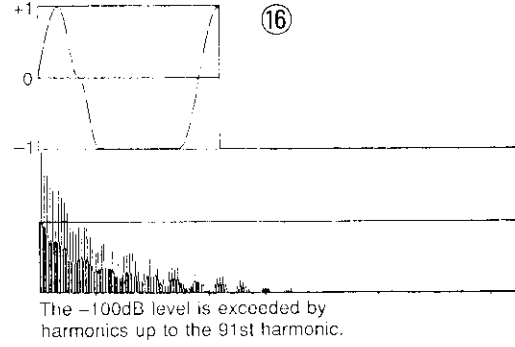
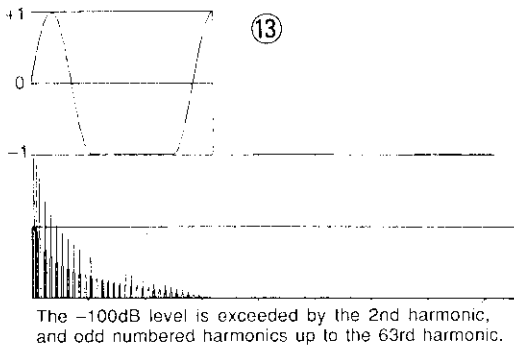
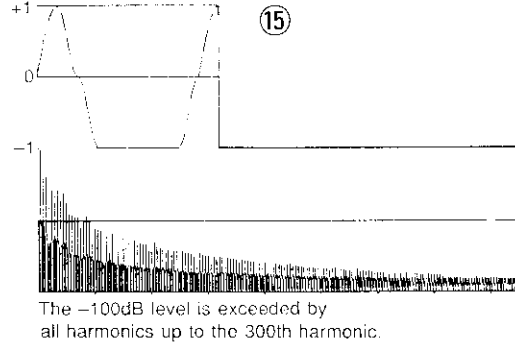
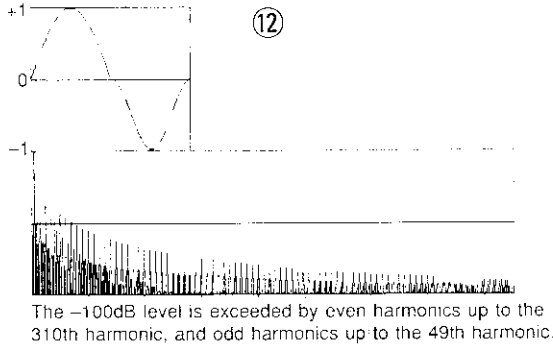
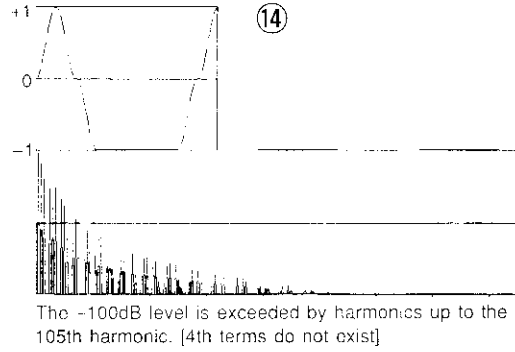
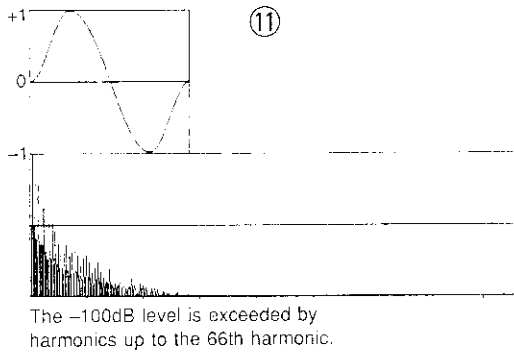

AFM ELEMENT DATA **3. (F1) AFM operator EG (Each operator)** JUMP #236

**Summary:** Make EG settings for a single operator while viewing a graphic display of the operator envelope.

**Procedure:**

From: AFM Element job (JUMP #230) directory

Select: job 03:EG and press F1 (Each)  
 EG rates press F3 (Rate) (JUMP#236)  
 EG levels press F4 (Lvl) (JUMP#237)

Specify: envelope parameters for the selected operator

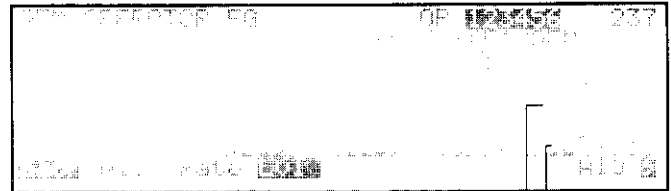

- ❶ The number of the currently selected operator is displayed. To move to another operator, use the OPERATOR SELECT buttons OP1...OP6.
- ❷ This indicates the time range of the EG graphic display. A range of "x1" shows the shortest time and gives the greatest detail. To change the range, hold SHIFT and press F1-F6 (x1, x2, x5, x10, x20, x50).
- ❸ This indicates the segment from which the EG graphic display begins. To shift the display to a different segment, hold SHIFT and press F7 or F8 to select Seg0-Seg4 or Rel1.

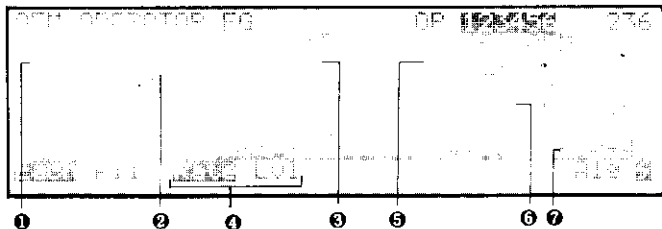

## VOICE EDIT MODE

- 4 Press F3 (Rate) to set EG rates. Press F4 (Lvl) to set EG levels.
- 5 To change the range of the EG graphic display, hold SHIFT and press F1–F6 (x1, x2, x5, x10, x20, x50).
- 6 To shift the EG graphic display to a different segment, hold SHIFT and press F7 or F8.
- 5 HT (Keyon Delay Time 63...0): When this is set to 0, the operator EG will begin immediately after a key is pressed. For higher settings, there will be an increasingly longer delay before the operator EG begins.
- 6 R1–R4, RR1–RR2 (Keyon Rates, Release Rates 0...63): Keyon Rates 1–4 and Release Rates 1–2 determine the speed of the operator EG. Higher settings result in faster change.
- 7 RS (Rate Scaling –7...+7): Rate Scaling allows the operator EG rates to be increased or decreased depending on the key that is played. For positive settings the EG rates will increase as you play higher notes, resulting in shorter envelopes. For negative settings the EG rates will decrease as you play higher notes, resulting in longer envelopes.
- 8 L0–L4, RL1–2 (Keyon Levels, Release Levels 0...63): Keyon Levels 0–4 and Release Levels 1–2 determine the levels of the operator EG.
- 9 SLP (Segment Loop Point S1...S4): This specifies the segment from which the EG will continue looping if a key remains depressed after the EG has arrived at level L4.

**Rates and Levels:** When you press a key, the operator output will be at the level of L0. When the specified hold time (HT) has elapsed, the level will change at the rate of R1 to level L1. When the level reaches L1, it will change at the rate of R2 to the level of L2. When the level reaches L2, it will change at the rate of R3 to the level of L3. When the level reaches L3, it will change at the rate of R4 to the level of L4. When the level reaches L4, the EG will begin looping from the specified segment.

When you release the key, the level will change at the rate of RR1 to the level of RL1. When the level reaches RL1, it will change at the rate of RR2 to the level of RL2.

Remember that Hold Time (HT) is a *time* setting, but the various Rates are *speed* settings. Higher settings for Hold Time will result in a longer delay before the operator EG begins,

but higher settings for Rates will result in faster change.

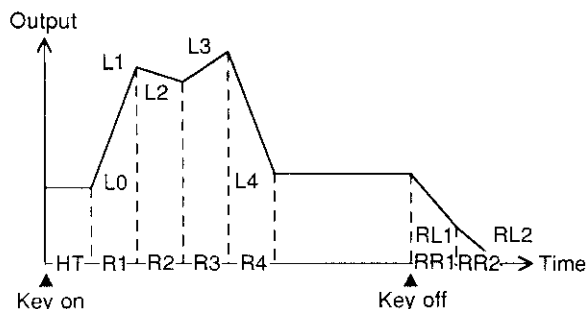

**Segment Loop Point:** The SLP setting determines the Level from which the EG will loop. If you continue holding a note after Level 4 is reached, when SLP is set to ...

- SLP=S1 the level will change L4 → L1 → L2 → L3 → L4 → L1 → ...
- SLP=S2 the level will change L4 → L2 → L3 → L4 → L2 → ...
- SLP=S3 the level will change L4 → L3 → L4 → L3 → ...
- SLP=S4 the level will remain at L4

The following diagram shows how EG levels would change when SLP=S3

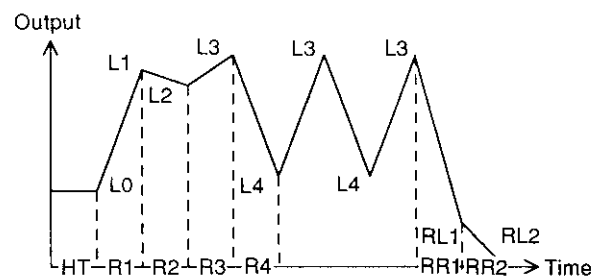

**Rate Scaling:** On most acoustic instruments, high notes have a naturally shorter attack and decay. This can be simulated by setting rate scaling to a positive value (+1...+7). The following diagram shows how higher notes will have faster rates (shorter EGs). Negative settings will have the opposite effect.

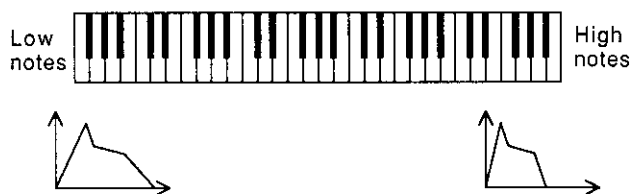

### 3. (F2) AFM operator EG (All operators)

**Summary:** Make operator EG settings for all operators while viewing the data for all operator EGs in a single screen.

**Procedure:**

- From: AFM Element job directory (JUMP #230)
- Select: job 03:EG and press F2 (All)
- Specify: EG key-on rates (R1-R4) (JUMP #238)
- EG key-on levels (L1-L4) (JUMP #239)
- EG key-off rates and levels (RR1-2, RL1-2)

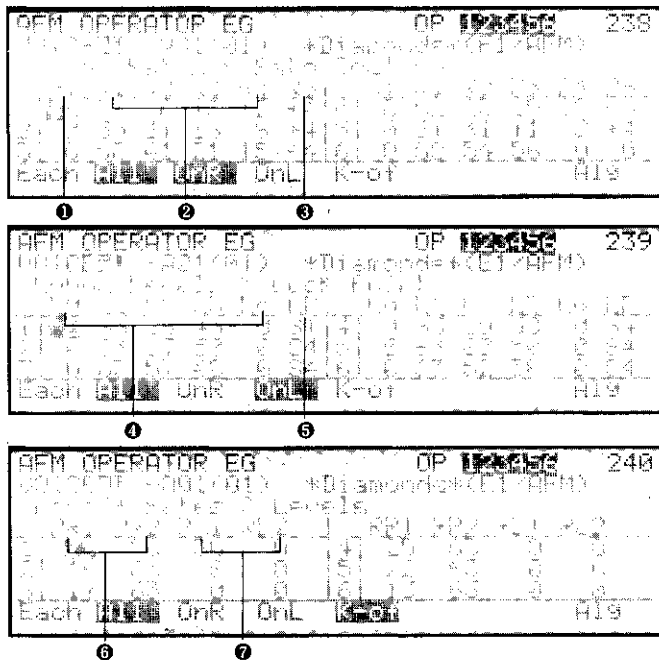

- 1 HT (Keyon Delay Time 63...0): This specifies the time by which the beginning of the EG will be delayed after a key is pressed.
- 2 R1-R4 (Keyon Rates 0...63): Keyon Rates 1-4 determine the speed of the operator EG while a key is being pressed.
- 3 RS (Rate Scaling -7...+7): Rate Scaling determines how the key position will affect the operator EG rates.
- 4 L0-L4 (Keyon Levels 0...63): These determine the levels to which the operator EG will move while a key is being pressed.
- 5 LP (Segment Loop Point S1...S4): This specifies the segment from which the EG will continue looping if a key remains depressed after the EG has arrived at level L4.
- 6 R1, R2 (KeyOff Rates 0...63): These determine the speed with which the operator EG will change levels after a key is released.
- 7 L1, L2 (KeyOff Levels 0...63): These determine the levels to which the operator EG will change after a key is released.

The meaning of these EG parameters is explained in the previous section 3.1 Operator EG.

In this AFM operator EG (All) display, the OPERATOR SELECT buttons cannot be used to select operators.

### 4. (F1) Operator output (Each)

**Summary:** Set output level and scaling for a single operator while viewing a graphic display of the scaling.

**Procedure:**

- From: AFM Element job directory (JUMP #230)
- Select: job 04:Output and press (JUMP #241)
- F1 (Each)
- Specify: the output level and scaling for the selected operator

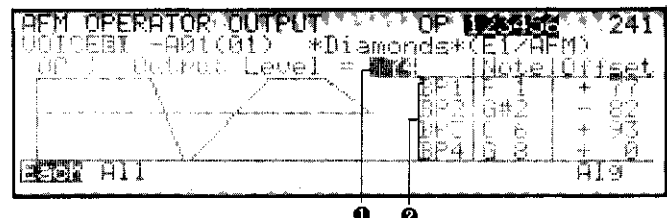

- 1 Output Level (0...127): The output level of the operator
- 2 BP1-4 (Break Point 1-4): Note (C-2...G-8) and Offset (-127...#127) of each Break Point determine how the output level of each operator will

## VOICE EDIT MODE

vary across the keyboard. When the cursor is located at note, you can press F7 (Kbd) and press a key to enter the new note setting.

**Output Level:** This sets the output level of each operator. The output level of a carrier operator will affect the volume, and the output level of a modulator operator will affect the tone. Remember that the input levels of each operator input In1 and In2 can also be adjusted as explained in *1. (F3) Algorithm (Input level) (JUMP #233)*. Even if the output level of an operator is raised, it will have no effect on another operator to which it is connected if the corresponding input level of the operator is set at 0.

**Break Point:** The operator output level can be made to vary depending on the note that is played. On most acoustic instruments, notes differ in volume and tone depending on the range in which they are played. For example the low notes of a piano are more tonally complex and louder than the high notes.

Use the four break points to specify how the operator output level will be adjusted across the keyboard.

- Offset (-127...+127) determines the output level adjustment for each of the four points specified by Note.
- The four note settings must be in ascending order. It is not possible to set a break point to a note lower or higher than the note settings of the neighboring break points.

The following diagram shows how the operator output level would be adjusted across the keyboard for the settings shown in the above LCD.

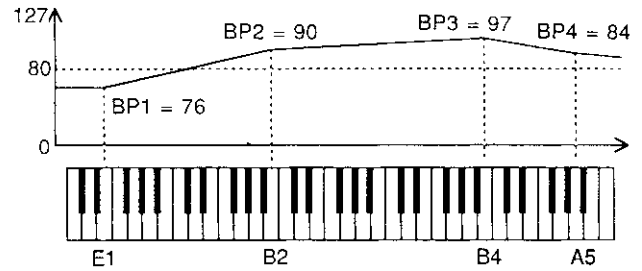

Each offset is added to the overall operator output level of 80. For example the offset at break point 1 (E1) is -4, so the resulting operator output level at E1 is 76. The resulting operator output level is limited to the range of 0...127.

AFM ELEMENT DATA

## 4. (F2) AFM operator output (All)

JUMP #242

**Summary:** Set operator output level while viewing output levels for all operators. (Output scaling cannot be set in this job.)

**Procedure:**

From: AFM Element job directory (JUMP #230)

Select: job 04:Output and press (JUMP #242)

F2 (All)

Specify: the output level of each operator

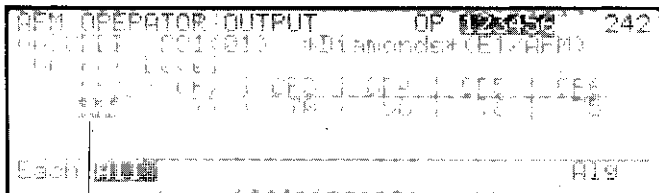

- ❶ Output Level OP1-OP6 (0...127): Set the output level of each operator. This is the same setting as explained in ❶ of the previous section *4. (F1) AFM operator output*. The difference is that here you can view and set the output level for all six operators at once. However break point Levels and Offsets cannot be set here.

**Remarks:** Refer to *4. (F1) AFM operator output* for details.

**Note:** In algorithms with two or more carriers, some Velocity Sensitivity settings may cause distortion. In this case, reduce carrier levels.

## 5. AFM sensitivity

**Summary:** These settings determine how each operator will be affected by key-on velocity and by the LFO.

**Procedure:**

- From: AFM Element job directory (JUMP #230)
- Select: job 05:Sensitiv (JUMP #243)
- Specify: the sensitivity of each operator

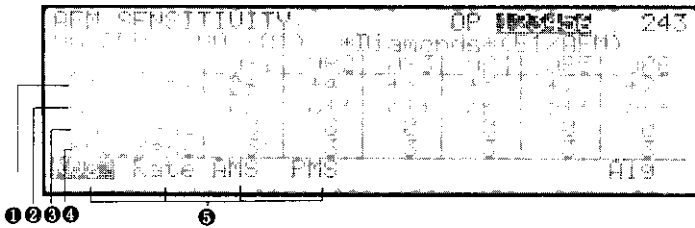

- 1 Velocity (-7...+7): This determines how the output level of each operator will be affected by key-on velocity. For positive settings (+1...+7) the output level will increase as you play more strongly. For negative settings (-1...-7) the output level will decrease as you play more strongly.
- 2 Rate Velocity (on/off): When the Rate Velocity switch is "on", key-on velocity will affect the operator EG R1. The result will depend on the Velocity setting.  
 Velocity = +1...+7: If Rate Velocity is on, strongly played notes will cause the operator EG R1 to increase, resulting in a faster attack. For notes played with maximum velocity, R1 will be at the value specified by the EG settings.  
 Velocity = -1...-7: If Rate Velocity is on, strongly played notes will cause the operator EG R1 to decrease, resulting in a slower attack. To hear the effect of negative settings you will need to lower the operator output level.  
 When the Rate Velocity switch is "off", the operator EG R1 will not be affected by key-on velocity.

- 3 AModSens (0...7): Amplitude Modulation Sensitivity determines how greatly the output level of each operator will be affected by Amplitude Modulation from the LFO.
- 4 PModSens (0...7): Pitch Modulation Sensitivity determines how greatly the pitch of each operator will be affected by Pitch Modulation from the LFO.
- 5 Pressing F1 (KVS), F2 (Rate), F3 (AMS), or F4 (PMS) will move the cursor to Velocity, Rate Vel, AModSens, or PModSens.

**AModSens and PModSens:** These settings determine the *sensitivity* of each operator to the Amplitude Modulation Depth (AMD) and/or Pitch Modulation Depth (PMD) produced by the LFO. Refer to 6.(F1) AFM LFO (Main) (JUMP #244). If the LFO settings for AMD and/or PMD are set to 0, these AModSens and PModSens settings will have no effect.

PModSens determines the sensitivity of each operator to PMD from the Main LFO. Independently of this, the pitch of an AFM element can also be affected by the Sub LFO. Refer to 6.(F2) AFM LFO (Sub) (JUMP #245).

In this *AFM sensitivity* display, the OPERATOR SELECT buttons cannot be used to select operators.

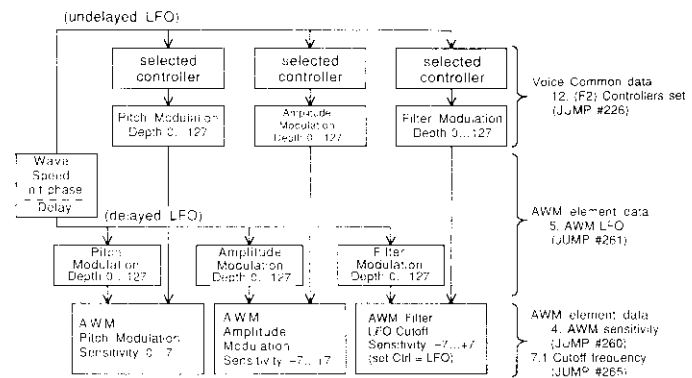

## 6. (F1) AFM LFO (Main)

**Summary:** The Main LFO creates a cyclically changing control signal that can be used to create tremolo (amplitude modulation), vibrato (pitch modulation), and wah-wah (filter modulation).

**Procedure:**

- From: AFM Element job directory (JUMP #230)
- Select: job 06:LFO and press (JUMP #244)
- F1 (Main)
- Specify: parameters for the main LFO

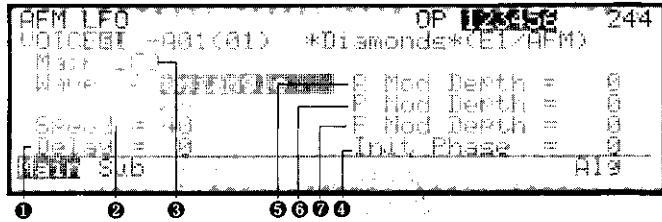

① Wave (triangle, saw down, saw up, square, sine, sample&hold): This selects the wave (shape of modulation) produced by the Main LFO. The selected wave is graphically displayed in the LCD. When sample&hold is selected, the LFO will produce a control signal whose level will change randomly at intervals of time determined by the Speed setting.

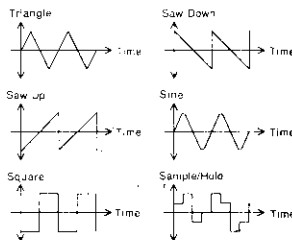

- ② Speed (0...99): The speed of the LFO modulation. Higher settings result in faster modulation.
- ③ Delay (0...99): The time delay before the LFO modulation begins.
- ④ Init Phase (0...99): Initial Phase determines the point of the waveform from which the LFO will begin when a key is pressed. The LFO waveform always starts over again from this initial phase point when each note is played. An initial phase setting of 0...99 corresponds to a phase of 0...360 degrees.

- ⑤ A Mod Depth (0...127): Amplitude Modulation Depth determines how much the LFO will affect the output level (amplitude) of the operators. For this setting to have an effect, the AModSens (amplitude modulation sensitivity) of an operator must be set above 0. Refer to 5. *AFM sensitivity*.
- ⑥ P Mod Depth (0...127): Pitch Modulation Depth determines how much the LFO will affect the pitch of the operators. For this setting to have an effect, the PModSens (pitch modulation sensitivity) of an operator must be set above 0. Refer to 5. *AFM sensitivity*.
- ⑦ F Mod Depth (0...127): Filter Modulation Depth determines how much the LFO will affect the cutoff frequency of the filter. For this setting to have an effect, the Ctrl setting of a filter must be set to "LFO", and the LFO Cutoff Sens setting must not be 0. Refer to 8. *(F1) AFM filter (Cutoff frequency)*.

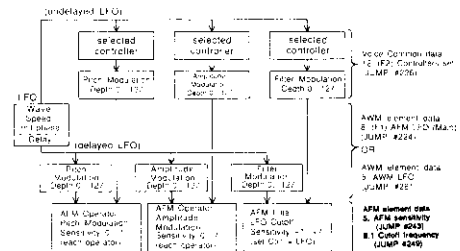

AFM ELEMENT DATA

## 6. (F2) AFM LFO (Sub)

JUMP #245

**Summary:** The Sub LFO is completely independent of the Main LFO, but can be used only to create vibrato (pitch modulation). This will apply equally to all operators, and is not affected by pitch modulation sensitivity.

**Procedure:**

- From: AFM Element job directory (JUMP #230)
- Select: job 06:LFO and press (JUMP #245)
- F2 (Sub)
- Specify: parameters for the sub LFO

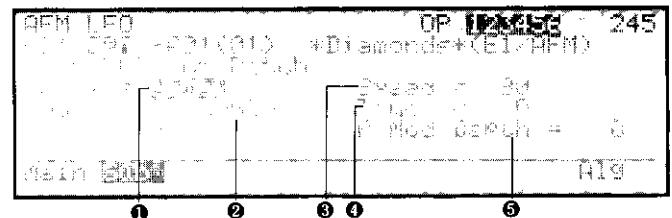

- ① Mode (delay, decay): When this is set to "delay", the Sub LFO will begin after the time delay specified by ④ Time. When this is set to "decay", the Sub LFO will begin fading out after the time specified by ④ Time.
- ② Wave (triangle, saw down, square, sample&hold): The wave produced by the Sub LFO.



- ③ Speed (0...99): The speed of the LFO modulation. Higher settings result in faster modulation. The speed of the sample&hold wave will be faster than the other waves.
- ④ Time (0...99): The time length used for Sub LFO delay or decay.
- ⑤ P Mod Depth (0...127): The depth of pitch modulation produced by the Sub LFO.

**Wave:** The following four waveforms can be selected for the Sub LFO.

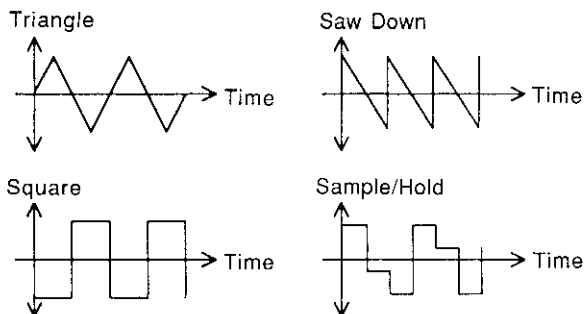

**Mode and Time:** The mode and time settings work together to determine how the Sub LFO will begin or end. When Mode=delay the Sub LFO will begin after the time delay specified by ④ Time. When Mode=decay the Sub LFO will affect the sound beginning immediately from when the key is pressed, but will gradually die out after the time delay specified by ④ Time.

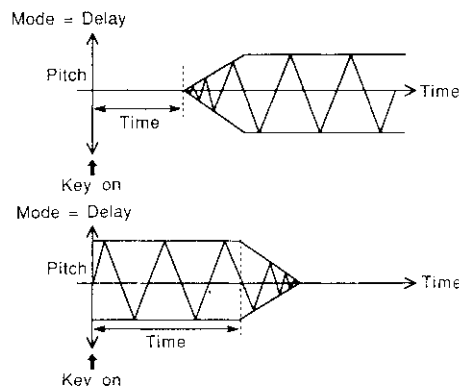

AFM ELEMENT DATA

## 7. (F1) AFM pitch EG (Switch)

JUMP #246

**Summary:** The pitch change over time created by the pitch EG can be switched on/off for each operator. To set the shape of the pitch EG, see 7. (F2) AFM pitch EG (EG settings).

**Procedure:**

- From: AFM Element job directory (JUMP #230)
- Select: job 07:PitchEG and press (JUMP #246)
- F1 (Sw)
- Specify: pitch EG switches, scaling, and range



- ① PEG Sw (off, on): When the Pitch EG Switch is "off" for an operator, it will not be affected by the pitch EG.
- ② Rate Scaling (-7...+7): Pitch EG Rate Scaling determines how pitch EG rates will change according to the note played. When this is set to +1...+7, the pitch EG will be faster for higher notes. When this is set to -1...-7, the pitch EG will be slower for higher notes. When this is set to 0, the pitch EG will be the same rate for all notes.

- ③ Velocity Sw (off, on): When this is on, strongly played notes will cause the pitch EG to change over a greater range.
- ④ Range (1/2 oct, 1 oct, 2 oct, 8 oct): This determines the maximum range of the AFM pitch EG, from 1/2 octave to 8 octaves.

**PEG Sw:** When using the Pitch EG to make the pitch of a sound change over time, you will normally turn the PEG switch on for *all* operators. If the pitch of a modulator operator changes while the pitch of another operator it is modulating remains constant (or vice versa), the *carrier:modulator* ratio will shift during the duration of the sound, changing the overtone structure. This can be an interesting effect in its own right.

**Rate Scaling:** This setting determines how Pitch EG Rates (the speed of pitch change) will be affected by the key number of each note. The following diagram shows the result when Pitch EG Rate Scaling is set to +7. Notice that high notes have a shorter pitch EG (faster EG rates) than lower notes.



**Velocity Sw (velocity switch):** When this is “on”, strongly played notes will cause the pitch EG to change over a greater range.

AFM ELEMENT DATA

## 7. (F2) AFM pitch EG (EG settings)

JUMP #247

**Summary:** The pitch EG creates a fixed shape of pitch change over time for each note. To switch the pitch EG on/off for each operator, see 7. (F1) *AFM pitch EG (Switch)*.

**Procedure:**

- From: AFM Element job directory (JUMP #230)
- Select: job 07:PitchEG and press (JUMP #247)
- F2 (EG)
- Specify: pitch EG parameters

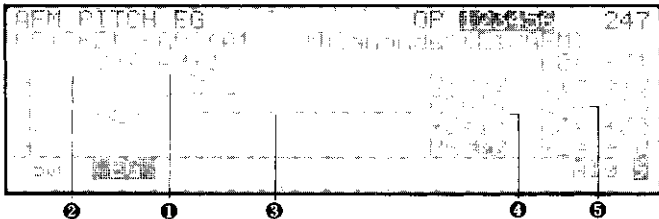

- 1 This indicates the EG segment (“seg1–3” or “rel1”) from which the pitch EG graphic display begins. If the EG is too long to be fully shown in the LCD, hold SHIFT and press F7 or F8 to move the pitch EG graphic display to a different segment.
- 2 This indicates the time length shown by the graphic display. To change this, hold SHIFT and press F1–F6 (x1, x2, x5, x10, x20, x50). The exact length of time will depend on the range. When the pitch EG range is 1 octave, the graphic display will cover approximately 0.5 seconds at “x1” and approximately 5 seconds at “x50”.
- 3 The pitch EG is graphically displayed.
- 4 R1–R3, RR1 (0...63): Keyon Rates 1–3 and the Release Rate determine the speed of the pitch EG. Higher settings result in faster change. A rate of 63 will make the pitch jump instantly to the next level.

- 5 L0–L3, RL (-64...+63): Keyon Levels 0–3 and the Release Level determine the levels of the pitch EG. Positive settings raise the pitch and negative settings lower the pitch.

**Rates and Levels:** When you press a key, the pitch will begin at the level of L0, and will change at the rate of R1 to level L1. When the level reaches L1, the pitch will change at the rate of R2 to the level of L2. When the pitch reaches L2, it will change at the rate of R3 to the level of L3 and will stay at L3 as long as the key is pressed.

When the key is released, the pitch will change at the rate of RR to the level of RL.

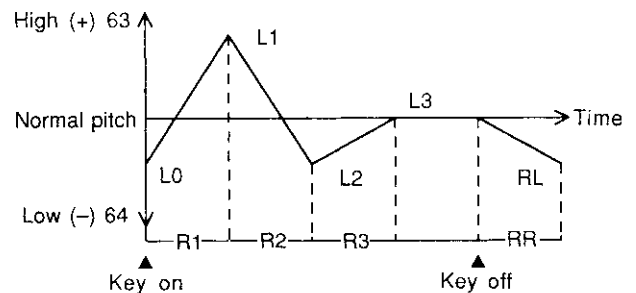

**Note:** Even if the AFM pitch EG and the AWM pitch EG have identical Rate settings, there will be slight differences in the timing of the pitch change.

AFM ELEMENT DATA

## 8. AFM filter

JUMP #248

**Summary:** The two filters of each element can be used to control the tone in various ways.

**Procedure:**

- From: AFM Element job directory (JUMP #230)
- Select: job 08:Filter (JUMP #248)
- Specify: the desired job and press ENTER

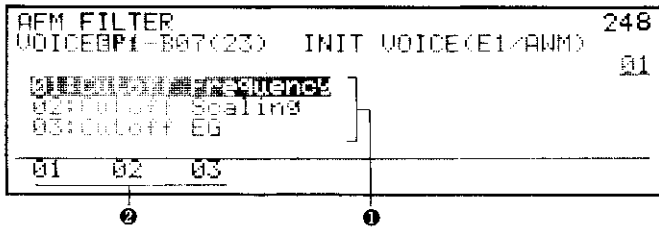

- 1 Move the cursor in this area to select a job and press ENTER to move to the selected job.
  - 01: Cutoff Frequency: Make overall settings for the filters.
  - 02: Cutoff Scaling: Specify how each filter will be adjusted across the keyboard.
  - 03: Cutoff EG: Specify how each filter will change over time.
- 2 Pressing F1-F3 will select the corresponding job.

AFM ELEMENT DATA / AFM FILTER

## 8.0 Copy filter

**Summary:** Any time while editing a filter, you can copy the data from one filter to the other filter.

**Procedure:**

- From: 8.1 Cutoff Frequency (JUMP #249)
- 8.2 Cutoff Scaling (JUMP #250)
- 8.3 Cutoff EG (JUMP #252-#255)

Press: COPY

Select: the copy direction (1 → 2 or 2 → 1)

To execute: the copy operation press F8 (Go)

To quit: without copying press EXIT

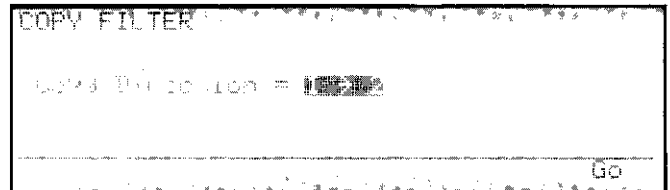

Specify whether to copy the data from filter 1 to filter 2 (1 → 2) or from filter 2 to filter 1 (2 → 1). Press F8 (Go) and the data will be copied. If you decide not to copy the data, press EXIT to exit without copying.

The filter type (HPF/LPF/THRU) will not be copied.

AFM ELEMENT DATA / AFM FILTER

## 8.1 Cutoff frequency

JUMP #249

**Summary:** Each filter can be set to a different type, cutoff frequency, and control source. Overall resonance, velocity sensitivity, and LFO Cutoff Sensitivity can also be specified.

**Procedure:**

- From: AFM Element job directory 8. AFM filter (JUMP #248)
- Select: 01:Cutoff Frequency (JUMP #249)
- Specify: parameters for filters 1 and 2

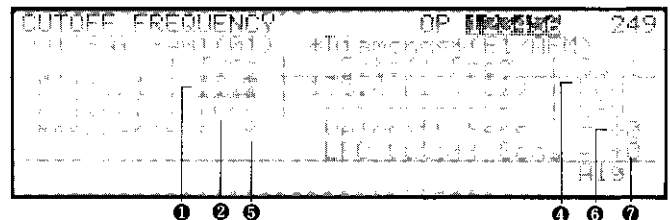

- 1 Filter 1 Type (Thru, LPF, HPF): Filter 1 can be used either as a Low Pass Filter (LPF) or as a High Pass Filter (HPF). When "Thru" is selected the filter will have no effect.

## VOICE EDIT MODE

- ② **Filter 2 Type (Thru, LPF):** Filter 2 can be used only as a LPF.
- ③ **Cutoff Freq (HPF = 0 Hz ... 11.66 kHz (0...114); LPF = 0 Hz ... 22.43 kHz (0...127)):** The cutoff frequency of each filter can be adjusted independently. The number 0...127 displayed in parentheses indicates the data value input when using the numeric keypad. Note that the highest HPF setting is 11.66 kHz.
- ④ **Ctrl (EG, LFO, EG-VA):** Each of the two filters can be controlled in a different way. For details, see the explanations below for *Ctrl = EG*, *Ctrl = LFO*, *Ctrl = EG-VA*.
- ⑤ **Resonance (0...99):** Higher settings of resonance will result in a more pronounced peak of emphasis at the cutoff frequency. This setting will apply to both filters 1 and 2.
- ⑥ **Velocity Sens (-7...+7):** This determines how the cutoff frequency of both filters will be affected by key-on velocity. For positive settings (+1...+7) the cutoff frequency will increase as you play more strongly, resulting in a brighter sound. For negative settings (-1...-7) the cutoff frequency will decrease as you play more strongly, resulting in a darker sound.
- ⑦ **LFO Cutoff Sens (-7...+7):** This determines how Filter Modulation from the Main LFO will affect the filters. This setting also determines how sensitive the filters will be to the controller assigned to Filter Bias in *Voice common data 12. (F4) Controller (JUMP #228)*. Negative settings will reverse the effect of the assigned controller.

**Type and Cutoff Freq:** Filter 1 can be used either as a Low Pass Filter (LPF) or as a High Pass Filter (HPF), and filter 2 can be used only as a LPF.

When set to LPF, filters 1 and 2 will allow sound lower than the cutoff frequency to pass unchanged, and will diminish the sound above the cutoff frequency. When set to HPF, filter 1 will allow sound higher than the cutoff frequency to pass, and will diminish the sound below the cutoff frequency.

Low Pass Filter (LPF)

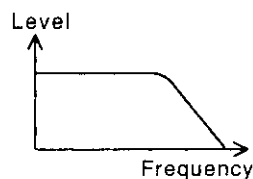

High Pass Filter (HPF)

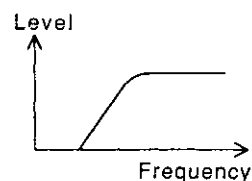

By setting filter 1 to HPF and filter 2 to LPF, you can create a Band Pass Filter that passes only a central band of frequencies.

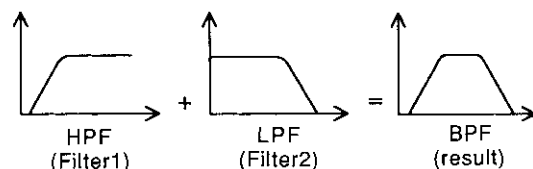

Each of the SY77's filters has a slope of 12 dB/octave. This means that if the cutoff frequency of a LPF is 1 kHz, frequencies at 2 kHz will be reduced by 12 dB and frequencies at 4 kHz will be reduced by 24 dB. If you set both filters 1 and 2 to LPF, set both to the same cutoff frequency, and set both filter EGs in the same way, the result will be the equivalent of a single 24 dB/octave filter. The filter copy function explained in *8.0 Copy filter* is a quick way to give both filters the same settings.

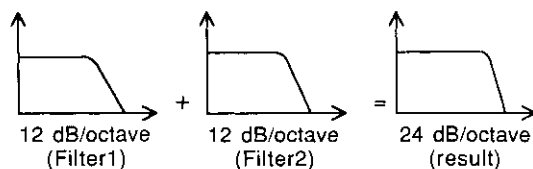

24 dB/octave filtering creates a sharp cutoff which is quite obvious, while 12 dB/octave filtering is a more subtle effect. Analog synthesizers of the past have used both types. 12 dB/octave filtering was considered especially suitable for strings, and 24 dB/octave filtering was for brass or synth bass sounds.

**Resonance:** Resonance lowers the level of sound below the cutoff frequency, creating an increased peak of emphasis. (This may reduce the overall volume.) High settings of resonance will make changes in cutoff frequency quite easy to notice. When the two filters are being used in tandem as a Band Pass Filter (i.e., when filter 1 is set to HPF), resonance will have no effect.

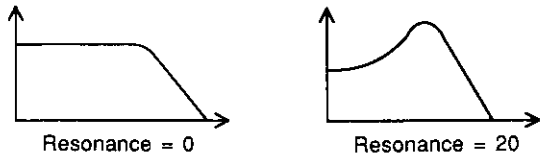

Extremely high settings of filter resonance will make the filter oscillate so that it produces a pitch of its own. This is a technique often used on analog synthesizers of the past.

**Ctrl = LFO:** When Ctrl is set to LFO, the filter will be controlled both by the Main LFO and by the controller which has been assigned to Filter Cutoff Depth. (Refer to *Voice common data 12. (F4) Controller.*) Key velocity will shift the cutoff frequency.

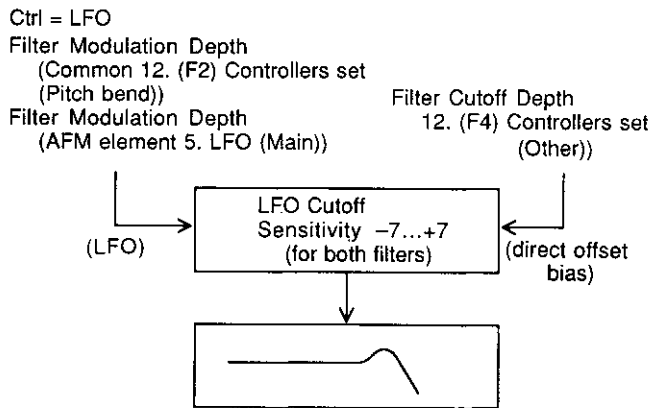

**Ctrl = EG:** When Ctrl is set to EG, the filter will be controlled by its own filter EG as explained in the following section 8.3 *Filter EG*. If Velocity Sense is set to a value other than 0, key velocity will shift the overall offset of the EG. The position of the controllers assigned to Filter Modulation Depth and Filter Cutoff Depth will be sampled at the beginning of the note (key on), but will have no effect *during* the note.

**Ctrl = EG-VA:** When Ctrl is set to EG-VA (EG voice attack), the filter will be controlled by its own filter EG as explained in the following section 8.3 *Filter EG*. If Velocity Sense is set to a value other than 0, key velocity will modify L1 (level 1) and R1 (rate 1) of the filter EG.

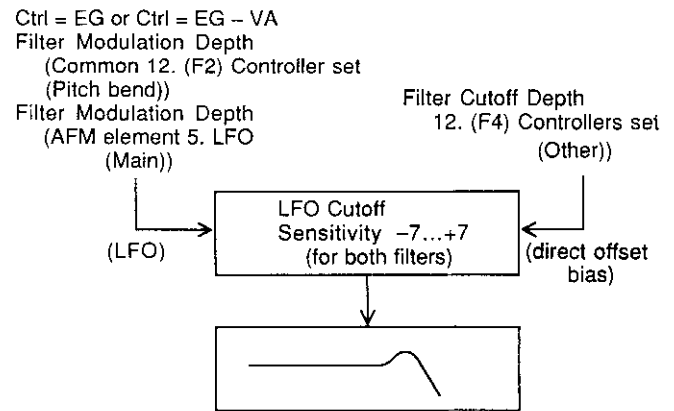

**Note:** When Ctrl=EG or Ctrl=EG-VA, the effect of the controller on the cutoff frequency will be fixed when the note is played. Moving the controller after playing the note will have no effect.

AFM ELEMENT DATA / AFM FILTER JUMP #250

## 8.2 Cutoff scaling

**Summary:** The cutoff frequency of each filter can be adjusted across the keyboard.

**Procedure:**

- From: AFM element job (JUMP #248)
- directory 8. AFM filter
- Select: 02:Cutoff Scaling
- filter 1 press F1 (Flt1) (JUMP #250)
- filter 2 press F2 (Filt2) (JUMP #251)
- Specify: filter scaling parameters

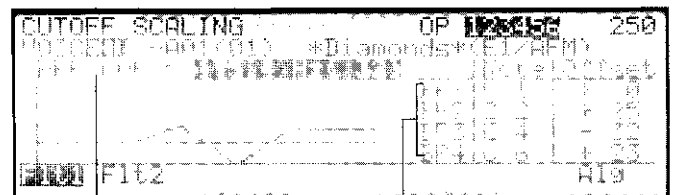

## VOICE EDIT MODE

- ❶ This indicates the type of the filter being edited, and its cutoff frequency. The cutoff frequency can be modified from this job, but to modify the type of filter you must use job 8.1 *Filter cutoff*.
- ❷ BP1-4 (Break Point): Note (C-2...G-8) and Offset (-127...+127) of each Break Point determine how the cutoff frequency level of the filter will vary across the keyboard. When the cursor is located at note, you can press F7 (Kbd) and press a key to enter the new note setting.

**Break Point:** The filter cutoff frequency can be made to vary depending on the note that is played. On most acoustic instruments, notes differ in tone depending on the range in which they are played.

Use the four break points to specify how the filter cutoff frequency will be adjusted across the keyboard. Offset (-127...+127) determines how the cutoff frequency will be adjusted at each of the four points specified by Note (C-2...G-8).

The four note settings must be in ascending order. It is not possible to set a break point to a note lower or higher than the note settings of the neighboring break points.

The following diagram shows how the filter cutoff frequency would be adjusted across the keyboard.

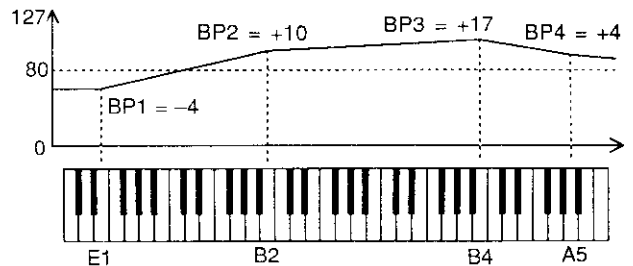

The offset at each break point is added to the cutoff frequency of 80. For example the offset at break point 1 (E1) is -4, so the resulting cutoff frequency at E1 is 76. The resulting cutoff frequency is limited to the range of 0...127.

AFM ELEMENT DATA / AFM FILTER

## 8.3 Cutoff EG

JUMP #252

**Summary:** The cutoff frequency of each filter can be moved over time by its own EG to make the tone change.

**Procedure:**

From: AFM element job directory (JUMP #248)  
8. AFM filter

- Select: 03:Cutoff EG
- filter 1 rates press (JUMP #252)  
F1 (Flt1), F3 (Rate)
  - filter 1 levels press (JUMP #253)  
F1 (Flt1), F4 (Lvl)
  - filter 2 rates press (JUMP #254)  
F2 (Flt2), F3 (Rate)
  - filter 2 levels press (JUMP #255)  
F2 (Flt2), F4 (Lvl)

Specify: filter EG parameters

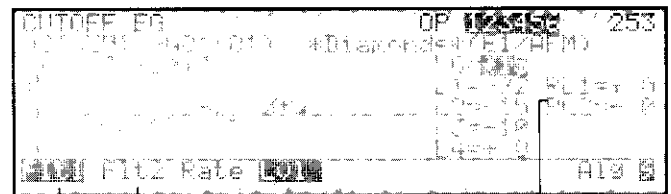
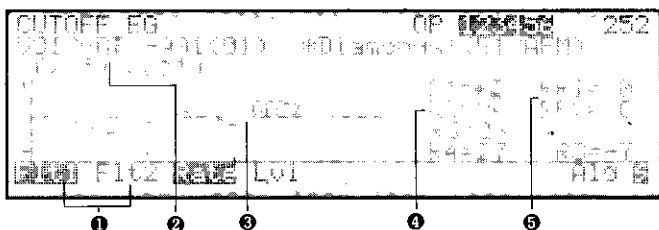

- ❶ This indicates whether you are editing the EG of filter 1 or 2.
- ❷ This indicates the displayed segment and range of the EG graphic display. To change the display range, hold SHIFT and press F1-F6 (x1, x2, x5, x10, x20, x50). To shift the display to a different segment, hold SHIFT and press F7 or F8 (Seg1...Seg4, Rel1).
- ❸ The filter EG is graphically displayed.
- ❹ R1-R4, RR1-RR2 (Keyon Rates, Release Rates 0...63): Keyon Rates 1-4 and Release Rates 1-2 determine the speed of the filter EG. Higher settings result in faster change.

- ⑤ RS (Rate Scaling -7...+7): Rate Scaling allows the filter EG rates to be increased or decreased depending on the key that is played. For positive settings the EG rates will increase as you play higher notes, resulting in shorter envelopes. For negative settings the EG rates will decrease as you play higher notes, resulting in longer envelopes.
- ⑥ L0-L4, RL1-2 (Keyon Levels, Release Levels -64...+63): Keyon Levels 0-4 and Release Levels 1-2 determine how the filter EG will increase or decrease the cutoff frequency specified for the filter.

**Rates and Levels:** The levels of the filter EG do not directly determine the cutoff frequency of the filter, but rather *adjust* the filter cutoff frequency you set in *8.1 Filter cutoff*.

When a note is played, the filter cutoff will be adjusted by the amount of L0, and will change at the rate of R1 to level L1. When the level reaches L1, it will change at the rate of R2 to the level of L2. When the level reaches L2, it will change at the rate of R3 to the level of L3. When the level reaches L3, it will change at the rate of R4 to the level of L4. The filter cutoff frequency will remain at the level of L4 as long as you continue pressing the key.

When you release the key, the filter cutoff frequency will change at the rate of RR1 to the level of RL1. When the level reaches RL1, it will change at the rate of RR2 to the level of RL2.

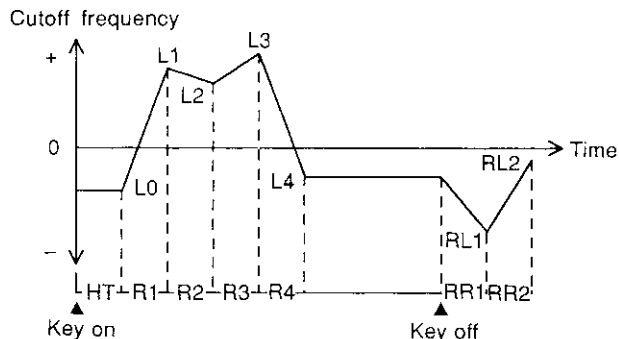

**Rate Scaling:** On most acoustic instruments, high notes have a naturally shorter attack and decay. This can be simulated by setting rate scaling to a positive value (+1...+7). The following diagram shows how higher notes will have faster rates (shorter EGs). Negative settings will have the opposite effect.

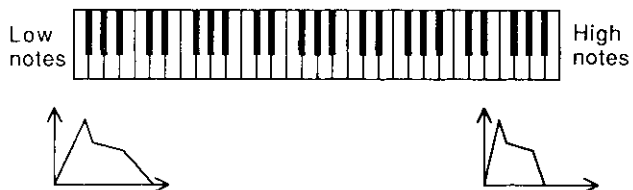

AFM ELEMENT DATA

## 15. Initialize AFM element

**Summary:** Initialize the AFM element data being edited to a set of basic values.

**Procedure:**

From: AFM Element job (JUMP #230) directory

Select: job 15:Initlz

To execute: the initialize operation press YES

To quit: without executing press NO or EXIT

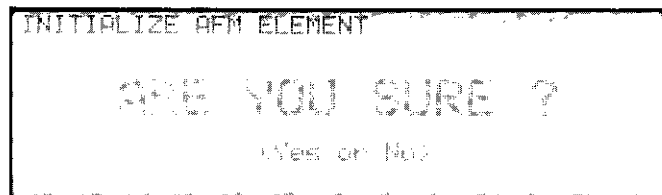

This function sets all AFM element data values to the minimum or simplest possible setting. When creating your own new voices it is usually best to begin by editing an existing voice. However if you want to start from scratch, this Initialize function can be helpful.

If you are sure you want to initialize the AFM element data, press YES. The AFM element data being edited will be set to the values shown below. If you decide not to initialize, press NO or EXIT.

This function initializes only AFM element data. Other initialize functions are provided for initializing Voice Common data and AWM element data. Refer to *Voice Common 15. Initialize voice* or *AWM element 15. Initialize AWM element*.

## VOICE EDIT MODE

### Initialized settings for AFM element data

01 Algorithm Set	
Algorithm number	= 30
Feedback 1	= none (free)
Feedback 2	= none (free)
Feedback 3	= none (free)
Input Level 1	= 7 (operator 1-5)
Input Level 1	= 0 (operator 6)
Input Level 2	= 0 (all operators)
Noise	= Off (all operators)
AWM Wave	= Off (all operators)
02 Operator Oscillator (all operators)	
Freq.Mode	= Ratio
Freq	= 1.00
Detune	= $\pm 0$
Waveform	= 1 (sine)
Phase Sync	= On
Init Phase	= 0
03 Operator EG (all operators)	
Keyon Hold Time	= 0
Keyon Rates 1-4	= 63
Keyoff Rates 1-2	= 63
Rate Scaling	= $\pm 0$
Keyon Level 0	= 0
Keyon Levels 1-4	= 63
Keyoff Levels 1-2	= 0
Loop Point	= S4
04 Operator Output	
Output Level	= 127 (operator 1)
Output Level	= 0 (operators 2-6)
Break Point 1 Note	= C1
Break Point 2 Note	= G2
Break Point 3 Note	= E4
Break Point 4 Note	= C6
Break Point Levels	= 0 (break points 1-4)
05 Operator Sensitivity (all operators)	
Keyon Velocity Sens	= 0
Rate Velocity Switch	= off
AMS	= 0
PMS	= 3

### 06 LFO

Main LFO	
Wave	= triangle
Speed	= 35
Delay Time	= 0
AMD, PMD, FMD	= 0
Init Phase	= 0
Sub LFO	
Mode	= delay
Wave	= triangle
Speed	= 80
Time	= 0
PMD	= 0

### 07 Pitch EG

Operator On/Off	= on (all operators)
Rate Scaling	= $\pm 0$
Velocity Switch	= off
Range	= 8 oct
Keyon Rates 1-3	= 63
Keyoff Rate 1	= 63
Keyon Levels 1-3	= $\pm 0$
Keyoff Level 1	= $\pm 0$

### 08 Filter

Resonance	= 0
Cutoff Mod Sens	= $\pm 0$
Keyon Velocity Sens	= $\pm 0$
*** following data is same for both filters ***	
Filter Type	= thru
Filter Control	= LFO
Cutoff Frequency	= 127
Break Point 1 Note	= C1
Break Point 2 Note	= G2
Break Point 3 Note	= E4
Break Point 4 Note	= C6
Break Point Offset	= 0 (BP 1-4)
Keyon Rates 1-4	= 63
Keyoff Rates 1-2	= 63
Rate Scaling	= $\pm 0$
Keyon Levels 0-4	= $\pm 0$
Keyoff Levels 1-2	= $\pm 0$



AFM ELEMENT DATA

## 16. Recall voice

**Summary:** Recall all data of the previously edited voice.

**Procedure:**

From: AFM Element job (JUMP #230)  
directory

Select: job 16:Recall voice

To execute: the recall operation press YES

To quit: without executing press NO or EXIT.

*Note: This operation recalls all voice data, not just AFM element data, and is also available while editing Common data, AWM Element data, or Drum Set data. For details refer to Voice Common 16. Recall.*

## AWM element data

AWM ELEMENT DATA

### AWM element job directory

JUMP #256

**Summary:** This directory shows the jobs which edit AWM element data.

**Procedure:**

From: voice edit mode (JUMP #200 or #201)

When: editing a normal voice that contains AWM elements

Select: an AWM element F3–F6 (JUMP #256)  
(E1–E4)

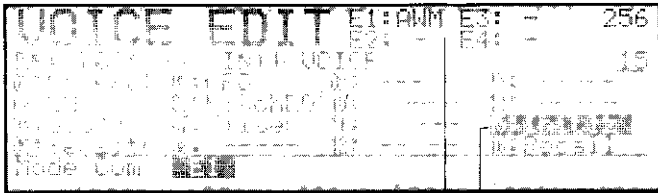

① ②

- ① This area shows the number (E1–E4) and type (AFM or AWM) of elements in the selected voice mode.
- ② Move the cursor in this area to select a job and press ENTER to go to the selected job.

**01:WaveSet (AWM waveform set):** Select an AWM sampled waveform from internal memory or a WAVEFORM card, and specify the pitch at which it will sound.

**02:EG (AWM EG):** The AWM Amplitude EG determines how the volume of each note will change over time.

**03:Output (AWM output):** The output level of an AWM element can be adjusted across the keyboard.

**04:Sensitiv (AWM sensitivity):** Key-on velocity can affect the volume or the speed of attack and decay. The control signal from the AWM LFO can create vibrato, tremolo, or wah-wah.

**05:LFO (AWM LFO):** The AWM element LFO creates a cyclically changing control signal that can be used for tremolo, vibrato, or wah-wah.

**06:PitchEG (AWM pitch EG):** The pitch of each note can be made to change in a fixed way over time.

**07:Filter (AWM filter):** The tone of an AWM element can be made to change in a fixed way over time, or can be controlled by a controller or the LFO.

**15:Initz (Initialize AWM element):** When you are creating a voice from scratch, it is sometimes convenient to set all AWM element data to the basic or minimum values.

**16:Recall (Recall voice):** All data of the previously edited voice can be recalled.

AWM ELEMENT DATA

## Copy element

**Summary:** While editing any AWM parameter (except for 7. AWM filter), you can copy data from an AWM element of another voice into the AWM element you are now editing.

**Procedure:**

From: AWM element job 1, 2, 3, 4, 5, or 6

Press: COPY

Press: F1 (Src) and select the source voice

Press: F2 (Elem) and select the source element

To execute: the copy operation press F8 (Go).

- This copy operation is identical to the operation explained in *AFM element data, Copy element* (page 117). Please refer to that section for details.
- This copy operation is possible only while *inside* one of the AWM editing jobs. It is not available from the AWM job directory.

AWM ELEMENT DATA

## 1. AWM waveform set

JUMP #257

**Summary:** Select an AWM waveform and specify the pitch at which it will sound.

**Procedure:**

- From: AWM Element job (JUMP #256)  
 directory  
 Select: job 01:WaveSet (JUMP #257)  
 Specify: the waveform and frequency

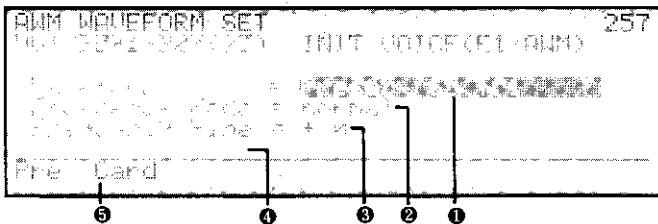

- ① **Waveform (Preset 1...112, Card 1...??, AFM):** Select an AWM waveform from internal presets 1...112. Refer to *Preset waveforms* below. If a waveform card is inserted into the WAVEFORM slot, you will also be able to select Card waveforms. The number of card waveforms will depend on each card. If the voice mode includes both AWM and AFM elements, you will be able to select AFM as well. For details see *Waveform = AFM* below.
- ② **Frequency Mode (normal, fixed):** When this is set to “normal”, each note of the keyboard will play the selected waveform at a different pitch. When this is set to “fixed”, the waveform will be played back at the pitch specified by ④ Note Number regardless of which note was played.
- ③ **Frequency Fine (-64...+63):** For both normal and fixed modes, this adjusts the fine pitch of the waveform.
- ④ **Note Number (C-2...G8):** The note number setting will appear only if frequency mode is set to “fixed”. This determines the pitch at which the selected waveform will be played back. When the cursor is located at Note Number, you can press F8 (Kbd) and then press a key to specify the note number.

- Pressing COPY while editing 7. *AWM filter* will access the Copy Filter operation. For details, refer to *AFM element data, 8.0 Copy filter*, page 131.

- ⑤ Pressing F1 (Pre) will select preset waveforms, F2 (Card) will select card waveforms, and pressing F3 (AFM) will select the sound from the AFM element if the voice includes an AFM element.

**Note when using card waveforms:** Remember that it is not possible to use two waveform cards at once. If the same Multi uses two or more AWM voices which use AWM waveforms from different cards, at least one AWM voice will be using the wrong waveform. In the same way, it is not possible for two AWM elements in a single voice to use AWM waveforms from different cards.

**Waveform = AFM:** For voice modes 09:1AFM&1AWM and 10:2AFM&2AWM, you have the option of setting “Waveform = AFM”. When this is selected, the output from the AFM element will be used instead of a AWM waveform. This means that the AFM sound will be processed through the two filters of the AFM element and also through the two filters of the AWM element, allowing you to create complex filtering effects.

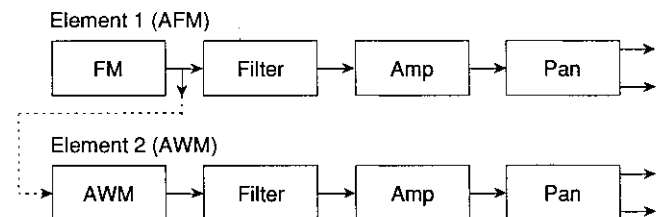

When “Waveform = AFM” is selected, the AWM element common data (note shift, etc.) and AWM pitch-related data such as pitch EG and LFO pitch modulation will be ignored. The result is essentially a single AFM element processed through two pairs of filters.

## VOICE EDIT MODE

**Preset waveforms:** The preset waveforms in ROM can be broadly divided into the following six categories.

**Multi-sampled** Acoustic instruments sampled at two or more points across the keyboard to preserve the realism of the original sound.

1	Piano	18	Thumping
2	Trumpet	19	Popping
3	Mute Tp	20	Fretless
4	Horn	21	Wood Bass
5	Flugel	22	Shamisen
6	Trombone	23	Koto
7	Brass	24	Violin
8	Flute	25	Pizz
9	Clarinet	26	Strings
10	Tenor Sax	27	AnlgBass
11	Alto Sax	28	Anlg Brs
12	GtrSteel	29	Chorus
13	EG Sngl	30	Itopia
14	EG Humbk	31	Vib
15	EG Harmo	32	Marimba
16	EG mute	33	Tubular
17	E.Bass		

**Waves** Fairly short samples, especially useful when used with an AFM element. Most are sampled at one point.

34	Cele Wv	46	12Str Wv
35	HarpsiWv	47	Bass Wv
36	E.P. Wv	48	Cello Wv
37	Pipe Wv	49	ContraWv
38	Organ Wv	50	Xylo Wv
39	Tuba Wv	51	Glock Wv
40	Picco Wv	52	Harp Wv
41	S.Sax Wv	53	Sitar Wv
42	BassonWv	54	StlDrmWv
43	Reco Wv	55	MtReedWv
44	MuteTpWv	56	OhAttack
45	Gut Wv		

**Oscillator** Basic waveforms such as the sawtooth or square waves used in analog synthesizers.

57	AnlgSaw1	62	Pulse 10
58	AnlgSaw2	63	Pulse 25
59	Digital1	64	Pulse 50
60	Digital2	65	Tri
61	Digital3		

**Transients** Short samples that are especially useful when used as the attack of a sound.

66	Piano Np	72	Bottle 3
67	E.P. Np	73	Tube
68	Vibe Np	74	Vocal Ga
69	DmpPiano	75	Vocal Ba
70	Bottle 1	76	Sax trans
71	Bottle 2	77	Bow trans

**Other** Various waveforms usable as sound effects or as part of other sounds.

78	Bulb	86	Steam
79	Tear	87	Narrow
80	Bamboo	88	Airy
81	Cup Echo	89	Styroll
82	Digi Atk	90	Noise
83	Temp Ra	91	Bell mix
84	Giri	92	Haaa
85	Water		

**Drumset** Drums and other rhythm instruments. These can be used not only in a Drum Set voice, but also as the waveform for an AWM element of a normal voice.

93	BD1	103	Tom 2
94	BD2	104	HHclosed
95	BD3	105	HH open
96	BD4	106	Crash
97	SD1	107	Ride
98	SD2	108	Claps
99	SD3	109	Cowbell
100	SD roll	110	Tambrn
101	Rim	111	Shaker
102	Tom 1	112	Analg Perc

## 2. AWM EG

**Summary:** This determines how the volume of an AWM element will change over time.

**Procedure:**

- From: AWM Element job (JUMP #256)  
directory
- Select: job 02:EG. (JUMP #258)
- Specify: volume EG parameters

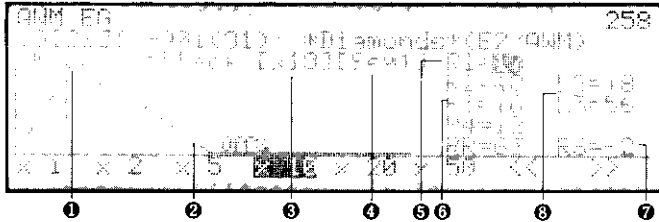

- 1 EG Mode (Mode = hold, attack): This setting determines whether the first segment of the AWM EG will begin from level 0 (attack mode) or from from maximum level (hold mode).
- 2 The AWM EG is graphically displayed.
- 3 This indicates the time range of the EG graphic display; "x1" displays the shortest time with the greatest detail. To change the time range, press F1-F6 (x1, x2, x5, x10, x20, x50).
- 4 This indicates the segment from which the EG is displayed. To begin the graphic display from a different segment, press F7 or F8 to select Seg1...Seg4 or Rel1.
- 5 Hold Time or Rate 1 (HT=63...0 or R1=0...63): If the EG Mode is set to "hold" this will determine the Hold Time for which the level of the waveform is held at maximum. A setting of HT=63 results in the longest time. If the EG Mode is set to "attack" this will determine Rate 1 of the EG. A R1 setting of 63 results in the fastest attack.
- 6 Keyon Rate 2-4, Release Rate (R2-R4 = 0...63, RR = 0...63): These settings determine the speed of the operator EG. Higher values result in faster change.
- 7 Rate Scaling (RS = -7...+7): Rate Scaling allows the operator EG rates to be increased or decreased depending on the key that is played. For positive settings the EG rates will increase as you play higher notes, resulting in shorter envelopes. For negative settings the EG rates will decrease as you play higher notes, resulting in longer envelopes.

- 8 Keyon Levels 2-3 (L2-L3 = 0...63): These determine the levels of the AWM EG. There is no L1 setting since the AWM EG either begins from 0 and moves toward maximum level (in attack mode), or begins at maximum level and stays there until the hold time has elapsed (hold mode). Nor is there a L4 setting since the level of the AWM EG immediately begins to move toward 0 after reaching L3. If you want the sound to continue sustaining as long as you press a key, set R4 to 0. However some AWM waveforms naturally decay to zero, so setting R4 to 0 will not make these waveforms sustain.

**Rates and Levels:** The AWM EG will function in two ways depending on the Mode setting.

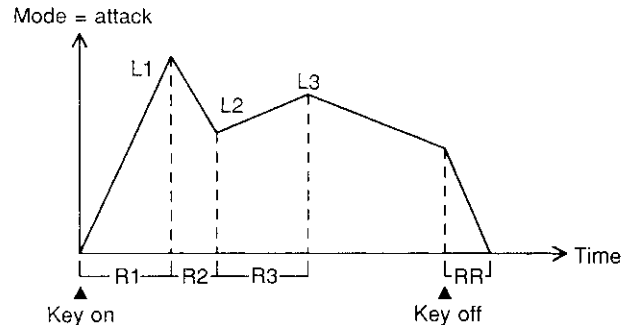

In normal mode the AWM EG level will begin from 0 and rise at the rate of R1 to maximum level. When maximum level is reached it will move at the rate of R2 to level L2. When level L2 is reached it will move at the rate of R3 to level L3. When level L3 is reached it will begin moving at the rate of R4 to 0. (If rate R4 is 0, the sound will move at an infinitely slow rate toward zero; i.e., it will sustain at level L3 as long as the key is pressed.)

When you release the key, the level will move at the rate of RR to a level of 0.

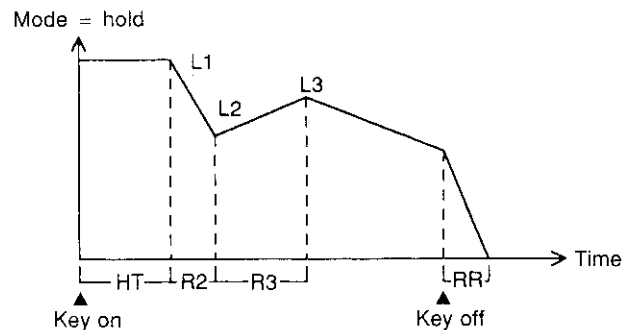

## VOICE EDIT MODE

In hold mode the AWM EG level will begin at maximum and stay there for the duration of the specified hold time HT. When the hold time has elapsed, the level will change at the rate of R2 to level L2. The rest of the EG is the same as for normal mode.

Using the AWM EG in hold mode is especially effective when you are using an AWM waveform which includes a definite attack. Keeping the level at maximum for a while allows the natural attack of the AWM sample to be heard. After the natural sampled attack is over the AWM waveform will continue sustaining, and you can use the remaining AWM EG parameters to create an appropriate decay and release.

**Rate 4 and Release Rate:** Rate 4 (R4) and Release Rate (RR) can be used in conjunction to create a variety of AWM EG shapes.

- If R4 is greater than 0 and you continue holding a note, after the level reaches L3 it will decrease at the rate R4 and will move to 0 even though you continue holding the note.

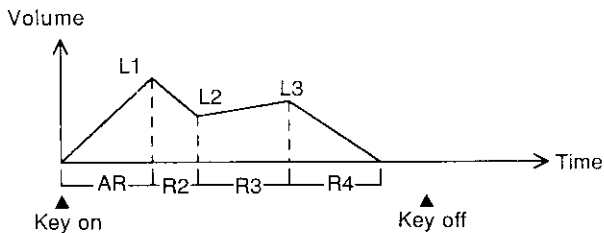

- If R4=0 and you continue holding a note, after the level reaches L3 it will stay at L3 as long as you hold the note. When you release the note, the level will decrease at the rate of RR to a level of 0.

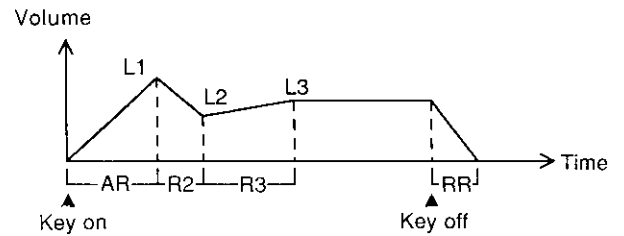

- After reaching L3 the level will decrease at the rate R4, but when you release the note the level will begin decreasing at the rate RR.

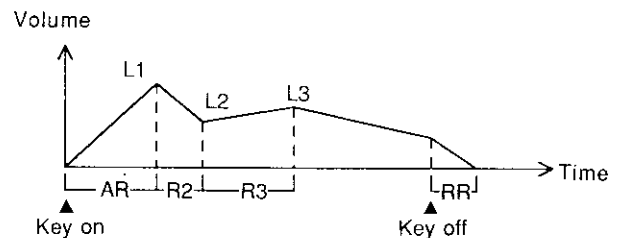

**Rate Scaling:** On most acoustic instruments, high notes have a naturally shorter attack and decay. This can be simulated by setting rate scaling to a positive value (+1...+7). The following diagram shows how higher notes will have faster rates (shorter EGs). Negative settings will have the opposite effect.

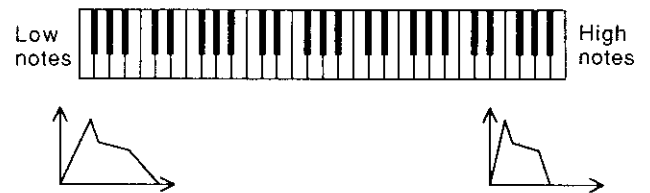

AWM ELEMENT DATA

### 3. AWM output

JUMP #259

**Summary:** The Element Level of an AWM element can be adjusted across the keyboard.

**Procedure:**

From: AWM Element job (JUMP #256)  
directory

Select: job 03:Output. (JUMP #259)

Specify: the output level scaling

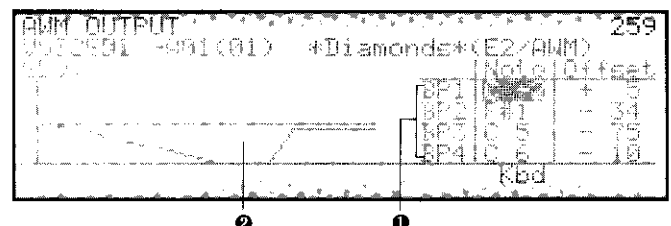

- ❶ Break Point 1-4 (BP1-4): Note (C-2...G8) and Offset (-127...+127) of each break point determine how the level specified in *Voice common data, 1. AWM element level* (JUMP #202) will be adjusted across the keyboard. When the cursor is located at note, you can press F7 (Kbd) and press a key to enter it as the new note setting.
- ❷ The keyboard level scaling is graphically displayed.

**Break Point:** The AWM Element Level can be adjusted according to the note that is played. On most acoustic instruments, notes differ in volume and tone depending on the range in which they are played. For example the low notes of a piano are louder than the high notes. Use the four break points to specify how the AWM element level will be adjusted across the keyboard. Offset (-127...+127) determines the output level adjustment for each of the four points specified by Note (C-2...G8).

The four note settings must be in ascending order. It is not possible to set a break point to a note lower or higher than the note settings of the neighboring break points.

The following diagram shows how the AWM element level would be adjusted across the keyboard for the settings shown in the above LCD.

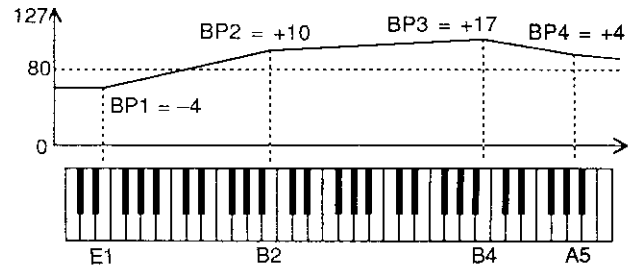

Each offset is added to the element level (80 in this example). For example the offset at break point 1 (E1) is -4, so the resulting element level at E1 is 76. The resulting element level is limited to the range of 0...127.

AWM ELEMENT DATA

## 4. AWM sensitivity

JUMP #260

**Summary:** These settings determine how the AWM element will be affected by key-on velocity and by the LFO.

**Procedure:**

- From: AWM Element job directory (JUMP #256)
- Select: job 04:Sensitiv (JUMP #260)
- Specify: sensitivity to velocity and modulation

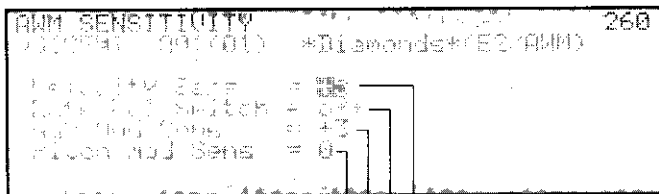

- ❶ Velocity Sensitivity (-7...+7): This determines how the output level of the AWM element will be affected by key-on velocity. For positive settings (+1...+7) the output level will increase as you play more strongly. For negative settings (-1...-7) the output level will decrease as you play more strongly. For negative settings to have an effect the element level must be lowered.

- ❷ Rate Velocity Switch (on, off): When the Rate Velocity switch is on, key-on velocity will affect the AWM EG attack rate (R1). The effect will depend on the Velocity Sensitivity setting.
  - Velocity = +1...+7: If Rate Velocity is on, strongly played notes will cause the AWM R1 to increase, resulting in a faster attack. For the strongest possible velocity, the EG attack will change at the speed specified by the EG R1 setting.
  - Velocity = -1...-7: If Rate Velocity is on, strongly played notes will cause the AWM R1 to decrease, resulting in a slower attack. When the Rate Velocity switch is off, the AWM EG attack rate will not be affected by key-on velocity.
- ❸ Amplitude Modulation Sensitivity (Amp Mod Sens = -7...+7): Amplitude Modulation Sensitivity determines how greatly the output level of the AWM element will be affected by Amplitude Modulation from the LFO. Increasingly higher positive settings (+1...+7) will allow the LFO to have a greater effect.

Negative settings (-1...-7) are effective only for EG Bias. When Amplitude Modulation Sensitivity is set to a negative value, the controller assigned to EG Bias by the setting in *Voice common data, 12. (F4) Controller set* (JUMP #228) will decrease the amplitude of the AWM element, and the LFO will have no effect. For example, two AWM elements in a voice might be given opposite Amplitude Modulation Sensitivity settings, so that the controller assigned to *EGbiasDepth* would crossfade between the two elements.

- ④ Pitch Modulation Sensitivity (Pitch Mod Sens = 0...7): Pitch Modulation Sensitivity determines how greatly the pitch of the AWM element will be affected by Pitch Modulation from the LFO.

**Amplitude Modulation Sensitivity and Pitch Modulation Sensitivity:** These settings determine the *sensitivity* of the AWM element to the Amplitude Modulation Depth (AMD) and/or Pitch Modulation Depth (PMD) produced by the AWM element LFO. If the LFO settings for AMD and/or PMD are set to 0, these settings will have no effect.

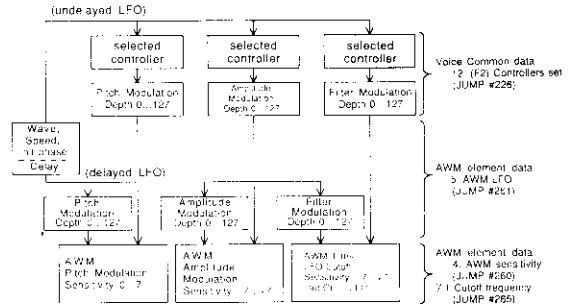

AWM ELEMENT DATA

## 5. AWM LFO

JUMP #261

**Summary:** The AWM element LFO creates a cyclically changing control signal that can be used to create tremolo (Amplitude modulation), vibrato (pitch modulation), and wah-wah (filter modulation).

**Procedure:**

- From: AWM Element job directory (JUMP #256)
- Select: job 05:LFO (JUMP #261)
- Specify: the LFO parameters

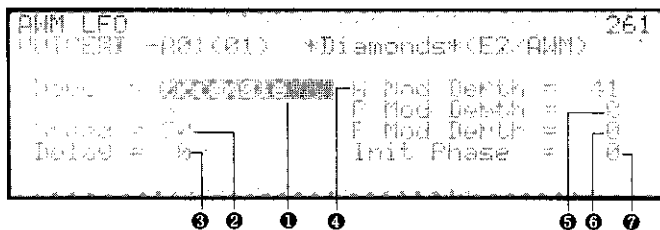

- ① Wave (triangle, saw down, saw up, square, sine, sample&hold): This selects the wave (shape of modulation) produced by the AWM LFO. The selected wave is graphically displayed in the LCD. When sample&hold is selected, the LFO will produce a control signal whose level will change randomly at intervals of time determined by the Speed setting.
- ② Speed (0...99): The speed of the LFO modulation. Higher settings result in faster modulation.

- ③ Delay (0...99): The time delay before the LFO modulation begins.
- ④ Amplitude Modulation Depth (0...127): This determines how greatly the LFO will affect the output level (amplitude) of the operators.
- ⑤ Pitch Modulation Depth (0...127): This determines how greatly the LFO will affect the pitch of the operators.
- ⑥ Filter Modulation Depth (0...127): This determines how greatly the LFO will affect the cutoff frequency of the filter.
- ⑦ Initial Phase (0...99): This determines the point of the LFO waveform from which the LFO will start each time a key is pressed.

**Wave, Speed, Delay, Initial Phase:** Detailed explanations and diagrams of these parameters are given in *AFM element job 6.1 LFO (Main)*.

**Amplitude Modulation Depth and Pitch Modulation Depth:** For these setting to have an effect, the AModSens (amplitude modulation sensitivity) or PModSens (pitch modulation sensitivity) of the AWM element must be set above 0. Make these settings in *AWM element job 4. AWM sensitivity* (JUMP #260).



**Filter Modulation Depth:** For this setting to have an effect, the Ctrl setting of a filter must be set to "LFO", and the LFO Cutoff Sens setting must not be 0. Make these settings in *AWM element data, 7.1 Cutoff frequency (JUMP #265)*.

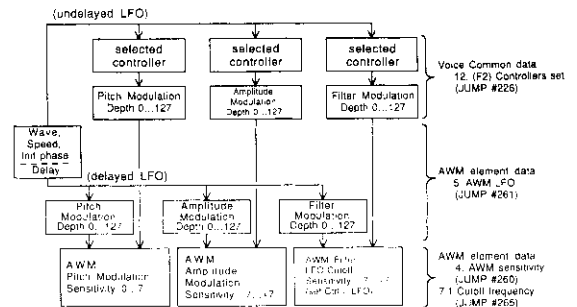

AWM ELEMENT DATA **6. (F1) AWM pitch EG (Data)** JUMP #262

**Summary:** The pitch change over time created by the pitch EG can be affected by key-on velocity and the speed of pitch change can be adjusted across the keyboard. To set the shape of the pitch EG, see 6. (F2) AWM pitch EG (EG).

**Procedure:**

- From: AWM Element job (JUMP #256) directory
- Select: job 06:PitchEG and press (JUMP #262) F1 (Data)
- Specify: pitch EG scaling, velocity, and range

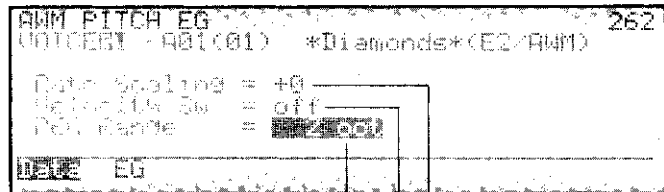

- 1 Rate Scaling (-7...+7): Pitch EG Rate Scaling determines how pitch EG rates will change according to the note played. When this is set to +1...+7, the pitch EG will be faster for higher notes. When this is set to -1...-7, the pitch EG will be slower for higher notes. When this is set to 0, the pitch EG will be the same rate for all notes.
- 2 Velocity Sw (off, on): When this is on, strongly played notes will change in pitch more than softly played notes.

3 Range (1/2 oct, 1 oct, 2 oct): This determines the maximum range of the AWM pitch EG, from 1/2 octave to 2 octaves. (Note that the 8 octave range of the AFM pitch EG is not available for the AWM pitch EG.)

**Rate Scaling:** This setting determines how Pitch EG Rates (the speed of pitch change) will be affected by the key number of each note. The following diagram shows the result when Pitch EG Rate Scaling is set to +7. Notice that high notes have a shorter pitch EG (faster EG rates) than lower notes.

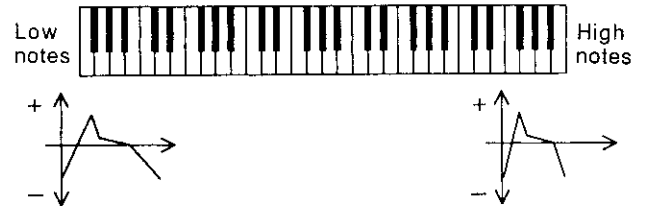

**Velocity Sw (velocity switch):** When this is on, strongly played notes will change in pitch more than softly played notes.

AWM ELEMENT DATA **6. (F2) AWM pitch EG (EG settings)** JUMP #263

**Summary:** The pitch EG creates a fixed shape of pitch change over time for each note. To adjust speed of pitch change across the keyboard, see 6. (F1) AWM pitch EG (Data).

**Procedure:**

- From: AWM Element job (JUMP #256) directory
- Select: job 06:PitchEG and press (JUMP #263) F2 (EG)
- Specify: pitch EG parameters

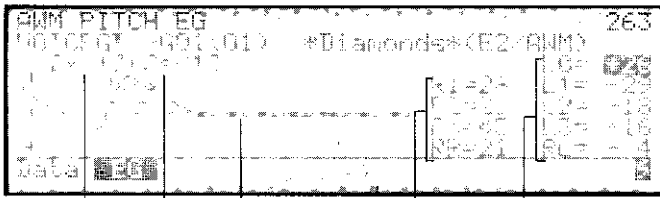

- ❶ This indicates the EG segment (“seg1-3” or “rel1”) from which the pitch EG graphic display begins. If the EG is too long to be fully shown in the LCD, hold SHIFT and press F7 or F8 to change the segment from which the display begins.
- ❷ This indicates the time length shown by the graphic display. To change this, hold SHIFT and press F1-F6 (x1, x2, x5, x10, x20, x50). The exact length of time will depend on the range. When the pitch EG range is 1 octave, the graphic display will cover approximately 0.5 seconds at “x1” and approximately 5 seconds at “x50”.
- ❸ The pitch EG is graphically displayed.
- ❹ R1-R3, RR1 (0...63): Keyon Rates 1-3 and the Release Rate determine the speed of the pitch EG. Higher settings result in faster change. A rate of 63 will jump immediately to the following level.

- ❺ L0-L3, RL (-64...+63): Keyon Levels 0-3 and the Release Level determine the levels of the pitch EG. Positive settings raise the pitch and negative settings lower the pitch.

**Rates and Levels:** When you press a key, the pitch will begin at the level of L0, and will change at the rate of R1 to level L1. When the level reaches L1, the pitch will change at the rate of R2 to the level of L2. When the pitch reaches L2, it will change at the rate of R3 to the level of L3 and will stay at L3 as long as the key is pressed.

When the key is released, the pitch will change at the rate of RR to the level of RL.

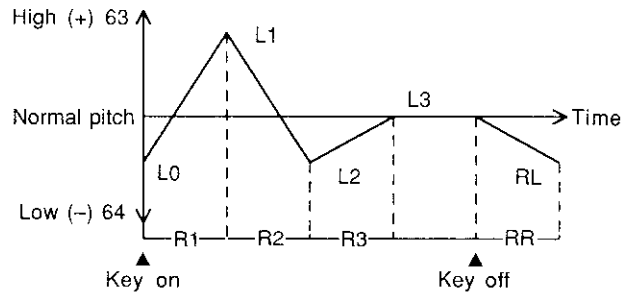

*Note: Even if the AWM pitch EG and the AFM pitch EG have identical Rate settings, there will be slight differences in the timing of the pitch change.*

AWM ELEMENT DATA

## 7. AWM filter

JUMP #264

**Summary:** The two filters of each element can be used to control the tone in various ways.

**Procedure:**

- From: AWM Element job (JUMP #256) directory
- Select: job 07:Filter (JUMP #264)
- Specify: the desired filter edit job and press ENTER

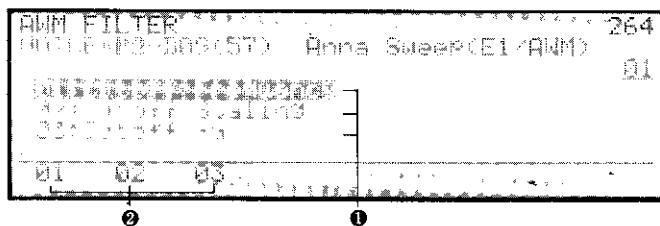

- ❶ Move the cursor in this area to select a job and press ENTER to move to the selected job.
  - 01: Cutoff Frequency: Make overall settings for the filters. (JUMP #265)
  - 02: Cutoff Scaling: Specify how each filter will be adjusted across the keyboard. (JUMP #266, #267)
  - 03: Cutoff EG: Specify how each filter will change over time. (JUMP #268, #269, #270, #271)
- ❷ Pressing F1-F3 will select the corresponding job.

*Note: Filter settings for an AWM element are exactly the same as for an AFM element. For details, refer to AFM element job 8. AFM filter.*

AWM ELEMENT DATA

## 15. Initialize AWM element

**Summary:** Initialize the AWM Element data being edited to a set of basic values.

**Procedure:**

From: AWM Element job (JUMP #256) directory

Select: job 15:Initlz

To execute: the initialize operation press YES

To quit: without initializing press NO or EXIT

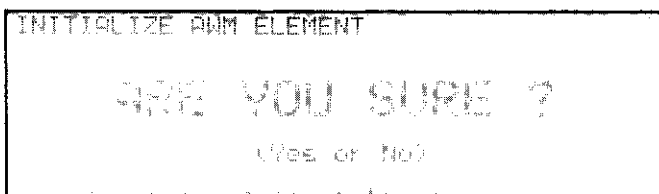

This function sets all AWM element data values to the minimum or simplest possible setting. When creating your own new voices it is usually best to begin by editing an existing voice. However if you want to start from scratch, it is often useful to start from an initialized setting rather than having to reset all the parameters.

If you are sure you want to initialize the AWM element data, press YES. The AWM element data being edited will be set to the values shown below. If you decide not to initialize, press NO.

This function initializes only AWM element data. Other initialize functions are provided for initializing Voice Common data and AFM element data. Refer to *Voice Common 15. Initialize* or *AFM Element 15. Initialize*.

### Initialized settings for AWM Element data

#### 01 AWM Waveform Select

Waveform = Preset 65  
(triangle wave)

Frequency Mode = normal

Fixed Mode Note # = C3

Frequency Fine =  $\pm 0$

#### 02 AWM Amplitude EG

Mode = normal

Keyon Rates 1, 2, 3 = 63

Keyon Rate 4 = 0

Keyoff Rate 1 = 63

Rate Scaling =  $\pm 0$

Keyon Level 2, 3 = 63

#### 03 AWM Output

Break Point 1 Note = C1

Break Point 2 Note = G2

Break Point 3 Note = E4

Break Point 4 Note = C6

BP1-4 Offset =  $\pm 0$

#### 04 AWM Sensitivity

Velocity Sens =  $\pm 0$

Rate Velocity Switch = off

AMS = 0

PMS = 3

#### 05 AWM LFO

Wave = Triangle

Speed = 65

Delay Time = 0

AMD, PMD, FMD = 0

Init Phase = 0

#### 06 AWM Pitch EG

Rate Scaling =  $\pm 0$

Velocity Switch = off

Range = 2 octaves

Keyon Rates 1-3 = 63

Keyon Levels 0-3 =  $\pm 0$

Keyoff Rate 1 = 63

Keyoff Level 1 =  $\pm 0$

## VOICE EDIT MODE

07 AWM Filter		Break Point 2 Note	= G2
Resonance	= 0	Break Point 3 Note	= E4
Cutoff Mod Sens	= $\pm 0$	Break Point 4 Note	= C6
Keyon Velocity Sens	= $\pm 0$	Break Point Offset	= 0 (BP 1-4)
*** following data is same for both filters ***			
Filter Type	= thru	Keyon Rates 1-4	= 63
Filter Control	= LFO	Keyoff Rates 1-2	= 63
Cutoff Frequency	= 127	Rate Scaling	= $\pm 0$
Break Point 1 Note	= C1	Keyon Levels 0-4	= $\pm 0$
		Keyoff Levels 1-2	= $\pm 0$

AWM ELEMENT DATA

## 16. Recall voice

**Summary:** Recall all data of the previously edited voice.

**Procedure:**

From: AWM Element job (JUMP #256)  
directory

Select: job 16:Recall

To execute: the recall operation press YES

To quit: without executing press NO or EXIT.

*Note: This operation recalls all voice data, not just AWM element data, and is also available while editing Common data, AFM element data, or Drum Set data. For details refer to Voice common data, 16. Recall voice.*

## Drum set data

DRUM SET DATA

### Drum set job directory

JUMP #272

**Summary:** This job directory shows the jobs containing data for a drum voice.

**Procedure:**

From: voice edit mode (JUMP #200)

When: the Voice Mode is set to 11:Drum Set

Select: the drum set job directory (JUMP #272)  
F2 (Com)

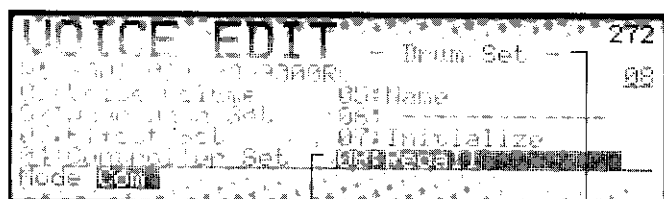

- ❶ This area indicates that “Drum Set” is the selected voice mode.
- ❷ Move the cursor in this area to select a job and press ENTER to go to the selected job.

- 01: Voice Volume: Adjust the overall volume of the entire drum voice.
- 02: Wave Data Set: Select a waveform for each key of the SY77's 61-note keyboard, and specify tuning and pan for each.
- 03: Effect Set: Specify how the four DSP effect units will be connected, select an effect type for each unit, and make settings for each effect.
- 04: Controller Set: The overall volume of a drum set voice can be adjusted using a specified controller.
- 05: Name: Specify a ten-character name for the voice being edited.
- 07: Initialize: Initialize the drum set data being edited to the basic or minimum settings.
- 08: Recall: Recall the previously edited voice into the editing buffer.

DRUM SET DATA

### 1. Voice volume

JUMP #273

**Summary:** Adjust the overall volume of the entire drum voice.

**Procedure:**

From: drum set job directory (JUMP #272)

Select: 01:Voice Volume (JUMP #273)

Specify: the volume of the entire drum set

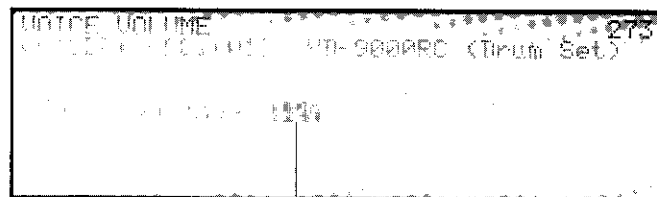

- ❶ Voice Volume (0...127): This determines the overall volume of the entire drum voice.

DRUM SET DATA 2. Wave data set JUMP #274

**Summary:** Select a waveform for each key of the SY77's 61-note keyboard, and specify tuning and pan for each.

**Procedure:**

- From: drum set job directory (JUMP #272)
- Select: 02:Wave Data Set (JUMP #274)
- Specify: parameters for each key note number

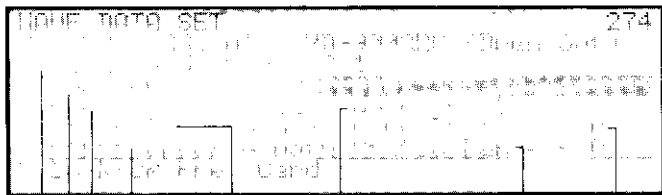

- 1 Key Note Number (C1...C6): Press a key on the SY77 keyboard to select a key note number, and it will be displayed here. (It is not possible to move the cursor here.)
- 2 Waveform (Preset 1...112, Card 1...??): Select the AWM sample that will be played by the corresponding Key Note Number. A list of the 112 preset waveforms is given in *AWM element edit, 1. AWM Waveform Set* (page 00).
- 3 Level (0...127): This determines the volume of the waveform.
- 4 Alternate (on, off): When this is "on" for two or more key note numbers, the last-played key will take priority and the waveform of the previously played key will be turned off.
- 5 Output Group (off, grp1, grp2, both): Select the output group from which the waveform selected for this key note number will be output.
- 6 Note Shift (-48...+36 in half steps): Adjust the tuning of the waveform in half steps.
- 7 Fine Tuning (-64...+63 in units of 1.171875 cents): Adjust the tuning of the waveform in fine steps.
- 8 Static Pan (-31...+31 = Left...Right): Specify the stereo position for each key note number.

Use the following two steps to make settings 2-8 for each note of the keyboard. Repeat the two steps as necessary.

1. Press a key on the SY77 keyboard to select a key note number. The selected key note number will be displayed in 1.
2. Make settings 2-8 for the selected key note number.

**Alternate:** If two or more waveforms would sound unnatural if they were played at the same time, select alternate "on" for each of these waveforms. For example it is impossible for a real drum set to sound the closed hi-hat and open hi-hat at the same time. By selecting alternate "on" for the two key note numbers that play the closed hi-hat and open hi-hat waveforms, playing the closed hi-hat will make the open hi-hat stop, and vice versa.

There is only one alternate group for the entire drum voice; i.e., it is not possible to specify two or more *pairs* of key note numbers to play alternately. You may select alternate "on" for as many key note numbers as you like but they will all be in the same alternate group, and only the one of them will sound at any time.

**Static Pan:** The stereo position of the waveform played by each key note number is determined by the static pan setting. The "dynamic" pan of AFM or AWM element can be moved over time by an EG or LFO, but the "static" pan for each key note number of a drum voice cannot be moved over time.

When using a drum set voice in a Multi, these static pan settings will be used if the multi static pan is set to "VC" (voice). Refer to *Multi edit, 5. Voice static pan*.

**Output Group:** The stereo signal from the static pan of each key note number is sent to output group 1, 2, or both. If output group is set "off" the waveform for that key note number will not be heard. The selected output group will determine how each waveform of the drum voice will be processed through the effect units.

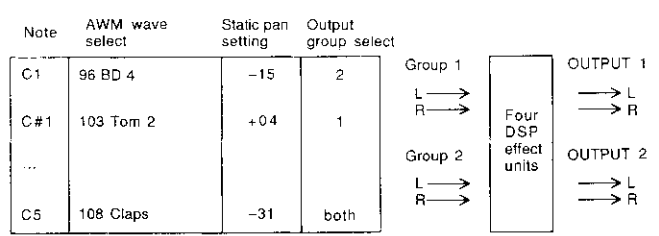

DRUM SET DATA

### 3. Effect set

JUMP #211

**Summary:** Specify how the four DSP effect units will be connected, select an effect type for each unit, and make settings for each effect.

**Procedure:**

From: drum set job directory (JUMP #272)  
 Select: 03:Effect Set (JUMP #211)  
 Specify: the effect job you wish to edit and press  
 ENTER

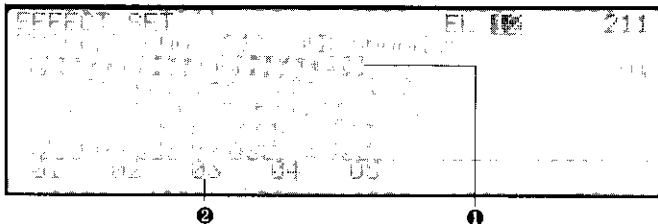

- ① Move the cursor in this area to select a job.
  - 01: Effect Mode Select: Specify how the four effect units will be connected. (JUMP #212)
  - 02: Modulation Effect 1 Set: Select an effect type and set parameters for modulation effect 1. (JUMP #213, #214)

03: Modulation Effect 2 Set: Select an effect type and set parameters for modulation effect 2. This is set in exactly the same way as explained for Modulation Effect 1. (JUMP #215, #216)

04: Reverb Effect 1 Set: Select an effect type and set parameters for reverb effect 1. (JUMP #217, #218)

05: Reverb Effect 2 Set: Select an effect type and set parameters for reverb effect 2. This is set in exactly the same way as Reverb Effect 1. (JUMP #219, #220)

- ② Pressing F1–F5 will select the corresponding job.

*Note: Effect settings for a drum set voice are made in exactly the same way as for a normal voice. For details on effect settings, refer to Common Data job 10. Effect set.*

DRUM SET DATA

### 4. Controller set

JUMP #275

**Summary:** The overall volume of a drum set voice can be adjusted using a specified controller.

**Procedure:**

From: drum set job directory (JUMP #272)  
 Select: 04:Controller Set (JUMP #275)  
 Specify: the minimum level and controller for drum  
 voice volume

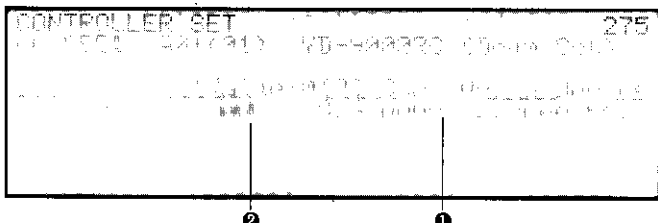

- ① Device (MIDI Control #): Select a controller number 0–120 or aftertouch. For example when “001 Modulation” is selected, the MODULATION 1 wheel will regulate the volume of the drum voice. For a detailed explanation of controller numbers, refer to *Voice Common job 12. (F2) Controllers.*

- ② Vol Low Limit (Value 0...127): This determines the lowest volume that can be set by the selected controller. For example when this is set to 80, the lowest position of the controller will set the volume of the drum voice to 80. When this is set to 0 the lowest position of the controller will reduce the volume of the drum voice to silence. When this is set to 127 the controller will have no effect on the volume.

**Remarks:** In addition to the controller specified here, the volume of the entire SY77 can always be controlled over its full range by an optional foot controller connected to the rear panel VOLUME jack.

## 5. Voice name

**Summary:** Specify a ten-character name for the voice being edited. In voice play mode this voice name will be displayed in large characters.

**Procedure:**

- From: drum set job directory (JUMP #272)
- Select: 05:Drum Set Name (JUMP #229)
- Specify: the drum voice name

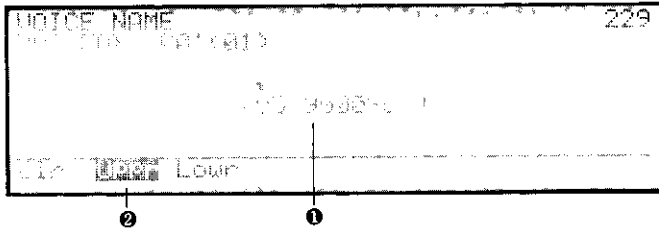

- ① Enter a ten-character name for the drum voice.
- ② To clear the currently entered name press F1 (Clr). To switch to upper-case characters press F2 (Uppr). To switch to lower-case characters press F3 (Lowr).

For a detailed explanation of how to enter character data, refer to *How to enter data* of the *Introductory* Section.

## 7. Initialize voice

**Summary:** Initialize the drum set data being edited to the basic or minimum settings.

**Procedure:**

- From: drum set job directory (JUMP #271)
- Select: 07:Initialize
- To execute: the initialize operation press YES
- To quit: without executing press NO or EXIT

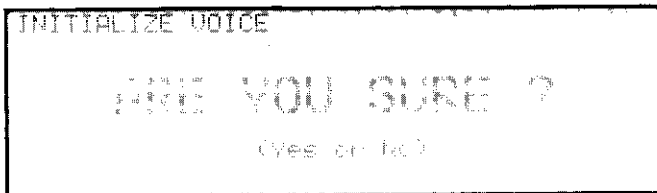

This function sets all drum set data to the basic or minimum settings. If you are creating an entirely new voice, using this initialize function may be faster than resetting all the parameters by hand.

If you are sure you want to initialize the drum set data press YES and the data will be set to the values shown below. If you decide not to initialize, press NO.

This function initializes only Drum Set data. Other initialize functions are provided for initializing Voice Common data, AFM Element data, or AWM Element data.

**Initialized settings for Drum Set data**

- 01 Voice volume = 127
- 02 Wave data set (for each Key Note Number)
  - Level = 127 (all key note numbers)
  - Output Group = both (all key note numbers)
  - Fine tuning = ±0 (all key note numbers)
  - Alternate = off (all key note numbers except A2 HI-HAT CLOSED and B2 HI-HAT OPEN)



Key note number	Waveform (preset)	Note shift	Static pan
C1	96 BASS DRUM 4	-5	±0
C#1	96 BASS DRUM 4	+5	±0
D1	95 BASS DRUM 3	-5	±0
D#1	95 BASS DRUM 3	+5	±0
E1	103 TOM 2	-9	+24
F1	103 TOM 2	-3	-8
F#1	103 TOM 2	+3	+8
G1	103 TOM 2	+9	+24
G#1	94 BASS DRUM 2	±0	±0
A1	93 BASS DRUM 1	±0	±0
A#1	99 SNARE DRUM 3	±0	±0
B1	102 TOM 1	-9	-24
C2	102 TOM 1	-3	-8
C#2	98 SNARE DRUM 2	±0	±0
D2	102 TOM 1	+3	-8
D#2	101 RIM SHOT	±0	+12
E2	97 SNARE DRUM 1	±0	±0
F2	102 TOM 1	+9	+24
F#2	108 CLAPS	±0	-12
G2	109 COWBELL	±0	-20
G#2	111 SHAKER	±0	+20
A2	104 HI-HAT CLOSED		±0
A#2	110 TAMBOURINE	±0	-10
B2	105 HI-HAT OPEN	±0	+24
C3	106 CRASH	±0	+10
C#3	100 SNARE DRUM ROLL	±0	±0
D3	107 RIDE	-4	-24
D#3	107 RIDE	+4	-24
E3	73 TUBE	-10	-26
F3	73 TUBE	-5	-20
F#3	73 TUBE	+5	-14
G3	82 DIGITAL ATTACK	-7	±0
G#3	82 DIGITAL ATTACK	+7	±0
A3	112 ANALOG PERCUSSION	-5	±0
A#3	112 ANALOG PERCUSSION	+5	±0
B3	77 BOW TRAN	-5	±0
C4	77 BOW TRAN	+5	±0
C#4	80 BAMBOO	±0	+20

Key note number	Waveform (preset)	Note shift	Static pan
D4	75 VOCAL "Ba"	-5	+24
D#4	75 VOCAL "Ba"	+5	+24
E4	83 TEMP RA	±0	±0
F4	71 BOTTLE 2	±0	±0
F#4	70 BOTTLE 1	±0	±0
G4	72 BOTTLE 3	±0	±0
G#4	81 CUP ECHO	±0	±0
A4	74 VOCAL "Ga"	-5	-24
A#4	74 VOCAL "Ga"	+5	-24
B4	79 TEAR	±0	±0
C5	59 OH ATTACK C	-12	±0
C#5	59 OH ATTACK C#	-11	±0
D5	59 OH ATTACK D	-10	±0
D#5	59 OH ATTACK D#	-9	±0
E5	59 OH ATTACK E	-8	±0
F5	59 OH ATTACK F	-7	±0
F#5	59 OH ATTACK F#	-6	±0
G5	59 OH ATTACK G	-5	±0
G#5	59 OH ATTACK G#	-4	±0
A5	59 OH ATTACK	-3	±0
A#5	59 OH ATTACK A#	-2	±0
B5	59 OH ATTACK B	-1	±0
C6	59 OH ATTACK C high	±0	±0

03 Effect set

\*\*\* same as normal voice initial data \*\*\*

04 Controller set

Volume Low Limit = 0  
Device = 14

05 Drum set name

Name = INIT VOICE

DRUM SET DATA

## 8. Recall voice

**Summary:** Recall all data of the previously edited voice.

**Procedure:**

From: drum set job directory (JUMP #271)  
Select: 08:Recall

To execute: the recall operation press YES

To quit: without executing press NO or EXIT.

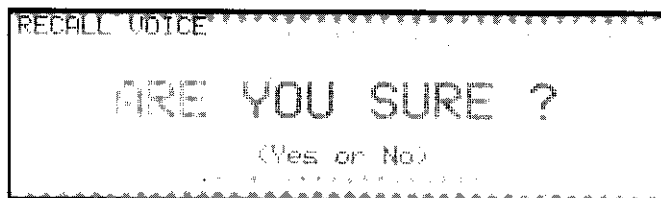

If after editing a voice you exit voice edit mode without storing, the edited voice data will be lost. In such cases you can use this function to recall the previously edited data into the editing buffer.

*Note: This operation recalls voice data, not just Drum Voice data, and is also available while editing Common data, AFM Element data, or AWM Element data. For details refer to Voice Common 16. Recall.*



# MULTI PLAY MODE

Multi mode allows the SY77 to function as sixteen completely independent synthesizers. In multi play mode you can do the following things.

- Select multis from preset, internal, or card memory.
- View a directory of the 16 multis in an internal, card, or preset memory.
- Copy the currently selected multi to any internal or card memory.
- Send a program change to an external device.

## MULTI PLAY MODE

Multi mode allows the SY77 to function as sixteen completely independent synthesizers, each being controlled on its own MIDI channel. Since the keyboard of the SY77 transmits only on one MIDI channel at a time, multi mode is meaningful only when you are using a sequencer (either the SY77's built-in sequencer or an external MIDI sequencer) to play the SY77's tone generator.

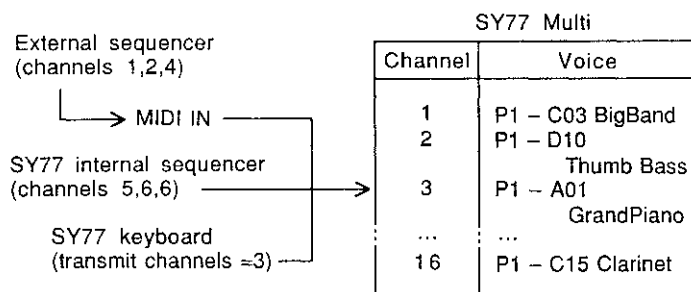

*Note: If a multi contains many two-element or four-element voices, the response to Note-on messages may become slightly slower. If this is a problem, either reduce the number of voices in the multi, or select voices which use fewer elements.*

## Multi select

JUMP #300

Press MULTI to enter multi play mode. The following LCD will appear.

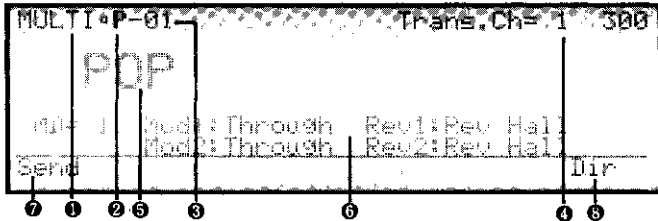

- ❶ MULTI: This indicates that you are in Multi Play mode.
- ❷ Multi memory (I, C, P): This indicates the multi memory; Internal, Card, or Preset. Preset memory contains only a single bank of 16 Multis. It makes no difference whether you press PRESET 1 or PRESET 2.
- ❸ Multi number (1–16): This indicates the number of the multi.
- ❹ Transmit channel (1–16): This indicates the MIDI transmit channel you selected in *MIDI Utility 1. Channel set*. The SY77 keyboard will transmit from MIDI OUT on this channel, and will play the corresponding channel of the Multi.
- ❺ The Multi name is displayed in large characters.

- ❻ Effect settings: The effect mode is indicated as “MD=”, and the type of effect selected by this multi is shown for each of the four DSP units; Modulation 1 and 2, and Reverb 1 and 2. For details refer to *Multi Edit Reference, job 7. Effect set*.
- ❼ Refer to the following section *Send Program Change*.
- ❽ Refer to the following section *Multi Directory*.

To select a multi use the following procedure. The multi does not actually change until you specify the number 1–16. If you want to play a different multi from the same multi memory, simply specify a different number 1–16.

1. Select the multi memory; INTERNAL, CARD (only if a card is inserted into the DATA slot), PRESET 1, or PRESET 2. The selected LED will blink.
2. Select a multi 1–16. The selected LED will light, and the LCD display will show the newly selected multi name.

## Multi directory

JUMP #301

**Summary:** While in multi play mode you can press F8 (Dir) to view a directory of the sixteen multis in the currently selected multi memory. The following display will appear.

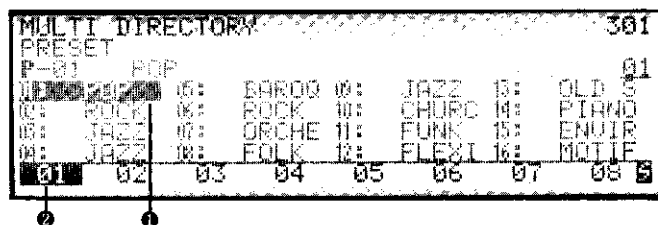

- ❶ The first seven characters of each twenty-character multi name will be displayed. When you select a different multi memory (internal, card, or preset) the sixteen multis in the newly

selected memory will be displayed. In addition to the usual methods of selecting a multi, you can also use the arrow keys to select a multi. When the multi directory is displayed, pressing a memory select button will immediately select a multi.

- ❷ Pressing F1–F8 (01)–(08) will select a multi 1–8 from the displayed multi directory. Holding SHIFT and pressing F1–F8 (09)–(16) will select a multi 9–16.

To return to the multi play display with the name of the selected multi displayed in large characters press EXIT.

## Copy multi

**Summary:** Anytime in multi play mode you can copy the currently selected multi to another multi memory.

**Procedure:**

From: multi play mode (JUMP #300, #301)

Press: COPY

Specify: the destination to which the multi will be copied.

To execute: the copy operation press F8 (Go).

To quit: without executing press EXIT.

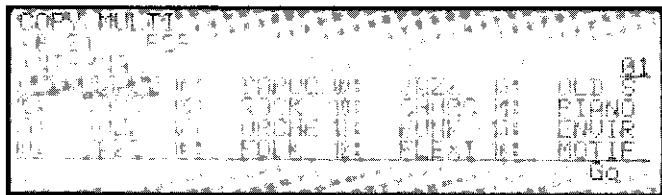

The names of the sixteen multis in Internal or Card memory are displayed as explained in *Multi Directory*. Press INTERNAL or CARD, and press a memory select button 1–16 to specify the copy destination.

After specifying the copy destination press F8 (Go). You will be asked “Are you sure?” If you are sure you want to copy the multi, press YES and the data will be copied. To quit without copying press NO.

**Note:** If you copy a multi from internal memory to card memory, all internal voice numbers used by that multi will be converted into card voice numbers. In the same way, if you copy a multi from card memory to internal memory, all card voice numbers used by that multi will be converted into internal voice numbers.

## Send program change

**Summary:** While in multi play mode you can transmit a program change message from MIDI OUT without affecting the SY77’s own tone generator. This allows you to switch a tone generator module connected to the SY77 MIDI OUT to another program without changing the SY77’s own program. An identical function is available in voice play mode.

**Procedure:**

From: multi play mode (JUMP #300)

Select: F1 (Send)

Specify: a program change number 1–128

To transmit: the program change press ENTER.

To quit: without sending a program change press EXIT

Use the numeric key pad to enter a one two or three digit number 1–128. Press ENTER and a program change message of the specified number will be transmitted on the *Kbd Trans Ch* (keyboard transmit channel) specified in *MIDI Utility job 1. Channel set* (JUMP #807).

If you enter a number below 1 it will be transmitted as 1. If you enter a number above 128 it will be transmitted as 128.

In addition to the program change transmitted by this function, a program change message will be transmitted each time you select a voice or multi unless the Utility mode setting *MIDI Utility 2. Program change* is turned off.

# MULTI EDIT MODE

This section explains the details of all Multi Edit parameters.

## MULTI EDIT MODE

From multi play mode press **EDIT** to enter multi edit mode. Unlike voice edit mode, multi edit mode has only a single job directory.

You can use the **SEQUENCER** control keys to playback sequencer song or sequencer pattern data while editing a multi. It is especially helpful to play a sequencer song back while editing a multi, since you will be able to hear the effect your modifications are having on each of the voices. For example you can edit multi parameters to modify the “mix”, or even edit a voice, all while the song is playing.



## Compare

When you are in edit mode but have not yet modified the data, a small square ■ is displayed at the left of the multi number to indicate that the voice has not yet been edited. If the data is edited in any way, this will change to an inverse "E".

If you want to see and hear the original data press EDIT (COMPARE) and the inverse "E" will change to a "C" indicating that you are in compare mode.

*Note: While comparing, EXIT, mode select, page, cursor, JUMP, COPY, and some of F1-F8 will not function.*

## Store multi

When you press EXIT or use the JUMP button to exit Multi Edit mode after editing the data, the top line of the display will ask "AUTO-STORE MULTI?"

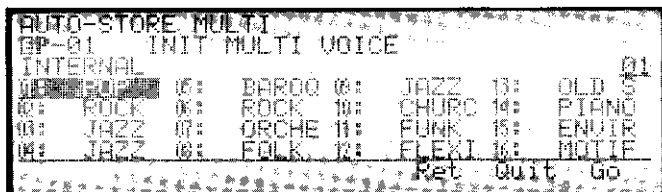

The LCD will show the first seven characters of the multi names in the currently selected internal or card multi memory. The multi name displayed in inverse indicates the multi memory into which the edited data will be stored.

1. Use INTERNAL or CARD to specify the multi memory, and select the multi memory 1–16 in which you want to store your newly edited multi.
2. Press F8 (Go), and the bottom line will ask "Are you sure !" (Yes or No)".
3. If you are sure you want to store the edited multi, press +1/YES and the bottom line of the LCD will show "Store completed". If you decide not to store, press -1/NO and the bottom line of the LCD will show "Store cancelled".
4. You will then return to multi play mode or the jump destination.

## Multi edit job directory

JUMP #400

**Summary:** The parameters of Multi Edit mode are divided into the jobs shown in this job directory.

**Procedure:**

- From: multi play mode (JUMP #300)
- Select: EDIT (JUMP #400)
- Specify: the desired multi edit job and press ENTER.

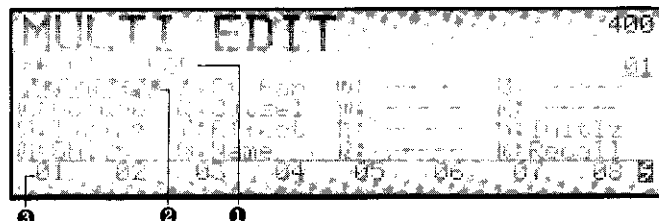

- 1 This area shows the number and name of the selected multi.
- 2 Move the cursor in this area to select a job and press ENTER to go to the selected job.

## MULTI EDIT MODE

- ③ Pressing F1–F8 will select the corresponding job 1–8. Holding SHIFT and pressing F7 or F8 will select job 15 or 16.
- 01: Voice (Voice Select): A multi consist of sixteen voices which are controlled by MIDI channels 1–16. A different voice can be selected for each of the sixteen channels in the multi.
- 02: Volume (Voice Volume): The volume of the voice played by each channel of the multi can be adjusted.
- 03: Tuning (Voice Tuning): The fine tuning of the voice played by each channel of the multi can be adjusted in steps of 1.1718875 cents.
- 04: Shift (Voice Note Shift): The pitch of the voice played by each channel of the multi can be adjusted in half steps.
- 05: St-Pan (Voice Static Pan): A fixed stereo position can be specified for the voice played

- by each channel of the multi, or a voice can use its own pan settings.
- 06: OutSel (Voice Output Select): All voices played by the multi are sent from output groups 1 and/or 2 to the effect unit. The selected output group determines how the voice will be processed through the effect unit.
- 07: Effect (Effect Set): The four effects in the effect unit can be arranged in various ways to add modulation and reverb to the sound.
- 08: Name (Name Multi): The multi being edited can be given a twenty-character name. In multi play mode this name will be displayed in large characters.
- 15: Initlz (Initialize Multi): The multi data being edited can be initialized to a set of standard values.
- 16: Recall (Recall Multi): The previously edited Multi data can be recalled for additional editing.

## 1. Voice select

JUMP #401

**Summary:** A multi consists of sixteen voices which are controlled by MIDI channels 1–16. A different voice can be selected for each of the sixteen channels in the multi.

### Procedure:

- From: multi job directory (JUMP #400)
- Select: job 01:Voice (JUMP #401)
- Specify: the voice for each channel of the multi

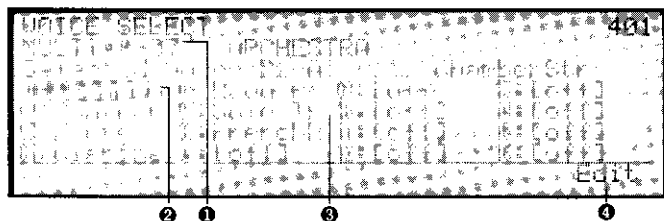

- ① This displays the number and name of the multi you are editing.
- ② This displays the number and name of the voice where the cursor is located.
- ③ Move the cursor in this area and select a voice for each of the sixteen channels in the multi. This area displays only the first seven characters of the selected voice name, but the voice number and name are fully displayed in ②. Each channel of the multi can use any voice from internal, card,

or preset memories, or can be set to an “off” voice. See *Off Voice* below for details.

A multi in card memory can use only card or preset voices. A multi in internal memory can use only internal or preset voices.

If a selected voice contains an AWM element which uses card waveform data, and if the correct card is not inserted into the WAVEFORM slot, a X mark will be displayed instead of the number 1–16, and that voice will not sound. (Each AWM waveform card has a unique ID number which is stored as part of the data for an AWM element.)

- ④ To edit the voice selected by the cursor, press F8 (Edit). You will enter voice edit mode. Details are the same as explained in *Voice edit mode*, but when you press EXIT to exit voice edit mode you will return to this *Multi edit 1. Voice select* job. However you will not be able to edit effect settings of the voice, and depending on the Voice static Pan setting of the multi, modifying the output select settings or dynamic pan settings of the voice may have no effect.

Since the SY77's sequencer can be used at any time even while editing a voice or multi, you can use this function to edit one of the voices in a multi *while that multi is being played from the sequencer*. This capability is very useful, since it allows you to edit a voice while it is being played in a musical context with other instruments.

**Off Voice:** Each channel of the multi can use any voice from internal, card, or preset memories, or can be turned "off". When turned off, the multi will not play a voice in response to data on that channel.

This allows you to play an external MIDI tone generator from certain channels of the SY77's built-in sequencer without sounding the SY77's own tone generator for those channels.

If you set the output level of an unwanted channel of the multi to 0 (see *Multi edit 2. Voice volume*) it will not be heard, but will still use the

SY77's tone generator whenever notes on that MIDI channel are received, and will therefore reduce the simultaneous notes available for the other voices. This is why you should turn unneeded channels of the multi "off".

To turn a channel off, hold the SHIFT button and press a memory select button 1–16. To restore the previous voice selection for that channel, hold SHIFT and press the corresponding memory select button 1–16 once again.

**Remarks:** In multi play mode the SY77 keyboard will normally play only the channel of the multi which matches the Keyboard MIDI Transmit Channel setting made in *MIDI utility 1. Channel set*. However in multi edit mode, the SY77 keyboard will play the voice where the cursor is located in this Voice Select job. This will remain in effect as long as you are in multi edit mode.

## 2. Voice volume

JUMP #402

**Summary:** Set the volume of the voice played by each channel of the multi.

**Procedure:**

From: multi job directory (JUMP #400)

Select: job 02:Volume

Specify: the volume for each channel

for channels 1–8 press (JUMP #402)

F1 (1–8)

for channels 9–16 press (JUMP #403)

F2 (9–16)

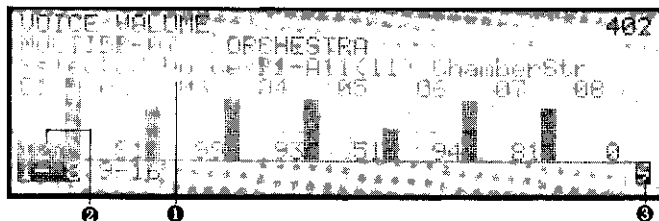

- ❶ Selected Voice: This displays the number and name of the voice played by the multi channel where the cursor is located.
- ❷ Voice Volume (0...127): Set the volume for each voice played by the sixteen channels of the multi. The volume for each voice is displayed as a vertical bar graph.
- ❸ Holding SHIFT and pressing F1–F8 will move the cursor to voices 1–8 or to voices 9–16, depending on whether F1 or F2 has been pressed.

## 3. Voice tuning

JUMP #404

**Summary:** Adjust the fine tuning of the voice played by each channel of the multi.

**Procedure:**

From: multi job directory (JUMP #400)

Select: job 03:Tuning

Specify: the tuning for each channel

for channels 1–8 press (JUMP #404)

F1 (1–8)

for channels 9–16 press (JUMP #405)

F2 (9–16)

## MULTI EDIT MODE

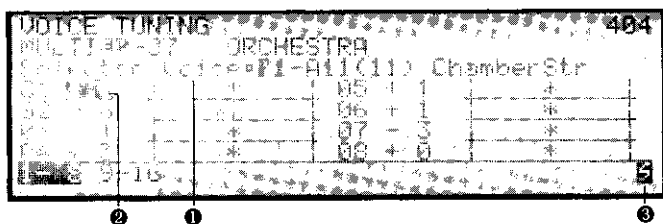

- 1 Selected Voice: This displays the number and name of the voice played by the multi channel where the cursor is located.
- 2 Voice Tuning (-63...+63 in steps of 1.1718875 cents): Set the tuning for each voice played by the sixteen channels of the multi. The tuning for each voice is displayed as a horizontal bar graph.

- 3 Holding SHIFT and pressing F1-F8 will move the cursor to voices 1-8 or to voices 9-16, depending on whether F1 or F2 has been pressed.

*Note: The actual pitch at which a voice will sound is affected by many other factors; System utility settings 1. Master tuning, Voice common data 2. Element detune, 3. Element note shift, 11. Micro tuning, AFM element data 2. AFM oscillator, 7. AFM pitch EG, and AWM element data 1. AWM waveform set, 6. AWM pitch EG.*

## 4. Voice note shift

JUMP #406

**Summary:** Adjust the note shift (transposition) of the voice played by each channel of the multi.

**Procedure:**

- From: multi job directory (JUMP #400)  
Select: job 04:Shift  
Specify: the note shift for each channel  
for channels 1-8 press (JUMP #406)  
F1 (1-8)  
for channels 9-16 press (JUMP #407)  
F2 (9-16)

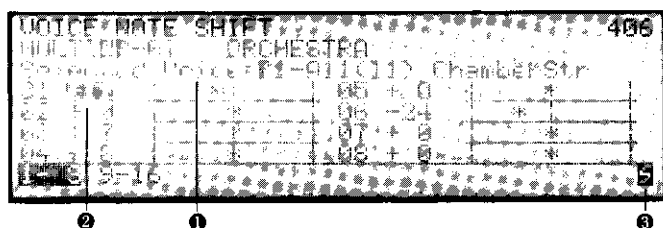

- 1 Selected Voice: This displays the number and name of the voice played by the multi channel where the cursor is located.
- 2 Voice Note Shift (-64...+63 in half steps): Set the note shift (transposition) for each voice played by the sixteen channels of the multi. The note shift setting for each voice is displayed as a horizontal bar graph.
- 3 Holding SHIFT and pressing F1-F8 will move the cursor to voices 1-8 or to voices 9-16, depending on whether F1 or F2 has been pressed.

*Note: This setting determines how note numbers received from the keyboard or MIDI IN are sounded, and has no effect on the data transmitted from MIDI OUT.*

## 5. Voice static pan

JUMP #408

**Summary:** Specify the stereo position for the voice played by each channel of the multi.

**Procedure:**

- From: multi job directory (JUMP #400)  
Select: job 05:St-Pan  
Specify: the static pan position for each channel  
for channels 1-8 press (JUMP #408)  
F1 (1-8)  
for channels 9-16 press (JUMP #409)  
F2 (9-16)

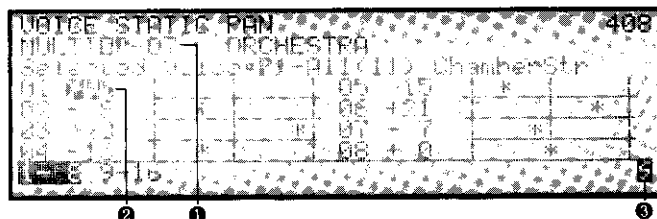

- 1 Selected Voice: This displays the number and name of the voice played by the multi channel where the cursor is located.

- ② Voice Static Pan (VC or -31...+31 = left...right): Set the static pan position for each voice played by the sixteen channels of the multi. The static pan setting for each voice is displayed as a horizontal bar graph.

It is also possible to select "VC", when the voice will use its own pan data. If "VC" is not selected, the pan data of the voice will be

ignored and the static pan setting you specify here will be used. If "VC" is not selected for a drum voice, all the drum sounds will be panned to the same pan position -31...+31 you specify here.

- ③ Holding SHIFT and pressing F1-F8 will move the cursor to voices 1-8 or to voices 9-16, depending on whether F1 or F2 has been pressed.

## 6. Voice output group select

JUMP #410

**Summary:** Each voice can be sent from either or both output groups, to determine how the voice will be processed through the effect units.

**Procedure:**

- From: multi job directory (JUMP #400)
- Select: job 06:OutSel
- Specify: the output group for each channel
  - for channels 1-8 press (JUMP #410) F1 (1-8)
  - for channels 9-16 press (JUMP #411) F2 (9-16)

Multi edit settings cannot determine the output group for a multi channel that plays a drum voice, and the cursor cannot be moved to these voices. The display will show "Output = drum", and the drum voice data will determine which output group is used by each drum sound. Refer to *Drum set data, 2. Wave data set* (JUMP #274).

- ③ Holding SHIFT and pressing F1-F8 will move the cursor to voices 1-8 or to voices 9-16, depending on whether F1 or F2 has been pressed.

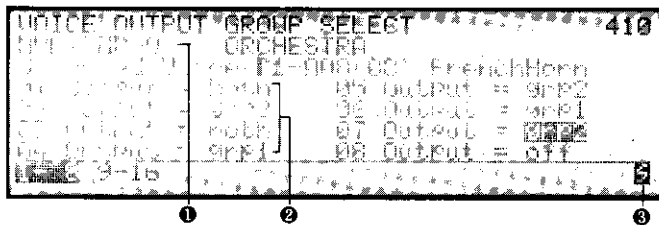

- ① Selected Voice: This displays the number and name of the voice played by the multi channel where the cursor is located.
- ② Output (off, grp1, grp2, both): Each voice played by a multi is independently panned according to the setting of 5. *Voice static pan*, and this stereo output of each voice is sent to the DSP effects unit via Output Group 1 or 2. The output group setting of the voice itself will be ignored unless this is set "off".

**Output:** The selected Output Group(s) will determine how the voice is sent to the two output groups. If the output group is "off", the voice will not be sent to the output groups, and will not be heard. If the output group is 1, 2, or "Both", the voice will be sent to the corresponding output groups. From the output groups, the sound will be sent through the effect units as specified by the Effect Mode setting in 7. *Effect set*.

Channel	Voice	Static Pan	Output Select	Group 1	Group 2	Four DSP effect units
1	P1 - C03 BigBand	-15	both	L	R	Four DSP effect units
2	P1 - D10 Thumb Bass	VOICE	1			
3	P1 - A01 Grand Piano	+31	2			
...	...	...	...			
16	P1 - C15 Clarinet	+04	2	L	R	

## 7. Effect set

JUMP #412

**Summary:** The four effects in the effect unit can be arranged in various ways to add modulation and reverb to the sound.

**Procedure:**

- From: multi job directory (JUMP #400)
- Select: job 07:Effect (JUMP #412)

## MULTI EDIT MODE

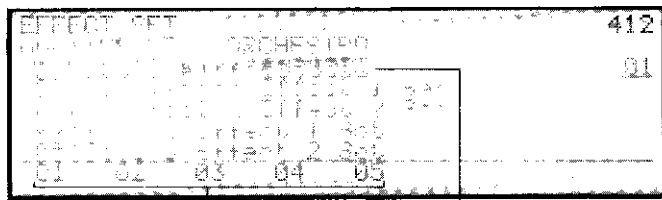

- ① Move the cursor in this area to select a job.
  - 01: Effect Mode Select: Specify how the four effect units will be connected. (JUMP #413)
  - 02: Modulation Effect 1 Set: Select an effect type and set parameters for modulation effect 1. (JUMP #414, #415)
  - 03: Modulation Effect 2 Set: Select an effect type and set parameters for modulation effect 2. (JUMP #416, #417)
  - 04: Reverb Effect 1 Set: Select an effect type and set parameters for reverb effect 1. (JUMP #418, #419)

05: Reverb Effect 2 Set: Select an effect type and set parameters for reverb effect 2. (JUMP #420, #421)

- ② Pressing F1–F5 will select the corresponding job.

The sixteen voices played by a multi are processed through the effect units as determined by the output group selected for each voice. Refer to the previous section, 6. *Voice output group select.*

Job 1.Effect Mode Select determines how the two input groups are routed through the four effect units, and jobs 2–5 determine how each effect unit will process the sound.

Effect settings in multi mode are exactly the same as explained in voice mode. For details, refer to *Voice common data 10.1–10.5.*

## 8. Multi name

JUMP #422

**Summary:** The multi being edited can be given a twenty-character name. In multi play mode, this multi name will be displayed in large characters.

**Procedure:**

- From: multi job directory (JUMP #400)  
Select: job 08:Name (JUMP #422)  
Specify: the name for the multi



- ① Enter a twenty-character name for the multi.
- ② To clear the currently entered name press F1 (Clr). To switch to upper-case characters press F2 (Uppr). To switch to lower case characters press F3 (Lowr).

**Remarks:** Methods of entering character data are explained in *Introducing the SY77, How to use the numeric key pad*, on page 30.

## 15. Initialize multi

**Summary:** The multi data being edited can be initialized to a set of standard values.

**Procedure:**

- From: multi job directory (JUMP #400)  
Select: job 15:Initzl  
To execute: the initialize operation press YES.  
To quit: without executing press NO or EXIT.

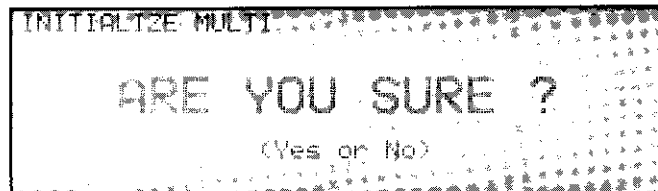

This function sets all multi data values to the minimum or simplest possible setting. When you are creating a new multi it is often convenient to start with the initial settings.

If you are sure you want to initialize the multi data, press YES and the data of the multi being edited will be set to the values shown below. If you decide not to initialize, press NO.

### Initialized settings for Multi data

- 01 Voice select  
Preset 1 A01(01) GrandPiano (all channels)
- 02 Voice volume  
Volume = 127 (maximum) (all channels)

- 03 Voice tuning  
Tuning =  $\pm 0$  (all channels)
- 04 Voice note shift  
Note Shift =  $\pm 0$  (all channels)
- 05 Voice static pan  
Pan =  $\pm 0$  (= center) (all channels)
- 06 Voice output group select  
Output = both (all channels)
- 07 Effect set  
\*\*\* same as for normal voice \*\*\*
- 08 Name multi  
Name = INIT MULTI VOICE

## 16. Recall multi

**Summary:** The previously edited Multi data can be recalled for additional editing.

**Procedure:**

From: multi job directory (JUMP #400)

Select: job 16:Recall

To execute: the recall operation press YES.

To quit: without executing press NO or EXIT.

If after editing a multi you exit multi edit mode without storing, the edited multi data will be lost. In such cases, you can use this function to recall the previously edited multi data into the editing buffer.

If you are sure you want to recall, press YES and the previously edited multi data will be recalled into the editing buffer. If you decide not to recall, press NO.

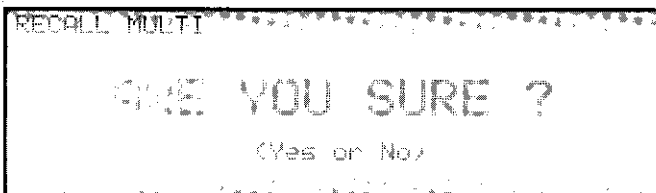





# SONG MODE

Song mode allows you to record up to 15 tracks, with each track containing an independent musical part. These tracks can be edited in different ways, and the musical data of each track can be transmitted on its own MIDI channel to play a different voice in a Multi or an external synthesizer.

<b>Contents of this section</b>	<b>page</b>
<b>Song play .....</b>	<b>172</b>
<b>Song record .....</b>	<b>174</b>
<b>Song edit.....</b>	<b>179</b>
<b>Song edit jobs .....</b>	<b>185</b>
<b>Song setup jobs .....</b>	<b>196</b>
<b>Song name.....</b>	<b>199</b>

## SONG MODE

In song mode you can play back and record Tracks. Each track contains an independent musical part. The SY77's sequencer has 16 tracks and each track extends the entire length of the song.

As shown in the following diagram, *Song Setup job 2. Output Channel* allows you to specify the channel on which each sequencer track will transmit its data. All data from the sequencer will be sent to the Multi as well as transmitted from the SY77's MIDI OUT, allowing you to play other synthesizers or tone generators from the SY77's sequencer.

A Multi consists of a voice selection and other settings for each of the 16 channels. If you want to use a sequencer track only to play an external tone generator via MIDI OUT, you must select an "off" voice for the corresponding channel of the multi.

In the diagram above, sequencer track 2 is transmitting on channel 3. Channel 3 of the multi is set to the "off" voice, so sequencer track 2 will not play the multi. The sequence data will be transmitted from MIDI OUT, however, and can be played by an external tone generator set to the appropriate channel.

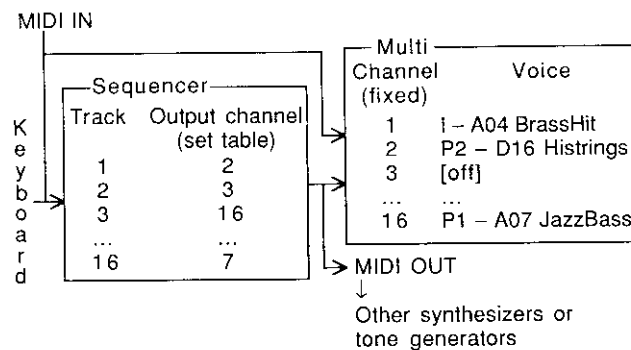

**Note:** The SY77 sequencer will also record MIDI data received from MIDI IN, in addition to the data from its own keyboard and controllers. However, system exclusive messages longer than 32 bytes cannot be recorded.

### **Important note for when recording**

The "used" display indicates the amount of used sequencer memory.

Whenever you start recording, the SY77 sequencer reserves part of the remaining unrecorded sequence memory as processing area. Thus, it is not possible to record the entire memory of the sequencer in a single pass.

For example if you begin recording a new track, you will be able to continuously record for approximately half of the remaining memory. If you begin recording on an already existing track, somewhat less memory can be recorded on a single pass. In this way, you can record up to 99% of the sequencer memory, but in successively smaller portions.

If you attempt to continuously record beyond this limit, all data recorded in that pass will be lost.

# How song play mode and song edit mode are organized

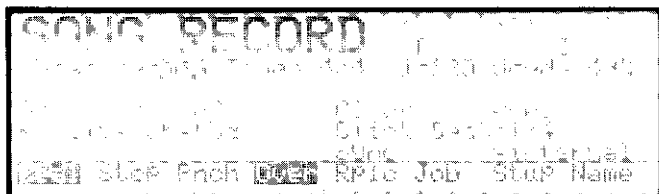
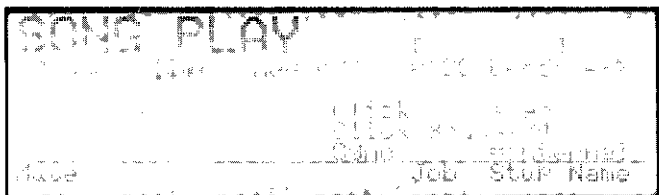
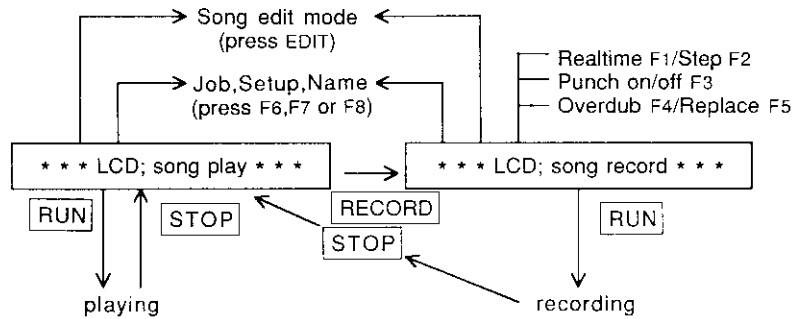

From the Song Play display you can press F6 to enter the Song Edit Job job directory, F7 to enter the Song Setup job directory, or F8 to set the song name.



- 01:Quantz Quantize
- 02:MdfGat Modify gate time
- 03:MdfVel Modify velocity
- 04:Cresc Crescendo
- 05:Transp Transpose
- 06:ThinOt Thin out
- 07:ErEvt Erase event
- 08:NtShft Note shift

- 09:MvClok Move clock
- 10:CpMeas Copy measure
- 11:ErMeas Erase measure
- 12:DelMeas Delete measure
- 13:CrMeas Create measure
- 14:MixTrk Mix track
- 15:ErsTrck Erase track
- 16:ClrSong Clear song

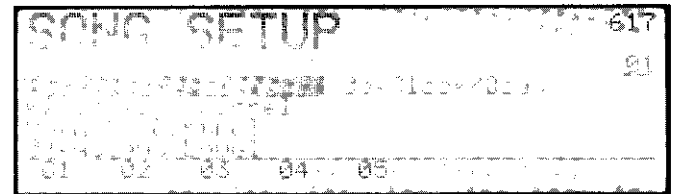

- 01: Receive Event
- 02: Output Channel
- 03: MIDI Control
- 04: Accent Level
- 05: Clock/Beat

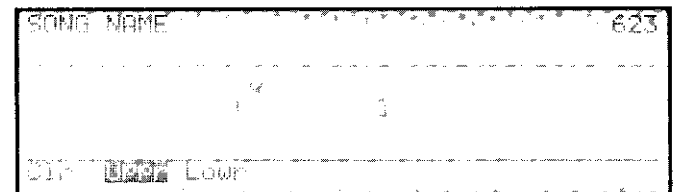

## Song play

**Summary:** This is where you will playback the song.

You can also make settings for the metronome and synchronization.

**Procedure:**

From: any mode

Press: SONG to enter song play mode. The SONG LED will light red.

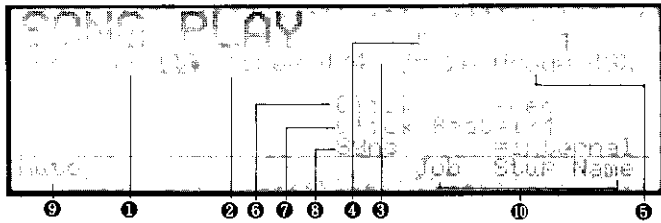

- ① Measure (001...999): This determines the measure from which the song will begin playback. You can modify this by moving the cursor here and specify the measure, or by using the sequencer location buttons (◀, ◀◀, LOCATE, or ▶▶).
- ② Time (1/4...32/16): This displays the time signature you specified in song record mode. This cannot be modified in song play mode.
- ③ (30...250): This determines the tempo in quarter notes per minute.
- ④ This area displays the song name you assigned in *Song name* (JUMP #623).
- ⑤ Used (0...100%): This displays the amount of used sequencer memory.
- ⑥ Click (off, rec, rec/play, always): This determines when the click (metronome) will sound.
  - off: The metronome will not sound.
  - rec: The metronome will sound only during recording.
  - rec/play: The metronome will sound during recording or playback.
  - always: The metronome will sound constantly.
- ⑦ Click Beat (1/4, 1/6, 1/8, 1/12, 1/16, 1/24): This determines the beat on which the click will sound.
- ⑧ Sync (internal, MIDI): This determines the timing source which will control the sequencer. Normally you will leave this set to internal so that the SY77's own clock will determine the tempo.

If you are using an external MIDI sequencer and want the SY77's sequencer to play in synchronization with it, set this to MIDI so that MIDI clock messages received at MIDI IN will determine the tempo.

- ⑨ Pressing F1 (Mute) will mute all tracks so that you will hear no sound even during playback. Notes which are already sounding when you press F1 will continue sounding for their original duration. Press F1 once again to un-mute the tracks.
- ⑩ To move to the Song Edit Job job directory press F6 (Job). To move to the Song Setup job directory press F7 (Stup). To set the song name press F8 (Name).

**Select tracks for playback:** Use the sixteen memory select buttons to select the tracks for playback. Each track LED will light green to indicate a track which contains data. Pressing a button will alternately turn the track on (the LED is lit) or muted (the LED is blinking). You can also press F1 (Mute) to mute all the tracks.

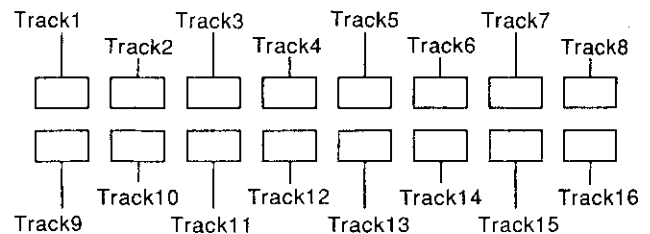



**Start and stop playback:** Press RUN and the song will begin playback from the point specified by the measure setting. To stop playback press STOP.

**During playback:** During playback you can move the cursor and modify tempo, click, and click beat settings.

**Locate:** Any time while in song play mode (even during playback), you can hold SHIFT and press LOCATE to mark the current measure. While the sequencer is stopped, you can press LOCATE to instantly move to this measure.

In addition to LOCATE, the following keys can be used while the sequencer is stopped to move backwards and forwards in the song.

-  Move to the beginning of the song
-  Move backward one measure (continue pressing to move rapidly)
- LOCATE Move to a previously set location
-  Move forward one measure (continue pressing to move rapidly)

**Song edit:** Any time in song play mode while the sequencer is not playing back, you can press EDIT to edit the song. For details refer to *Song Edit Mode*.

**Simultaneous note capacity:** The SY77 sequencer can playback up to 32 notes at once. During playback, any new notes which would exceed this number will be ignored.

**Timing priority:** Since track 16 (the pattern track) will often be used to play rhythm parts, highest priority is given to playing it on time. Timing priority is then given to tracks 1, 2, ... 15.

## Song record

**Summary:** This is where you make settings in preparation for recording a song. You can specify the mode and type of recording, set the time signature, and make other settings as in the Song Play display.

**Procedure:**

From: song play display press RECORD. The RECORD LED will light.

Specify: the recording mode and make recording settings.

To start: recording press RUN.

To stop: recording press STOP.

The song record display will differ according to whether or not punch-in recording has been selected.

If Realtime or Step recording has been selected

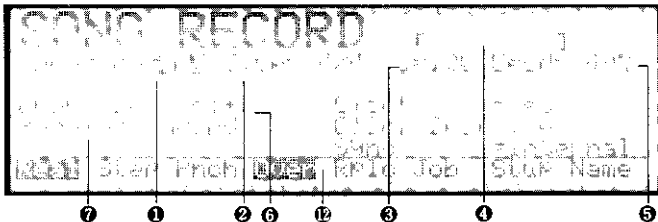

If Punch-in recording has been selected

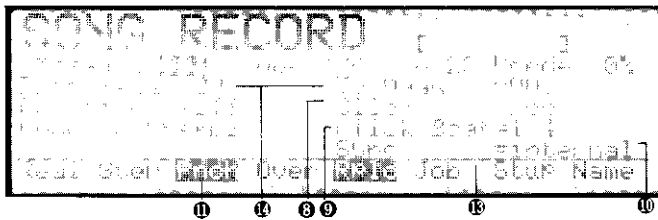

- ① Measure (001...999): This determines the measure from which the song will begin playback. You can modify this by moving the cursor here and specifying the measure, or by using the sequencer location buttons (◀, ◀◀, LOCATE, or ▶▶).
- ② Time (01-08/4, 01-16/08, 01-32/16): This determines the time signature of measures that will be recorded. (A song may contain measures of differing time signatures.)
- ③ (30...250): This determines the tempo in quarter notes per minute.

- ④ This area displays the song name you assigned (refer to *Song Name*).
- ⑤ Used (0...100%): This displays the amount of sequencer memory already used. Since recording and editing operations require some memory for processing, it may not always be possible to continue recording until this displays 100%.
- ⑥ Quantize (off, 1/32, 1/24, 1/16, 1/12, 1/8, 1/4, 1/2): This determines the timing accuracy to which the notes you play will be corrected. When quantization is turned off the notes you play will be recorded at the exact timing they occur. When a quantization of 1/32...1/2 is selected, all notes you play will be moved to the nearest timing at the specified interval.
- ⑦ Receive Channel (1-16, omni, kbd): This determines the channel that will be recorded by the sequencer.

1-16: The sequencer will record only the data received on the specified channel from MIDI IN.

omni: The sequencer will record all data of any channel from MIDI IN.

kbd: The sequencer will record the notes played on the SY77 keyboard, regardless of the Kbd Transmit channel setting.

- ⑧ Click (off, rec, rec/play, always): This determines when the click (metronome) will sound.
  - off: The metronome will not sound.
  - rec: The metronome will sound only during recording.
  - rec/play: The metronome will sound during recording or playback.
  - always: The metronome will sound constantly.
- ⑨ Click Beat (1/4, 1/6, 1/8, 1/12, 1/16, 1/24): This determines the beat on which the click will sound.
- ⑩ Sync (internal, MIDI): This determines the timing source which will control the sequencer. Normally you will leave this set to internal so that the SY77's own clock will determine the tempo.

If you are using an external MIDI sequencer and want the SY77's sequencer to play in synchronization with it, set this to MIDI so that MIDI clock messages received at MIDI IN will determine the tempo.

**11** Recording mode (Real, Step, Pnch): Press F1, F2 or F3 to select the recording mode.

Realtime recording (press F1): Notes will be recorded at the exact time you play them.

Step recording (press F2): Notes will be recorded one by one with the specified time value, regardless of the actual timing with which you play.

Punch-in recording (press F3): The same as realtime recording except that recording will take place only over the measures specified by **14** From Meas and To Meas.

**12** Overdub/Replace (Over, Rplc): This determines how newly recorded data will be added to the track.

Overdub recording: If you select overdub recording by pressing F3, notes you record will added to the data already in the track. The track will then contain both the old and new data. If step recording has been selected in **11**, overdub recording will automatically be selected. In punch record mode, overdub recording can not be selected.

Replace recording: If you select replace recording by pressing F4, notes you record will replace the data previously in the track. The track will contain only the new data, and the old data will be lost. If step recording has been selected in **11**, replace recording cannot be selected.

**13** Press F6–F8 to move to the Song Edit Job job directory, the Song Setup job directory, or to set the song name.

**14** From Meas (001...999), To Meas (001...999): If F3 (Pnch) has been pressed to select punch-in recording, you will be able to specify the range of measures over which recording will take place.

**Recording procedure:**

1. If necessary, specify the measure at which recording will begin, and modify the settings for time, tempo, quantize, receive channel, click, click beat, and sync.
2. Specify the recording mode; realtime (F1), step (F2), or punch-in (F3).
3. If you specified punch-in recording in step 2, set the beginning (From Meas) and end (To Meas) of the recorded area.
4. Specify overdub (F3) or replace (F4).
5. Press a memory select button 1–16 to select the track on which to record. The LED of the selected track will light red. The LEDs of tracks which already contain data are lit green.
6. Press RUN and recording will begin. The recording display will depend on the recording mode selected in step 2. For details see the following sections; *Realtime Recording*, *Punch-in Recording*, and *Step Recording*.
7. When you are finished recording press STOP and you will return to the song play display.

**Song edit:** Any time while in song record mode (except while recording) you can press EDIT to edit the song. For details refer to *Song Edit Mode*.

SONG RECORD **Realtime recording**

**Summary:** In realtime recording the notes you play will be recorded in the exact timing with which you play them

**Procedure:**

From: song record display

Press: F1 (Real) to select realtime recording

To begin: recording press RUN. The RUN LED will blink to the tempo.

To stop: recording and return to the song play display press STOP.

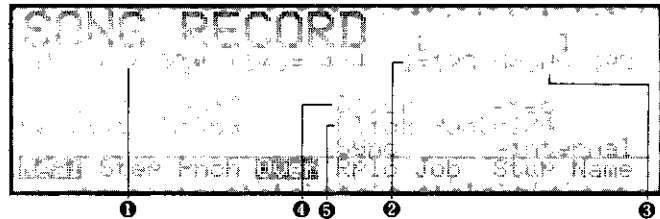

**1** Measure (001...999): As you record this will advance to show the number of the measure currently being recorded.

## SONG MODE

- ②  (30...250): While recording you can move the cursor here to modify the tempo.
- ③ Used (0...100%): As you record this will increase to show the amount of sequencer memory that has been used.
- ④ Click (off, rec, rec/play, always): While recording you can move the cursor here and specify when the click (metronome) will sound.
  - off: The metronome will not sound.
  - rec: The metronome will sound only during recording.
  - rec/play: The metronome will sound during recording or playback.
  - always: The metronome will sound constantly.

- ⑤ Click Beat (1/4, 1/6, 1/8, 1/12, 1/16, 1/24): While recording you can move the cursor here and specify the beat on which the click will sound. While recording or playing back, the RUN LED will blink green on each beat and blink red on the first beat of each measure.

**Remarks:** While recording you can modify the settings for tempo, click, and click beat. To modify the other parameters you must return to the song record display.

## SONG RECORD

### Punch-in recording

**Summary:** In punch-in recording the notes you play will be recorded in the exact timing with which you play them, but only over the measures you specify.

#### Procedure:

From: song record display

Press: F3 (Pnch) to select punch-in recording

Specify: the measures over which recording will take place.

To begin: recording select the track to be recorded and press RUN. The RUN LED will blink to the tempo.

To stop: recording and return to the song play display press STOP.

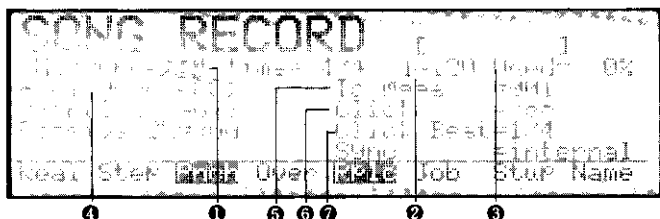

- ① Measure (001...999): As you record this will advance to show the number of the measure currently being recorded.
- ②  (30...250): While recording you can move the cursor here to modify the tempo.
- ③ Used (0...100%): As you record this will increase to show the amount of sequencer memory that has been used.
- ④ From Measure (001...999): When the beginning of this measure is reached, recording will begin.

The notes you play will replace the previous data in the track.

- ⑤ To Measure (001...999): When the end of this measure is reached recording will end, but the song will continue playing back.
- ⑥ Click (off, rec, rec/play, always): While recording you can move the cursor here and specify when the click (metronome) will sound.
  - off: The metronome will not sound.
  - rec: The metronome will sound only during recording.
  - rec/play: The metronome will sound during recording or playback.
  - always: The metronome will sound constantly.
- ⑦ Click Beat (1/4, 1/6, 1/8, 1/12, 1/16, 1/24): While recording you can move the cursor here and specify the beat on which the click will sound.

**Remarks:** While recording you can modify the settings for tempo, click, and click beat. To modify the other parameters you must return to the song record display.

It is a good idea to set the location to a few measures before the punch-in point specified by From Measure. This will give you a chance to get the feel of the section you are going to re-record.

When the punch-out point specified by To Measure is reached, recording will end and the RECORD LED will go out, but playback will continue.



## Step recording

**Summary:** In song step record mode, notes will be recorded one by one with the specified time value, regardless of the actual timing at which you play. This makes it possible to input very complex passages which would be difficult to play in realtime.

### Procedure:

From: song record display

Press: F2 (Step) to select step recording.

To begin: recording specify the track to be recorded and press RUN. The RUN LED will light green.

Record: data as explained in the *Recording Procedure* below.

To stop: recording and return to the song play display press STOP.

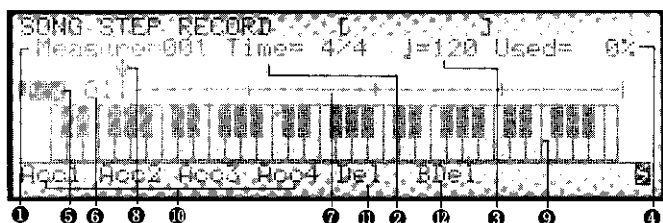

- ① Measure (001...999): To move to another measure, place the cursor here and modify the data.
- ② Time (01-08/4, 01-16/08, 01-32/16): The time signature is only displayed, and cannot be modified.
- ③ ♩: The tempo is only displayed, and has no effect in step recording.
- ④ Used (0...100%): This displays the amount of sequencer memory already used.
- ⑤ This area indicates the currently selected note value. At any time in step recording you can use the numeric keypad to enter note values. You can also move the cursor to this area and modify the note values. If possible, the note values in this area will be displayed as graphic symbols for a whole note, quarter note, etc. Otherwise the note value will displayed as a number of clocks (1/384th notes).
- ⑥ When the cursor is located in this area you can move backwards and forwards through the data in time. If the current measure is longer than four quarter notes (e.g., a time signature of 10/8), a

number will be displayed here to indicate the section of the measure now being displayed.

- ⑦ The measure bar represents one measure, and vertical divisions represent one beat. A dot will be displayed on the bar to indicate a 32nd note area which contains data.
- ⑧ As you move backward or forward through the data in time, an arrow pointing downward will move in 32nd note steps to indicate the current position in the measure.
- ⑨ If the currently selected 32nd note area contains data, the notes in that area will be displayed on the keyboard diagram.
- ⑩ To select an accent value, press F1-F4. Subsequently entered notes will be given the selected accent value. With the initial settings, Acc1=24, Acc2=56, Acc3=88, and Acc4=120. To change the accent value assigned to F1-F4 refer to *Song setup job 4. Accent level*.
- ⑪ To delete all data in the 32nd note area where the cursor is located, press F5 (Del). The cursor location will not change.
- ⑫ This function, F6 (BDel) depends on the current note length. If the currently selected note length is 1/4 then data at the location 1/4 note previous to the current position will be deleted. The cursor will move back 1/4 note.

**Note duration:** To specify how long the note will be held in relation to its note value hold SHIFT and press F1-F3. To record normal notes which sound for 80% of their note values press F1 (Norm). To record staccato notes which sound for 50% of their note values press F2 (Stac). To record slurred notes which sound for 99% of their note value press F3 (Slur).

### Numeric keypad:

- Note value (numeric keys 1-8): Use the numeric keys 1-8 to specify the note value to be recorded. Pressing each key will select the note value printed above it, from a whole note (key 1) to a 16th note triplet (key 8). This also determines the step time by which the cursor will automatically advance after each note has been entered.

## SONG MODE

- Dot (numeric key 9): To dot the current note value press numeric key 9. The current note value will be extended by 50%.
- Tie (numeric key “-”): To extend the duration of the previously entered note, press TIE. The duration of the note will be extended by the current note value, and the cursor will advance accordingly.
- Rest (numeric key 0): To advance one step without entering data press REST.
- Scroll through the data: When the cursor is located at **6** you can also use the cursor keys <> to move back and forth in the track and enter notes wherever you like. When you come to note data, it will be displayed on the keyboard diagram below and sounded on the synthesizer.
- To stop recording: When you are finished recording the song press STOP. You will return to the song play display, where you can press RUN and hear the song you just recorded.

### **Recording procedure:**

- Enter notes: Each time you press and release a key it will be recorded, and the position will move ahead one step as specified by the step time. The note will not be entered until all keys have been released. This allows you to enter more than one note at the same location by pressing more than one note before releasing the first.

## Song edit

**Summary:** In song edit mode you can edit individual events that have been recorded in tracks 1–15.

**Procedure:**

From: song mode when the SONG LED is lit red

Press: EDIT

Select: the track to edit

Edit: the data as explained in the following sections.

To exit: song edit mode and return to song play mode press EXIT.

The song edit display will differ according to whether graphic or data editing has been selected, and whether tracks 1–15 or track 16 has been selected.

If graphic editing has been selected (tracks 1–15)

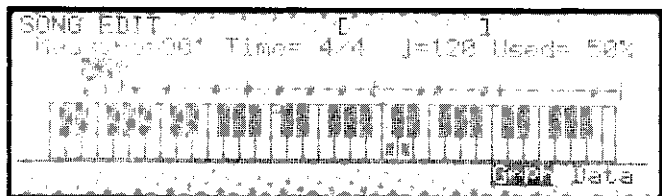

If data editing has been selected (tracks 1–15)

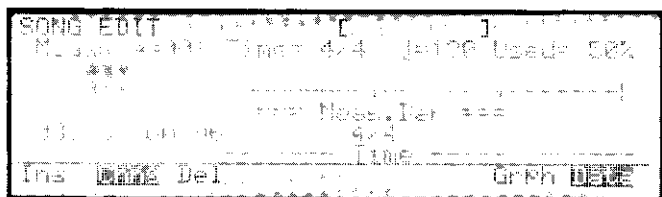

If track 16 has been selected for editing

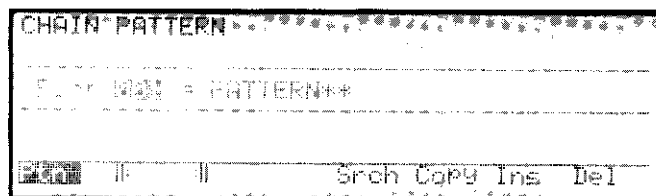

**Select the track to edit:** Press a memory select button 1–16 to select the track to edit. Tracks 1–15 contain sequence data and track 16 contains pattern data.

**Song graphic editing (tracks 1–15):** To select graphic editing when a track 1–15 is selected, press F7 (Grph). A horizontal line will be displayed with dots indicating the position of note data in the measure. A keyboard diagram below will indicate the notes at the currently selected 32nd note area. For details refer to the following section *Song edit (graphic mode)*.

**Song data editing (tracks 1–15):** To select data editing when a track 1–15 is selected, press F8 (Data). The display will show the type and numerical values for each event. Data editing is divided into two modes; insert and change. For details refer to the following sections *Song edit (data insert)* and *Song edit (data change)*.

**Chain pattern editing (track 16):** When track 16 is selected, the display will show the pattern number assigned to each part. For details refer to the following section *Chain pattern*.

SONG EDIT

## Song edit (graph)

**Summary:** In song editing graph mode, the notes in the selected track 1–15 will be graphically displayed on a keyboard diagram. Data can only be viewed, not edited in graph mode.

**Procedure:**

From: song mode when the SONG LED is lit red

Press: EDIT

Select: a track 1–15

Press: F7 (Grph).

View: the data as explained below.

To exit: song edit mode and return to song play mode press EXIT.

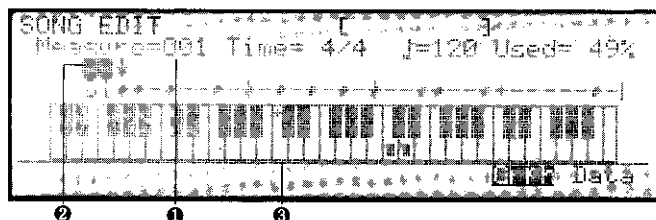

## SONG MODE

- 1 Measure (001...999): This indicates the measure that is displayed. You can move the cursor here and select another measure, or use the sequencer location keys  $\leftarrow$ ,  $\ll$ , LOCATE, or  $\gg$ .
- 2 You can use the dial,  $-1 +1$ , or the slider to move within the step area in 32nd note steps by placing the cursor here. As you come to note data, it will be displayed on the keyboard diagram below and sounded on the synthesizer.
- 3 If the currently selected 32nd note step contains note data, the notes will be displayed on this keyboard diagram.

## SONG EDIT

### Song edit (data change)

**Summary:** In song editing data change mode, all data in the selected track 1-15 will be displayed numerically. You can change the values of existing data, or delete the currently displayed data.

#### Procedure:

From: song mode when the SONG LED is lit red

Press: EDIT

Select: a track 1-15

Press: F8 (Data) and then press F2 (Chng).

Select: the data you wish to edit

Specify: the data parameters and location.

To change: the data press ENTER

To exit: song edit mode and return to song play mode press EXIT.

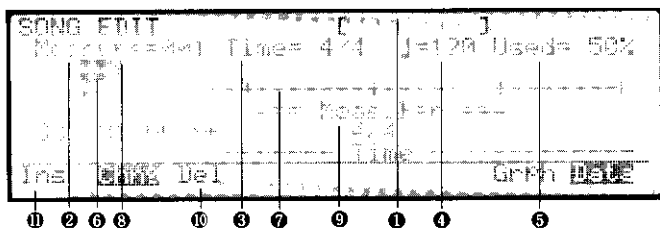

- 1 Song Name: This displays the name of the song.
- 2 Measure (001...999): To move to another measure in the track, place the cursor here and modify the data.
- 3 Time (01-08/4, 01-16/08, 01-32/16): This displays the time signature of the current measure in the track.
- 4  $\text{J}$ : Tempo is only displayed, and has no effect in song edit mode.
- 5 Used (0...100%): This displays the amount of sequencer memory already used.

**Select the track to view:** While in song edit graph mode you can press a memory select button 1-15 to select the track to view. If you select track 16 the display will be as explained in the following section, *Chain pattern*.

**Remarks:** Graph edit mode only displays the data in the track. To edit data you must use either data change mode or data insert mode.

- 6 When the cursor is located in this area you can use  $-1 +1$  or the dial to move backwards and forwards through the data in time. If the current measure is longer than four quarter notes (e.g., a time signature of 10/8), a number will be displayed here to indicate the section of the measure now being displayed.
- 7 The horizontal line represents one measure, and vertical divisions represent one beat. A dot will be displayed on the bar to indicate a 32nd note area which contains data.
- 8 As you move backward or forward through the data in time, an arrow pointing downward will move in 32nd note steps to indicate the current position in the measure.
- 9 This area numerically shows the data at the cursor location. Move the cursor to the data you wish to modify, modify the data, and press ENTER.
- 10 To delete the currently displayed data press F3 (Del).
- 11 To move to Insert mode press F1 (Ins).

**Move through the data:** As mentioned above, when the cursor is located at 6 you can use  $-1 +1$  or the dial to move backwards and forwards through the data. You can also move through the data *regardless* of the location of the cursor by holding SHIFT and using  $-1 +1$  or the dial.

**Change the location of the data:** In addition to the data values for each type of data, you can also modify the location (measure, beat, clock) to move the data in time.

**Change the data values:** The following section *Song edit (data insert)* explains the values which can be modified for each type of data. After modifying the data values and/or location, be sure to press ENTER if you wish to finalize the change.

**Top/end of Track:** To indicate the beginning or end of the track, the display will show "Top of Track" or "End of Track". This data cannot be changed.

SONG EDIT

## Song edit (data insert)

**Summary:** In song editing data insert mode, you can insert any type of data into any location in the selected track 1–15.

### Procedure:

From: song mode (when the SONG LED is lit red)

Press: EDIT

Select: a track 1–15

Press: F8 (Data) and then press F1 (Ins).

Specify: the type, parameters, and location of the data you wish to insert.

To insert: the data press ENTER.

To exit: song edit mode and return to song play mode press EXIT.

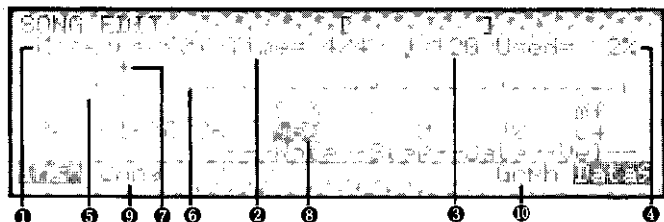

- ① Measure (001...999): To move to another measure in the track, place the cursor here and modify the data.
- ② Time (01–08/4, 01–16/08, 01–32/16): This displays the time signature of the measure in the track being edited.
- ③ Tempo is only displayed, and has no effect in step record mode.
- ④ Used (0...100%): This displays the amount of sequencer memory already used.
- ⑤ When the cursor is located in this area you can move backwards and forwards through the data in time. If the current measure is longer than four quarter notes (e.g., a time signature of 10/8), a number will be displayed here to indicate the section of the measure now being displayed.
- ⑥ The measure bar represents one measure, and vertical divisions represent one beat. A dot will be displayed on the bar to indicate a 32nd note area which contains data.

- ⑦ As you move backward or forward through the data in time, an arrow pointing downward will move in 32nd note steps to indicate the current position in the measure.
- ⑧ This area numerically shows the data that will be inserted at the cursor location. To specify the type of data to be inserted, hold SHIFT and press F1–F6 to enter one of the types of data explained below. Move the cursor and modify the parameters as desired, and press ENTER to insert the data at the current location.
- ⑨ To move to Change mode press F2 (Chng).
- ⑩ To move to Graph mode press F7 (Grph).

**Note:** The following display will appear, and you can move the cursor to specify the following data; location ("001-01-00/96", etc.), note number (Note 0...127), gate time (Gate 1...8188) in multiples of 4, and note-on velocity (Velocity 1...127).

Gate time is displayed as the number of clocks (1/96th of a beat) that the note will be held, but can be specified only in multiples of 4.

Step time (Step 0...9999) is displayed to indicate the time until the next event, but cannot be edited.

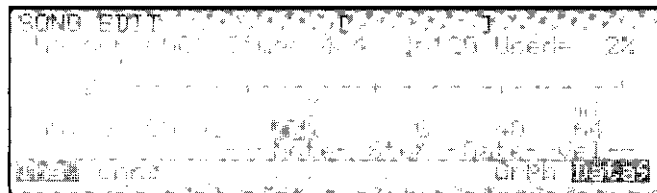

**Program change:** To enter program change data hold SHIFT and press F2 (Prog). The following display will appear, and you can move the cursor to specify the the program change number (Value 0...127). A program change of 0 will select the first program; A01 in the case of the SY77.

## SONG MODE

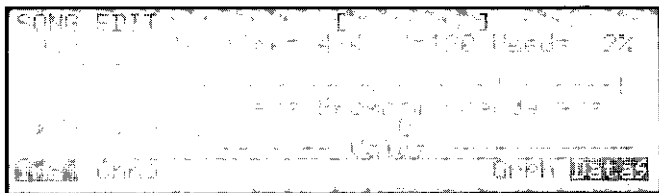

**Pitch bend:** To enter pitch bend data hold **SHIFT** and press **F3 (PB)**. The following display will appear, and you can move the cursor to specify the pitch bend data (Value -8192...8191).

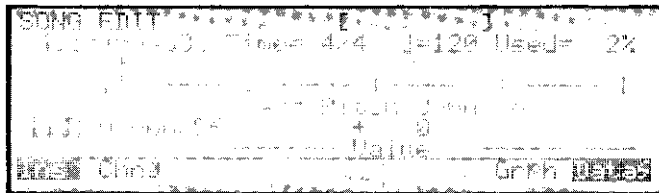

**Control change:** To enter control change data hold **SHIFT** and press **F4 (Ctrl)**. The following display will appear, and you can move the cursor to specify the control change number (Control 0...127) and control change data (Value 0...127). Control change number 123 cannot be selected.

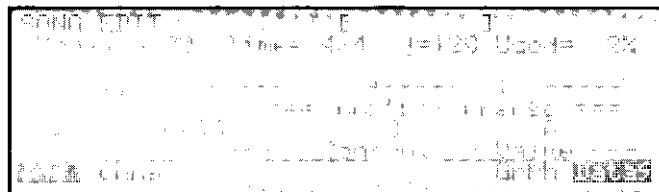

**After touch:** To enter after touch data hold **SHIFT** and press **F5 (AT)**. The following display will appear, and you can move the cursor to specify the aftertouch data (Value 0...127).

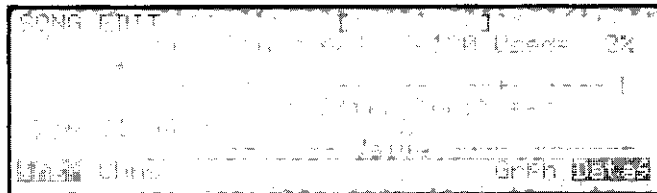

**Relative tempo:** To enter relative tempo data hold **SHIFT** and press **F6 (Temp)**. The following display will appear, and you can move the cursor to specify the relative tempo change data (Value 10%...200%).

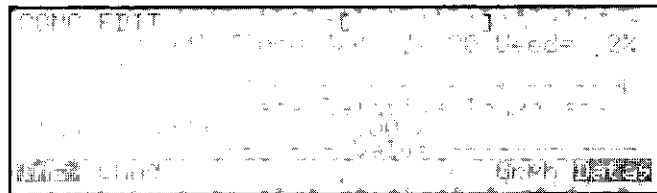

When playback reaches relative tempo data, the playback tempo will change by the specified percentage. Relative tempo data will have an effect only if the SY77 sequencer is synchronized to its own internal clock. Refer to *Song Setup job 2.MIDI Control*.

SONG EDIT

## Chain pattern

**Summary:** Track 16 of the sequencer contains pattern numbers and repeat data. Chain pattern allows you to arrange the pattern and repeat data in this track.

### Procedure:

- From: song mode (when the SONG LED is lit red)
- Press: **EDIT**
- Select: track 16
- Specify: the pattern played by each part, and search, copy, insert, or delete parts.
- To enter: the specified data for each part press **ENTER**.
- To exit: chain pattern mode and return to song play press **EXIT**.



- 1 Track 16 can consist of up to 999 Parts. When the cursor is located at Part, select an existing part 001-999. It is not possible to select a part which contains no data. When you press **ENTER** to enter the specified data for a part, this number will automatically advance to the next part.

- ② Each part in track 16 can be either a pattern number, a begin repeat mark (||:), or an end repeat mark (:||). With the cursor located here, specify the data that will occupy the selected part. To specify a pattern press F1 (Ptn) and specify the pattern number 01–99. To enter a begin repeat mark press F2 (||:). To enter an end repeat mark press F3 (:||) and specify the number of times to repeat. When you press ENTER to enter the specified data for each part, the part number will automatically advance.
- ③ To search for the next occurrence of a begin repeat, end repeat, or specified pattern number, press F5 (Srch). Details are given below.
- ④ To copy a specified range of parts to another range of parts, press F6 (Copy). Details are given below.
- ⑤ To insert a new part into the track, press F7 (Ins). Details are given below.
- ⑥ To delete a specified part from the track, press F8 (Del). Details are given below.

**Repeat marks:** The parts surrounded by repeat begin and repeat end marks will repeat for the specified number of times. For example, if track 16 consists of the following data, it will repeat pattern 01 for 200 times.

Part 001 = ||:  
 Part 002 = PATTERN01w  
 Part 003 = PATTERN01w  
 Part 004 = :|| x99

Repeat marks can be nested if desired. For example, the data in the diagram below will play parts as follows: [05, 12, 05, 12, 05, 12, 07] x 3.

Part	001	002	003	004	005	006	007
	:	:	05	12	:  x2	07	:  x2

**Search:** To search for the next occurrence of a begin repeat, end repeat, or specified pattern number, press F5 (Srch). The lower lines of the display will change as follows.



1. Specify the data you wish to search for. To search for a specific pattern press F1 (Ptn) and specify the number 1–99 for which you are searching. To search for the next begin repeat mark press F2 (||:). To search for the next end repeat mark press F3 (:||).
2. Specify the direction in which you want to search. Each time you press F4 (↔) the display will alternate between “forward” and “backward”.
3. To begin searching press ENTER. To cancel without searching press EXIT.

**Copy part:** To copy a specified range of parts to another range of parts, press F6 (Copy). The lower lines of the display will change as follows.

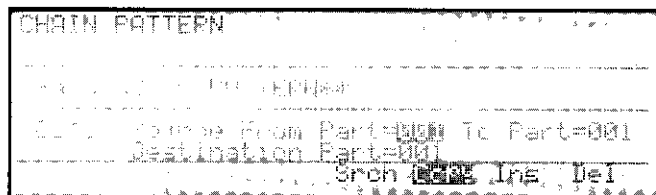

1. Specify the copy source as “From Part” and “To Part”.
2. Specify the copy destination as “Destination Part”.
3. To copy the specified parts press ENTER. To cancel without copying press EXIT. For example if you have specified “From Part=002”, “To Part=003”, and “Destination Part=005”, the contents of track 16 will change as follows.

Before

Part	001	002	003	004	005	006	007	008
Pattern	05	11	12	13	02	01	01	01

After

Part	001	002	003	004	005	006	007	008
Pattern	05	11	12	13	11	12	13	01

## SONG MODE

**Insert part:** To insert a new part into the track, press F7 (Ins). The lower lines of the display will change as follows.

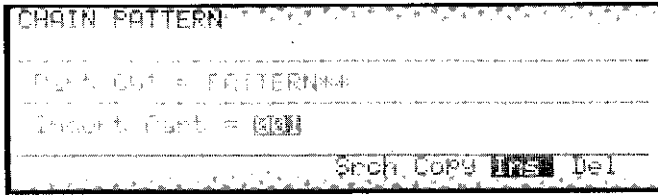

1. Specify the number of the part to be inserted.
2. To insert the specified part press ENTER. To cancel without inserting press EXIT. When a part is inserted the following parts will be moved to make room for it. For example if you have specified "Insert Part=003" the contents of track 16 will change as follows.

Before

Part	001	002	003	004	005	006	007	008
Pattern	05	11	12	13	02	01	01	01

After

Part	001	002	003	004	005	006	007	008
Pattern	05	11	??	12	13	02	01	01

**Delete part:** To delete a specified part from the track, press F8 (Del). The lower lines of the display will change as follows.

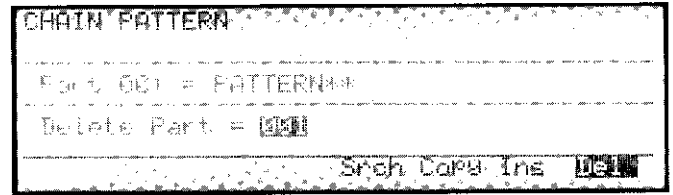

1. Specify the number of the part to be deleted.
2. To delete the specified part press ENTER. To cancel without deleting press EXIT. When a part is deleted the following parts will be moved to fill the gap. For example if you have specified "Delete Part=003" the contents of track 16 will change as follows.

Before

Part	001	002	003	004	005	006	007	008
Pattern	05	11	12	13	02	01	01	01

After

Part	001	002	003	004	005	006	007	...
Pattern	05	11	13	02	01	01	01	



## Song edit jobs

JUMP #600

**Summary:** The song edit job directory contains various operations which allow you to edit the data in specified measures of tracks 1–15 in various ways. Unless otherwise specified, the operation will affect only the track currently selected for editing. These edit jobs can be used only on tracks 1–15. Track 16 contains Part data not sequence data.

**Procedure:**

From: song play or song record mode

Press: F6 (Job) (JUMP #600)

Select: the desired song edit job

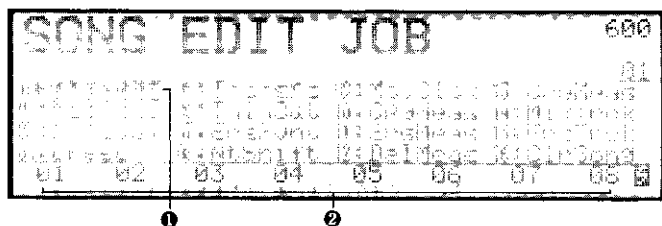

- ① Move the cursor in this area and press ENTER to select the specified job.
- ② Pressing F1–F8 will select the corresponding job 1–8. Holding SHIFT and pressing F1–F8 will select the corresponding job 9–16.

01: Quantiz (Quantize): Adjust the timing of each event in the specified measures of the track to the nearest interval of the specified value.

02: MdfGate (Modify gate time): Modify the gate times (durations) of all notes in specified measures of the selected track.

03: MdfyVel (Modify velocity): Modify the note-on velocity values for all note events in specified measures of the selected track.

04: Cresc (Crescendo): Create a gradual change in note-on velocity over the specified measures of the selected track to create an effect of crescendo or diminuendo.

05: Transps (Transpose): Transpose all notes in specified measures of the track by a specified interval.

06: ThinOut (Thin out): Conserve sequencer memory by deleting approximately every other occurrence of a specified type of continuous controller from specified measures of the track.

07: ErsEvt (Erase event): Erase all data of a specified type from specified measures of the track.

08: NtShift (Note shift): Shift all notes of a specified note number to another note number.

09: MovClck (Move clock): Move events in the specified measures forwards or backward in time.

10: CpyMeas (Copy measure): Copy a specified range of measures in the track to another location in the same track.

11: ErsMeas (Erase measure): Erase all data from specified measures of the track, leaving the measures empty.

12: DelMeas (Delete measure): Delete the specified measures from the track, and move the following measures up to fill the gap.

13: CreMeas (Create measure): Insert empty measures of the specified time signature into the track over the specified range of measures.

14: MixTrck (Mix track): Combine the data of specified measures from a specified track with the data of another track.

15: ErsTrck (Erase track): Erase all data from the specified track(s).

16: ClrSong (Clear song): Erase all data of the entire song.

# 1. Quantize

JUMP #601

**Summary:** This operation adjusts the timing of each event in the specified measures of the track to the nearest interval of the specified value. This can be used to move inaccurately played notes precisely onto the beat

**Procedure:**

From: song edit job directory (JUMP #600)

Select: 01:Quantz (JUMP #601)

Specify: the area of track measures you wish to quantize and set the parameters.

To execute: the operation press ENTER.

To quit: without executing press EXIT.

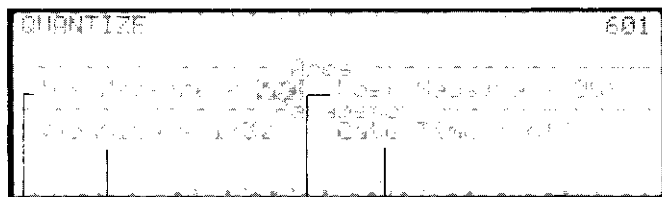

- ① Top Measure (001...999): Specify the first measure to be affected.
- ② Last Measure (001...999): Specify the last measure to be affected.
- ③ Quantize (1/04, 1/06, 1/08, 1/12, 1/16, 1/24, 1/32): Specify the timing interval to which the notes will be quantized. For example if the shortest note value should be a 16th note, specify 1/16. If the music contains triplets, you should use a quantization of 1/06, 1/12, 1/24, or 1/48.

- ④ Gate Time (on, off): Specify whether or not the gate time (duration of the note) should be quantized. If you set this "on", the gate time of each note will also be adjusted to the nearest quantize value you specify.

**Quantize:** The following diagram shows how a track recorded in realtime and played with inaccurate timing would change as a result of quantized at 1/04 and at 1/08.

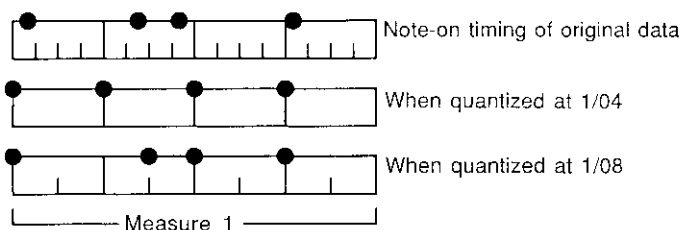

**Gate time:** The following diagram shows how the Gate Time setting will affect the quantized results.

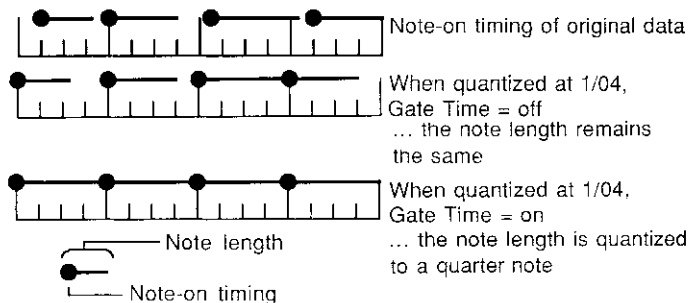

# 2. Modify gate time

JUMP #602

**Summary:** This operation modifies the gate times (durations) of all notes in specified measures of the selected track. Gate times can be modified by a ratio or by an absolute value.

**Procedure:**

From: song edit job directory (JUMP #600)

Select: 02:MdfGate (JUMP #602)

Specify: the area of track measures for which you wish to modify gate time and set the parameters.

To execute: the operation press ENTER.

To quit: without executing press EXIT.

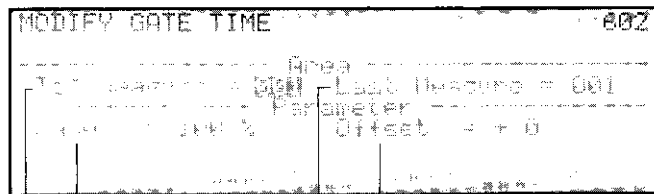

- ① Top Measure (001...999): Specify the first measure to be affected.
- ② Last Measure (001...999): Specify the last measure to be affected.
- ③ Rate (000%...200%): All gate times will be multiplied by the specified percentage. A rate of

100% will result in no change. A rate of 200% will make all gate times twice as long. A rate of 0% will set a gate time of 1.

- ④ Offset (-99...+99): The specified offset will be added to all gate times.

**Remarks:** Each note event in a track has a gate time which determines the duration of the note. The gate time is indicated in units of a 1/384th note (1/96th of a quarter note), and has a range of 0-8188. The modify gate time operation will not increase or decrease the gate time beyond these values.

**Rate and Offset:** These two settings can be used separately or together. First the value is multiplied by the rate, and then the offset is added. The following diagram shows how Rate settings modify the gate time by the specified percentage.

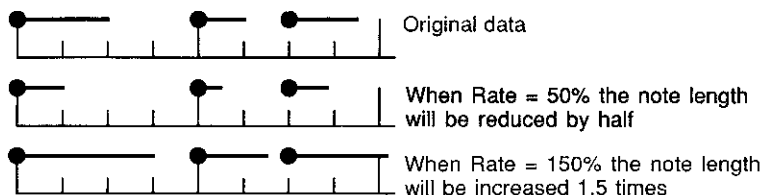

The following diagram shows how Offset settings add the specified value to the original gate time.

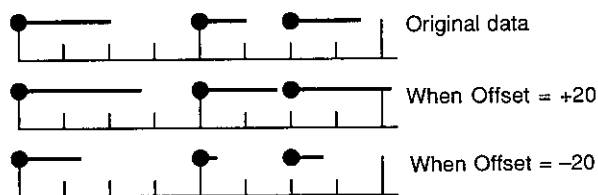

- If you want only to add an absolute value to each gate time, leave rate at 100% so it will have no effect.
- If you want only to multiply each gate time by the same percentage, then leave offset at 0 so it will have no effect.
- If the resulting gate time is 0, the note may be inaudible.
- The gate time is always a multiple of 4.

SONG EDIT JOBS

### 3. Modify velocity

JUMP #603

**Summary:** This operation modifies the note-on velocity values for all note events in specified measures of the selected track.

**Procedure:**

- From: song edit job directory (JUMP #600)
- Select: 03:MdfVel (JUMP #603)
- Specify: the area of track measures for which you wish to modify velocity and set the parameters.

To execute: the operation press ENTER.

To quit: without executing press EXIT.

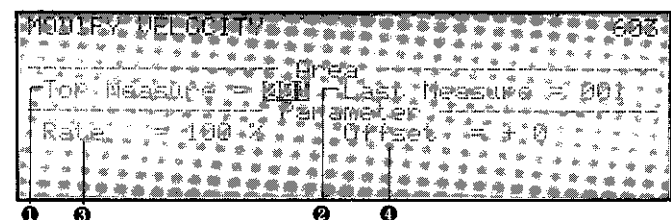

- ① Top Measure (001...999): Specify the first measure to be affected.
- ② Last Measure (001...999): Specify the last measure to be affected.
- ③ Rate (000%...200%): All note-on velocity values will be multiplied around the central value of 64 by the specified percentage. A rate of 100% will result in no change. A rate of 200% will move all velocity values further away from 64; i.e., *expand* the dynamic range. A rate of 0% will set all velocities to the central value of 64; i.e., *compress* the dynamic range.
- ④ Offset (-99...+99): The specified offset will be added to all note-on velocity values.

## SONG MODE

**Remarks:** Each note event in a track has a note-on velocity which determines the force with which the note is played. The velocity has a range of 1–127. This modify velocity operation cannot increase or decrease the velocity beyond these values.

**Rate and Offset:** These two settings can be used separately or together. First the value is multiplied by the specified rate, and then the offset is added.

- If you want only to add an absolute value to each velocity, leave rate at 100% so it will have no effect.
- If you want only to modify each velocity around the central value of 64, then leave offset at 0 so it will have no effect.

SONG EDIT JOBS

## 4. Crescendo

JUMP #604

**Summary:** This operation creates a gradual change in note-on velocity over the specified measures of the selected track to create an effect of crescendo or diminuendo.

**Procedure:**

From: song edit job directory (JUMP #600)  
Select: 04:Cresc (JUMP #604)  
Specify: the area of track measures over which you wish to create a crescendo, and specify the range.

To execute: the operation press ENTER.

To quit: without executing press EXIT.



- ① Top Measure (001...999): Specify the first measure to be affected.
- ② Last Measure (001...999): Specify the last measure to be affected.
- ③ Range (-99...+99): Starting at the beginning of the first measure you specify, note-on velocity will gradually be modified until the increase or decrease specified by the range is reached at the end of the last measure. Settings of +1...+99 will result in a crescendo. Settings of -1...-99 will result in a diminuendo.

**Remarks:** Each note event in a track has a note-on velocity which indicates the force with which the note is played. The velocity value of each note is limited to a range of 1–127, and the velocity values resulting from this operation will not exceed these limits.

If a voice has not been programmed with velocity sensitivity, the velocity value of the note-on message will have no effect on the sound.

**Range:** This specifies the final change in velocity which will be reached at the end of the crescendo or diminuendo. The following diagram shows the result of the Range setting.

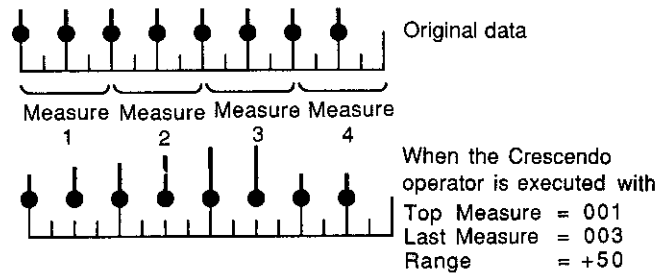

## 5. Transpose

JUMP #605

**Summary:** This operation transposes all notes in specified measures of the track by a specified interval.

**Procedure:**

From: song edit job directory (JUMP #600)

Select: 05:Transpose (JUMP #605)

Specify: the area of track measures which you wish to transpose and set the interval.

To execute: the operation press ENTER.

To quit: without executing press EXIT.

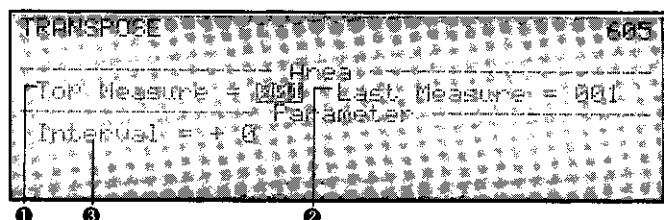

- ❶ Top Measure (001...999): Specify the first measure to be affected.
- ❷ Last Measure (001...999): Specify the last measure to be affected.
- ❸ Interval (-99...+99): The note number of all notes will be transposed by the specified interval. Settings of +1...+99 will transpose upwards, and settings of -1...-99 will transpose downwards. The note number is limited to a range of 0 (C-2) to 127 (G8), and the note numbers resulting from this operation will not exceed these limits.

## 6. Thin out

JUMP #606

**Summary:** This operation conserves sequencer memory by deleting approximately every other occurrence of a specified type of continuous controller from specified measures of the track.

**Procedure:**

From: song edit job directory (JUMP #600)

Select: 06:ThinOut (JUMP #606)

Specify: the area of track measures which you wish to thin out and specify the type of data to be thinned out.

To execute: the operation press ENTER.

To quit: without executing press EXIT.

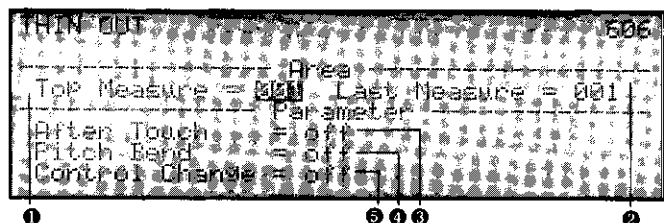

- ❶ Top Measure (001...999): Specify the first measure to be affected.
- ❷ Last Measure (001...999): Specify the last measure to be affected.

- ❸ After Touch (on, off): When this is set "on", channel aftertouch data will be thinned out. (Polyphonic aftertouch is not received or recorded by the SY77.)
- ❹ Pitch Bend (on, off): When this is set "on", pitch bend data will be thinned out.
- ❺ Control Change (on, off): When this is set "on", all continuous control change data will be thinned out. Switch-type controllers such as sustain on/off will not be affected.

**Parameters:** You may thin out more than one type of data at once.

When you move a continuous controller slowly, many messages with closely spaced data will be transmitted. You can usually delete half of them without any audible difference. If you are running low on sequencer memory, thinning out some continuous data can help. Repeating the thin out operation several times will eventually produce rough changes in controller data, which can be an interesting effect in itself.

## 7. Erase event

JUMP #607

**Summary:** This operation erases all data of a specified type from specified measures of the track.

**Procedure:**

From: song edit job directory (JUMP #600)

Select: 07:ErsEvt (JUMP #607)

Specify: the area of track measures from which you wish to erase data, and specify the type of data to be erased.

To execute: the operation press ENTER.

To quit: without executing press EXIT.

- ❶ Top Measure (001...999): Specify the first measure to be affected.
- ❷ Last Measure (001...999): Specify the last measure to be affected.
- ❸ Parameter (Aftertouch, Pitch Bend, Control Change, System Exclusive): Set this to "on" for each type of data you wish to erase.

When you press ENTER all data of the specified types will be erased from the specified range of measures.

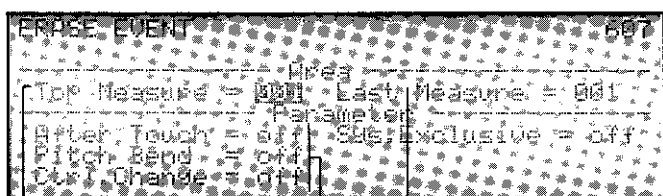

## 8. Note shift

JUMP #608

**Summary:** This operation shifts all notes of a specified note number to another note number.

**Procedure:**

From: song edit job directory (JUMP #600)

Select: 08:NtShift (JUMP #608)

Specify: the area of track measures for which you shift notes, and specify the original and new note numbers.

To execute: the operation press ENTER.

To quit: without executing press EXIT.

- ❷ Last Measure (001...999): Specify the last measure to be affected.
- ❸ Note (C-2...G8 = 000...127): Specify the original note number.
- ❹ To (C-2...G8 = 000...127): Specify the new note number.

When you press ENTER all notes of the number specified by "Note" will be shifted to the note number specified by "To".



- ❶ Top Measure (001...999): Specify the first measure to be affected.

**Remarks:** This operation is often useful when controlling a drum machine from the SY77's sequencer. Most drum machines play specific sounds for each note. For example, shifting all D#2 notes to F#2 might change all snare hits to hi-hat hits. Consult the instrument/note table for your drum machine.

SONG EDIT JOBS

## 9. Move clock

JUMP #609

**Summary:** This operation moves the specified measures of the track forward or backward in time.

**Procedure:**

- From: song edit job directory (JUMP #600)
- Select: 09: MovClck (JUMP #609)
- Specify: the track which you wish to move in time and set the number of clocks by which to move it.

To execute: the operation press ENTER.

To quit: without executing press EXIT.

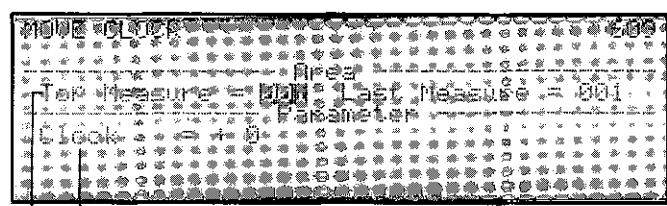

- ① Area (001...999): The measures beginning with the specified Top Measure and ending with the specified Last Measure will be moved in time.

- ② Clock (-99...+99): Specify the number of clocks (units of 1/96th of a quarter note) by which the track is to be moved. Positive settings will move the track forward in time so that it plays later. Negative settings will move the track backward in time so that it plays earlier.

**Remarks:** It is often effective to use clock move to compensate for voices that have a slow attack. For example strings often have a slower attack than other voices, and will appear to be lagging behind the other voices even if the note on messages are actually simultaneous. In such cases you can use move clock to move the strings track earlier in time so that the string voices begin playing a bit before than the other voices, giving the impression of perfect timing.

SONG EDIT JOBS

## 10. Copy measure

JUMP #610

**Summary:** This operation copies a specified range of measures in the track to another location in any number of tracks.

**Procedure:**

- From: song edit job directory (JUMP #600)
- Select: 10: CpyMeas (JUMP #610)
- Specify: the area of source measures from which you wish to copy, the destination measure to which the data will be copied, and the number of times that the data will be copied. Press the memory keys 1-15 to specify one or more destination tracks. The memory LEDs 1-15 will light red to indicate the selected destinations.

To execute: the operation press ENTER.

To quit: without executing press EXIT.

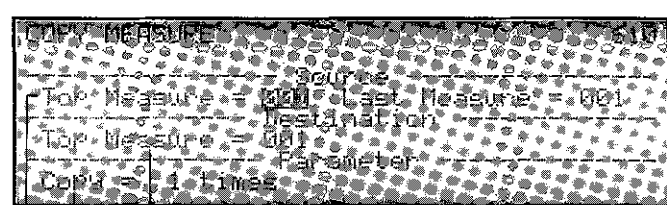

- ① ② ③

- ① Source (001...999): The measures beginning with the specified Top Measure and ending with the specified Last Measure will be copied.
- ② Destination (001...999): The data will be copied into the same track starting at the specified Top Measure.
- ③ Copy (1...99): The specified source measures will be copied as many times as specified here.

**Example:** For track data as shown in the following diagram,

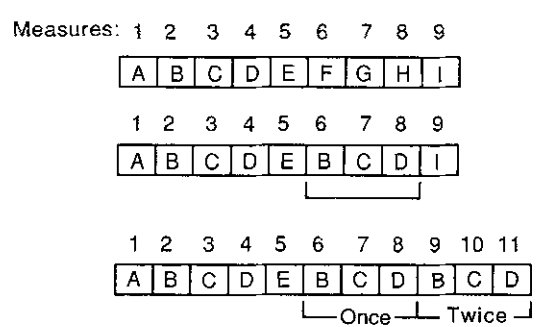

## SONG MODE

using the Copy Measure operation with settings of "Source = 002...004", "Destination=006", and "Copy=1" would change the track data as follows.

Measures:

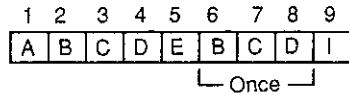

If "Copy=2", the track data would change as follows.

Measures:

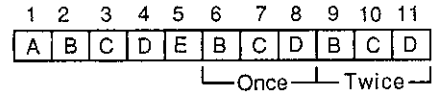

SONG EDIT JOBS

## 11. Erase measure

JUMP #611

**Summary:** This operation erases all data from specified measures of one or more selected tracks, leaving the measures empty.

**Procedure:**

From: song edit job directory (JUMP #600)

Select: 11:ErsMeas (JUMP #611)

Specify: the area of track measures which you wish to erase.

To execute: the operation press ENTER.

To quit: without executing press EXIT.

Measures: 1 2 3 4 5 6 7 8 9



using the Erase Measure operation with settings of "Area = 002...004" would change the track data as shown in the following diagram.

Measures:

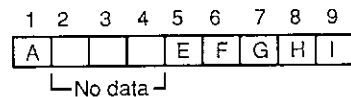

① Area (001...999): The measures beginning with the specified Top Measure and ending with the specified Last Measure will be erased.

**Example:** For track data as shown in the following diagram,



## 12. Delete measure

JUMP #612

**Summary:** This operation deletes the specified measures from one or more selected tracks, and moves the following measures up to fill the gap.

**Procedure:**

From: song edit job directory (JUMP #600)  
 Select: 12:DelMeas (JUMP #612)  
 Specify: the area of measures which you wish to delete. Press the memory keys 1–15 to specify one or more tracks. The memory LEDs will light red to indicate selected tracks.

To execute: the operation press ENTER.

To quit: without executing press EXIT.

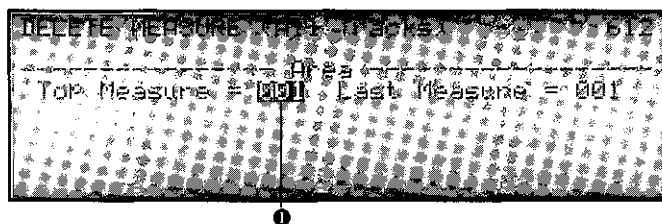

- ① Area (001...999): The measures beginning with the specified Top Measure and ending with the specified Last Measure will be deleted.

**Example:** For track data as shown in the following diagram,

Measures: 1 2 3 4 5 6 7 8 9

A	B	C	D	E	F	G	H	I
---	---	---	---	---	---	---	---	---

using the Delete Measure operation with settings of “Area = 002...004” would change the track data as follows.

Measures:

1 2 3 4 5 6

A	E	F	G	H	I
---	---	---	---	---	---

## 13. Create measure

JUMP #613

**Summary:** This operation inserts empty measures of the specified time signature into one or more selected tracks over the specified range of measures. The following measures will be pushed back to make room.

**Procedure:**

From: song edit job directory (JUMP #600)  
 Select: 13:CreMeas (JUMP #613)  
 Specify: the area of measures to be created and set the time signature. Press the memory keys 1–15 to specify one or more tracks. The memory key LEDs will light to indicate selected tracks.

To execute: the operation press ENTER.

To quit: without executing press EXIT.

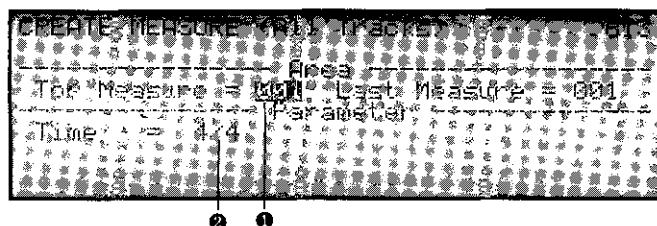

- ① Area (001...999): New measures beginning with the specified Top Measure and ending with the specified Last Measure will be created and inserted.
- ② Time (1–8/4, 1–16/8, 1–32/16): Specify the time signature of the measures you wish to create.

## SONG MODE

**Example:** For track data as shown in the following diagram,

Measures:	1	2	3	4	5	6	7	8	9
Track	A	B	C	D	E	F	G	H	I

using the Create Measure operation with settings of "Area = 002...004" would change the track data as follows.

Measures:	1	2	3	4	5	6	7	8	9	10	11	12
Track	A				B	C	D	E	F	G	H	I

SONG EDIT JOBS

## 14. Mix track

JUMP #614

**Summary:** This operation combines the data of specified measures from a specified track with the data of another track.

**Procedure:**

- From: song edit job directory (JUMP #600)
- Select: 14:MixTrck (JUMP #614)
- Specify: the source track and the measures which you wish to mix into the destination track, and specify the destination track.

To execute: the operation press ENTER.

To quit: without executing press EXIT.

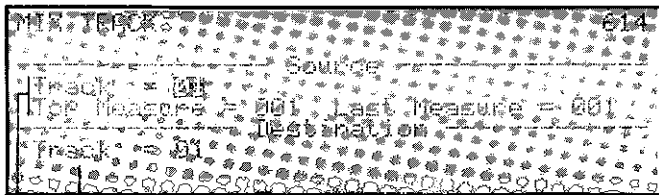

- ① Source (Track 01...15, Measures 001...999): Specify the source track and area of measures.
- ② Destination (Track 01...15): Specify the destination track into which the measures specified by ① will be mixed.

**Example:** For track data as shown in the following diagram,

Measures:	1	2	3	4	5	6	7	8	9
Track 1	A	B	C	D	E	F	G	H	I
Track 2	a	b	c	d	e	f	g	h	i

using the Mix Track operation with settings of "Source Track = 01", "Source Measures = 002...004", and "Destination Track = 02" would change the data as follows.

Track 1	1	2	3	4	5	6	7	8	9
Track 2	A	B	C	D	E	F	G	H	I
	a	b	c	d	e	f	g	h	i
		B	C	D					

SONG EDIT JOBS

## 15. Erase track

JUMP #615

**Summary:** This operation erases all data from the specified track(s).

**Procedure:**

- From: song edit job directory (JUMP #600)

Select: 15:ErsTrck (JUMP #615)

Specify: the track(s) to be erased

To execute: the operation press ENTER.

To quit: without executing press EXIT.

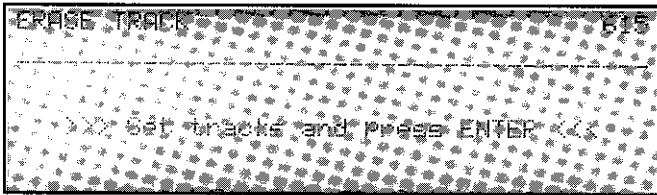

There are no parameters to set for this operation. Use the memory select 1–16 buttons to specify the track(s) to be erased. The LEDs of selected track will light red. When you press ENTER the data will be erased from the selected tracks.

SONG EDIT JOBS

## 16. Clear song

JUMP #616

**Summary:** This operation erases all data from the entire song.

**Procedure:**

From: song edit job directory (JUMP #600)

Select: 16:ClrSong (JUMP #616)

To execute: the operation press ENTER.

To quit: without executing press EXIT.

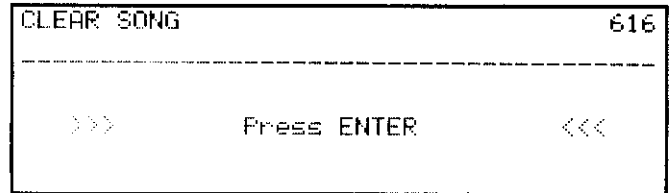

There are no parameters to set for this operation. If you are sure you want to clear the song, press ENTER and the song will be cleared.

## Song setup jobs

JUMP #617

**Summary:** Song setup parameters affect the overall functioning of the sequencer.

**Procedure:**

From: song play mode or song record mode  
 Press: F7 (Stup) (JUMP #617)  
 Select: the desired song setup job.

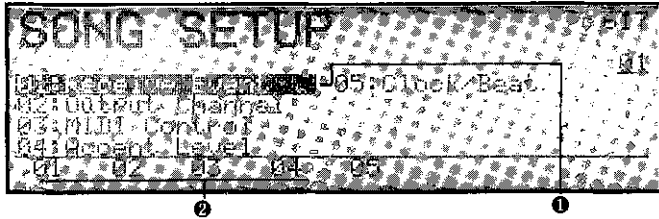

- ① Move the cursor in this area and press ENTER to select the specified job.
- ② Pressing F1–F5 will select the corresponding job 1–5.

- 01: Receive Event: To conserve sequencer memory, you can specify that unwanted types of data not be recorded.
- 02: Output Channel: Specify the MIDI channel on which each track of the sequencer will transmit its data.
- 03: MIDI Control: Specify whether the SY77's sequencer will be controlled by its own timing source or by an external sequencer.
- 04: Accent Level: Specify the accent level for each of the four function keys F1–F4 used to specify the accent of a note in song step record mode.
- 05: Clock/Beat: Set the number of clocks per beat that will be displayed in editing.

### SONG SETUP JOBS

## 1. Receive event

JUMP #618

**Summary:** You can specify that unwanted types of data not be recorded, so as to conserve sequencer memory.

**Procedure:**

From: song setup job directory (JUMP #617)  
 Select: 01:Receive Event (JUMP #618)  
 Specify: reception on/off for each type of data.  
 To exit: to the song setup job directory press EXIT.

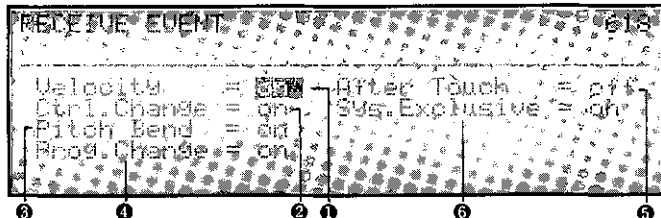

- ① Velocity (on, off): Specify whether the velocity value of note-on messages will be recorded by the sequencer. When this is set "off", all notes will be recorded with a velocity of 64 regardless of their original velocity.
- ② Control Change (on, off): Specify whether or not control change messages will be recorded by the sequencer.

- ③ Pitch Bend (on, off): Specify whether or not pitch bend messages will be recorded by the sequencer.
- ④ Program Change (on, off): Specify whether or not program change messages will be recorded by the sequencer.
- ⑤ After Touch (on, off): Specify whether or not after touch messages will be recorded by the sequencer.
- ⑥ System Exclusive (on, off): Specify whether or not system exclusive messages will be recorded by the sequencer. The SY77 sequencer can not record system exclusive messages which are longer than 32 bytes.

**Remarks:** In order to conserve sequencer memory, turn off the reception for types of data that do not affect the voices you are using. For example if the voices have not been programmed with aftertouch sensitivity, turn aftertouch reception off so that the sequencer memory does not fill up with meaningless data.

## SONG SETUP JOBS

## 2. Output channel

JUMP #619

**Summary:** Specify the MIDI channel on which each track of the sequencer will transmit its data.

**Procedure:**

- From: song setup job directory (JUMP #617)  
 Select: 02:Output Channel (JUMP #619)  
 Specify: the MIDI transmission channel for each track.  
 To exit: to the song setup job directory press EXIT.

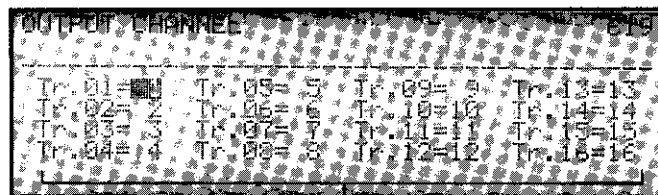

- ① Tracks 1–16 (1...16): Specify the channel 1–16 on which each track will transmit data from the rear panel MIDI OUT.

## SONG SETUP JOBS

## 3. MIDI control

JUMP #620

**Summary:** Specify whether the SY77's sequencer will be controlled by its own timing source or by an external sequencer.

**Procedure:**

- From: song setup job directory (JUMP #617)  
 Select: 03:MIDI Control (JUMP #620)  
 Specify: MIDI Control on or off.  
 To exit: to the song setup job directory press EXIT.

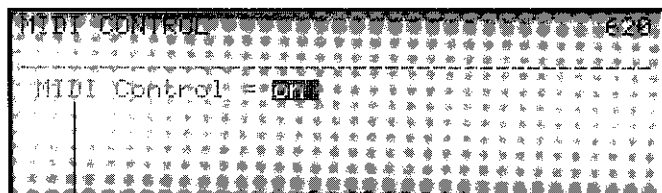

- ① MIDI Control (on, off): Normally you will leave this set off so that the SY77 sequencer will be controlled by its own timing clock and the front panel sequencer control buttons.

If you want to use an external sequencer connected to the SY77's MIDI IN to control the SY77 sequencer, set this to on so that the SY77 sequencer will be controlled by MIDI start/continue/stop messages and the tempo will be determined by MIDI clock messages.

**Remarks:** When MIDI control is on, the SY77 sequencer will not run unless MIDI clock messages are being received.

## SONG SETUP JOBS

## 4. Accent level

JUMP #621

**Summary:** Specify the accent level for each of the four function keys F1–F4 used to specify the accent of a note in song step record mode.

**Procedure:**

- From: song setup job directory (JUMP #617)  
 Select: 04:Accent Level (JUMP #621)  
 Specify: each of the four accent levels.  
 To exit: to the song setup job directory press EXIT.

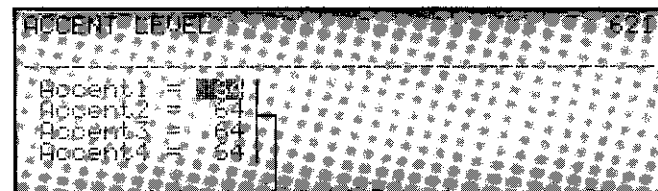

- ① Accent 1 – Accent 4 (1...127): These determine the accent levels that will be selected when a function key F1–F4 (Acc1–Acc4) is pressed while in song step record mode.

## 5. Clock/Beat

JUMP #622

**Summary:** Set the number of clocks per beat that will be displayed in editing.

**Procedure:**

From: song setup job directory (JUMP #617)

Select: 05:Clock/Beat (JUMP #622)

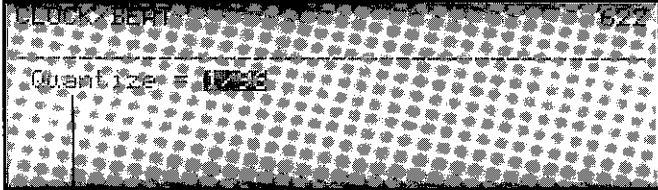

- ❶ Quantize (1/6, 1/8, 1/12, 1/16, 1/24, 1/32, 1/48, 1/64, 1/96): Specify the time value of one displayed beat.

This sets the number of clocks per beat that will be displayed in editing. This has no effect on the time signature, but is simply a convenience for editing.

## Song name

JUMP #623

**Summary:** The sequencer song can be given an eight-character name, which will be displayed in song play or song record mode.

**Procedure:**

From: song play or song record mode

Press: F8 (Name) (JUMP #623)

Specify: the song name.

To exit: to the previous display press EXIT.

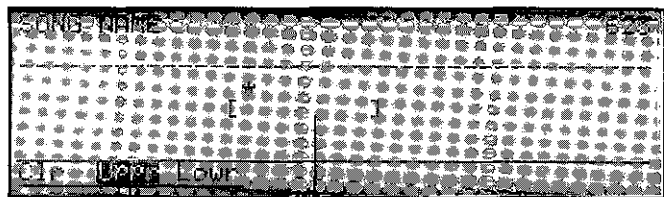

- ❶ Enter a eight-character name for the sequencer song.
- ❷ To clear the currently entered name press F1 (Clr). To switch to upper-case characters press F2 (Uppr). To switch to lower-case characters press F3 (Lowr).

**Remarks:** Methods of entering character data are explained in *Introducing the SY77, How to use the numeric key pad.*





# PATTERN MODE

Pattern mode allows you to record and playback Patterns of 1 to 32 measures. These patterns can be edited in various ways, and a different pattern can be placed in each Part of track 16 (the pattern track) to play frequently repeating phrases or rhythm patterns.

<b>Contents of this section</b>	<b>page</b>
<b>Pattern play</b> .....	<b>204</b>
<b>Pattern record</b> .....	<b>205</b>
<b>Pattern edit</b> .....	<b>209</b>
<b>Pattern edit jobs</b> .....	<b>210</b>
<b>Pattern setup jobs</b> .....	<b>213</b>
<b>Clear pattern</b> .....	<b>214</b>

## PATTERN MODE

In pattern mode you can record and playback Patterns of 1 to 32 measures. Editing functions in song mode allow you to place these patterns in track 16 (the pattern track). Since the same pattern can be placed in more than one part of track 16, you can save time and sequencer memory by creating a pattern for each frequently appearing motif and assigning it to the appropriate location every time you want it to playback.

Patterns are often used to play a drum-type voice from track 16 of the sequencer, as shown in the following diagram.

Since the transmission channel of each sequencer track can be modified, make sure that track 16 is transmitting its data on a channel that will be received by the voice in the multi which you want the patterns to be played by.

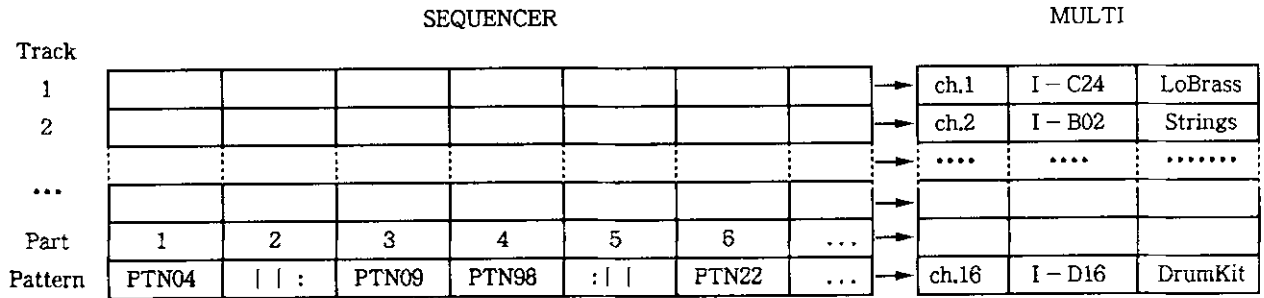

For details of how to place parts in track 16, refer to *Song edit, Chain pattern*.

## How pattern play mode and pattern edit mode are organized

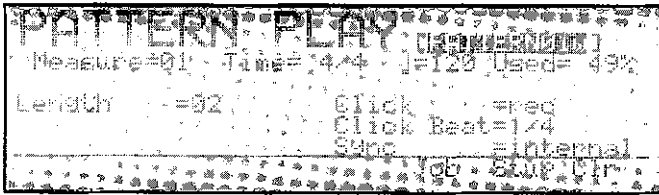

- 01:Copy Pattern
- 02:Get Pattern
- 03:Put Pattern

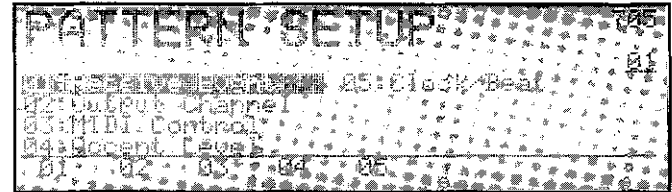

- 01:Receive Event
- 02:Output Channel
- 03:MIDI Control
- 04:Accent Level
- 05:Clock/Beat

From the Pattern Play display you can press F6 to enter the Pattern Edit Job job directory, F7 to enter the Pattern Setup job directory, or F8 to clear a selected pattern or all patterns.

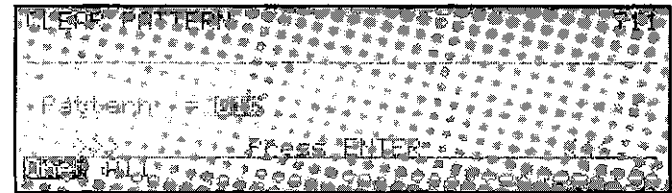

## Pattern play

**Summary:** In pattern play mode you can select and playback any pattern 01–99. You can also make settings for the click (metronome) and synchronization.

**Procedure:**

Press: PATTERN to enter pattern play mode. The PATTERN LED will light red.

Select: the pattern to playback.

To start: playback press RUN.

To stop: playback press STOP.

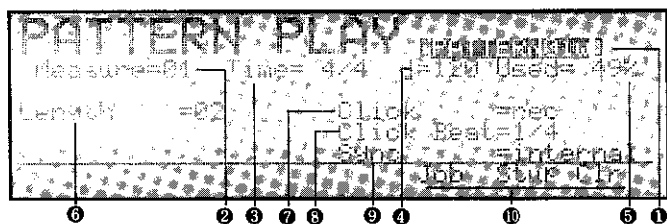

- ❶ Pattern (01...99): This selects the pattern to playback.
- ❷ Measure (001...032): This determines the measure from which the pattern will begin playback. Move the cursor here and specify the measure, or by using the sequencer location buttons (<|, <<|, LOCATE, or >>|).
- ❸ Time (1/4...32/16): This displays the time signature for this pattern as you specified in pattern record mode. This cannot be modified in pattern play mode.
- ❹ (30...250): This determines the tempo in quarter notes per minute.
- ❺ Used (0...100%): This displays the amount of used sequencer memory.
- ❻ Length (1...32): This displays the length of the pattern.
- ❼ Click (off, rec, rec/play, always): This determines when the click (metronome) will sound.
  - off: The metronome will not sound.
  - rec: The metronome will sound only during recording.
  - rec/play: The metronome will sound during recording or playback.
  - always: The metronome will sound constantly.

- ❸ Click Beat (1/4, 1/6, 1/8, 1/12, 1/16, 1/24): This determines the beat on which the click will sound.
- ❹ Sync (internal, MIDI): This determines the timing source which will control the sequencer. Normally you will leave this set to internal so that the SY77's own clock will determine the tempo.

If you are using an external MIDI sequencer and want the SY77's sequencer to play in synchronization with it, set this to MIDI so that MIDI clock messages received at MIDI IN will determine the tempo.

- ❿ Press F6 to move to the Pattern Edit Job job directory, F8 to move to the Pattern Setup job directory, or F8 to clear the selected pattern or all patterns.

**Start and stop playback:** Press RUN and the pattern will begin playback from the point specified by the measure setting. Press STOP and playback will stop.

**During playback:** During playback you can select another pattern, and modify the tempo, click, and click beat settings.

Patterns which contain no data cannot be selected. When you change the pattern number during playback, the currently playing pattern will finish before the newly selected pattern begins.

**Pattern edit:** Any time while in pattern play mode you can press EDIT to edit the pattern. For details refer to *Pattern edit mode*.

## Pattern record

**Summary:** In pattern record mode you can make settings in preparation to recording a pattern. You can specify either realtime or step recording, set the time signature and length of the pattern, and make other settings for click and sync as in the Pattern Play display.

**Procedure:**

From: pattern play display

Press: RECORD and the RECORD LED will light.

Select: the recording mode.

To begin: recording press RUN.

To end: recording press STOP.

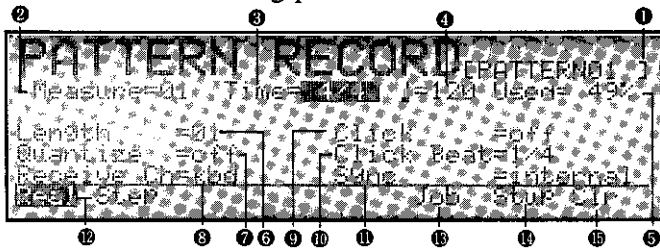

- ❶ PATTERN (01...99): Select the pattern you wish to record.
- ❷ Measure (01...32): This determines the measure from which the pattern will begin playback. You can modify this by moving the cursor here and specifying the measure, or by using the sequencer location buttons (◀, ◀◀, LOCATE, or ▶▶).
- ❸ Time (01-08/4, 01-16/08, 01-32/16): This determines the time signature of the pattern to be recorded. It can be modified only for patterns which have not yet been recorded.
- ❹  $\text{♩}$  (30...250): This determines the tempo in quarter notes per minute.
- ❺ Used (0...100%): This displays the amount of unused sequencer memory.
- ❻ Length (1...32): This indicates the length of the pattern. It can be modified only if the pattern has not yet been recorded.
- ❼ Quantize (off, 1/32, 1/16, 1/8, 1/4, 1/2): This determines the timing accuracy to which the notes you play will be corrected. When quantization is turned off the notes you play will be recorded at the exact timing they occur. When a quantization of 1/32...1/2 is selected, all notes you play will be moved to the nearest timing at the specified interval.

- ❽ Receive Channel (1-16, omni, kbd): This determines the source of data that will be recorded by the sequencer. Normally you will set this to "kbd" so that data from the SY77's keyboard will be recorded.

If you want to record data from an external MIDI device on a specific channel, set this to 1-16 so that data received at MIDI IN on the specified channel will be recorded.

If you want to record data from an external MIDI device on all channels then set this to "omni" so that all data received at MIDI IN will be recorded.

- ❾ Click (off, rec, rec/play, always): This determines when the click (metronome) will sound.
  - off: The metronome will not sound.
  - rec: The metronome will sound only during recording.
  - rec/play: The metronome will sound during recording or playback.
  - always: The metronome will sound constantly.
- ❿ Click Beat (1/4, 1/6, 1/8, 1/12, 1/16, 1/24): This determines the beat on which the click will sound.
- ⓫ Sync (internal, MIDI): This determines the timing source which will control the sequencer. Normally you will leave this set to internal so that the SY77's own clock will determine the tempo.
  - If you are using an external MIDI sequencer and want the SY77's sequencer to play in synchronization with it, set this to MIDI so that MIDI clock messages received at MIDI IN will determine the tempo.
- ⓬ Recording mode (Real, Step): Press F1 or F2 to select the recording mode.
  - Realtime recording (press F1): Notes will be recorded at the exact time you play them.
  - Step recording (press F2): Notes will be recorded one by one with the specified time value, regardless of the actual timing at which you play.
- ⓭ To move to the Pattern Edit Job job directory press F6.
- ⓮ To move to the Pattern Setup job directory press F7.
- ⓯ To clear a pattern or all patterns press F8.

## PATTERN MODE

### Pattern recording procedure:

1. Select the pattern to record.
2. If the selected pattern has not yet been recorded, specify the time signature and length.
3. Make setting for tempo, quantize, receive channel, click, click beat, and sync.
4. Specify the recording mode; realtime (F1) or step (F2).

5. Press RUN and pattern recording will begin. The recording display will depend on the recording mode selected in step 2. For details see the following sections; *Pattern realtime record* or *pattern step record*.
6. When you are finished recording press STOP and you will return to the pattern play display.

**Pattern edit:** Any time while in pattern record mode you can press EDIT to edit the pattern. For details refer to *Pattern edit mode*.

## PATTERN RECORD

### Pattern realtime record

**Summary:** In realtime recording the notes you play will be recorded in the exact timing with which you play them. Newly recorded notes will be added to the previous data in the pattern.

#### Procedure:

From: pattern record display

Press: F1 (Real) to select realtime recording.

To begin: recording press RUN. The RUN LED will blink at tempo.

To stop: recording and return to the song play display press STOP.

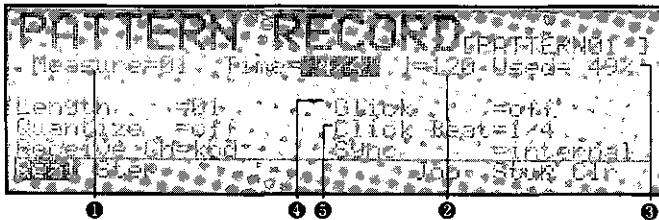

- ① Measure (01...32): As you record this will advance to show the currently recorded measure number of the pattern.
- ② | (30...250): While recording you can move the cursor here to modify the tempo.
- ③ Used (0...100%): As you record this will increase to show the amount of sequencer memory that has been used.
- ④ Click (off, rec, rec/play, always): While recording you can move the cursor here and specify when the click (metronome) will sound.  
off: The metronome will not sound.

rec: The metronome will sound only during recording.

rec/play: The metronome will sound during recording or playback.

always: The metronome will sound constantly.

- ⑤ Click Beat (1/4, 1/6, 1/8, 1/12, 1/16, 1/24): While recording you can move the cursor here and specify the beat on which the click will sound.

**Remarks:** While recording you can modify the settings for tempo, click, and click beat. To modify the other parameters you must return to the pattern record display.

Unlike song realtime recording, pattern realtime recording gives you no choice of overdub or replace recording modes. Pattern recording is always in overdub mode, meaning that newly recorded notes will be added to the previous data in the pattern.

In realtime pattern recording the pattern will continue to repeat from beginning to end until you press STOP. This allows you to build up complex rhythmic parts one note at a time.

**To delete:** During realtime recording, you can delete any given note from the pattern by pressing SHIFT while holding down the key of the unwanted note.

Allow the pattern to run through the section you wish to erase.

## Pattern step record

**Summary:** In step recording the notes you play will be recorded at intervals of the specified step, regardless of the actual exact timing with which you play them. Newly recorded notes will be added to the previous data in the pattern.

**Procedure:**

From: the pattern record display

Press: F2 (Step) to select step recording.

To begin: recording press RUN. The RUN LED will light green.

To stop: recording and return to the song play display press STOP.

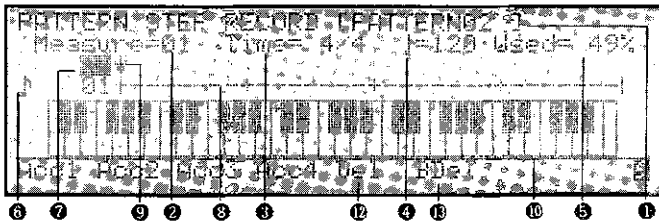

- ① Pattern (01..99): Select the pattern to record.
- ② Measure (01...32): To move to another measure in the pattern, place the cursor here and modify the data.
- ③ Time (01-08/4, 01-16/08, 01-32/16): The time signature is only displayed and cannot be modified.
- ④ ♩: The tempo is only displayed and cannot be modified.
- ⑤ Used (0...100%): This displays the amount of sequencer memory already used.
- ⑥ This area indicates the currently selected note value. At any time in step recording you can use the numeric keypad to enter note values. You can also move the cursor to this area and modify the note values. If possible, the note values in this area will be displayed as graphic symbols for a whole note, quarter note, etc. Otherwise the note value will displayed as a number of clocks (1/384th notes).
- ⑦ When the cursor is located in this area you can move backwards and forwards through the data in time. If the current measure is longer than four quarter notes (e.g., a time signature of 10/8), a number will be displayed here to indicate the section of the measure now being displayed.

- ⑧ This bar represents one measure, and vertical divisions represent one beat. A dot will be displayed on the bar to indicate a 32nd note area which contains data.
- ⑨ As you move backward or forward through the data in time, an arrow pointing downward will move in 32nd note steps to indicate the current position in the measure.
- ⑩ If the currently selected 32nd note area contains data, the notes in that area will be displayed on the keyboard diagram.
- ⑪ To select an accent value, press F1-F4. Subsequently entered notes will be given the selected accent value. To change the accent value assigned to F1-F4 refer to *Pattern setup job 4. accent level*.
- ⑫ To delete all data in the 32nd note area where the cursor is located, press F5 (Del). The cursor location will not change.
- ⑬ To delete all data in the 32nd note area before the cursor, press F6 (BDel). The cursor will move back one 32nd note.

**Note duration:** To specify how long the note will be held in relation to its note value hold SHIFT and press F1-F3. To record normal notes which sound for 80% of their note values press F1 (Norm). To record staccato notes which sound for 50% of their note values press F2 (Stac). To record slurred notes which sound for 99% of their note value press F3 (Slur).

**Numeric keypad:**

- Note value (numeric keys 1-8): Use the numeric keys 1-8 to specify the note value to be recorded. Pressing each key will select the note value printed above it, from a whole note (key 1) to a 8th note triplet (key 8). This also determines the step time by which the cursor will automatically advance after each note has been entered.
- Dot (numeric key 9): To dot the current note value press numeric key 9. The current note value will be extended by 50%.

## PATTERN MODE

- Tie (numeric key “-”): To extend the duration of the previously entered note, press TIE. The duration of the note will be extended by the current note value, and the cursor will advance accordingly.
- Rest (numeric key 0): To advance one step without entering data press REST.

### **Recording procedure:**

- Entering notes: Each time you press and release a key it will be recorded, and the position will move ahead one step as specified by the step time. The note will not be entered until all keys have been released. This allows you to enter more than one note at the same location by pressing more than one note before releasing the first.

- Move through the data: When the cursor is located at ⑦ you can also use the cursor keys <|> to move back and forth in the pattern, and enter notes wherever you like. When you come to note data, it will be displayed on the keyboard diagram below and sounded on the synthesizer.
- To stop recording: When you are finished recording the pattern press STOP. You will return to the pattern play display, where you can press RUN and hear the pattern you just recorded.



## Pattern edit

**Summary:** This is where you edit individual events that have been recorded in a pattern.

**Procedure:**

From: pattern play or pattern record mode

Press: EDIT.

To exit: edit mode and return to pattern play mode press EXIT.

The pattern edit display will differ according to whether graph or data editing has been selected.

**Pattern graph editing:** To select graphic editing press F7 (Grph). The display will show a horizontal bar to indicate the position in the measure, and a keyboard diagram to indicate the notes that have been recorded at each step.

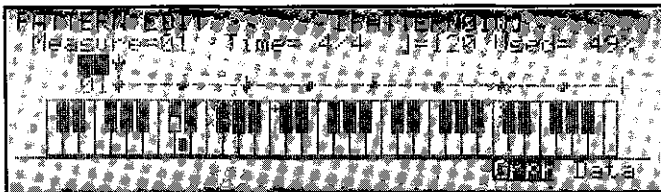

Pattern graph editing is exactly the same as song graph editing, except that the pattern number is displayed instead of the song name, and that the maximum measure number is 32 instead of 999. For details, please refer to *Song edit (graph)* on page 179.

**Pattern data editing:** To select data editing press F8 (Data). The display will show the type and numerical values for each event. Data editing is divided into two modes; graph mode and data mode. In data mode you can either Change or Insert data. When you enter data mode, change will automatically selected.

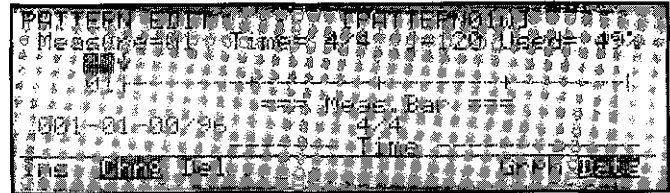

Pattern data editing is exactly the same as song data editing, except that the pattern number is displayed instead of the song name, and that the maximum measure number is 32 instead of 999. For details, please refer to *Song edit (data insert)* on page 181 or *Song edit (data change)* on page 180.

# Pattern edit jobs

JUMP #700

**Summary:** Pattern edit jobs allow you to copy a pattern to another pattern, copy data from a track into a pattern, copy data from a pattern into a track, or copy the pattern data of all parts into a track.

**Procedure:**

From: the pattern play or pattern record display  
 Press: F6 (Job).

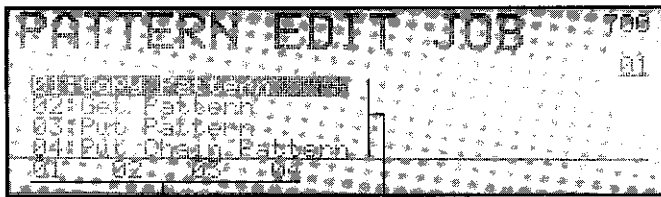

- ❶ Move the cursor in this area and press ENTER to select the specified job.
- ❷ Pressing F1–F4 will select the corresponding job 1–4.

- 01: Copy Pattern: Copy a pattern to another pattern.
- 02: Get Pattern: Copy data from specified measures of a track into a pattern.
- 03: Put Pattern: Copy data from a pattern into specified measures of a track.
- 04: Put Chain Pattern: Copy the pattern data of all parts into a specified track 1–15.

PATTERN EDIT JOBS

## 1. Copy pattern

JUMP #701

**Summary:** This operation copies a pattern to another pattern. This is useful when you want to create a new pattern that is similar to an already existing pattern.

**Procedure:**

From: the pattern edit job (JUMP #700) directory  
 Select: 01:Copy Pattern (JUMP #701)  
 Specify: the Source pattern and the Destination pattern.

To execute: the operation press ENTER.

To quit: without executing press EXIT.

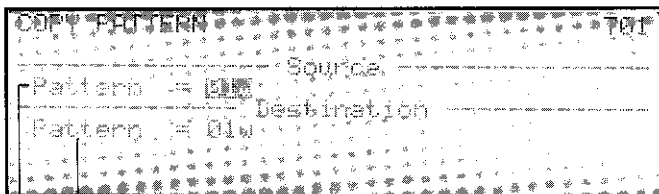

- ❶ Source pattern (01...99): Specify the pattern you wish to copy.
- ❷ Destination pattern (01...99): Specify the pattern into which you wish to copy the source pattern. The previous data in the destination pattern will be lost.

**Example:** For settings of Source = pattern 3, Destination = pattern 5, the result would be as follows.

Before				After			
Measure	1	2	3	Measure	1	2	3
Pattern 3	A	B	C	Pattern 3	A	B	C
Pattern 5	X	Y	Z	Pattern 5	A	B	C

## 2. Get pattern

**Summary:** Copy data from specified measures of a track 1-15 into a pattern.

**Procedure:**

From: the pattern edit job (JUMP #700) directory

Select: 02:Get Pattern. (JUMP #702)

Specify: the source track and the measures from which to copy the data, and specify the destination pattern into which to copy the data.

To execute: the operation press ENTER.

To quit: without executing press EXIT.



- 1 Source (Track 01...15, Top Measure 001...???, Last Measure 001...???): Specify the track and measures from which to copy the data. Since the

maximum length of a pattern is 32 measures, the last measure can be no more than 32 measures after than the top measure. Also, it is not possible to select measures which contain differing time signatures.

- 2 Destination (Pattern 01...99): Specify the pattern into which the data will be copied.

The previous data in the destination pattern will be lost.

**Example:** For settings of "Source = track 2 measures 2-3, Destination = pattern 5", the result would be as follows.

Before	1 2 3 4 5 6 7 8 9 ...
Measure	A B C D E F G H I ...
Track 2	
Pattern 5	
After	1 2 3 4 5 6 7 8 9 ...
Measure	A B C D E F G H I ...
Track 2	B C
Pattern 5	

## 3. Put pattern

**Summary:** Copy data from a pattern into specified measures of a track.

**Procedure:**

From: the pattern edit job (JUMP #700) directory

Select: 03:Put Pattern. (JUMP #703)

Specify: the source pattern, and specify the destination track and measure at which to copy the data from the pattern.

To execute: the operation press ENTER.

To quit: without executing press EXIT.

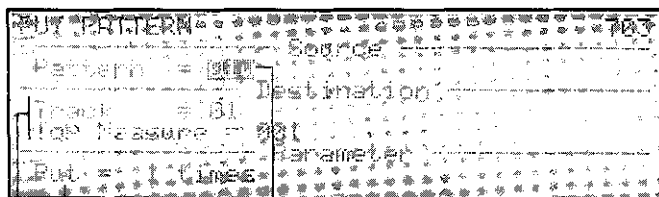

- 1 Source (Pattern 01...99): Specify the pattern from which the data will be copied.
- 2 Destination (Track 01...15, Top Measure 001...???): Specify the track and measures to which the data will be copied.
- 3 Put (1...99): Specify the number of times that the data will be copied from the pattern.

**Example:** For settings of "Source = pattern 5, Destination = track 2, measure 4, Put Time = 2" the result would be as follows.

Before	1 2 3 4 5 6 7 8 9 ...
Measure	Z Z Z Z Z Z Z Z Z ...
Track 2	
Pattern 5	A B
After	1 2 3 4 5 6 7 8 9 ...
Measure	Z Z Z A B A B Z Z ...
Track 2	
Pattern 5	A B

## 4. Put chain pattern

**Summary:** Copy the data of all patterns used by track 16 (the pattern track) into a specified track 1-15.

**Procedure:**

From: the pattern edit job (JUMP #700)  
directory

Select: 04:Put Chain Pattern (JUMP #704)

Specify: the destination track

To execute: the operation press ENTER.

To quit: without executing press EXIT.

❶ Destination (Track 01...15): Specify the track to which the data will be copied. The previous data in the destination track will be lost.

**Remarks:** If the amount of data is large, some time may be required for the data to be copied. Since this operation copies the actual data of each pattern as many times as it is used in a pattern, the resulting destination track will occupy more memory than original pattern data.



❶

## Pattern setup jobs

JUMP #705

**Summary:** Setup parameters affect the overall functioning of the sequencer.

**Procedure:**

From: the pattern play or pattern record display  
 Press: F7 (Stup) (JUMP #705)  
 Select: the desired pattern setup job

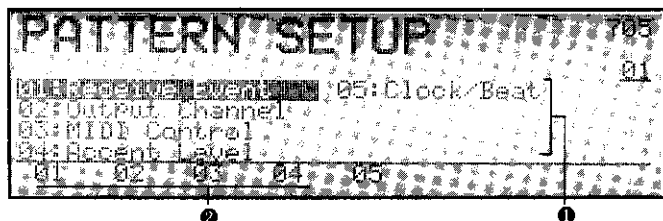

- ① Move the cursor in this area and press ENTER to select the specified job.
- ② Pressing F1–F5 will select the corresponding job 1–5.

01: Receive Event: To conserve sequencer memory, you can specify that unwanted types of data not be recorded.

02: Output Channel: Specify the MIDI channel on which each track of the sequencer will transmit its data.

03: MIDI Control: Specify whether the SY77's sequencer will be controlled by its own timing source or by an external sequencer.

04: Accent Level: Specify the accent level for each of the four function keys F1–F4 used to specify the accent of a note in song step record mode.

05: Clock/Beat: Set the number of clocks per beat that will be displayed in editing.

*Note: These Setup parameters can also be set from Song play or Song record mode. The result is exactly the same whether you set them from Pattern or from Song mode. For details refer to Song setup jobs.*

## Clear pattern

JUMP #711

**Summary:** All data can be cleared from any specified pattern or from all patterns 01–99.

**Procedure:**

From: the pattern play or pattern record display

Press: F8 (Clr) (JUMP #711)

Specify: whether to clear a single pattern or all patterns.

To execute: the operation press ENTER.

To quit: without executing press EXIT.

- ❶ Pattern (01...99): If you have pressed F1 (One), specify the pattern to be cleared.
- ❷ To clear a single pattern press F1 (One) and specify the pattern.
- ❸ To clear all patterns press F2 (All).

**Remarks:** If you clear one pattern or all patterns, the data will be lost forever. There is no way of recalling a pattern.

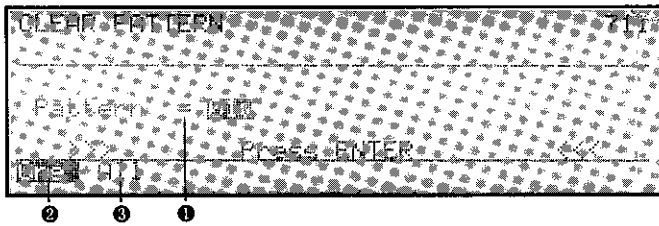

# UTILITY MODE

In utility mode you can make settings that affect the SY77's overall system, make settings for MIDI transmission and reception, transmit bulk data via MIDI, and save or load on card or disk.

<b>Contents of this section</b>	<b>page</b>
<b>System utility</b> .....	<b>217</b>
<b>MIDI utility</b> .....	<b>221</b>
<b>Card utility</b> .....	<b>225</b>
<b>Disk utility</b> .....	<b>227</b>

## UTILITY MODE

In Utility mode you can make settings that affect the SY77's overall system, make settings for MIDI transmission and reception, transmit bulk data via MIDI, and save or load data on card or disk. The functions of utility mode are divided into four job directories; System Utility, MIDI Utility, Card Utility, and Disk Utility. When you press UTILITY the last-selected of these directories will appear. Select a job directory by pressing F1-F4.

### System Utility job directory

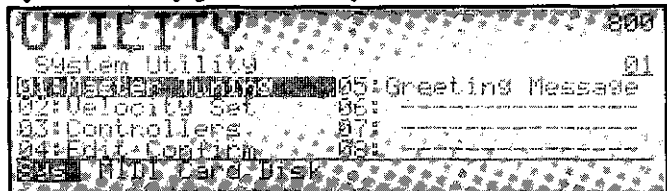

- 01: Master Tuning: The overall tuning of the SY77 can be adjusted both in half steps and fine tuning.
- 02: Velocity Set: The SY77 keyboard and internal tone generator can be set to respond to your playing velocity in various ways.
- 03: Controllers: The MODULATION 2 wheel and an optional footswitch connected to the FOOT SWITCH jack will transmit data using the MIDI control number you specify.
- 04: Edit Confirm: The "Are you sure?" message that appears when you store, recall, or initialize data can be turned on/off.
- 05: Greeting Message: Edit the two-line message that is briefly displayed when the SY77 power is turned on.

### MIDI Utility job directory

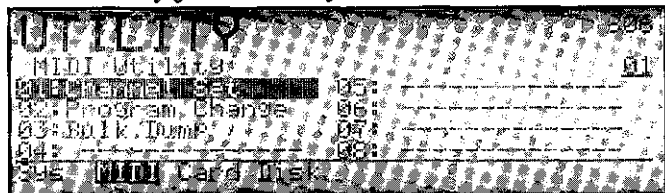

- 01: Channel Set: The SY77 will receive and transmit MIDI data as determined by the MIDI channels and settings specified here.

- 02: Program Change: MIDI program change messages will be received and transmitted as specified here.
- 03: Bulk Dump: Various types of SY77 data can be transmitted via MIDI to another SY77 or other device.

### Card Utility job directory

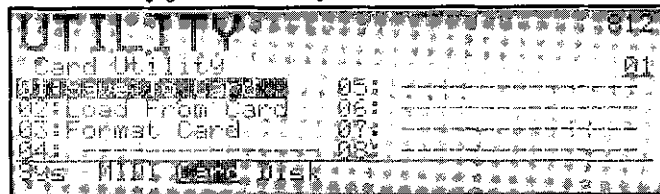

- 01: Save To Card: Synthesizer data can be saved to a RAM card.
- 02: Load From Card: Synthesizer data can be loaded from a RAM or ROM card.
- 03: Format Card: Before a RAM card can be used it must be formatted to accept SY77 data.

### Disk Utility job directory

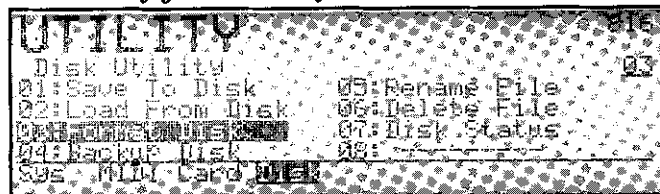

- 01: Save To Disk: Synthesizer or sequencer data can be saved to disk.
- 02: Load From Disk: Synthesizer or sequencer data can be loaded from disk.
- 03: Format Disk: Before a disk can be used it must be formatted to accept SY77 data.
- 04: Backup Disk: Use this operation to make backup disks for important data.
- 05: Rename File: An already existing disk file can be given a different name.
- 06: Delete File: An unwanted file can be deleted from disk.
- 07: Disk Status: This allows you to check the number of disk files and the remaining free area on the disk.



## System utility

JUMP #800

**Summary:** System utility settings affect the entire SY77 system.

**Procedure:**

From: MIDI Utility, Card Utility, or Disk Utility  
(JUMP #806, #812, #816)

Press: F1 (Sys) (JUMP #800)

Select: the desired system utility job and press ENTER.

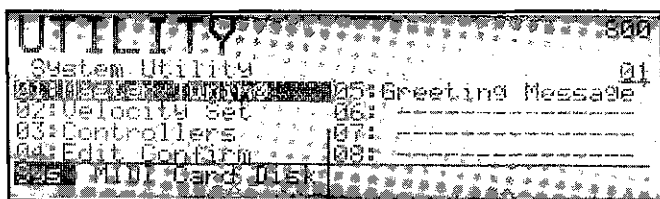

- ① Move the cursor in this area to select one of the following jobs and then press ENTER.

- 01: Master Tuning: The overall tuning of the SY77 can be adjusted both in half steps and fine tuning.
- 02: Velocity Set: The SY77 keyboard and internal tone generator can be set to respond to your playing velocity in various ways
- 03: Controllers: The MODULATION 2 wheel and an optional footswitch connected to the FOOT SWITCH jack will transmit data using the MIDI control number you specify.
- 04: Edit Confirm: The "Are you sure?" message that appears when you store, recall, or initialize data can be turned on/off.
- 05: Greeting Message: The two-line message that is briefly displayed when the SY77 power is turned on can be edited.

SYSTEM UTILITY

### 1. Master tuning

JUMP #801

**Summary:** The overall tuning of the SY77 can be adjusted both in half steps and fine tuning.

**Procedure:**

From: system utility job directory (JUMP #800)

Select: 01:Master Tuning (JUMP #801)

Specify: the overall tuning in half steps and fine steps

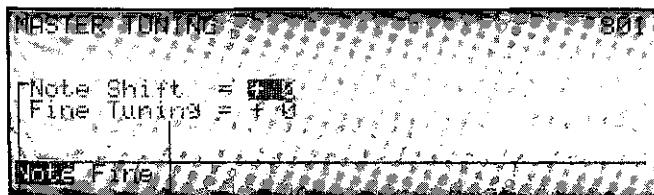

- ① Note Shift (-64...+63): This adjusts the pitch of the of the entire SY77 in half steps.
- ② Fine Tuning (-64...+63): This adjusts the pitch of the entire SY77 in steps of 1.171875 cents.

**Remarks:** To adjust the pitch of only specific voices, refer to *Voice Common job 2. Element Detune* and *3. Note Shift*.

This setting affects only the SY77's internal tone generator. It has no effect on the note numbers transmitted from MIDI OUT.

SYSTEM UTILITY

### 2. Velocity set

JUMP #802

**Summary:** The SY77 keyboard can be set to respond to your playing velocity in various ways.

**Procedure:**

From: system utility job directory (JUMP #800)

Select: 02:Velocity Set (JUMP #802)

Specify: the fixed velocity value and the velocity curve

# UTILITY MODE

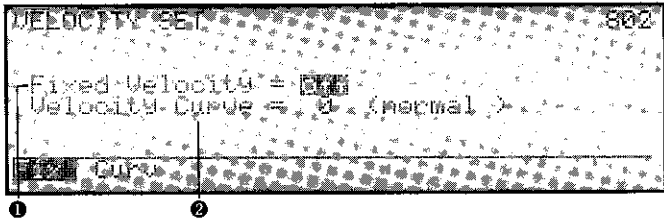

- ① Fixed Velocity (off, 1...127): When this is set "off", the SY77 tone generator will respond to your playing velocity according to the velocity curve specified in ②. When this is set to a value 0...127, all notes will be given the same specified velocity value regardless of your playing velocity.
- ② Velocity Curve (0...7): This determines the way in which the SY77 tone generator will respond to your playing velocity as shown in the following diagrams.

Velocity curves 6 (cross-1) and 7 (cross-2) allow you to crossfade between two voices using key velocity. Set one voice to positive key velocity sensitivity and the other to negative key velocity sensitivity. Refer to *AFM element data 5. AFM sensitivity (JUMP #243)* and *AWM element data 4. AWM sensitivity (JUMP #260)*.

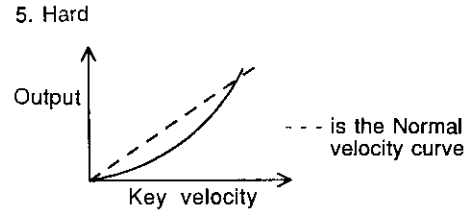
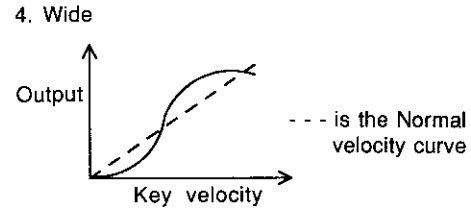
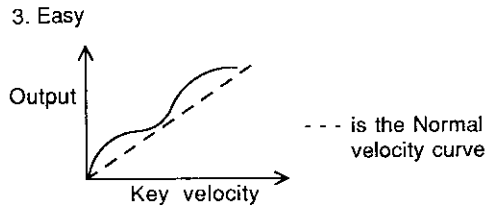

FIXED VELOCITY = 1~127

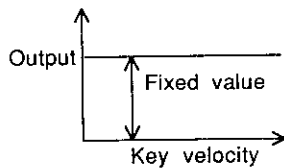

FIXED VELOCITY = Off

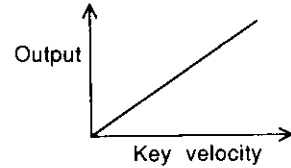

0. Normal

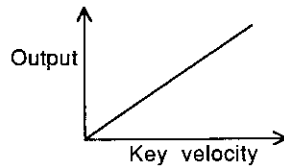

6. Cross - 1

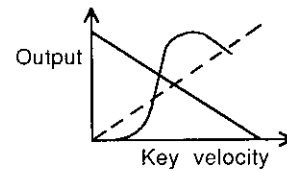

7. Cross - 2

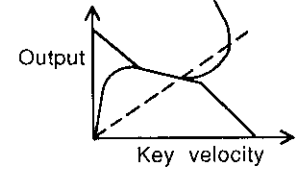

**Remarks:** When playing the sound of an instrument such as organ or harpsichord that normally does not respond to key velocity, it may be effective to use a fixed velocity value. A similar result could be achieved by setting all velocity sensitivity parameters of the voice to 0. In fact this is preferable since it will leave all other voices at their normal velocity settings.

The velocity curve setting affects only the SY77's internal tone generator, and will be effective for notes received from MIDI IN as well as notes played on the SY77 keyboard. This setting has no effect on the note messages transmitted from MIDI OUT.

1. Soft - 1

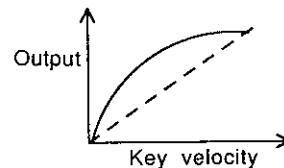

2. Soft - 2

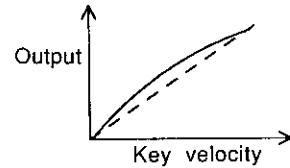

--- is the Normal velocity curve

### 3. Controllers

JUMP #803

**Summary:** The MODULATION 2 wheel and an optional footswitch connected to the FOOT SWITCH jack will transmit data using the MIDI control number you specify.

**Procedure:**

From: system utility job directory (JUMP #800)

Select: 03:Controllers (JUMP #803)

Specify: the MIDI control number for each assignable controller

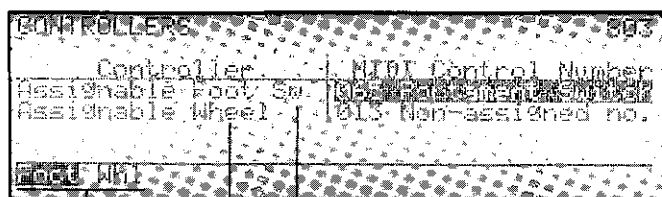

- ① Assignable Foot Switch (0...120): An optional foot switch connected to the rear panel FOOT SWITCH jack will transmit control messages of the type you specify here.
- ② Assignable Wheel (0..120): The MODULATION 2 wheel located at the left of the SY77 keyboard will transmit control messages of the type you specify here.
- ③ Press F1 (Foot) or F2 (Whl) to move the cursor to ① or ②.

**Remarks:** The settings in *Voice Common job 12. Controllers* (JUMP #226, #227, #228) determine the type of control message by which each parameter will be controlled. If you want to use an assignable controller to control the SY77's voices, make sure that the MIDI control number you assign matches the MIDI control number selected for the parameter you want to control.

If you want to assign the MODULATION 2 wheel or the FOOT SWITCH to control external MIDI equipment and not affect the SY77's tone generator, use a MIDI control number that is not used in *Voice Common job 12. Controllers* (JUMP #226, #227, #228). Refer to the MIDI implementation chart in the manuals for your other devices to learn how each device reacts to incoming MIDI control data. The official MIDI standard defines the use of the following control change messages. The control change messages listed in parenthesis in the following table (portamento time, sostenuto, etc.) do not correspond to functions of the SY77. They are listed for your convenience when using the SY77 to control other MIDI devices which have these functions.

Continuous type		On/off type	
001	Modulation wheel	064	Sustain
002	Breath controller	065	Portamento
004	Foot controller	066	(Sostenuto)
005	(Portamento time)	067	(Soft pedal)
006	Data entry	069	(Hold 2)
007	Main volume	091	(Ex effect depth)
008	Balance control	092	(Tremolo depth)
010	Panpot	093	(Chorus depth)
011	Expression	094	(Celeste depth)
		095	(Phaser depth)

## 4. Edit confirm

JUMP #804

**Summary:** The “Are you sure?” message that appears when you store, recall, or initialize data can be turned on/off.

**Procedure:**

From: system utility job directory (JUMP #800)

Select: 04:Edit Confirm (JUMP #804)

Specify: whether or not the confirm message will appear

- ❶ Edit Confirm (on, off): When this is on you will be asked “Are you sure?” whenever an operation that erases or replaces data is about to be performed. When this is off the operation will be executed without asking for confirmation.

**Remarks:** Until you are familiar with the SY77 we recommend that you leave this on.



## 5. Greeting message

JUMP #805

**Summary:** Edit the two-line message that is briefly displayed when the SY77 power is turned on.

**Procedure:**

From: system utility job directory (JUMP #800)

Select: 05:Greeting Message (JUMP #805)

Specify: the greeting message

- ❶ Enter the two-line x 20 character greeting message.
- ❷ To clear the currently entered message press F1 (Clr). To switch to upper-case characters press F2 (Uppr). To switch to lower-case characters press F3 (Lowr).

**Remarks:** Methods of entering character data are explained in *How to enter data* of *Introducing the SY77*.

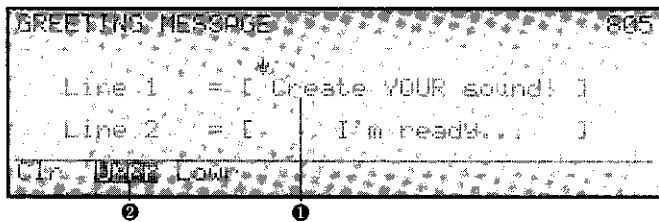

## MIDI utility

JUMP #806

**Summary:** MIDI utility settings determine how MIDI data is transmitted and received.

**Procedure:**

From: System Utility, Card Utility, or Disk Utility (JUMP #800, #812, #816)

Press: F2 (MIDI) (JUMP #806)

Select: the desired MIDI utility job and press ENTER.

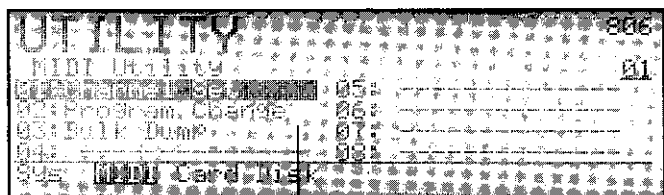

- ① Move the cursor in this area to select one of the following jobs and then press ENTER.

01: Channel Set: The SY77 will receive and transmit MIDI data as determined by the MIDI channels and settings specified here.

02: Program Change: MIDI program change messages will be received and transmitted as specified here.

03: Bulk Dump: Various types of SY77 data can be transmitted via MIDI to another SY77 or other device.

MIDI UTILITY

## 1. Channel set

JUMP #807

**Summary:** The SY77 will receive and transmit MIDI data as determined by the MIDI channels and settings specified here.

**Procedure:**

From: MIDI utility job directory (JUMP #806)

Select: 01:Channel Set (JUMP #807)

Specify: MIDI transmit and receive channels and settings

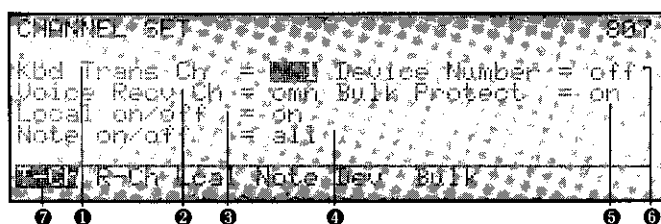

① Keyboard Transmit Channel (1...16): This determines the channel on which data will be transmitted from MIDI OUT when you play the keyboard or move the various controllers. In multi mode, this also determines which of the sixteen voices will be played by the keyboard.

② Voice Receive Channel (1...16, omni): This determines the channel on which the SY77 can be played when in voice play mode. When "omni" is selected the SY77 will respond to any channel. In multi play mode, program changes received on this channel will select multis.

- ③ Local on/off (off, on): This determines whether or not the SY77 keyboard will play the SY77 tone generator. Usually you will leave this on so that the SY77 keyboard will play the SY77 tone generator.

When set off the SY77 tone generator will produce sound only in response to messages from MIDI IN, but messages will be transmitted from MIDI OUT when you play the keyboard or move the various controllers.

- ④ Note on/off (all, odd, even): When set to "all" the SY77 tone generator will produce sound in response to all notes received at MIDI IN. When set to "odd" or "even", the SY77 tone generator will respond only to odd or even notes. This affects only the notes received at MIDI IN, and will have no effect on the notes played by the SY77 keyboard.

- ⑤ Device Number (off, 1...16, all): This determines the channel on which the SY77 will receive MIDI system exclusive messages such as parameter changes and bulk data. When off is selected system exclusive messages will not be received. When "all" is selected system exclusive messages will be received on any channel 1...16.

## UTILITY MODE

- ⑥ Bulk Protect (off, on): The SY77 is able to receive system exclusive bulk data at any time, and the newly received data will replace the data in memory. By setting bulk protect on you can prevent unexpectedly arriving bulk data from overwriting important data.
- ⑦ Pressing F1–F6 will move the cursor to the corresponding item in the display.

**Local:** If you are using the SY77 by itself, you should usually leave local on. However local off can be useful in the following situations.

Some commercially available MIDI processing devices are able to receive a stream of MIDI note and controller data and process it to create parallel harmony or other musical effects. If you have this type of MIDI processing unit, it may be interesting to set the SY77 local off and make MIDI connections so that the note and controller data transmitted from the SY77's MIDI OUT is processed by the MIDI processing unit and then transmitted back to the SY77's MIDI IN.

If you use an external sequencer with the SY77, you will probably record from the SY77's MIDI OUT to the sequencer, and playback from the sequencer's MIDI OUT to the SY77's MIDI IN. If the external sequencer is able to echo back (retransmit) the data being recorded, you can turn local off for the SY77 so that it produces sound only in response to data from the external sequencer.

**Note on/off:** This setting can be used to increase the number of simultaneous notes. Each SY77 is able to produce up to 16 notes of AFM sound and 16 notes of AWM sound at once. By sending the same MIDI data to two SY77s and setting one to note "odd" and the other to note "even", you can double the number of simultaneous notes that can be produced.

MIDI UTILITY

## 2. Program change

JUMP #808

**Summary:** MIDI program change messages will be received and transmitted as specified here.

**Procedure:**

- From: MIDI utility job directory (JUMP #806)
- Select: 02:Program Change (JUMP #808)
- Specify: how program changes will be received and transmitted

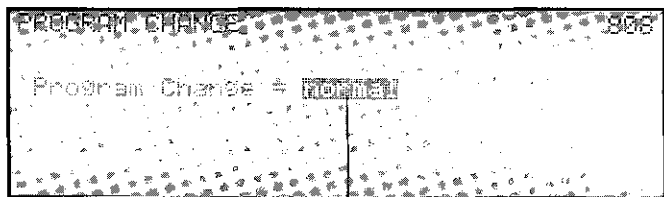

- ① Program Change (off, normal, direct): This determines what the SY77 does when a program change message is received at MIDI IN, and how program change messages are transmitted from MIDI OUT. Usually you will leave this set at "normal". If you wish to use program change messages to select memories, set this to "direct".

**Program Change = off:** Incoming program change messages will be ignored. Program change messages will not be transmitted.

**Program Change = normal:** When in voice mode, incoming program changes 0–63 will select voices 1–64. Program changes 64–127 will be ignored. Regardless of the memory (internal, card, preset 1 or preset 2) that is selected, a MIDI program change 0–63 will be transmitted when you select a voice 1–64.

When in multi mode, incoming program changes 0–63 will select voices 1–64 for the corresponding channel of the multi. Program changes 64–79 on the voice receive channel will select multis 1–16. Program changes 80–127 will be ignored. Regardless of the memory (internal, card, preset 1 or preset 2) that is selected, a MIDI program change 0–63 will be transmitted when you select a voice 1–64. A program change 64–79 will be transmitted when you select a multi 1–16.

**Program change = direct:** This allows any voice or multi memory to be selected using program changes. Program changes 0–116 will be received and transmitted just as in “normal”.

- **Transmission:** If you select a voice or multi after changing the memory (internal, card, preset 1, or preset 2) or mode (voice or multi), one of the following program changes 117–127 will be transmitted to indicate the newly selected memory or mode. Immediately following this will be the program change of 0–63 or 64–79 to indicate the newly selected voice or multi.
- **Reception:** Incoming program changes 117–124 will select a voice memory, and must be immediately followed by a program change 0–63 to select the voice number. Incoming program changes 125–127 will select a multi memory, and must be immediately followed by a program change 64–79 to select the multi number.

Incoming program changes 119 and 120 are not distinguished, since a internal multi is not allowed to use card voices, nor vice versa.

No.	Mode	Type	Memory
117	Voice mode	Voice	Preset 2
118	Multi mode	Voice	Preset 2
119	Multi mode	Voice	Internal
120	Multi mode	Voice	Card
121	Multi mode	Voice	Preset 1
122	Voice mode	Voice	Internal
123	Voice mode	Voice	Card
124	Voice mode	Voice	Preset 1
125	Multi mode	Multi	Internal
126	Multi mode	Multi	Card
127	Multi mode	Multi	Preset

MIDI UTILITY **3 Bulk dump** **JUMP #809**

**Summary:** Various types of SY77 data can be transmitted via MIDI to another SY77 or other device.

**Procedure:**

- From: MIDI utility job (JUMP #806) directory
- Select: 03: Bulk Dump (JUMP #809)
- Specify: the type of data to be transmitted
- To execute: data transmission press F8 (Go).
- To quit: without executing press EXIT.

- 01: Vc & Mlt: All internal voice, multi, pan, and micro tuning data
- 02: Syn Setup: System setup data for the synthesizer section
- 03: Pan: All internal pan data
- 04: McrTuning: All internal micro tuning data
- 05: 64 voices: All internal voices
- 06: 16 Multis: All internal multis
- 07: 1 Voice: A single specified voice
- 08: 1 Multi: A single specified multi
- 09: Seq All: All data of the sequencer section
- 10: Song&Ptn: Song and pattern data
- 11: Seq Setup: Setup data of the sequencer section
- 12: NSEQ: Sequencer data in N-Seq format

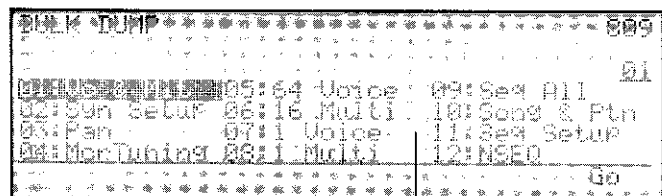

- ① Move the cursor in the area to select the type of data you wish to transmit. Then press F8 (Go).

**Go:** When you press F8 (Go) transmission will begin and the bottom line of the LCD will display “Now transmitting !” When transmission ends the bottom line will display “Complete !”

## UTILITY MODE

**1 Voice:** If you select 07:1 Voice and press F8 (Dir) a directory of the sixteen voices in the currently selected bank will appear. Select a bank A–D, and select a voice 1–16. Then press F8 (Go) and the data of the selected voice will be transmitted. Only internal voices can be dumped.

**1 Multi:** If you select 08:1 Multi and press F8 (Dir) a directory of the sixteen multis in the currently selected memory will appear. Select a multi 1–16. Then press F8 (Go) and the data of the selected multi will be transmitted. Only internal multis can be dumped.

**Remarks:** For the data to be received by another SY77, the device number settings of the two units must match.

Data transmitted by 07:1 Voice or 08:1 Multi will be received into the editing buffer of the receiving device. If you select another memory before storing it into a memory, the newly received data will be lost.



## Card utility

JUMP #812

**Summary:** Card utility jobs allow you to transfer data to and from a card, and to format a card to accept SY77 data.

**Procedure:**

From: System Utility, MIDI Utility, or Disk Utility (JUMP #800, #806, #816)

Press: F3 (Card) (JUMP #812)

Select: the desired card utility job and press ENTER.

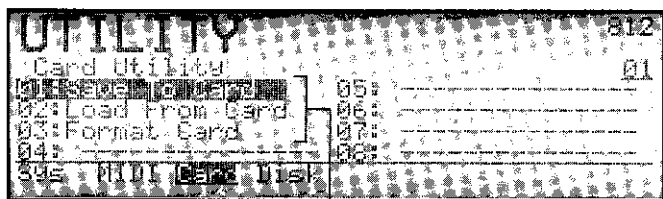

① Move the cursor in this area to select one of the following jobs and then press ENTER.

01: Save To Card: Synthesizer data can be saved to a RAM card.

02: Load From Card: Synthesizer data can be loaded from a RAM or ROM card.

03: Card Format: Before you use a new RAM card, you must use this operation to format it so that the card can be used by the SY77.

### CARD UTILITY

## 1. Save to card

JUMP #813

**Summary:** Synthesizer data can be saved to a RAM card.

**Procedure:**

From: card utility job directory (JUMP #812)

Select: 01: Save To Card (JUMP #813)

To execute: the operation press F8 (Go).

To quit: without executing press EXIT.

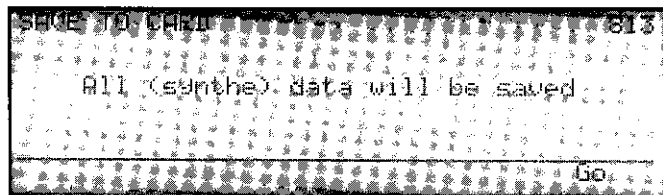

Press F8 (Go) to save the synthesizer data to card. The display will ask "Are you sure?" so if you are sure you want to save the data press YES.

If the card inserted in the DATA card slot has not been formatted for the SY77 the LCD will show "Warning: Format Error !" Press EXIT to exit from the error message.

This function saves the following data to RAM card.

- Setup data (system data, pan data, micro tuning data)
- Internal voices 1-64
- Internal multis 1-16

This job saves all synthesizer data to a RAM card inserted in the DATA card slot. Before a newly purchased RAM card can be used by the SY77 it must be formatted using the 3. *Format card* function explained later in this section.

## 2. Load from card

JUMP #814

**Summary:** Synthesizer data can be loaded from a RAM or ROM card.

**Procedure:**

From: card utility job directory (JUMP #812)

Select: 02:Load From Card (JUMP #814)

Specify: the type of data to be loaded.

To execute: the load operation press F8 (Go).

To quit: without executing press EXIT.

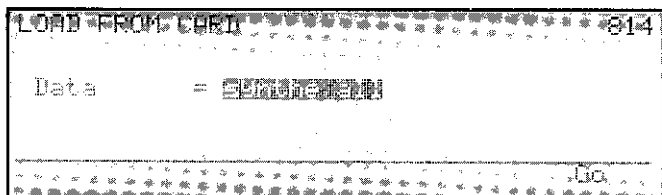

- ① Data Type (synth all, multi&voice (pan, mct), synth setup): You can load all or part of the data from card. When “synth all” is selected all the data will be loaded. When “multi&voice (pan, mct)” is selected multi, voice, pan, and micro-tuning data will be loaded. When “synth setup” is selected the system data will be loaded.

This function loads the specified type of synthesizer data from a RAM or ROM card inserted in the DATA card slot. After selecting the data type to load, press F8 (Go) to load the data from card. The display will ask “Are you sure?” so if you are sure you want to load the data press YES.

If the card inserted in the DATA card slot has not been formatted for the SY77 the LCD will show “Warning: Format Error !” Press EXIT to exit from the error message.

## 3. Format card

JUMP #815

**Summary:** Before you use a new RAM card, you must format it so that the card can be used by the SY77.

**Procedure:**

From: card utility job directory (JUMP #812)

Select: 03:Card Format (JUMP #815)

To execute: the operation press F8 (Go).

To quit: without executing press EXIT.

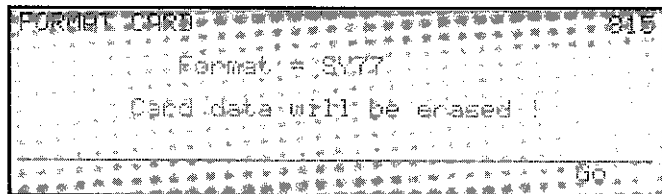

This function prepares a MCD64 RAM card (sold separately) for use by the SY77.

Insert the card into the DATA card slot and press F8 (Go). The display will ask “Are you sure?” so if you are sure you want to format the card press YES.

If the card is a type that cannot be used by the SY77 or if it is faulty the LCD will show an error message. Press EXIT to exit from the error message.

## Disk utility

JUMP #816

**Summary:** Disk utility operations allow you to transfer data to and from a disk, and to format a disk to accept SY77 data.

**Procedure:**

From: System Utility, MIDI Utility, or Card Utility (JUMP #800, #806, #812)

Press: F4 (Disk) (JUMP #816)

Select: the desired disk utility job and press ENTER

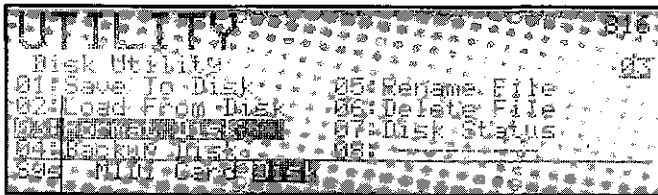

- ① Move the cursor in this area to select one of the following jobs and then press ENTER.  
01: Save To Disk: Synthesizer or sequencer data can be saved to disk.

02: Load From Disk: Synthesizer or sequencer data can be loaded from disk.

03: Format Disk: Before a disk can be used it must be formatted to accept SY77 data.

04: Backup Disk: Use this operation to make backup disks for important data.

05: Rename File: An already existing disk file can be given a different name.

06: Delete File: An unwanted file can be deleted from disk.

07: Disk Status: This allows you to check the number of disk files and the remaining free area on the disk.

**Important:** Before using a newly purchased disk or a disk that has been used by other devices, you must format the disk using the 03:Disk Format command.

### DISK UTILITY

## 1. Save to disk

**Summary:** Synthesizer and sequencer data can be saved to disk.

**Procedure:**

From: disk utility job directory (JUMP #816)

Select: 01:Save To Disk and press ENTER

Specify: the type of data to be saved.

Press: ENTER

Specify: the file into which the data will be saved

To execute: the operation press F8 (Go).

To quit: without executing press EXIT.

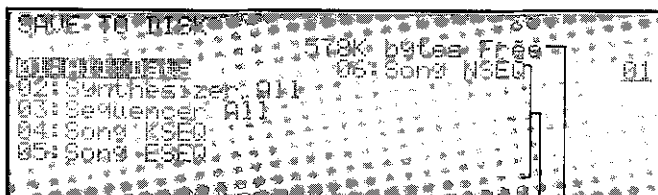

- ① This shows the amount of free area remaining on the disk inserted in the disk drive.
- ② Move the cursor in this area to select the type of

data you wish to save to disk and then press ENTER

01: All Data: All data of the SY77

02: Synthesizer All: All data of the synthesizer section

03: Sequencer All: All data of the sequencer section

04: Song KSEQ: Sequencer song data in K-Seq format (SY77 sequence data format without the setup data)

05: Song ESEQ: Sequencer song data in E-Seq format (Yamaha QX3, electones, player pianos, etc.)

06: Song NSEQ: Sequencer song data in N-Seq format (Yamaha V50, QX5FD, etc.)

**E-Seq and N-Seq:** The SY77 can save its sequence data in E-Seq or N-Seq format, and this data can be loaded into other Yamaha sequencers. However, data which the other device is not able to use will be ignored.

## UTILITY MODE

1. Move the cursor to the type of data you wish to save and then press ENTER to get the following display.

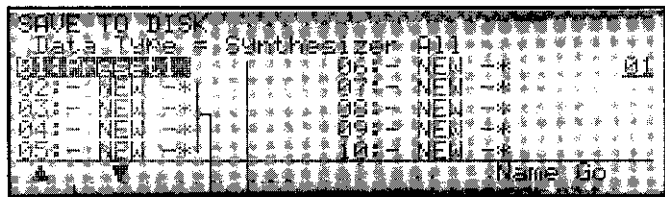

- 1 This indicates the type of data you selected in the previous display.
- 2 This area will display the names of all disk files of the type you selected. Move the cursor in this area or use the numeric keys to select a disk file 1-99 to which the data will be saved. Unused files are indicated by a "\*" mark. If you save the data without changing the name, the "\*" will disappear.
- 3 The LCD can show only ten filenames at once. To see the rest of the filenames press F1 (▲) or F2 (▼) to scroll the filename display up or down.
- 4 If you want to change the name of the selected file then press F7 (Name) and you will enter the job explained in the following section *1.1 Save to disk filename*.

- 5 If you want to save the data to the selected file without modifying the name, press F8 (Go).
2. Data is stored on disk in *files*. Move the cursor to select a disk file to which the selected data will be saved.
3. To save the data from SY77 memory to the selected file, press F8 (Go).
4. If data already exists in the selected file, the bottom line of the display will ask "Overwrite ? (Yes or No)". If you do not need to keep the old data in the file then press YES and the old data will be overwritten. If the old data is important then press NO and select a different file.

**Filename:** Since the SY77 recognizes each disk file by its *number* not by its *filename* it is possible for two or more files to be given the same name. However it is a good idea to name each file as a reminder of the contents.

### DISK UTILITY

## 1.1 Save to disk filename

**Summary:** Each file on disk can be given an eight-character name as a reminder of the contents.

**Procedure:**

From: the *Save to disk* filename job in *1. Save to disk*

Press: F7 (Name)

Specify: an 8-character filename.

To execute: the *Save To Disk* operation press F8 (Go).

To quit: without executing press EXIT.

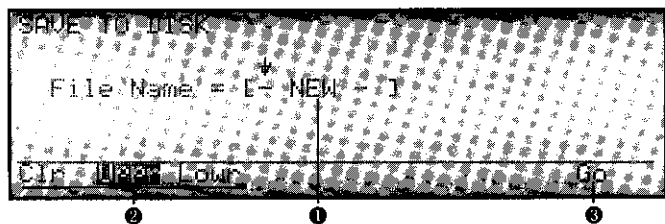

- 1 Enter an eight-character name for the file.
- 2 To clear the currently entered name press F1 (Clr). To switch to upper-case characters press F2 (Uppr). To switch to lower-case characters press F3 (Lowr).
- 3 After entering a name for the disk file press F8 (Go). The bottom line of the display will ask "Are you sure ?" If you are sure that you want to save the data then press YES and the data will be saved to the specified disk file.

**Remarks:** Methods of entering character data are explained in *How to enter data* of the *Introductory* manual.

Note that the actual disk save operation can be executed either from this *1.1 Save to disk filename* job or from the *1. Save to disk* job.

## 2. Load from disk

JUMP #817

**Summary:** Synthesizer and sequencer data can be loaded from disk.

**Procedure:**

From: disk utility job directory (JUMP #816)

Select: 02:Load From Disk (JUMP #817)

Specify: the type of data to be loaded.

Press: ENTER

Select: the file from which to load the data.

To execute: the loading operation press F8 (Go).

To quit: without loading press EXIT.

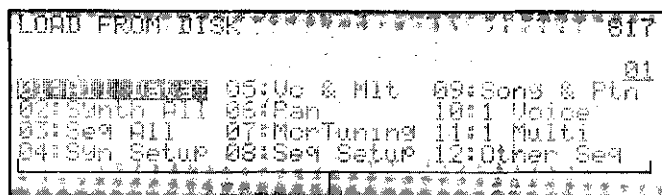

① Move the cursor in this area to select the type of data you wish to load from disk.

01: All Data: All data of the SY77

02: Synth All: 64 voices, 64 multis, 32 pan, 2 micro tuning, and system setup

03: Seq All: K-Seq data and setup data of the sequencer section

04: Syn Setup: Synthesizer system setup data from a disk file that was saved as "All Data"

05: Vc & Mlt: 64 voices, 64 multis, 32 pan, and 2 micro tuning data from a disk file that was saved as "All Data"

06: Pan: 32 pan data from a disk file that was saved as "All Data"

07: McrTuning: 2 micro tuning data from a disk file that was saved as "All Data"

08: Seq Setup: Setup data of the sequencer section

09: Song & Ptn: Song and pattern data of the sequencer section

10: 1 Voice: A single selected voice from a disk file that was saved as "All Data"

11: 1 Multi: A single selected multi from a disk file that was saved as "All Data"

12: Other Seq: Sequencer data in K-Seq, E-Seq, or N-Seq format

The data that can be loaded will depend on the type of data that was saved in *1. Save to disk*.

Data that was saved by 1. Save to disk ...	... can be loaded by 2. Load from disk
1.All Data	Any type of data 1, 4-11
2.Synthesizer All	2.Synth All
3.Sequencer All	3.Seq All
4.KSEQ, 5. ESQ, 6. NSEQ	12.Other Sequence

Individual types of data 4-11 can be loaded only from a file saved as "All Data".

After selecting the desired type of data, press ENTER to select the disk file from which to load the data.

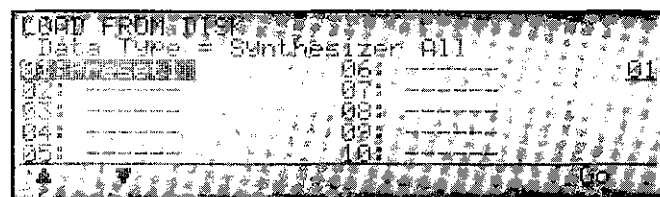

- The names of all disk files of the selected type will be displayed. Files that contain no data are displayed as "-----". Move the cursor in this area to select a file 1-99. You may also use the numeric keys to directly specify a file number.
- The LCD can show only ten filenames at once. To see the rest of the filenames press F1 (Δ) or F2 (∇) to scroll the filename display up or down.

**Load from disk (types 1-9):** After selecting a file press F8 (Go). The display will ask "Are you sure?" If you are sure that you want to load the data then press YES and the data will be loaded from disk file into the SY77.

**Load from disk (types 10, 11):** Selecting data types *10. 1 Voice* or *11. 1 Multi* allows you to load a single specified voice (or multi) from a disk file that was saved as "All Data". The procedure is exactly the same for voices and multis.

1. After selecting a file press F8 (Dir) to view a list of the voices (multis) in the selected file.
2. The display will show ten voices (multis) at once. Use F3 (Δ) and F4 (∇) to scroll the display up or down, and move the cursor to select the desired voice (multi).

## UTILITY MODE

3. To select the destination into which the selected voice (multi) will be loaded, press F2 (Dst) the bank A–D (only when loading voices), and the memory select buttons 1–16 to specify the loading destination. Voice saved from bank A–C can be loaded only into bank A–C.
4. When you have selected the destination voice (multi), press F8 (Go) and the selected voice (multi) will be loaded from disk into internal memory.

### Load from disk (type 12): Selecting data type 12.

*Other sequence* allows you to load sequence data that was saved in E-Seq or N-Seq format into the SY77 sequencer. This allows you to load sequence data into the SY77 sequencer from a disk that was saved by another Yamaha device.

1. When data type 12. *Other sequence* is selected, the display will show *all* files on the disk, whether or not they were created by the SY77.

The three character extension of each filename is also displayed. “K” indicates K-Seq data, “E” indicates E-Seq data, and “N” indicates N-Seq data. Files that contain no data are displayed as “----”. Move the cursor in this area to select a file.

2. The LCD can show only ten filenames at once. To see the rest of the filenames press F1 (Δ) or F2 (∇) to scroll the filename display up or down.
3. After selecting a file which contains sequence data, press F8 (Go) to load the file into the SY77’s sequencer memory. If you select and attempt to load a file which does not contain sequencer data readable by the SY77, an error message will be displayed.

When loading E-Seq or N-Seq data, any data specific to the device which created the file will be ignored. For example when loading N-Seq data saved by the QX5FD, macro data will be ignored, and when loading K-Seq data saved by the V50 sequencer only song 1 will be loaded.

DISK UTILITY

## 3. Format disk

JUMP #818

**Summary:** Before a disk can be used it must be formatted to accept SY77 data.

**Procedure:**

From: disk utility job directory (JUMP #816)

Select: 03:Disk Format (JUMP #818)

To execute: the formatting operation press F8 (Go).

To quit: without executing press EXIT.



Newly purchased disks must be formatted by the SY77 before they can be used to store data. *Formatting a disk will erase all the data on the disk.* Be careful not to accidentally format a disk which contains valuable data.

The display will ask you to “Please insert a blank disk”. Make sure that the write protect slider of the disk is in the write enabled position with the slider covering the hold, insert the disk into the disk drive, and press F8 (Go). You will be asked “Are you sure?” If you are sure you want to format the disk press YES and formatting will begin.

While the disk is being formatted the display will show “xx% Formatted”. When the number reaches 100% the display will show “Completed!” until a switch is pressed.

DISK UTILITY

## 4. Backup disk

JUMP #819

**Summary:** Use this operation to make backup disks for important data.

**Procedure:**

From: disk utility job directory (JUMP #816)

Select: 04:Back Up Disk (JUMP #819)

To execute: the backup operation press F8 (Go).

To quit: without executing press EXIT.

Floppy disks are generally quite reliable, but it is always a good idea to make backup copies of important data.

**Important:** When this 4. Backup disk operation is used, all data in the SY77 sequencer memory will be lost.

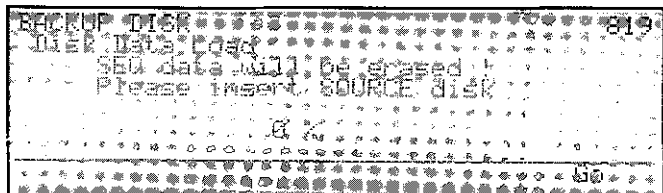

1. Insert the source disk (the original data) into the disk drive and press F8 (Go). The display will show "Now Loading" and the data will be loaded into the SY77's memory. The "xx% Loaded" display indicates the percentage of the backup data that has been loaded.
2. When the SY77 has loaded as much data as possible, the display will ask you to "Please insert DUPLICATE into drive."
3. Make sure that the backup disk is correctly formatted for the SY77 and that its write protect slider is in the write enabled position (covering the hole). Insert the backup disk into the disk drive and press F8 (Go).
4. The display will show "Now Saving" and the data will be saved onto the backup disk. The "xx% Saved" display indicates the percentage of the data that has been saved.
5. Repeat steps 1–4 until 100% of the source data has been loaded and saved. When the backup process is complete the display will show "Completed!".

DISK UTILITY

## 5. Rename file

**Summary:** An already existing disk file can be given a different name.

**Procedure:**

From: disk utility job directory (JUMP #816)

Select: 05:Rename File

Specify: the type of file you wish to rename.

Press: ENTER

Specify: the file you wish to rename.

Press: ENTER

Specify: the new filename.

To execute: the rename operation press F8 (Go).

To quit: without executing press EXIT.

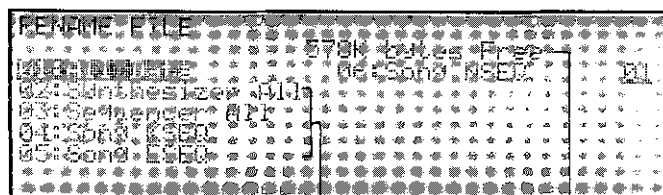

- ① This shows the amount of remaining free memory for the currently inserted disk.
- ② Move the cursor in this area to select the type of file you wish to rename.
  - 01: All Data: All data of the SY77
  - 02: Synthesizer All: All data of the synthesizer section
  - 03: Sequencer All: All data of the sequencer section
  - 04: Song KSEQ: Sequencer song data in K-Seq format (SY77 sequence data format without the setup data)
  - 05: Song ESEQ: Sequencer song data in E-Seq format (Yamaha QX3, electones, player pianos, etc.)
  - 06: Song NSEQ: Sequencer song data in N-Seq format (Yamaha V50, QX5FD, etc.)

## UTILITY MODE

1. After selecting the type of file you wish to rename, press ENTER and the names of all files of the selected type will be displayed.
2. Move the cursor or use the numeric keys to select the file 1-99 you wish to rename. If necessary press F1 (Δ) or F2 (∇) to scroll the list of filenames.
3. After selecting the file you wish to rename press F8 (Name).
4. Enter an eight-character name for the file. To

clear the currently entered name press F1 (Clr). To switch to upper-case characters press F2 (Uppr). To switch to lower-case characters press F3 (Lowr).

5. After entering a new name for the disk file press F8 (Go). The bottom line of the display will ask "Are you sure ?" If you are sure that you want to rename the file then press YES and the disk file will be renamed.

DISK UTILITY

## 6. Delete file

**Summary:** You can delete an unwanted file from disk.

**Procedure:**

From: disk utility job directory (JUMP #816)

Select: 06:Delete File

Specify: the type of file you wish to delete.

Press: ENTER

Specify: the file you wish to delete.

To execute: the delete file operation press F8 (Go).

To quit: without executing press EXIT.

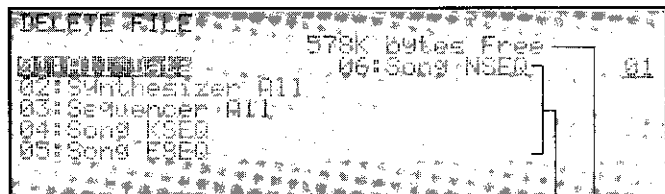

- 1 This shows the amount of remaining free memory for the currently inserted disk.
- 2 Move the cursor in this area to select the type of file you wish to delete.  
01: All Data: All data of the SY77  
02: Synthesizer All: All data of the synthesizer section

03: Sequencer All: All data of the sequencer section

04: Song KSEQ: Sequencer song data in K-Seq format (SY77 sequence data format without the setup data)

05: Song ESEQ: Sequencer song data in E-Seq format (Yamaha QX3, electones, player pianos, etc.)

06: Song NSEQ: Sequencer song data in N-Seq format (Yamaha V50, QX5FD, etc.)

1. After selecting the type of file you wish to delete, press ENTER and the names of all files of the selected type will be displayed.
2. Move the cursor or use the numeric keys to select the file 1-99 you wish to delete. If necessary press F1 (Δ) or F2 (∇) to scroll the list of filenames.
3. After selecting the file you wish to delete press F8 (Go). The bottom line of the display will ask "Are you sure ?" If you are sure that you want to delete the file then press YES and the disk file will be deleted.

DISK UTILITY

## 7. Disk status

**Summary:** You can check the number of disk files and the remaining free area on the disk.

**Procedure:**

From: disk utility job directory (JUMP #816)

When: the disk you want to check is inserted

Select: 07:Disk Status

To exit: the disk status display press EXIT.

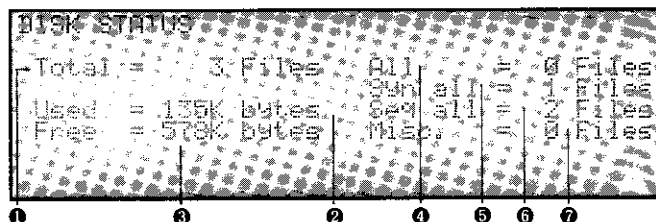



- ① Total: The total number of files on the disk
- ② Used: The amount of disk space occupied by files
- ③ Free: The amount of unused disk space
- ④ All: The number of files saved as "All Data".
- ⑤ Syn all: The number of files saved as "Synthesizer All".
- ⑥ Seq all: The number of files saved as "Sequencer All".
- ⑦ Misc.: The number of all other types of files.

**Remarks:** When this job is selected the currently inserted disk will be checked immediately, so be sure to insert the disk before you select the job. There are no settings to make in this job.





**APPENDIX**



# APPENDIX

This section contains various supplementary information that may be useful to advanced users or programmers.

<b>Contents of this section</b>	<b>page</b>
<b>Explanation of the preset voices .....</b>	<b>238</b>
<b>Using RCM hybrid synthesis .....</b>	<b>242</b>
<b>Error messages .....</b>	<b>244</b>
<b>Multi data blank chart.....</b>	<b>247</b>
<b>Specifications .....</b>	<b>248</b>
<b>Index.....</b>	<b>249</b>

## Explanation of the preset voices

### Preset 1

- A-1 GrandPiano: Standard grand piano.
- A-2 Arianne: Warm synth and sample hybrid pad. MW1 = vibrato.
- A-3 Dyno E.Pno: A pretty tine piano, very expressive and most suitable for solo improvisation. MW1 = vibrato, aftertouch = tremolo.
- A-4 Alto Sax: Bright alto sax with a wide dynamic range.
- A-5 BrasChoral: Very expressive “piano style brass” which expands into full brass with a heavy touch. Aftertouch = vibrato.
- A-6 Folk 1 Gtr: Steel string folk guitar.
- A-7 Triton: Synth sound using sharp digital filters, suggesting a satellite observed from the spacecraft Voyager.
- A-8 FrenchHorn: Standard orchestral horn. Aftertouch = vibrato, MW2 = panning.
- A-9 MW2TackPno: Tack piano, simulating the rinky tink sound of a piano with thumbtacks stuck into the hammers. MW2 = tone
- A-10 Wood Bass: Plucked upright bass. Raise MW1 to the maximum position for a pulling-off effect. Aftertouch = vibrato.
- A-11 ChamberStr: Violin quartet. Aftertouch = vibrato.
- A-12 Jazz Organ: Electric organ with fast rotary speaker.
- A-13 Nasty Saw: Bright, fat analog synth. MW1 adds vibrato, MW2 = brightness.
- A-14 Metamonics: Similar to electric guitar harmonics, nice for broad arpeggios.
- A-15 Itopia: Rich, chorused synth choir. Velocity and MW2 dynamically control brightness over a wide range. MW1 = vibrato.
- A-16 Wild Sing: Chords must be sustained to hear this sitar-like instrument get into its rhythm. Aftertouch = pitch bend, MW1 = vibrato.
- B-1 Dyna Grand: Acoustic piano with a broad dynamic range.
- B-2 MW2Grand: Full bodied piano with a resonant cabinet quality in the bass register. MW2 = timbre from dark to bright.
- B-3 8ba Piano: A bright double piano in a low octave. Play hard sustained rock chords with a heavy bass. Aftertouch = chorus.
- B-4 Rock Pno: Rock piano, good for powerful chord backing.
- B-5 Chorus Pno: Chorused CP70-type electric piano.
- B-6 BigChordEP: Microtuning scales this mix of electric and acoustic pianos so that the E.Piano moves from above to below the octave of the acoustic piano according to the pitch region.
- B-7 Ice Piano: Synth piano, good for slow songs.
- B-8 Dark E.Pno: A dark fat comping electric piano.
- B-9 Wet Clavi: A long sustaining, heavy bass clavinet. Aftertouch = vibrato.
- B-10 TightClavi: Slightly fatter sound than B09 and with a shorter decay, good for rhythmical backing.
- B-11 Celesta: MW 1 adds a slow rolling chorus effect to this standard celesta.
- B-12 Harpsichrd: A mixed harpsichord of two registers.
- B-13 Full Organ: A full organ which can be heard in any loud band. Aftertouch = vibrato.
- B-14 Pipe Organ: Classical pipe organ. MW1 = 16' pipe volume, MW2 = brightness in the upper ranks.
- B-15 Solo Trmpt: Tight solo trumpet.
- B-16 DualTrmpt: Dual solo trumpets; one left and one right. Aftertouch = vibrato.
- C-1 Mute Trmpt: Muted trumpet sound. Aftertouch = vibrato.
- C-2 FlugelHorn: Dynamic flugelhorn. Aftertouch = vibrato, and MW2 dynamically = timbre from mellow to bright.
- C-3 Big Band: A breathy light touchy, screaming heavy touchy big band. Aftertouch = vibrato.

- C-4 Brass1 Sct: Bright brass trumpet section.
- C-5 1980 Brass: Analog synth brass sound popular from the end of the 70's through the beginning of the 80's. Also good for powerful leads.
- C-6 Star Brass: Synthetic analog style brass sound. Aftertouch = vibrato.
- C-7 Anna Brass: Analog synth brass with broad dynamic range by velocity.
- C-8 BrashBrass: Powerful brass sound that will not be overpowered by any rock band.
- C-9 Soft Brass: Soft synth brass.
- C-10 DigiSwpBrS: AWM brass waveform swept by a digital filter.
- C-11 Brass2 Sct: Analog brass section.
- C-12 Soft Sax: A warmer sax sound. Aftertouch = vibrato.
- C-13 Tenor Sax: Normal tenor sax.
- C-14 Flute: Warm and classical flute. Aftertouch = vibrato.
- C-15 Clarinet: Clarinet, responsive to key velocity.
- C-16 Reed Piper: A "general purpose" double reed instrument. Aftertouch = vibrato.
- D-1 Tutti Orch: Orchestra sound, mainly strings. Play strongly to add timpani.
- D-2 Trad E.Pno: Warm, rich electric piano. MW1 = stereo tremolo, MW2 = panning.
- D-3 Full E.Pno: Electric piano, good for ballads.
- D-4 Bop Organ: Percussive organ.
- D-5 Warm Organ: Electric organ for pop or rock.
- D-6 Deep Organ: Bright organ, good for rock backing.
- D-7 Pan Flute: Breathly, husky pan flute
- D-8 MW2Feedbck: Bright distortion lead guitar sound. MW1 = vibrato. MW2 acts as a dynamic timbre control. At the low position the sound the sound is full and thick. At the middle position the tone is less distorted and warmer in the treble register. At the high position, the bass register become fuzz guitar and the treble register above G3 becomes harmonic feedback.
- D-9 Distort5th: Distorted guitar in fifths.
- D-10 Thumb Bass: Playing dynamics switch between thumping and popping bass.
- D-11 Sync Bass: Analog synth bass with synced oscillators. Aftertouch = vibrato.
- D-12 FullString: Large string section
- D-13 WideString: A mix of basses/cellos and violas/violins in two separate octaves. Aftertouch = vibrato
- D-14 ConvoStrgs: Sharp synth strings.
- D-15 Oh Choir: Split male and female choir "Oh". MW1 = vibrato.
- D-16 Orchestra: Full string and brass orchestra. MW1 = vibrato.

## Preset 2

- A-1 SaxSection: Sax section with tenor and alto.
- A-2 Folk 2 Gtr: Clear folk or steel guitar. MW1 = vibrato.
- A-3 Humbucker: Electric guitar with humbucking pickups, slightly chorused.
- A-4 SingleCoil: Electric guitar with single coil pickups.
- A-5 12stGuitar: Twelve string guitar, with AFM used to simulate the different tunings of the second set of strings. Aftertouch = pitch bend, MW1 = vibrato.
- A-6 Gut Guitar: Gut (nylon) string guitar. MW1 = vibrato.
- A-7 Mute E.Gtr: Muted electric guitar. Play strongly to pop the strings.
- A-8 JazzGuitar: Electric jazz guitar with harmonics in the top octave. MW1 = vibrato.
- A-9 Pick Bass: Bright picked electric bass. Velocity = dynamics over a wide range. MW1 = vibrato, MW2 = panning.
- A-10 Fretless B: Warm, fretless bass. Aftertouch = vibrato.
- A-11 FingerBass: Warm, fingered electric bass. MW1 = vibrato, MW2 control panning.
- A-12 Syn Bass: Tight, punchy synth bass. MW2 = panning.
- A-13 Plastic Bs: Synth bass in two octaves. Aftertouch = vibrato.
- A-14 Mini Bass: Synth bass, milder than A13.
- A-15 Boppa Bass: Staccato notes in the left hand give a speaking effect to this bass. Aftertouch = vibrato.

## APPENDIX

- A-16 **BreathBass**: Bass with superimposed breathy chorus, good for slow exposed bass lines. This voice will also play well in higher octaves. Aftertouch = vibrato.
- B-1 **Violin**: Solo violin. MW1 = bow “bite”, aftertouch = vibrato.
- B-2 **Pizzicato**: Pizzicato strings.
- B-3 **Contrabass**: Solo contrabass. Velocity = dynamics over a wide range. Aftertouch = vibrato.
- B-4 **Air Cello**: These cellos almost become a choir in the lower register. Aftertouch = vibrato.
- B-5 **SilkString**: Warm string ensemble swell. MW1 = vibrato, MW2 = brightness.
- B-6 **Obie Strgs**: Warm, fat analog strings. MW1 = vibrato, MW2 control brightness.
- B-7 **SizleStrgs**: Synth strings, with mixed noise. MW1 = vibrato.
- B-8 **Ah Choir**: Split male and female chorus. MW2 = filter cutoff.
- B-9 **Spirits**: Gentle female choir sound. Aftertouch = vibrato.
- B-10 **Chor Meist**: Two choirs tuned 1/5 octave apart. Aftertouch = vibrato.
- B-11 **Vibes**: Vibes played with a hard mallet. MW1 = stereo tremolo.
- B-12 **Marimba**: Normal marimba.
- B-13 **Pluck Echo**: Bright synthetic kalimba with subtle harmonic echo effect. MW1 = vibrato.
- B-14 **Bah Mallet**: Be sure to hold low notes to hear this speak. A ‘woody’ mallet percussion in the right hand. MW1 = vibrato, MW2 = pan LFO.
- B-15 **Oz Hammer**: Hold notes to hear the rhythm made with automatic EG looping. Aftertouch = vibrato.
- B-16 **Ice Chime**: Mixture of bell and wind chime, nice for glissando.
- C-1 **Shamisen**: Japanese banjo-like instrument.
- C-2 **Koto**: Japanese harp-like instrument.
- C-3 **Sitar**: Indian traditional instrument. Aftertouch = pitch bend up.
- C-4 **Steel Drum**: Steel drum. MW1 = fast tremolo, MW2 = brightness.
- C-5 **Harp**: Harp with AFM element used in the attack.
- C-6 **Accordion**: MW1 adds a slow chorus vibrato. MW2 = brightness.
- C-7 **Harmonica**: Bright harmonica. Aftertouch = pitch bend down.
- C-8 **Harpomatic**: Play sustained notes to hear the AWM harp echoed in different pitches by the AFM. MW1 = vibrato
- C-9 **Ravi Clavi**: Sitar-like clavinet. Aftertouch = pitch bend, MW1 = vibrato.
- C-10 **Forest**: Deep synth sound with distinctive lows.
- C-11 **Satin Bell**: FM piano sound accompanied by filtered strings. MW1 = vibrato.
- C-12 **Mr.Lucky**: Fat analog square lead. MW1 = vibrato, MW2 = brightness, aftertouch = dynamic left/right panning.
- C-13 **Mini Lead!**: Monophonic analog lead with fingered portamento. MW1 = vibrato.
- C-14 **Keytar**: Synth lead, with tone change for sustained notes. Aftertouch = vibrato.
- C-15 **SoloFlight**: Lead “analog” synth with filter attack. Aftertouch = vibrato.
- C-16 **Wayfarer**: Play sustained chords. MW1 = deep vibrato.
- D-1 **Brass Orch**: Full orchestra sound. Brass enters for strong notes, bell sounds for staccato. Aftertouch = vibrato.
- D-2 **Millenium!**: Synth orchestra with percussive effect and slow ambient noise crescendo. MW1 = vibrato.
- D-3 **Catharsis**: Synth pluck and choir with wind chimes and evolving crescendo effect. MW1 = vibrato.
- D-4 **MethylMist**: Atmospheric strings and effects from the moons of Jupiter. MW1 = vibrato.
- D-5 **Voyager**: Traveling outward into deep space, with slow attacking and decaying high component. MW1 = vibrato.
- D-6 **Inferno**: Percussive synth vocal, with looped noise, drum, and wind chime effect. Hold keys and wait for effect. MW1 = vibrato.
- D-7 **Valkyrie**: Synth orchestra with velocity control of synthetic cymbal burst. Hold notes in bass register for evolving harmonic effects. MW1 = vibrato.
- D-8 **Syren Song**: The lost souls and sea sounds can be found in the left with the syren’s voice in the upper octaves. Aftertouch = vibrato.
- D-9 **Anna Sweep**: Analog synth with filter sweep.
- D-10 **SyncanSyn**: Analog synth sound of the 70’s for solo or chords, with slight portamento.



- D-11 AnnaPad: Spacious, soft pad.
- D-12 Gosh!: Steamy comping sound with filter sweep. The two elements pan in opposite directions. Aftertouch = vibrato.
- D-13 Debonair: Smooth comping synth sound with filter sweep sound. Aftertouch = vibrato.
- D-14 HiddenRing: Hard staccato playing will produce the sound of the harmonics on the bass accompaniment sound.
- D-15 Drum 1: Drums assigned to the keyboard similar to the Yamaha RX series rhythm machines.
- D-16 Drum 2: Similar to Drum 1, but with different types of BD, SD, and TT.

## Using RCM hybrid synthesis

### Suggestions for using AWM × AFM (Voice modes 9 & 10)

The ability to use an AWM voice as an input to an operator is one of the radical innovations of the SY77. Since the architecture is so flexible it will be a long time before this capability can be fully explored. This section will suggest one possible starting point for experimentation.

1. Select the voice mode
  - From: Voice edit mode
  - Select: Voice mode (F1) (JUMP #200)
  - Select: Voice Mode 9 (1AFM&1AWM)
  - Press: F2 (Com)
2. Initialize the voice common data
  - From: Voice edit (JUMP #201)
  - Select: 15:Initialz (Initialize voice)
  - Press: ENTER
  - Press: YES at the "Are You sure?" prompt
  - Press: EXIT at the "Completed" prompt
3. Initialize the AFM element
  - From: Voice edit (JUMP #201)
  - Press: F3 (E1) AFM Element (JUMP #230)
  - Select: 15:Initialz (Initialize AFM element)
  - Press: ENTER
  - Press: YES at the "Are You sure?" prompt
  - Press: EXIT at the "Completed" prompt
4. Initialize the AWM element
  - From: Voice edit (JUMP #230)
  - Press: F4 (E2) AWM element (JUMP #256)
  - Select: 15:Initialz (Initialize AWM element)
  - Press: ENTER
  - Press: YES at the "Are You sure?" prompt
  - Press: EXIT at the "Completed" prompt
5. Select an AWM wave
  - Press: F4 (E2) to edit the (JUMP #256)  
AWM element
  - Select: 1:WaveSet (JUMP #257)  
(AWM waveform set)
6. To turn off the AWM:
  - From: Voice Edit (JUMP #201)
  - Select: 7:OutSel (JUMP #208)
  - Press: F2 (E2) to select element 2.
  - Press: -1 three times to turn element output off.
  - Press: EXIT to return to the voice edit job directory
7. Select Algorithm 30 (default in INIT AFM voice)
 

*Note: Any algorithm will work with hybrid voicing. However we will use the default algorithm 30 in this demonstration, so this step is not necessary.*
8. Set operators 1 and 2 to fixed frequency, zero frequency.
  - Press: F3 to select the AFM (JUMP #230)  
jobdirectory
  - Select: 2:Osclltr (JUMP #235)
  - Press: Operator Select button 1 to choose operator 1

Press: the -1 +1 buttons or use the data wheel or slider to select the wave you wish to use.

When you play the keyboard you will notice that all waves will sound with the initialized "organ type" EG, and no velocity or filtering. You will probably want to add final touches later. EG filtering and dynamic information are carried over into the FM operator. However for now we will use only a raw wave in order to explain the mechanics of RCM hybrid voicing.

Before trying to use an AWM wave in an AFM algorithm it is useful to turn off the AWM direct output. This is not necessary for final voicing since many voices use *both* the direct AWM sound and the hybrid AWM/AFM combination. However it is easier to understand the effect of the hybrid system if the direct output of the AWM element is temporarily turned off.

#### 6. To turn off the AWM:

- From: Voice Edit (JUMP #201)
- Select: 7:OutSel (JUMP #208)
- Press: F2 (E2) to select element 2.
- Press: -1 three times to turn element output off.
- Press: EXIT to return to the voice edit job directory

#### 7. Select Algorithm 30 (default in INIT AFM voice)

*Note: Any algorithm will work with hybrid voicing. However we will use the default algorithm 30 in this demonstration, so this step is not necessary.*

#### 8. Set operators 1 and 2 to fixed frequency, zero frequency.

- Press: F3 to select the AFM (JUMP #230)  
jobdirectory
- Select: 2:Osclltr (JUMP #235)
- Press: Operator Select button 1 to choose operator 1

Select: Freq Mode and use -1 +1 to change “ratio” to “fixed”  
 Select: Coarse and use -1 +1 to change 1.0 to 0.00  
 Press: Operator select button to choose OP2 and repeat the above operation.  
 Press: EXIT to return to the AFM job directory

9. Introduce the AWM wave into operator 2 of the FM algorithm

From: Voice Edit  
 Press: F3 (E1) to select the (JUMP #246)  
 AFM element for editing  
 Select: 1:Algrthm (JUMP #232)  
 (AFM algorithm)  
 Press: F2 (Extn) This page selects the external inputs to each operator.

Use the cursor keys to position the cursor over the “off” on the AWM line under OP2. Press YES to change the “off” to In1.

Press: EXIT to return to the AFM job directory

10. Raise the output level of operator 2.

From: AFM job directory  
 Select: 4:Output and press (JUMP #242)  
 F2 (All)  
 Move: the cursor to OP2 and use the data slider to gradually raise the level until you hear the AWM wave.

**Important note:** Depending on the harmonic content of the selected wave, the sound may become distorted as you increase the output level of OP2. If it does, exit to the AFM job directory, select 1:Algrthm and press F3 (Inpt) (JUMP #233). Note that under the AWM indicator beneath OP2 there is a number 7. Lower this value to 4 and then return to 4:Output (JUMP #242) and adjust the OP2 output level again. The level set for each operator in the Algorithm Input acts as a multiplier for the value specified in Output. To avoid distorting the sound appearing at Op2, you must set the correct gain values. Of course, distortion can be an interesting effect in its own right. By adjusting the operator output and operator input, a wide range of AWM input levels can be used.

The steps outlined so far may not result in a very interesting sound, but the following points will illustrate some of the possibilities of RCM hybrid synthesis.

- The AFM operator into which the AWM waveform was introduced can be modulated by other operators, or can modulate other operators.
- The same AWM waveform can be introduced into two or more AFM operators, perhaps with each operator set to a different pitch.
- Since the AWM waveform is routed through the filter of the AWM element before being introduced into the AFM operator, its filter settings can be continuously varied, resulting in a realtime filtered waveform which can be modulated by and can modulate other operators (waveforms); i.e., *Realtime Convolution and Modulation* — RCM hybrid synthesis. (“Convolution” refers to proprietary Yamaha digital filtering technology.)

It is beyond the scope of this manual to provide detailed instruction in the use of this new hybrid system although additional programming guides will be forthcoming. The only steps required for using RCM hybrid synthesis are to turn on the AWM in the Inpt page and select voice mode 9 or 10. The rest is up to you. This is simply a very basic guide which you may use as a starting point.

## Error messages

### MIDI

**MIDI buffer full !**

When the SY77 attempted to receive or transmit a large amount of MIDI data, its handling capacity was exceeded.

**MIDI data error !**

An error occurred when receiving MIDI data.

**MIDI checksum err !**

An error occurred when receiving bulk data.

**Data empty !**

Sequence data (bulk) was received, but the message contained no data.

**Bulk rejected; song exist !**

Since data for the selected song already exists in sequencer memory, the sequence data (bulk) was not received.

**Song memory full !**

When receiving sequence data (bulk), the internal memory capacity was exceeded, and not all the data was received.

**Device number is off !**

Since the device number is off, bulk data cannot be transmitted or received.

**Device number mismatch !**

Since the device numbers did not match, the bulk data was not received.

**Bulk canceled by EXIT !**

While receiving or transmitting bulk data, EXIT was pressed to abort the operation.

### Data card

**Data card not ready !**

The data card is not correctly inserted into the slot.

**Card protected !**

Since the memory protect switch of the card is on, data cannot be saved to the card.

**Illegal format !**

The card is the wrong format.

**Verify error !**

The data was not correctly saved.

### Wave card

**Wave card not ready !**

The wave card is not correctly inserted into the slot.

**Different wave card (ID= ) !**

The wave card which is inserted is not the one used by the voice or multi.

**ID Number mismatch !**

A multi includes voices which use two or more wave cards.

## Disk

**Disk not ready !**

The disk is not correctly inserted into the disk drive.

**Illegal change !**

During the backup operation, the original and back up disks were inserted in the wrong order.

**Illegal disk !**

The data in the disk is faulty.

**Bad disk !**

The disk is faulty.

**File not found !**

The file was not found.

**Write protected !**

The disk is write protected.

**Disk full !**

There is no more memory available on the disk.

**Directory full !**

The directory area on the disk is full, and new files cannot be created.

**Media type error !**

The disk is the wrong type.

**Illegal file !**

The file is not for the SY77.

**Sequencer memory full !**

The sequencer memory is full.

## Sequencer and display

**Please stop sequencer !**

The sequencer cannot play during disk or card loading or saving or during bulk data transmission.

**Illegal time !**

You attempted to execute the Get Pattern operation, but the time signature was incorrect.

**Range is exceeded !**

The parameter you specified in an edit job is beyond the valid range.

**Data not found !**

When you executed the Search Part operation in Chain Pattern, the specified data was not found.

**Illegal input !**

You attempted to enter an invalid data value in Edit Insert mode.

**Internal buffer full !**

More sequence data was played back than could be sounded.

## Battery

**Change internal battery !**

The internal backup battery needs to be replaced.

**Change card battery !**

The card backup battery needs to be replaced.

<h2>Other</h2>
----------------

**Use bank D !**

4 element voices can be stored (or copied) only to bank D.

**Please stop sequencer !**

Please stop the sequencer and try the operation once again.

**Illegal mark !**

You attempted to mark a display which does not allow marking.

**Use bank A-C !**

The voice must be stored in bank A, B, or C.

# Multi data blank chart

MULTI DATA		Multi Name										Date					
Voice Name	01				02				03				04				
	05				06				07				08				
	09				10				11				12				
	13				14				15				16				
MIDI Channel		01	02	03	04	05	06	07	08	09	10	11	12	13	14	15	16
Voice Volume																	
Voice Tuning																	
Voice Note Shift																	
Voice Static Pan																	
Voice Output Select																	
Voice Individual Output																	
Effect	Mode	Stereo Mix 1				Stereo Mix 2				Stereo Mix 2							
/		Mod. Effect 1				Mod. Effect 2				Rev. Effect 1				Rev. Effect 2			
Effect Type																	
Effect Balance																	
Output Level																	
Parameter 1																	
Parameter 2																	
Parameter 3																	
Parameter 4																	

# Specifications

## **Tone generator:** Realtime Convolution and Modulation (RCM)

AWM2: 16 bit linear waveform data, maximum 48 kHz sampling frequency

AFM: 6 operators, 45 algorithms, 3 feedback loops, 16 waveforms, modulation from AWM output

Filter: Time variant IIR (infinite impulse response) digital filters, 2 filters for each element (maximum of 8 filters per voice)

Maximum simultaneous notes: 16 notes AWM + 16 notes AFM

Maximum simultaneous timbres: 16

Note assignment: Last note priority, DVA (dynamic voice allocation)

**Keyboard:** 61 notes, key velocity sensitivity, channel aftertouch

**DSP effects:** (reverb effect + modulation effect) × 2

Reverb effects: 40 types

Modulation effects: 4 types

## **Sequencer:**

Tracks: 16 (15 tracks + 1 pattern track)

Songs: 1

Resolution: 1/96 of a quarter note (for internal clock)

Maximum simultaneous notes: 32

Capacity: approximately 16,000 notes

Patterns: 99

Recording: realtime/step/punch in

## **Memory:**

Preset memory: 128 voices, 16 multis

Internal memory: 64 voices, 16 multis

Waveform memory: 2 Mwords (4 Mbytes), 112 sounds

Card slots: synthesizer data × 1, waveform data × 1

Disk: 3.5" floppy disk drive (720 kbyte formatted)

## **Controllers:**

Wheels: PITCH, MODULATION 1, MODULATION 2

Slider: OUTPUT 1, OUTPUT 2, DATA ENTRY

Knobs: LCD contrast, click volume

Dial: data entry dial

Panel switches: MODE × 5, EDIT/COMPARE, COPY/SAVE, EF.BYPASS, SEQUENCER × 7,

SHIFT, function × 8, EXIT, PAGE <▷, JUMP/MARK, cursor Δ ▽ <▷, -1/NO, +1/YES,

numeric keypad 0-9, ENTER, , MEMORY × 4, BANK × 4, voice select × 16,

## **Display:**

LCD: 240 × 64 pixels (with backlight)

LED: red × 11, red/green × 21

## **Terminals:**

Audio output: OUTPUT 1 (L/MONO, R), OUTPUT 2 (L, R), PHONES

Controller: BREATH, FOOT VOLUME, FOOT CONTROLLER, SUSTAIN, FOOT SWITCH

MIDI: IN, OUT, THRU

## **Power requirements:**

UL, CSA: 120V

Europe, WG, Australia, BS: 220-240V

## **Power consumption:**

UL, CSA: 28W

Europe, WG, Australia, BS: 28W

## **Dimensions:**

1046(W) × 407(D) × 119(H) mm

## **Weight:** 17kg



# Index

- 1/+1 keys 21, 28
- AFM, block diagram of element 60, edit jobs 116, filter 131, in RCM hybrid synthesis 10, initialize element 135, LFO (main) 127, LFO (sub) 128, oscillator 121, pitch EG 129, sixteen types of AFM waveform 121, voices 12, used as AWM waveform 139
- AWM, block diagram of element 56, copy 138, edit jobs 138, EG 141, filter 146, LFO 144, list of waveforms 139, output 142, sensitivity 143, pitch EG 145, initialize element 147, as part of RCM hybrid synthesis 10, voices 12, input to an AFM algorithm 120
- Absolute data, how to enter 30
- Accent level, of F1–F4 in step record mode 197
- Advanced Frequency Modulation, see AFM
- Advanced Wave Memory, see AWM
- Algorithm, an arrangement of six operators 59, form 118, external input 120, input level 120, select 117
- Alternate on/off in a Drum voice 79
- Appendix 237
- Attack, adjusting the 74
- Auto-store, see Store
- Backup disk 213
- BANK keys 21
- Beat/Clock, see Clock/Beat
- BPF (Band Pass Filter) 132
- Break point, see Scaling
- BREATH jack 22
- Bulk data, receiving 222, 224, transmitting 223
- Card, format 226, load from 226, save to 225, utility jobs 225
- Chain pattern 40, 182
- Change, data in song edit mode 46, 180
- Channel, settings 221, of a multi, how to select 36
- Character data, how to enter 30
- Clear, pattern 214, song 195
- Click 204
- CLICK VOLUME knob 22
- Clock, move 191
- Clock/Beat, displayed when editing 198
- Common data, job directory 92
- Compare, voice 62, 89, multi 161
- Complex waveforms, produced by FM 58
- Confirm, edit 220
- Connections, audio 4
- CONTRAST knob 22
- Controller, how to use a 72, set (voice common data) 110–113, specify the control number transmitted by the assignable 219, view 85
- COPY key 18
- Copy, AFM element 117, AWM element 138, filter 131, measure 191, multi 158, operator 118, pattern 210, part in the pattern track 183, voice 85
- Correct the timing of recorded data, see Quantize
- Create measure 193
- Crescendo 188
- Cursor keys 21, 28
- Curve, velocity, see Velocity set
- Cutoff, EG 134, filter frequency 131, scaling 133
- Data, how to enter 28
- DATA card slot 18
- Data change and insert modes, song edit 46
- DATA ENTRY slider 21, 29
- Data entry wheel 21, 29
- Delete, file 232, measure 193, part from the pattern track 183
- Demo disk songs, how to load and play 6
- Detune, element 93
- Device number 221
- Directory, job 24, multi 157, voice 84
- Disk drive 18
- Disk, status 232, how to load and play the demo 6
- Disk utility jobs 227, save to 227, load from 229, format 230, backup 213
- Drum voice 55, controller 151, consists of 61 percussive sounds 13, edit 78, edit job directories 64, 149, effect 151, voice mode 91, voice name 152, voice volume 149, wave data set initialize 152, wave data set 150
- DSP, see Effects
- Dynamic pan, see Pan
- EDIT/COMPARE key 18

## APPENDIX

- Edit, confirm on/off 220, modes 24, pattern 209, pattern jobs 210, sequence editing jobs 17, song 46, 179, song job 48, song graph 179, song data change 180, song data insert 181, voice 53
- EFFECT BYPASS key 18
- Effect, copy from another voice 102, four DSP units 14, mode select 101, modulation 102, reverb 103, set 100, settings for a multi 37, 165
- EG, AFM operator 123, 125, AFM pitch 129, AWM 141, AWM pitch 145, filter cutoff 134
- Element, copy AFM 117, copy AWM 138, detune 93, level 92, note shift 93, pan 95, select 90, turn off unwanted 68, 90, voice consists of one two or four 12,
- Entering data 28
- Erase, event 190, measure 192, track 194
- Error messages 244
- Event, erase 190, turn reception on/off for each type of 196
- EXIT key 19
- External input, into an AFM algorithm 120
- FM, synthesis, the basics of 58,
- FOOT CONTROLLER jack 22
- FOOT SWITCH jack 23
- FOOT VOLUME jack 22
- Feedback, algorithm 118
- File (disk), delete 232, name for saving 228, rename 231, status 232
- Filter, AFM 131, AWM 146, copy 131, cutoff scaling 133, two provided for each element 14, ways to control 69, 133, what is a 68
- Fixed velocity transmitted by keyboard 217
- Form, algorithm 118
- Format, card 226, disk 50, 230
- Frequency, filter cutoff 131, mode of AFM oscillator 121
- Front panel 18–21
- Function keys 19, to select jobs 25
- Gate time, modify 186
- Get pattern from a track 211
- Graph song editing mode 46, 179
- Greeting message 220
- Group, output of each element 99
- HPF (High Pass Filter) 132
- Hybrid synthesis, about RCM 10, tutorial in using RCM 242
- Initialize, AFM element 135, AWM element 147, drum set 152, multi 166, voice 113
- Input level, algorithm 120
- Insert, data in song edit mode 46, 181, a part in the pattern track 183
- Introducing the SY77 3
- Job directories 24, AFM element edit 116, AWM element edit 138, common data edit 92, drum set edit 149, multi edit 161, pattern edit 210, pattern setup 213, song edit 185, song setup 196
- JUMP/MARK key 21
- Jump function 26
- Keyboard 18, transmit channel of 221, velocity transmitted by 217
- LCD (Liquid Crystal Display) 18
- Level, element 92
- LFO (Low Frequency Oscillator), AFM main 127, AFM sub 128, AWM 144, used to create vibrato 70
- Limit, note 94, velocity 94
- Load, demo disk songs 6, from card 226, from disk 229
- Local on/off 221
- LOCATE key 19
- Locate, marked position in song 172
- Loop, AFM EG 124, 125
- LPF (Low Pass Filter) 132
- MEMORY keys 21
- MIDI IN, OUT, THRU terminals 22
- MIDI control, of sequencer timing 197
- MIDI utility jobs 221
- Main modes, five 24
- Marked pages, jumping between two 26
- Master tuning 217
- Measure, copy 191, create 193, delete 193, erase 192
- Message, greeting 220
- Metronome, see Click
- Micro tuning 106, copy 108, edit 108, name 109
- Mix track 194
- Mode select keys 18
- Mode, effect 66, five main 24, voice 54
- Modify, gate time 186, velocity 187
- Modulation, effect 102, controller set 110, wheels 18
- Mono voice modes 91

- Move around the SY77, how to 24
- Move clock 191
- Multi, compare 161, copy 158, directory 157, edit job directory 161, effect 37, 165, explanation of 16, how to set up 36, initialize 166, list of preset 8, mode 159, name 166, note shift 164, pan 164, play mode 155, recall 167, select 157, store 161, voice select 162, voice volume 163, voice tuning 163, voice output group 165,
- Mute, playback tracks 172
  
- Name, drum set 152, multi 166, song 199, voice 113
- Noise, input to an algorithm 120
- Normal voice, see Voice
- Note capacity of sequencer 173
- Note on/off (all, odd, or even) 221
- Note shift, song edit job 190, voice common data 93, voice in multi 164
- Note limit 94
- Numeric key pad 21, 30
  
- Operator, EG 123, on/off 117, waveform and frequency 121–123
- Oscillator, AFM 121
- Other, controller set 112
- OUTPUT jacks 23
- Output channel of sequencer 197
- Output group select, voice common data 99, voice in multi 165
- Output, AWM 142, level of AFM operator 125, 126
  
- PAGE keys 21, to move between jobs 25
- PHONES jack 23
- POWER switch 23
- Pan, controller set 111, copy 97, edit 96, EG 98, independent for each element 14, name 99, select for each element 95, source 97, static pan of voice in multi 164
- Pattern recording, two methods of 17
- Pattern, chain 182, clear 214, copy 210, edit 209, edit jobs 210, get 211, mode 201, how play and edit modes are organized 203, placed in the pattern track 40, play 204, put 211, put chain 212, record 205, setup jobs 213, used in a song 17, used to record rhythm sounds 38
- Pitch EG, AFM 129, 130, AWM 145
- Pitch bend, controller set 110
- Pitch wheel 18
- Pitch, random 99
- Play modes and edit modes 24
- Play pattern 204
- Playback, select and mute tracks for 172
- Polyphonic voice modes 91
- Polyphony, of AFM and AWM tone generators 13
- Portamento 100
- Power cable 23
- Preset, list of multis 8, list of voices 5, explanation of voices 238
- Program change, reception and transmission 222, send while in voice play or multi play modes 86, 158
- Program select keys 21
- Punch-in recording 16, 44, song 176
- Put, chain pattern 212, pattern 211
  
- Quantize 186
  
- Random pitch 99
- Rate scaling, AFM EG 124, AWM EG 141
- RCM hybrid synthesis 10, a tutorial in using 242
- Realtime digital filter, see Filter
- Realtime recording 16, 42, pattern 17, song 175, pattern 206
- Rear panel 22
- Recall, multi 167, voice 115, 137
- Receive, channel for voice mode 221, event 196
- RECORD key 19
- Record, pattern 205, pattern realtime 206, pattern step 207, song 8, 174, song realtime 175, song punch-in 176, song step 177, three ways to 16
- Relative tempo data 182
- Rename disk file 231
- Repeat marks, in a pattern 40
- Reverb, effect 103, simple editing of 66
- Rhythm pattern, see Pattern
- RUN key 19
  
- Save, to card 225, to disk 227
- Scaling, AFM rate 124, 125, AFM output 125, filter cutoff 133, AWM rate 142, AWM output 142
- Select and play voices, how to 4
- Send program change 86, 158
- Sensitivity, AFM 127, AWM 143
- Sequence, editing jobs 17, loading other types of data 229, saving other types of data 227,
- Sequencer, control keys 18, controls the tone generator 34, how to use the 33, multi-timbral 16, output channel 197, simultaneous note capacity of 173, timing control 197
- Setup and play, how to 4
- Setup jobs, pattern 213, song 196
- SHIFT key 19

## APPENDIX

- Simultaneous note capacity of sequencer 173
- Slider, data entry, see Data entry slider
- Song edit job, directory 185, using a 48
- Song, clear 195, edit 46, 179, how to record 8, mode 169, name 199, play 172, record 174, setup jobs 196, song play and song edit modes 171
- Status, of disk 232
- Step record 16, pattern 17, song 177, specify F1–F4 accent levels for 197
- STOP key 19
- Store, multi 161, voice 63, 76, 89
- SUSTAIN jack 23
- Synthesis methods using RCM 10
- System utility jobs 217
  
- Temperament, see Micro tuning
- Tempo, relative (sequence data) 182
- Thin out 189
- Timing, correct for recorded data, see Quantize
- Tone, simple ways to modify the 68
- Tone generator and sequencer 34
- Track, erase 194, mix 194, sequencer 16, 35, select for playback 172
- Transmit channel for keyboard 221
- Transpose 189
- Tuning, master 217, micro 106, of voice in multi 163
  
- Tutorial, how to use the sequencer 35, how to edit a voice 53, using RCM hybrid synthesis 242
  
- Utility, card 225, disk 227, MIDI 221, mode 215, system 217
  
- Velocity, limit 94, modify (of recorded song data) 187, set (curve) 217
- Velocity sensitivity, see Sensitivity
- Vibrato, how to add 70
- Voice, copy 85, directory 84, drum 13, explanation of presets 238, initialize 113, list of presets 5, mode select 91, name 113, play mode 83, recall 115, 137, select 84, what is a 54
- Voice (in a multi), select 162, volume 163, tuning 163, Voice common data, see Common data
- Voice edit, jobs 64, mode 87, process of 62
- VOLUME sliders 18
- Volume, overall voice 92, drum set voice 151, voice in multi 163
  
- WAVEFORM card slot 18
- Waveform, list of AWM 139–140, sixteen types usable in an AFM algorithm 121–123
- Wheel, data entry, see Data entry wheel

# IMPORTANT SAFETY AND INSTALLATION INSTRUCTIONS

---

INFORMATION RELATING TO POSSIBLE PERSONAL INJURY, ELECTRIC SHOCK, AND FIRE HAZARD POSSIBILITIES HAS BEEN INCLUDED IN THIS LIST.

**WARNING** — When using electronic products, basic precautions should always be followed, including the following:

1. Read all Safety and Installation Instructions, Supplemental Marking and Special Message Section data, and any applicable assembly instructions **BEFORE** using this product.
2. Check unit weight specifications **BEFORE** you attempt to move this product.
3. Main power supply verification. Yamaha Digital Musical Instrument products are manufactured specifically for use with the main supply voltage used in the area where they are to be sold. The main supply voltage required by these products is printed on the name plate. For name plate location please refer to the graphic in the Special Message section. If any doubt exists please contact the nearest Yamaha Digital Musical Instrument retailer.
4. Some Yamaha Digital Musical Instrument products utilize external power supplies or adapters. Do **NOT** connect products of this type to any power supply or adapter other than the type described in the owners manual or as marked on the unit.
5. This product may be equipped with a plug having three prongs or a polarized line plug (one blade wider than the other). If you are unable to insert the plug into the outlet, contact an electrician to have the obsolete outlet replaced. Do **NOT** defeat the safety purpose of the plug. Yamaha products not having three prong or polarized line plugs incorporate construction methods and designs that do not require line plug polarization.
6. **WARNING** — Do **NOT** place objects on the power cord or place the unit in a position where any one could walk on, trip over, or roll anything over cords of any kind. An improper installation of this type can create the possibility of a fire hazard and/or personal injury.
7. Environment: Your Yamaha Digital Musical Instrument should be installed away from heat sources such as heat registers and/or other products that produce heat.
8. Ventilation: This product should be installed or positioned in a way that its placement or location does not interfere with proper ventilation.
9. Yamaha Digital Musical Instrument products are frequently incorporated into “Systems” which are assembled on carts, stands, or in racks. Utilize only those carts, stands, or racks that have been designed for this purpose and observe all safety precautions supplied with the products. Pay special attention to cautions that relate to proper assembly, heavier units being mounted at the lower levels, load limits, moving instructions, maximum usable height and ventilation.
10. Yamaha Digital Musical Instrument products, either alone or in combination with amplification, headphones, or speakers, may be capable of producing sound levels that could cause permanent hearing loss. Do **NOT** operate at high volume levels or at a level that is uncomfortable. If you experience any discomfort, ringing in the ears, or suspect any hearing loss, you should consult an audiologist.
11. Do **NOT** use this product near water or in wet environments. For example, near a swimming pool, spa, in the rain, or in a wet basement.
12. Care should be taken so that objects do not fall, and liquids are not spilled into the enclosure.
13. Yamaha Digital Musical Instrument products should be serviced by a qualified service person when:
  - a. The power supply/power adapter cord or plug has been damaged; or
  - b. Objects have fallen, or liquid has been spilled into the product; or
  - c. The unit has been exposed to rain; or
  - d. The product does not operate, exhibits a marked change in performance; or
  - e. The product has been dropped, or the enclosure of the product has been damaged.
14. When not in use, always turn your Yamaha Digital Musical Instrument equipment “OFF”. The power supply cord should be unplugged from the outlet when the equipment is to be left unused for a long period of time. **NOTE:** In this case, some units may lose some user programmed data. Factory programmed memories will not be affected.
15. Electromagnetic Interference (RFI). Yamaha Digital Musical Instruments utilize digital (high frequency pulse) technology that may adversely affect Radio/TV reception. Please read FCC Information (next page) for additional information.
16. Do **NOT** attempt to service this product beyond that described in the user maintenance section of the owners manual. All other servicing should be referred to qualified service personnel.

---

**PLEASE KEEP THIS MANUAL  
FOR FUTURE REFERENCE!**

---

\* This applies only to products distributed by YAMAHA CORPORATION OF AMERICA.

# SPECIAL MESSAGE SECTION

**ELECTROMAGNETIC INTERFERENCE (RFI):** Your Yamaha Digital Musical Instrument Product has been type tested and found to comply with all applicable regulations. However, if it is installed in the immediate proximity of other electronic devices, some form of interference may occur. For additional RFI information see FCC Information section located in this manual.

**IMPORTANT NOTICE:** This product has been tested and approved by independent safety testing laboratories in order that you may be sure that when it is properly installed and used in its normal and customary manner, all foreseeable risks have been eliminated. **DO NOT** modify this unit or commission others to do so unless specifically authorized by Yamaha. Product performance and/or safety standards may be diminished. Claims filed under the expressed warranty may be denied if the unit is/has been modified. Implied warranties may also be affected.

**SPECIFICATIONS SUBJECT TO CHANGE:** The information contained in this manual is believed to be correct at the time of printing. Yamaha reserves the right to change or modify specifications at any time without notice or obligation to update existing units.

**NOTICE:** Service charges incurred due to a lack of knowledge relating to how a function or effect works (when the unit is operating as designed), are not covered by the manufacturer's warranty. Please study this manual carefully before requesting service.

**NAMEPLATE LOCATION:** The following graphic indicates the location of the Name Plate on your Yamaha Digital Musical Instrument. The Model, Serial Number, Power requirements, etc., are indicated on this plate.

You should note the model, serial number and the date of purchase in the spaces provided below and retain this manual as a permanent record of your purchase.

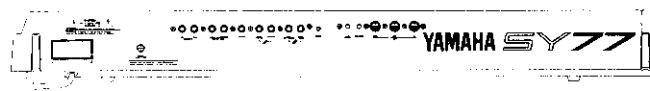

**STATIC ELECTRICITY CAUTION:** Some Yamaha Digital Musical Instrument products have modules that plug into the unit to perform various functions. The contents of a plug-in module can be altered/damaged by static electricity discharges. Static electricity build-ups are more likely to occur during cold winter months (or in areas with very dry climates) when the natural humidity is low. To avoid possible damage to the plug-in module, touch any metal object (a metal desk lamp, a door knob, etc.) before handling the module. If static electricity is a problem in your area, you may want to have your carpet treated with a substance that reduces static electricity build-up. See your local carpet retailer for professional advice that relates to your specific situation.

Model \_\_\_\_\_

Serial No. \_\_\_\_\_

Purchase Date \_\_\_\_\_

\* This applies only to products distributed by YAMAHA CORPORATION OF AMERICA.

## FCC INFORMATION (U.S.A.)

- IMPORTANT NOTICE: DO NOT MODIFY THIS UNIT!**  
This product, when installed as indicated in the instructions contained in this manual, meets FCC requirements. Modifications not expressly approved by Yamaha may void your authority, granted by the FCC, to use the product.
- IMPORTANT:** When connecting this product to accessories and/or another product use only high quality shielded cables. Cable/s supplied with this product **MUST** be used. Follow all installation instructions. Failure to follow instructions could void your FCC authorization to use this product in the USA.
- NOTE:** This product has been tested and found to comply with the requirements listed in FCC Regulations, Part 15 for Class "B" digital devices. Compliance with these requirements provides a reasonable level of assurance that your use of this product in a residential environment will not result in harmful interference with other electronic devices. This equipment generates/uses radio frequencies and, if not installed and used according to the instructions found in the users manual, may cause interference harmful to the operation of other electronic devices. Compliance with FCC regulations does not guarantee that interference will not occur in all installations. If this product is found to be the source of interference, which can be determined by turning the unit "OFF" and "ON", please try to eliminate the problem by using one of the following measures:

Relocate either this product or the device that is being affected by the interference.

Utilize power outlets that are on different branch (circuit breaker or fuse) circuits or install AC line filter/s.

In the case of radio or TV interference, relocate/reorient the antenna. If the antenna lead-in is 300 ohm ribbon lead, change the lead-in to co-axial type cable.

If these corrective measures do not produce satisfactory results, please contact the local retailer authorized to distribute this type of product. If you can not locate the appropriate retailer, please contact Yamaha Corporation of America, Electronic Service Division, 6600 Orangethorpe Ave, Buena Park, CA 90620

\* This applies only to products distributed by YAMAHA CORPORATION OF AMERICA.

For details of software, please contact our nearest subsidiary/ or the authorized distributor listed below.

Die Einzelheiten zu Software sind bei unseren unten aufgeführten Niederlassungen und Vertragshändlern in den jeweiligen Bestimmungsländern erhältlich.

Pour plus de détails sur les logiciels, veuillez-vous adresser au concessionnaire/distributeur pris dans la liste suivante le plus proche de chez vous.

Para detalles sobre el software, póngase en contacto con nuestra subsidiaria o distribuidor autorizado enumerados a continuación.

## NORTH AMERICA

### CANADA

**Yamaha Canada Music Ltd.**  
135 Milner Avenue, Scarborough, Ontario,  
M1S 3R1, Canada  
Tel: 416-298-1311

### U.S.A.

**Yamaha Corporation of America,  
Synthesizer, Guitar, and Drum Division**  
6600 Orangehorpe Ave., Buena Park, Calif. 90620,  
U.S.A.  
Tel: 1-800-443-2232

## MIDDLE & SOUTH AMERICA

### MEXICO

**Yamaha De Mexico S.A. De C.V.,  
Departamento de ventas**  
Javier Rojo Gomez No.1149, Col. Gpe Del  
Moral, Deleg. Iztapalapa, 09300 Mexico, D.F.  
Tel: 686-00-33

### BRASIL

**Yamaha Musical Do Brasil LTDA.**  
Ave. Rebouças 2636, São Paulo, Brasil  
Tel: 55-11 853-1377

### PANAMA

**Yamaha De Panama S.A.**  
Edificio Interseco, Calle Elvira Mendez no.10, Piso  
3, Oficina #105, Ciudad de Panama, Panama  
Tel: 507-69-5311

### OTHER LATIN AMERICAN COUNTRIES AND CARIBBEAN COUNTRIES

**Yamaha Music Latin America Corp.**  
6101 Blue Lagoon Drive, Miami, Florida 33126,  
U.S.A.  
Tel: 305-261-4111

## EUROPE

### THE UNITED KINGDOM/IRELAND

**Yamaha-Kemble Music(U.K.) Ltd.**  
Sherbourne Drive, Tilbrook, Milton Keynes, MK7  
8BL, England  
Tel: 0908-366700

### GERMANY/SWITZERLAND

**Yamaha Europa GmbH.**  
Siemensstraße 22-34, D-2084 Rellingen, F.R. of  
Germany  
Tel: 04101-3030

### AUSTRIA/HUNGARY

**Yamaha Music Austria GmbH.**  
Schletergasse 20, A-1100 Wien Austria  
Tel: 0222-60203900

### THE NETHERLAND

**Yamaha Music Benelux B.V.,  
Verkoop Administratie**  
Postbus 1441, 3500 BK, Utrecht, The Netherland  
Tel: 030-308711

### BELGIUM/LUXEMBOURG

**Yamaha Music Benelux B.V.,  
Administration des Ventes**  
Rue de Bosnie 22, 1060 Bruxelles, Belgium  
Tel: 02-5374480

### FRANCE

**Yamaha Musique France, Division Produits  
Professionnels**  
BP 70-77312 Marne-la-Vallée Cedex 2, France  
Tel: 01-64-61-4000

### ITALY

**Yamaha Musica Italia S.P.A.,  
Combo Division**  
Viale Italia 88, 20020 Lainate(Milano), Italy  
Tel: 02-937-4081

### SPAIN

**Yamaha-Hazen Electronica Musical, S.A.**  
Jorge Juan 30, 28001, Madrid, Spain  
Tel: 91-577-7270

### PORTUGAL

**Valentim de Carvalho CI SA**  
Estrada de Porto Salvo, Paço de Arcos 2780 Oeiras,  
Portugal  
Tel: 01-443-3398/4030/1823

### GREECE

**Philippe Nakas S.A.**  
Navarinou Street 13, P.Code 10680, Athens, Greece  
Tel: 01-364-7111

### SWEDEN

**Yamaha Scandinavia AB**  
J. A. Wettergrens gata 1, Box 30053, 400 43  
Göteborg, Sweden  
Tel: 031-496090

### DENMARK

**Yamaha Scandinavia Filial Danmark**  
Finsensvej 86, DK-2000 Fredenksberg, Denmark  
Tel: 31-87 30 88

### FINLAND

**Fazer Music Inc.**  
Länsituulentie 1A, SF-02100 Espoo, Finland  
Tel: 90-435 011

### NORWAY

**Narud Yamaha AS**  
Østerdalen 29, 1345 Østerås  
Tel: 02-24 47 90

### ICELAND

**Páll H. Pálsson**  
P.O. Box 85, Reykjavik, Iceland  
Tel: 01-19440

### EAST EUROPEAN COUNTRIES (Except HUNGARY)

**Yamaha Europa GmbH.**  
Siemensstraße 22-34, D-2084 Rellingen, F.R. of  
Germany  
Tel: 04101-3030

### UNION OF SOVIET SOCIALIST REPUBLICS

**Yamaha Corporation, Asia Oceania Group**  
Nakazawa-cho 10-1, Hamamatsu, Japan 430  
Tel: 81(Country Code)534-60-2311

## AFRICA

### MOROCCO

**Yamaha-Hazen Electronica Musical, S.A.**  
Jorge Juan 30, 28001, Madrid, Spain  
Tel: 91-577-7270

### OTHER COUNTRIES

**Yamaha Musique France, Division Export**  
BP 70-77312 Marne-la-Vallée Cedex 2, France  
Tel: 01-64-61-4000

## MIDDLE EAST ASIA

### ISRAEL

**R.B.X. International Co., Ltd.**  
P.O. Box 11136, Tel-Aviv 61111, Israel  
Tel: 3-298-251

## OTHER COUNTRIES

**Yamaha Musique France, Division Export**  
BP 70-77312 Marne-la-Vallée Cedex 2, France  
Tel: 01-64-61-4000

## ASIA

### HONG KONG

**Tom Lee Music Co., Ltd.**  
15/F., World Shipping Centre, Harbour City,  
7 Canton Road, Kowloon, Hong Kong  
Tel: 3-722-1098

### INDONESIA

**PT. Nusantik**  
Gedung Yamaha Music Center, Jalan Jend. Gatot  
Subroto Kav. 4, Jakarta 12930, Indonesia  
Tel: 21-520-2577

### KOREA

**Cosmos Corporation**  
131-31 Neung-dong, Sungdong-ku, Seoul, Korea  
Tel: 2-466-0021-5

### MALAYSIA

**Yamaha Music Malaysia Sdn., Bhd.**  
16-28, Jalan SS 2/72, Petaling Jaya, Selangor,  
Malaysia  
Tel: 3-717-8977

### PHILIPPINES

**Yupangco Music Corporation**  
339 Gil J. Puyat Avenue, Makati, Metro Manila  
1200, Philippines  
Tel: 2-85-7070

### SINGAPORE

**Yamaha Music Asia Pte., Ltd.**  
80 Tannery Lane, Singapore 1334, Singapore  
Tel: 747-4374

### TAIWAN

**Kung Hsue She Trading Co., Ltd.**  
KHS Fu Hsing Building, 322, Section 1, Fu-Hsing  
S. Road, Taipei 10640, Taiwan. R.O.C.  
Tel: 2-709-1266

### THAILAND

**Siam Music Yamaha Co., Ltd.**  
933/1-7 Rama I Road, Patumwan, Bangkok,  
Thailand  
Tel: 2-215-0030

### THE PEOPLE'S REPUBLIC OF CHINA AND OTHER ASIAN COUNTRIES

**Yamaha Corporation, Asia Oceania Group**  
Nakazawa-cho 10-1, Hamamatsu, Japan 430  
Tel: 81(Country Code)534-60-2311

## OCEANIA

### AUSTRALIA

**Yamaha Music Australia Pty. Ltd.**  
17-33 Market Street, South Melbourne, Vic. 3205,  
Australia  
Tel: 3-699-2388

### NEW ZEALAND

**Music Houses of N.Z. Ltd.**  
146/148 Captain Springs Road, Te Papapa,  
Auckland New Zealand  
Tel: 9-640-099

### COUNTRIES AND TRUST TERRITORIES IN PACIFIC OCEAN

**Yamaha Corporation, Asia Oceania Group**  
Nakazawa-cho 10-1, Hamamatsu, Japan 430  
Tel: 81(Country Code)534-60-2311

**HEAD OFFICE** Yamaha Corporation, Electronic Musical Instrument Division  
Nakazawa-cho 10-1, Hamamatsu, Japan 430  
Tel: 81(Country Code)-53-460-2445

(SY)

## SERVICE

This product is supported by YAMAHA's worldwide network of factory trained and qualified dealer service personnel. In the event of a problem, contact your nearest YAMAHA dealer.

# YAMAHA

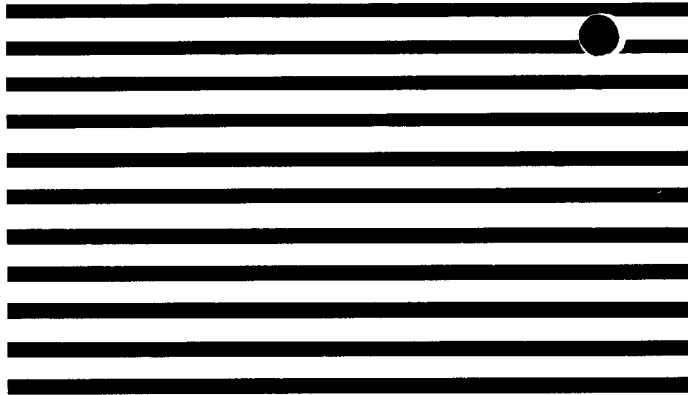

YAMAHA CORPORATION  
P.O.Box 1, Hamamatsu, Japan

VJ58400 91041.1 R11 ITP Printed in Japan