

# YAMAHA AX-1050 *RS*

*Natural Sound Stereo Integrated Amplifier*

*Préampli/ampli de puissance stéréo de la série "Natural Sound"*

*Natural Sound Vollverstärker*

*Natural Sound Integrerad Stereo Förstärkare*

*Amplificatore integrato stereo a suono naturale*

CENTER

OWNER'S MANUAL  
MODE D'EMPLOI  
BEDIENUNGSANLEITUNG  
BRUKSANVISNING  
MANUALE DELL'UTENTE

## SUPPLIED ACCESSORIES

## ACCESSOIRES FOURNIS

## MITGELIEFERTE ZUBEHÖRTEILE

## MEDFÖLJANDE TILLBEHÖR

## ACCESSORI IN DOTAZIONE

- After unpacking, check that the following parts are contained.
- Après le déballage, vérifier que les pièces suivantes sont incluses.
- Nach dem Auspacken überprüfen, ob die folgenden Teile vorhanden sind.
- Kontrollera efter det apparaten packats upp att följande delar finns med.
- Disimballato l'apparecchio, controllate di possedere tutte le parti menzionate.

- Remote-Control Transmitter
- Emetteur de télécommande
- Fernbedienungsgeber
- Fjärrkontrollsändare
- Trasmittente del telecomando

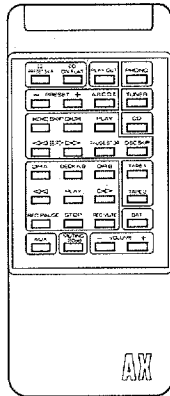

- Batteries (size "AA", R6)
- Piles (taille "AA", R6)
- Batterien (gröÖ "AA", R6)
- Batterier (storlek "AA", R6)
- Batterie (taglia "AA", R6)

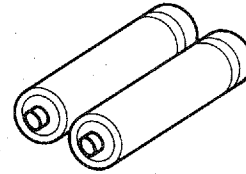

## OPEN/CLOSE THE CONTROL DOOR

When it is not necessary to operate controls inside the control door, close the control door.

## OUVERTURE/FERMETURE DU PORTILLON DES COMMANDES

Lorsque l'on n'utilise pas les commandes situées derrière le portillon, le garder fermé.

## REGLERFACHABDECKUNG

Schließen Sie die Reglerfachabdeckung, wenn Sie die dahinter befindlichen Bedienelemente nicht benutzen.

## ÖPPNING OCH STÄNGNING AV LUCKAN TILL KONTROLLERNA

När det inte är nödvändigt att ändra inställningen på kontrollerna innanför luckan, tillse att den är stängd.

## APERTURA E CHIUSURA DEL PORTELLO DEI COMANDI

Quando i comandi contenuti all'interno del portello non vengono utilizzati, chiudere il portello stesso.

To close the door  
Ouverture  
Schließen  
Öppning  
Per richiudere il portello

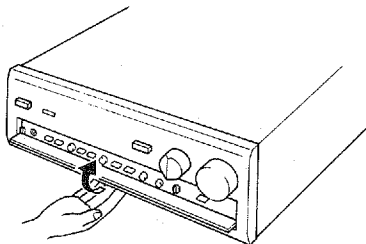

To open the door  
Fermeture  
Öffnen  
Stängning  
Per aprire il portello

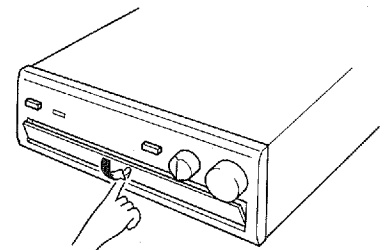

This product complies with the radio frequency interference requirements of the Council Directive 82/499/EEC and/or 87/308/EEC.

Cet appareil est conforme aux prescriptions de la directive communautaire 87/308/CEE.

Diese Geräte entsprechen der EG-Richtlinie 82/499/EWG und/oder 87/308/EWG.

Dette apparat overholder det gældende EF-direktiv vedrørende radiostøj.

Questo apparecchio è conforme al D.M.13 aprile 1989 (Direttiva CEE/87/308) sulla soppressione dei radiodisturbi.

Thank you for selecting this YAMAHA stereo amplifier.

## FEATURES

- 145W+145W (8Ω) RMS Output Power, 0.01% THD, 20-20,000 Hz
- PURE DIRECT switch to Reproduce the Purest Source Sound
- Turnover frequency switch for tone controls
- Increased Low Impedance Drive Ability
- High Quality Component Parts
- Remote Control Capability

## CONTENTS

Supplied Accessories .....	2
Caution .....	3
Connections .....	4
Operations .....	6
Remote-Control Transmitter .....	9
Notes about the Remote-Control Transmitter .....	10
Troubleshooting .....	10
Specifications .....	11

## CAUTION: READ THIS BEFORE OPERATING YOUR UNIT.

1. To assure the finest performance, please read this manual carefully. Keep it in a safe place for future reference.
2. Install this unit in a cool, dry, clean place – away from windows, heat sources, sources of excessive vibration, dust, moisture and cold. Avoid sources of humming (transformers, motors). To prevent fire or electrical shock, do not expose the unit to rain or water.
3. Never open the cabinet. If something drops into the set, contact your dealer.
4. Do not use force on switches, controls or connection wires. When moving the unit, first disconnect the power plug and the wires connected to other equipment. Never pull the wire itself.
5. The openings on the cabinet assure proper ventilation of the amplifier. If these openings are obstructed, the temperature inside the cabinet will rise rapidly and eventually damage the circuits. Therefore, avoid placing objects against these openings and do not install the amplifier where the flow of air through the ventilation openings could be impeded.
6. Always set the VOLUME control to “ – ∞ ” before starting the audio source play: increase the volume gradually to an appropriate level after the play has been started.
7. Do not attempt to clean the unit with chemical solvents; this might damage the finish. Use a clean, dry cloth.
8. Be sure to read the “TROUBLESHOOTING” section regarding common operating errors before concluding that the unit is faulty.
9. When not planning to use this unit for long periods of time (ie., vacation, etc.), disconnect the AC power plug from the wall outlet.
10. To prevent lightning damage, disconnect the AC power plug and disconnect the antenna cable when there is an electrical storm.
11. Grounding or polarization – Precautions should be taken so that the grounding or polarization of an appliance is not defeated.
12. AC outlet (General Model Only)  
Do not connect audio equipment to the AC outlet on the rear panel if that equipment requires more power than the outlet is rated to provide.
13. Voltage Selector (General Model Only)  
**The voltage selector on the rear panel of this unit must be set for your local main voltage BEFORE plugging into the AC main supply.**  
Voltages are 110/120/220/240 V AC, 50/60 Hz.

### IMPORTANT

Please record the serial number of this unit in the space below.

Serial No.:

The serial number is located on the rear of the unit.  
Retain this Owner's Manual in a safe place for future reference.

### WARNING

TO REDUCE THE RISK OF FIRE OR ELECTRIC SHOCK, DO NOT EXPOSE THIS UNIT TO RAIN OR MOISTURE.

### CAUTION (FOR CANADA MODEL)

TO PREVENT ELECTRIC SHOCK, DO NOT USE THIS (POLARIZED) PLUG WITH AN EXTENSION CORD RECEPTACLE OR OTHER OUTLET UNLESS THE BLADES CAN BE FULLY INSERTED TO PREVENT BLADE EXPOSURE.

### FOR CANADIAN CUSTOMER

THIS DIGITAL APPARATUS DOES NOT EXCEED THE “CLASS B” LIMITS FOR RADIO NOISE EMISSIONS FROM DIGITAL APPARATUS SET OUT IN THE RADIO INTERFERENCE REGULATION OF THE CANADIAN DEPARTMENT OF COMMUNICATIONS.

### CAUTION

The power switch does not disconnect the complete apparatus from the mains line.

## Special Instructions for U.K. Model

### IMPORTANT

THE WIRES IN THE MAINS LEAD ARE COLOURED IN ACCORDANCE WITH THE FOLLOWING CODE:

Blue: NEUTRAL  
Brown: LIVE

As the colours of the wires in the mains lead of this apparatus may not correspond with the coloured markings identifying the terminals in your plug, proceed as follows:  
The wire which is coloured BLUE must be connected to the terminal which is marked with the letter N or coloured BLACK.  
The wire which is coloured BROWN must be connected to the terminal which is marked with the letter L or coloured RED.  
Making sure that neither core is connected to the earth terminal of the three pin plug.

# CONNECTIONS

Before attempting to make any connections to or from this unit, be sure to first switch OFF the power to this unit and to any other components to which connections are being made.

## AUDIO CONNECTIONS

When making connections between this unit and other components, be sure all connections are made correctly, that is to say **L** (left) to **L**, **R** (right) to **R**; "+" to "+" and "-" to "-". Also, refer to the owner's manual for each component to be connected to this unit.

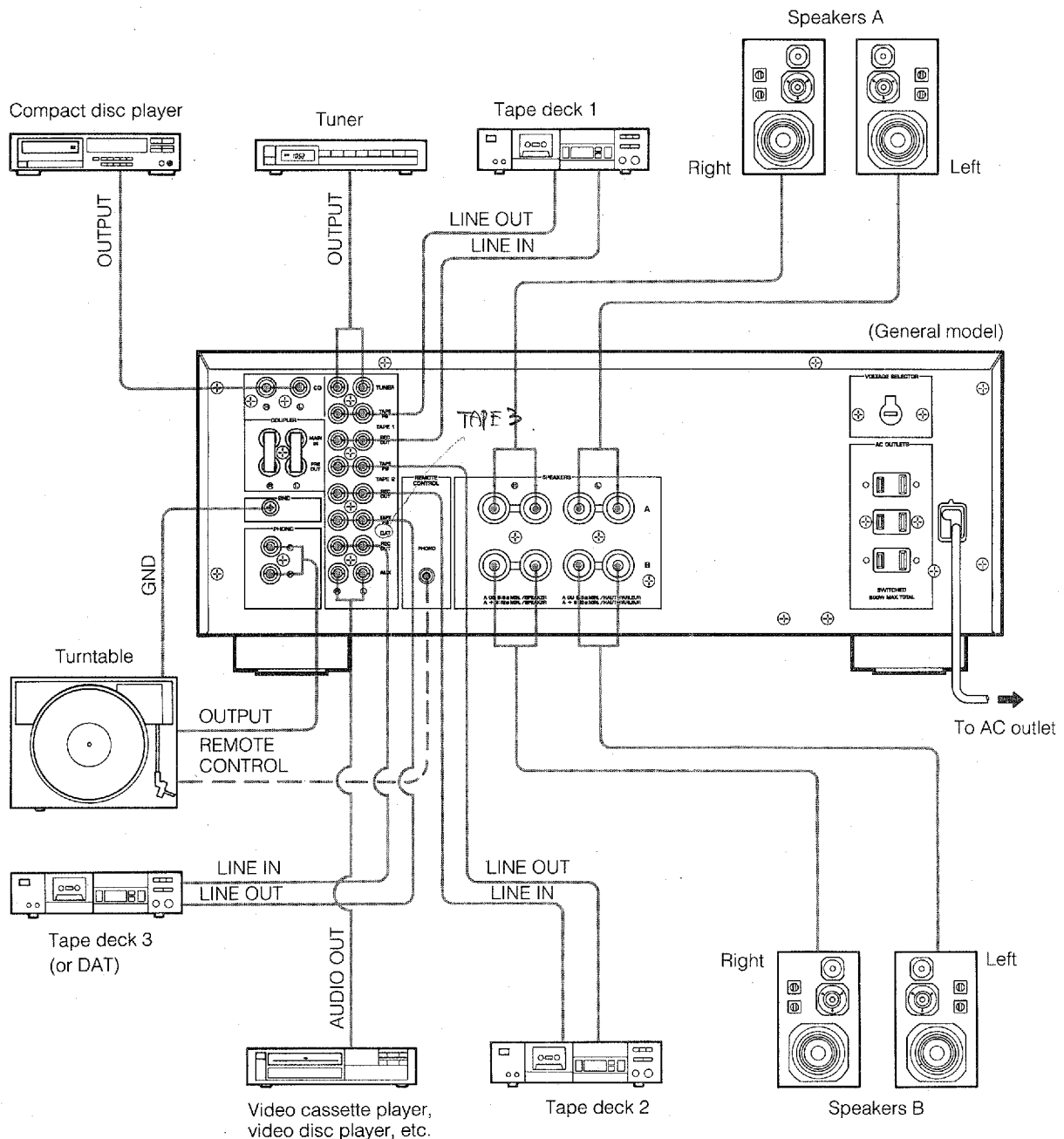

## CONNECTING SPEAKER SYSTEMS

Connect the **SPEAKERS** terminals to your speakers with wire of the proper gauge, cut to be as short as possible. If the connection are faulty, no sound will be heard from the speakers. Make sure that the polarity of the speaker wires is correct, that is, + and - markings are observed. If these wires are reversed, the sound will be unnatural and will lack bass.

**Do not let the bare speaker wires touch each other and do not let them touch the metal parts of this unit as this could damage this unit and/or speakers.**

- One or two speaker systems can be connected to this unit. If you connect only one speaker system, connect it to either **SPEAKERS A** or **B** terminals.
- Use speakers with the specified impedance shown on the rear of this unit.

### HOW TO CONNECT

The following way is recommended to connect speaker systems.

**Red: positive (+)**  
**Black: negative (-)**

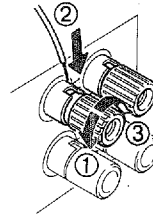

- ① Unscrew the knob.
- ② Insert the bare wire.
- ③ Tighten the knob and secure the wire.

This way is also available to connect speaker systems. (Except Scandinavian model)

**Red: positive (+)**  
**Black: negative (-)**

\* Insert the banana plug connectors into their corresponding terminals.

## ABOUT THE ACCESSORY TERMINALS

### • PRE OUT/MAIN IN terminals

Removing the jumper pins enables this unit to independently perform the functions of a control amplifier and a power amplifier. These terminals are for connection of a signal-processing system such as a graphic equalizer or sound processor.

If a sound processor or other component is connected, the **VOLUME** control of this unit can be used for overall adjustment of the level of sound. To connect such a unit, remove the jumper pins from the **PRE OUT/MAIN IN** terminals, connect the inputs of that unit to the **PRE OUT** terminals and its outputs to the **MAIN IN** terminals. For details, refer to the owner's manual included with the unit to be connected.

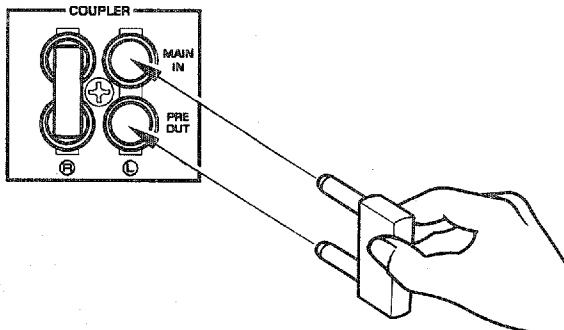

### • REMOTE CONTROL (PHONO) connector

If you have a YAMAHA turntable with the mark, connect it to this connector by using the cable provided with the turntable. This connection allows you to control the turntable from the provided remote-control transmitter.

### • GND terminal (For turntable use)

Connecting the ground wire of the turntable to this terminal will minimize hum, but in some cases better results may be obtained with the ground wire disconnected.

### • AC OUTLETS (General model only)

Use these to connect the power cords from your components to this unit.

The power to the **SWITCHED** outlets is controlled by this unit's **POWER** switch. They will supply power to any component whenever this unit is turned on.

The maximum power (total power consumption of components) that can be connected to these **SWITCHED AC OUTLETS** is 200 watts.

# OPERATION

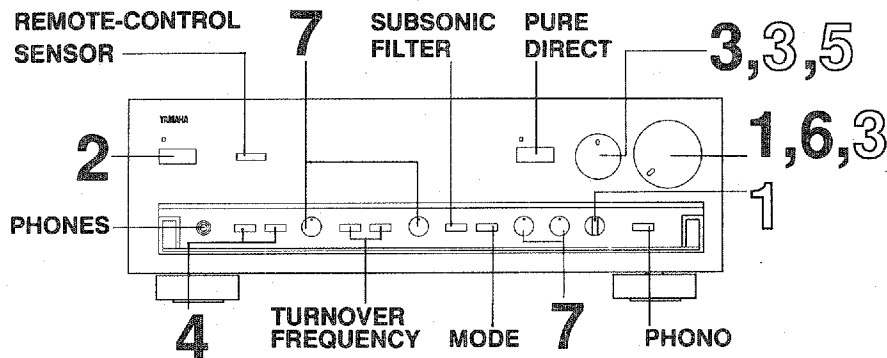

## To play a source

- 1**

Set to the "∞" position.
- 2**
- 3** Select the source you want to listen to.

If you select turntable as an input source (PHONO position), refer to "Setting the PHONO switch" on the page 7.
- 4** Select the speaker system to be used by pressing the **SPEAKERS** switches.  
(Refer to the next page for details.)
- 5** Play the source.
- 6**

Adjust to the desired output level.

**7** If desired, adjust the **BASS, TREBLE, BALANCE** and **LOUDNESS** controls, etc.  
(Refer to the next page for details.)

## To record a source to tape (or dub from a tape to another)

- 1** Select the source to be recorded.
- 2** Play the source.
- 3** Confirm the source by selecting it with the **INPUT** selector and turning up the **VOLUME** control.
- 4** Set the tape deck (or DAT) in the recording mode.
- 5** If your tape deck has three head monitoring capability, you can monitor the signal just recorded by selecting the corresponding tape deck.

\* Also, refer to the manual of the tape deck being used.

### Notes

- If you want to enjoy another source while recording, select it with the **INPUT** selector.
- Adjusting the **VOLUME, LOUDNESS, BASS, TREBLE** controls, **TURNOVER FREQUENCY** switch, **BALANCE** control, and **PURE DIRECT** switch during recording has no effect on the material being recorded.

F 80 1200

### Selecting the SPEAKER system

Because one or two speaker systems can be connected to this unit, the **SPEAKERS** switches allow you to select speaker system **A** or **B** or both at once.

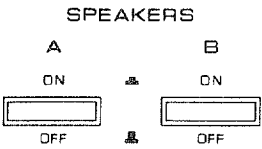

### Using the TURNOVER FREQUENCY switch

These switches can be used to adjust the turnover point of the tone controls: either 200 Hz or 400 Hz for **BASS** and either 2.5 kHz or 5 kHz for **TREBLE**. This gives you flexible control over bass and treble response characteristics.

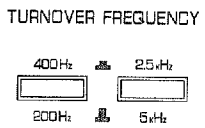

### Adjusting the BALANCE control

Adjust the balance of the output volume to the left and right speakers to compensate for sound imbalance caused from the speaker settings or the listening room condition.

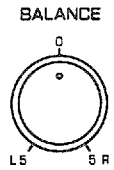

### Setting the PHONO switch

Select either **MM** or **MC** position depending on your PHONO cartridge, Moving Magnet or Moving Coil type. However, if you use a high output MC cartridge, select the **MM** position.

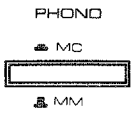

### Adjusting the BASS and TREBLE controls

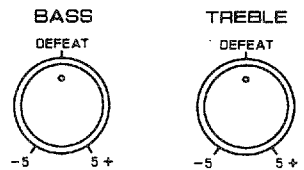

### Setting the SUBSONIC FILTER switch

If you set the switch to the **ON** position, ultra-low-frequency signals caused by turntable rumble or warped records can be cut out without losing sound quality.



- BASS:** Turn this clockwise to increase (or counterclockwise to decrease) the low frequency response.
- TREBLE:** Turn this clockwise to increase (or counterclockwise to decrease) the high frequency response.

### Setting the MODE switch

This switch can be used for switching between stereo and monaural operation. Normally this switch should be set to the **STEREO** position.

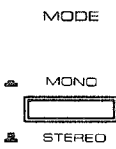



### Adjusting the continuous LOUDNESS control

This control provides compensation for the human ears' loss of sensitivity to high and low-frequency ranges at low volume. This control is adjustable to retain full tonal range at any volume level.

1

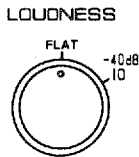

Set to the "FLAT" position.

2

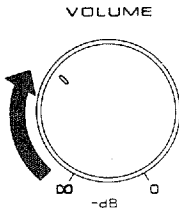

Set to the loudest listening level that you would listen to.

3

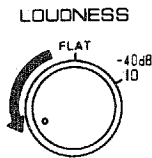

Turn so that the desired volume level can be achieved.

### Using the PURE DIRECT switch

You can enjoy purer source sound by setting this switch so that the indicator illuminates. Because, by doing so, the input signal is output directly, bypassing the **BASS, TREBLE, BALANCE** controls, **TURNOVER FREQUENCY** switch, **LOUDNESS** control, **SUBSONIC FILTER, MODE** switches and **PRE OUT/MAIN IN** terminals, therefore avoiding any "muddying" caused by circuit routing.

PURE  
 DIRECT



### When you listen with headphones

Connect the headphones to the **PHONES** jack. When listening with the headphones privately, set both the **SPEAKERS A** and **B** switches to the **OFF** position.

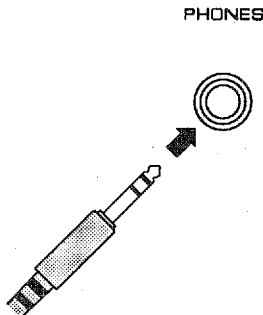



# REMOTE-CONTROL TRANSMITTER

The remote-control transmitter provided with this unit is designed to control all the most commonly used functions of the unit. If the CD player, turntable, equalizer, tuner, and tape deck connected to this unit are YAMAHA components designed for remote control compatibility (components with an *ERS* mark), then this remote-control transmitter will also control various functions of each component. Please consult YAMAHA dealer for information on which components are compatible with the remote-control transmitter.

## KEY FUNCTIONS

### For Amplifier Control

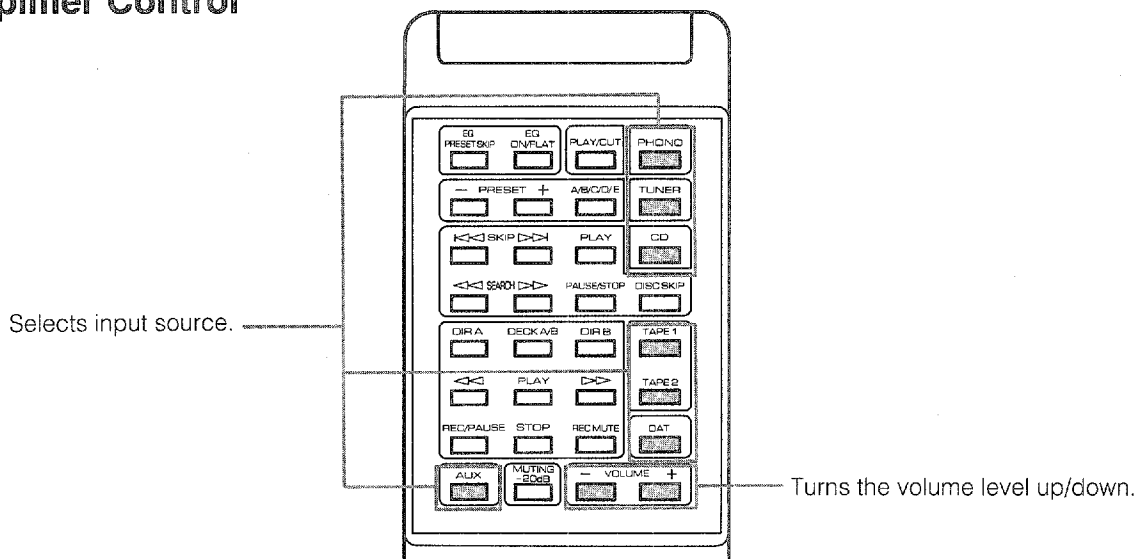

### For Other Component Control

Identify the remote-control transmitter keys with your component's keys. If these keys are identical, their function will be the same. On each key function, refer to the corresponding instruction on your component's manual.

Controls equalizer

- \* **PRESET SKIP** selects any preset equalizer curve whenever this is pressed. (After the last preset curve is selected, it returns to the first one by another press on this key.)

Controls compact disc player.

- \* **DISC SKIP** is applicable only to compact disc auto changer.

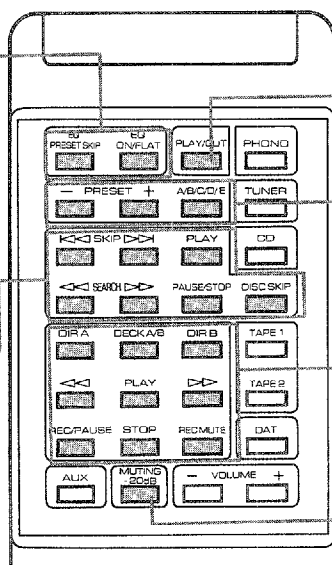

Starts/stops record play on turntable.

Selects preset station number.

- \* +: Selects higher preset station number.
- : Selects lower preset station number.

Controls tape deck.

- \* **DIR A, B** and **DECK A/B** are applicable only to double cassette tape deck.

Mutes the master volume level (**VOLUME**) by 20 dB. (The indicator on the **VOLUME** control knob blinks to show muting is on).

# NOTES ABOUT THE REMOTE-CONTROL TRANSMITTER

## Battery installation

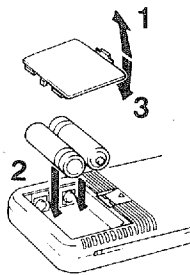

## Battery replacement

If the remote-control transmitter must be used closer to the main unit, the batteries are weak. Replace both batteries with new ones.

## Notes

- Use only "AA" (R6) batteries for replacement.
- Be sure the polarities are correct. (See the illustration inside the battery compartment.)
- Remove the batteries if the remote-control transmitter will not be used for an extended period of time.
- If batteries leak, immediately dispose of them. Avoid touching the leaked material or letting it come in contact with clothing, etc. Clean the battery compartment thoroughly before installing new batteries.

## Remote-control transmitter operation range

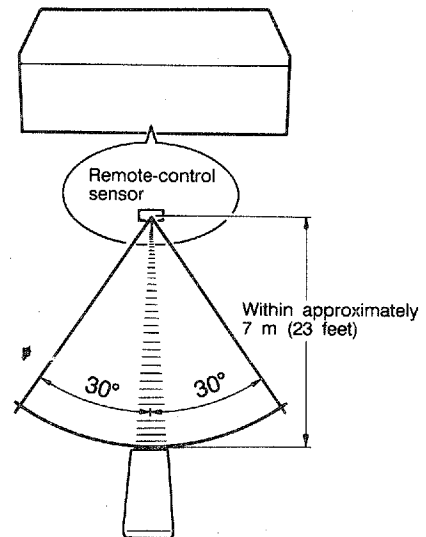

## Notes

- There should be no large obstacles between the remote-control transmitter and the main unit.
- If the remote control sensor is directly illuminated by strong lighting (of an inverter type of fluorescent lamp etc.), it may happen that the remote-control transmitter does not work correctly. In this case, change the position of the main unit to avoid being lit directly.

# TROUBLESHOOTING

If the unit fails to operate normally, check the following points to determine whether the fault can be corrected by the simple measures suggested. If it cannot be corrected, or if the fault is not listed in the SYMPTOM column, disconnect the power cord and contact your authorized YAMAHA dealer or service center for help.

SYMPTOM	CAUSE	REMEDY
Power is not supplied even though the POWER switch is ON.	The power plug is not securely connected.	Connect it securely.
There is no sound when any input source is selected with the input selector.	The correct SPEAKERS switch is not set.	Use the correct SPEAKERS switch.
	The input wires are not connected securely.	Connect them securely.
	The speaker systems are not connected correctly.	Check and secure the connections.
There is no sound from one speaker.	The speaker connections are not secure.	Secure the connections.
	The BALANCE control is set all the way to the left or right.	Adjust the BALANCE control correctly.
Sound level is low.	The LOUDNESS control is functioning.	Set the LOUDNESS control to the FLAT position.
	The MUTING key is set on. (When this key is on, the indicator on the VOLUME control is blinking.)	Press the MUTING key on the remote-control transmitter to set the key off.
There is a lack of bass, and no ambience.	The + and - wires are connected in reversed at the amplifier or speakers.	Connect the speaker wires in the correct phase (+ and -).
There is a humming sound when playing records.	The input wires are not connected securely.	Connect the input wires securely.
	The turntable's ground wire is not connected.	Connect the ground wire.
There is a howling sound when playing records at high volume.	The turntable and the speakers are too close together, or the turntable is not located on a firm surface.	Change the location of the turntable or the speakers.
Using the BASS, TREBLE, BALANCE controls, TURNOVER FREQUENCY switches, LOUDNESS control, SUBSONIC FILTER, MODE switches and the unit connected to the PRE OUT/MAIN IN terminals does not affect the tone.	The PURE DIRECT switch is ON.	The PURE DIRECT switch must be switched OFF to use the controls.
The sound suddenly stops.	Using outside the rated impedance range at high power for an extended period has activated the speaker protection circuit.	Switching this unit OFF and then ON will reset the speaker protection circuit. Use speakers within the rated impedance range.
	There is a malfunction in the amplifier.	Consult your Yamaha dealer.
The remote-control transmitter does not work.	Direct sunlight or lighting (of an inverter type of fluorescent lamp etc.) is striking the remote control sensor of the main unit.	Change position of the main unit.

# SPECIFICATIONS

Minimum RMS Output Power Per Channel  
 20 Hz - 20 kHz 0.01% THD 8Ω ..... 145W  
 20 Hz - 20 kHz 0.02% THD 6Ω ..... 185W  
 Dynamic Power Per Channel (by IHF  
 Dynamic Headroom Measuring Method)  
 8Ω/6Ω/4Ω/2Ω ..... 220W/290W/360W/460W  
 DIN Standard Output Power Per Channel  
 (European model)  
 1 kHz 0.7% THD 4Ω ..... 250W  
 Dynamic Headroom (General model)  
 8Ω ..... 1.81 dB  
 6Ω ..... 1.95 dB  
 IEC Power (European model)  
 1 kHz 0.01% THD 8Ω ..... 170W  
 Power Bandwidth  
 0.03% THD 72.5W 8Ω ..... 10 Hz - 50 kHz  
 Damping Factor  
 1 kHz 8Ω ..... 250 or more  
 Input Sensitivity/Impedance  
 Phono MC ..... 160 μV 220Ω  
 MM ..... 2.5 mV/47 kΩ  
 CD/TUNER/AUX/TAPE/DAT .. 150 mV/47 kΩ  
 MAIN IN ..... 1V/47 kΩ  
 Maximum Input level (1 kHz 0.01% THD)  
 Phono MC ..... 13.5 mV  
 MM ..... 170 mV  
 Output Level/Impedance  
 REC OUT ..... 150 mV 470Ω  
 PRE OUT ..... 1V/1.3kΩ  
 Maximum Voltage Output  
 20 Hz - 20 kHz 0.02% THD ..... 6.5V  
 Headphone Jack Rated Output/Impedance  
 0.015% THD RL=8Ω ..... 1.05V/220Ω

Frequency Response  
 CD/TUNER/AUX/TAPE/DAT  
 ..... 20 Hz - 20 kHz, 0±0.5 dB  
 MAIN IN ..... 20 Hz - 20 kHz, 0±0.5 dB  
 RIAA Equalization Deviation 20 Hz - 20 kHz,  
 Phono MC ..... ±0.5 dB  
 MM ..... ±0.3 dB  
 Total Harmonic Distortion 20 Hz - 20 kHz  
 Phono MC to REC OUT, 3V ..... 0.007%  
 MM to REC OUT, 3V ..... 0.003%  
 CD/TUNER/AUX/TAPE/DAT to  
 Pre Out, 1V ..... 0.004%  
 CD/TUNER/AUX/TAPE/DAT to Sp Out,  
 72.5W/8Ω ..... 0.007%  
 MAIN IN to Sp Out, 72.5W/8Ω ..... 0.005%  
 Intermodulation Distortion  
 CD/TUNER/AUX/TAPE/DAT  
 Rated Output/8Ω ..... 0.005%  
 Signal-to-Noise Ratio (IHF-A Network)  
 (Pure Direct Switch: ON)  
 Phono MC (500 μV Input Shorted) ..... 75 dB  
 MM (5 mV Input Shorted) ..... 92 dB  
 CD/AUX/DAT (Shorted) ..... 110 dB  
 TUNER/TAPE (Shorted) ..... 106 dB  
 Residual Noise (IHF-A Network)  
 (Pure Direct Switch: ON) ..... 35 μV  
 Channel Separation Vol - 30 dB  
 Phono MC, MM Input shorted  
 1 kHz/10 kHz ..... 70 dB/55 dB  
 CD/TUNER/AUX/TAPE/DAT  
 Input 5.1 kΩ  
 Terminated 1 kHz/10 kHz ..... 65 dB/50 dB

Tone Control Characteristics  
 Bass  
 Boost / Cut ..... ±10 dB (20 Hz)  
 Turnover frequency ..... 220, 400 Hz  
 Treble  
 Boost / Cut ..... ±10 dB (20 kHz)  
 Turnover frequency ..... 2.5, 5 kHz  
 Filter Characteristics (Subsonic)  
 ..... 15 Hz, -18 dB/oct  
 Continuous Loudness Control (Level Related  
 Equalization)  
 Attenuation ..... -40dB (1 kHz)  
 Audio Muting ..... -20 dB  
 Gain Tracking Error (0 - -60 dB) ..... 2 dB  
 Power Supply  
 U.S.A. and Canadian models  
 ..... AC 120V/60 Hz  
 British and Australian models  
 ..... AC 240V/50 Hz  
 European model ..... AC 230V/50 Hz  
 General model  
 ..... AC 110/120/220/240V, 60/50 Hz  
 Power Consumption  
 British, Australian,  
 European and General models ..... 370W  
 AC Outlets  
 AC Outlets Switched (3)  
 (General Model) ..... 200W max.  
 Dimensions (W x H x D)  
 ..... 435 x 171 x 448 mm  
 (17-1/8" x 6-3/4" x 17-5/8")  
 Weight ..... 18.3 kg  
 (40 lbs. 4 oz.)  
 Accessories ..... Remote-control transmitter  
 Batteries

\* Specifications are subject to change without notice.